

**MTE I**  
**2015**

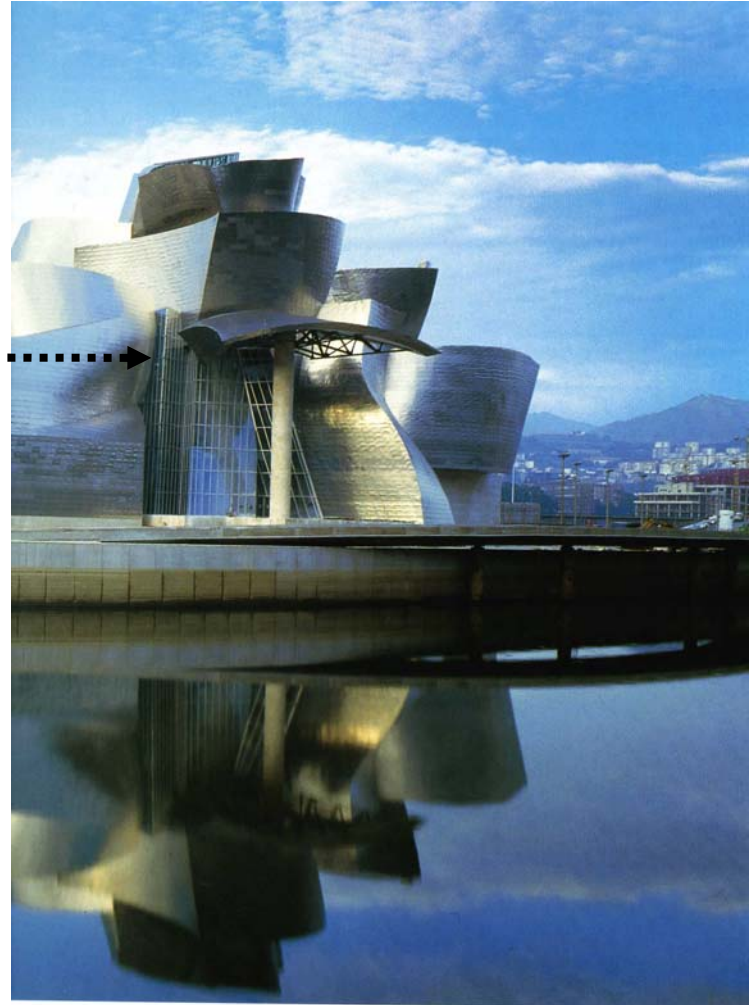

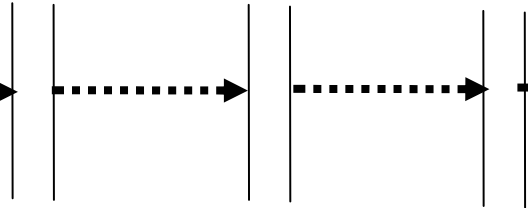
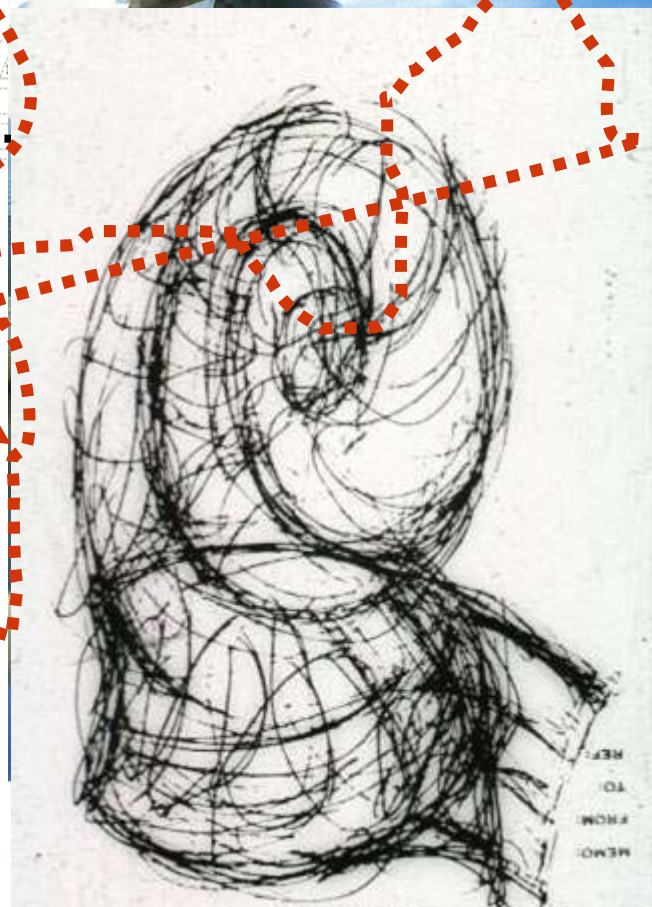
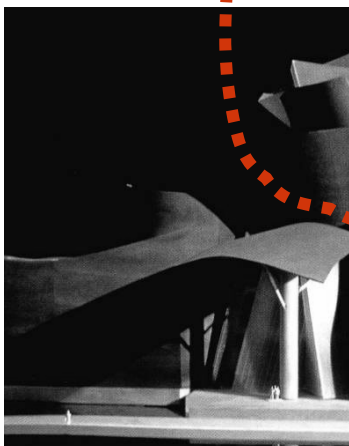
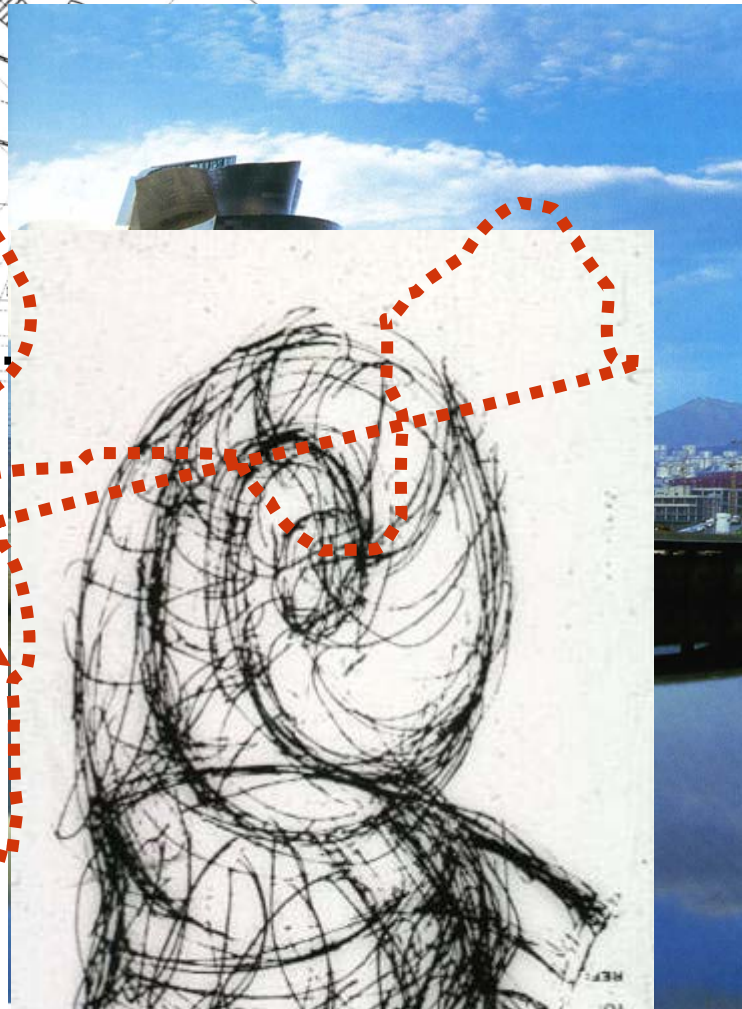
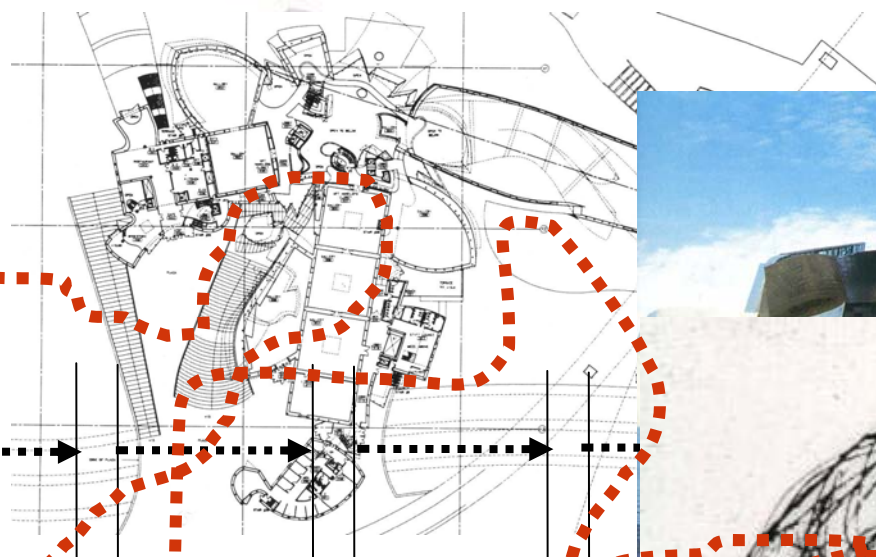

## PROYECCIONES CILÍNDRICAS O PARALELAS

## PROYECCIONES CÓNICAS

### DIÉDRICO ORTOGONAL

### AXONOMETRÍA

### PERSPECTIVA CÓNICA

LT



FACHADA



PLANTA

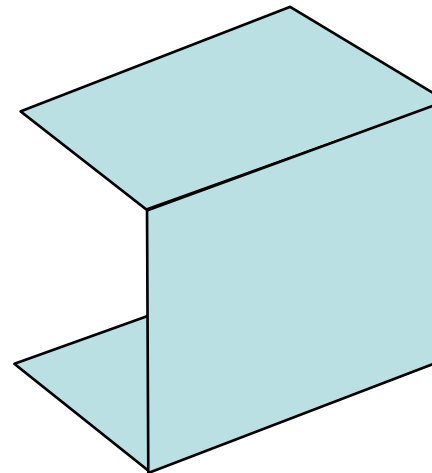

LH

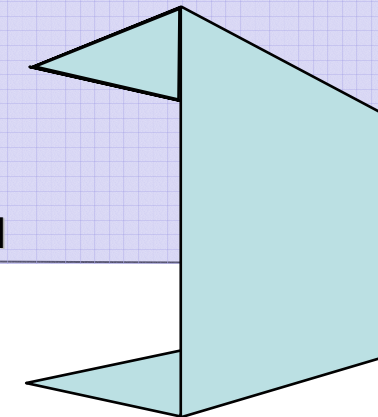

# PROYECCIONES CILÍNDRICAS O PARALELAS

DIÉDRICO ORTOGONAL

LT

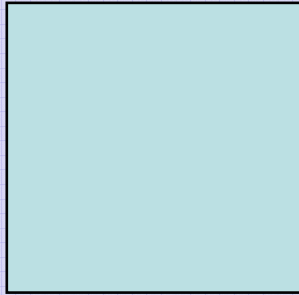

FACHADA



PLANTA TECHOS



FACHADA LATERAL 1



FACHADA LATERAL 2

# PROYECCIONES CILÍNDRICAS O PARALELAS

DIÉDRICO ORTOGONAL

LT

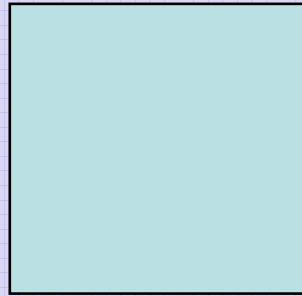

2

FACHADA



1

PLANTA TECHOS



FACHADA LATERAL 1



FACHADA LATERAL 2

3

# PROYECCIONES CILÍNDRICAS O PARALELAS

## DIÉDRICO ORTOGONAL

LT

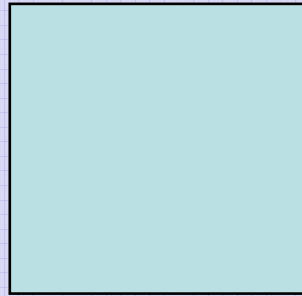

2

FACHADA



1

PLANTA TECHOS

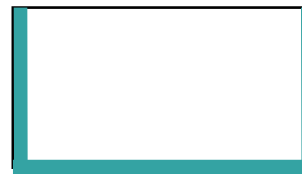

PLANTA



FACHADA LATERAL 1

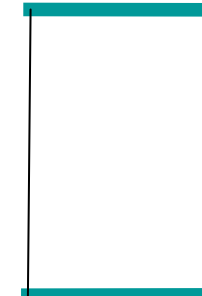

CORTE TRANSVERSAL 11

3

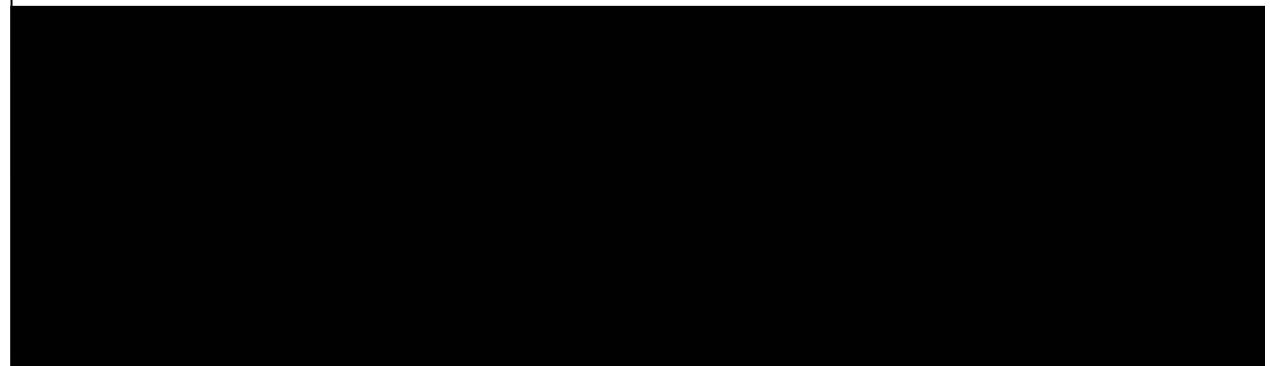

## PROYECCIONES CILÍNDRICAS O PARALELAS

## PROYECCIONES CÓNICAS

### DIÉDRICO ORTOGONAL

### AXONOMETRÍA

### PERSPECTIVA CÓNICA

LT



CORTE



PLANTA

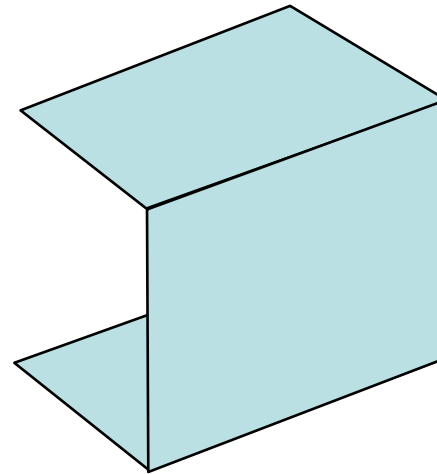

LH

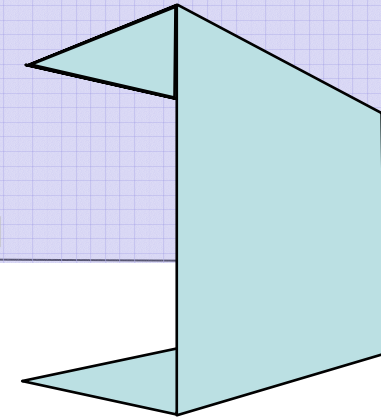



## PROYECCIONES CILÍNDRICAS O PARALELAS

## PROYECCIONES CÓNICAS

### DIÉDRICO ORTOGONAL

### AXONOMETRÍA

### PERSPECTIVA CÓNICA

LT

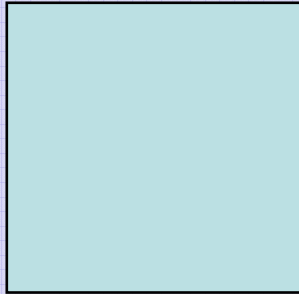

CORTE



PLANTA

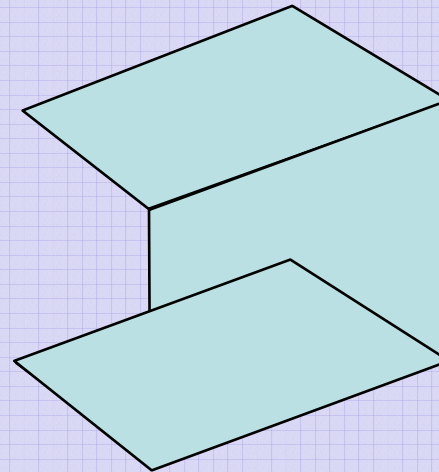

LH

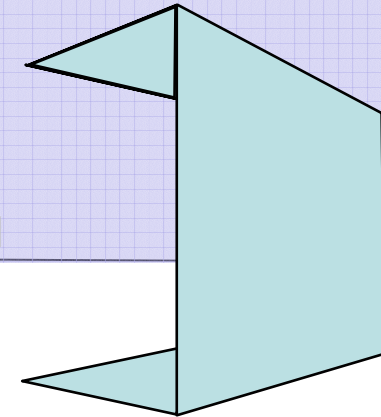

# AXONOMETRÍA

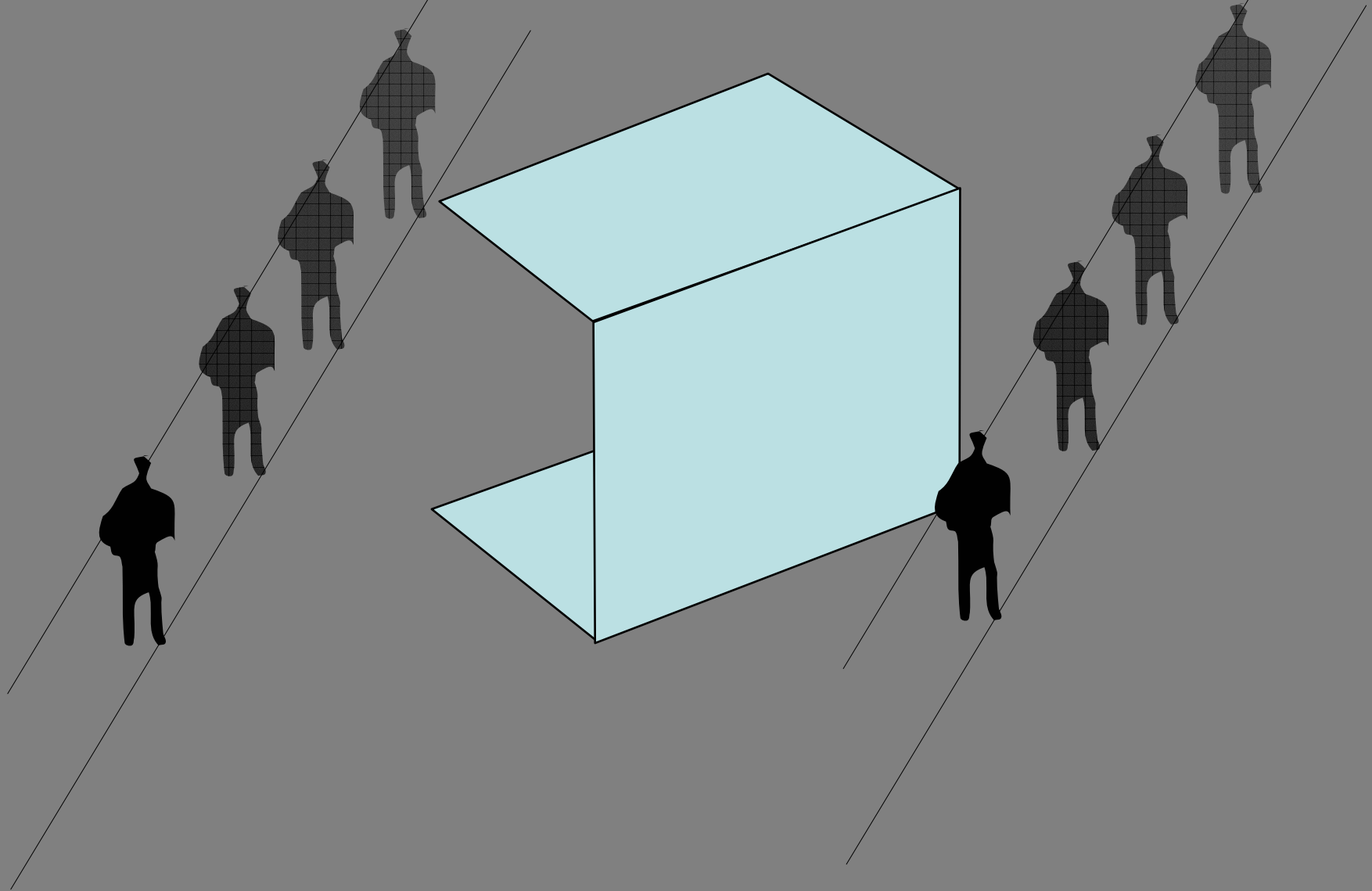

# PERSPECTIVA CÓNICA

LH

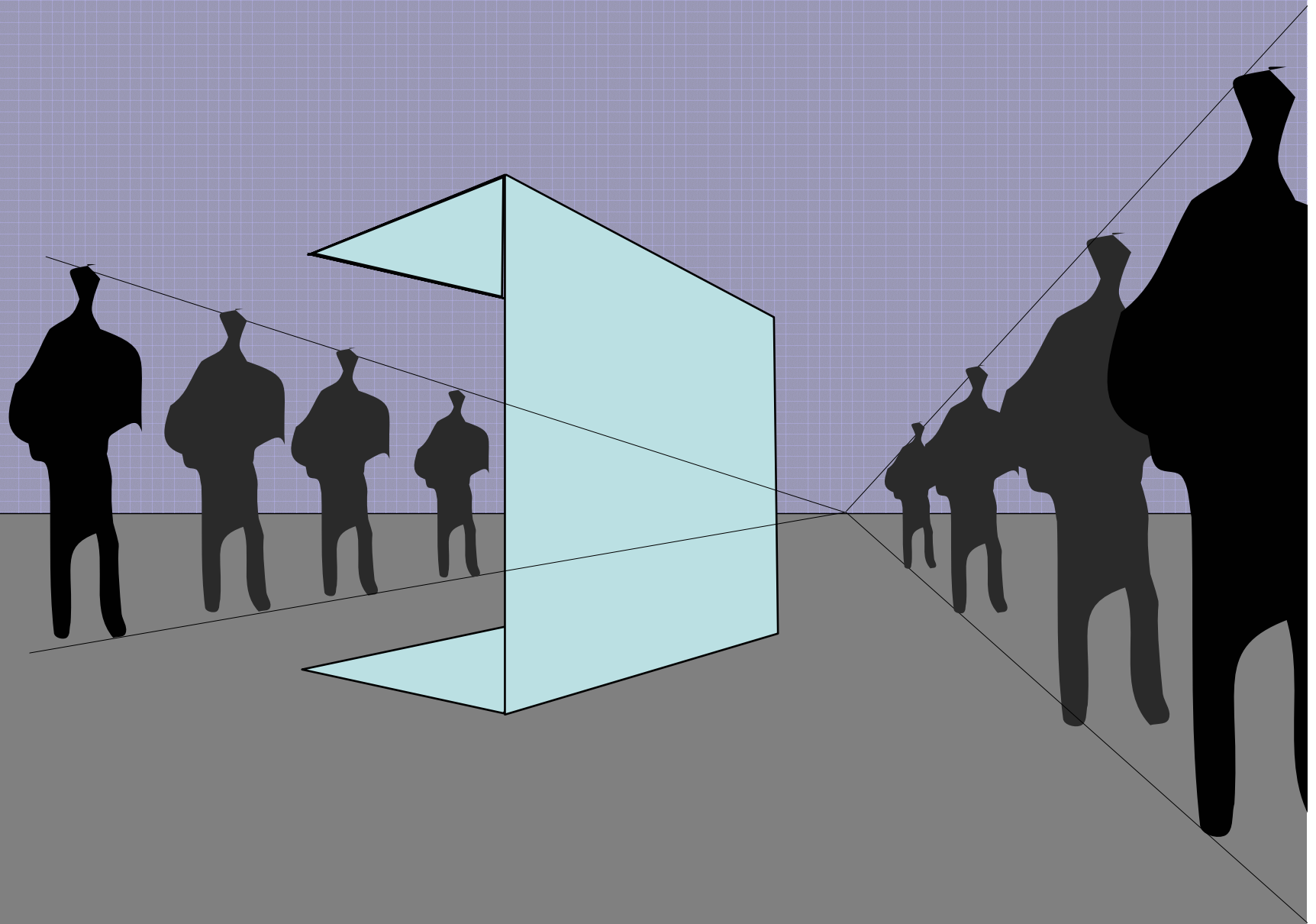

# DIÉDRICO ORTOGONAL

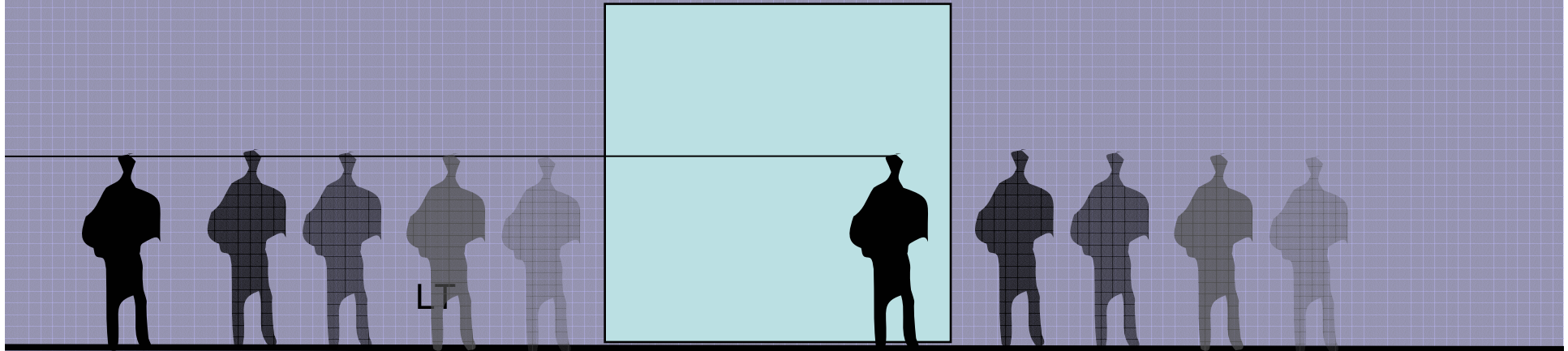

CORTE

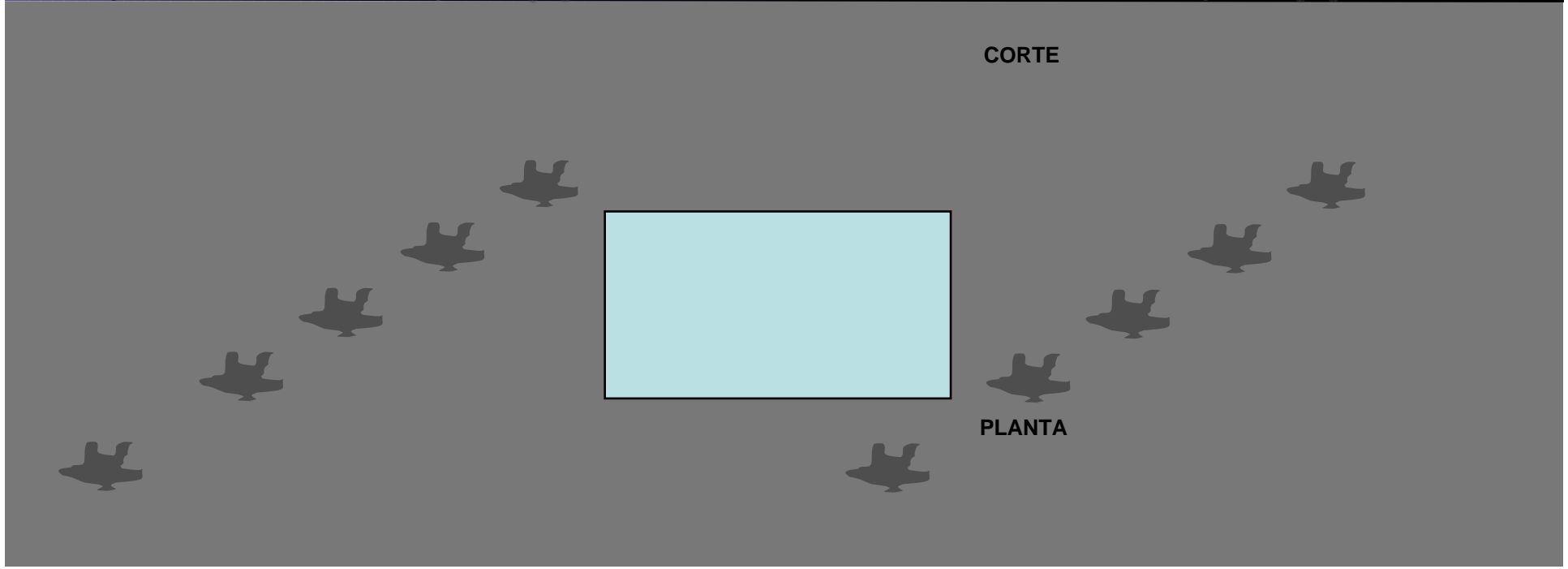

PLANTA

**PROYECCIONES**

**PROYECCIONES PARALELAS** (o cilíndricas)

**PROYECCIONES PARALELAS ORTOGONALES**

**SISTEMA DIÉDRICO ORTOGONAL** **SDO**

**OBJETO**

**PROYECTANTES**

**CUADRO O PLANO DE REPRESENTACIÓN**

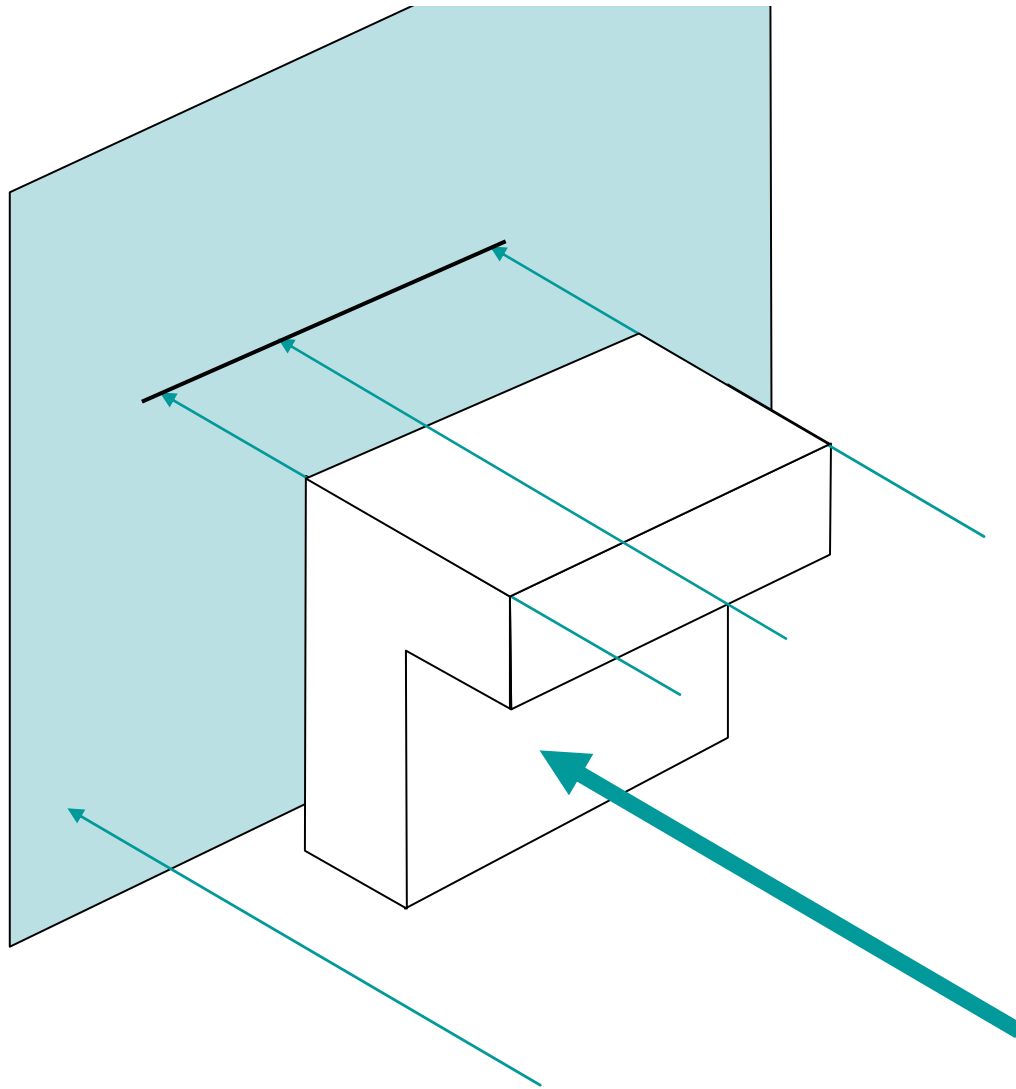

**PROYECCIONES PARALELAS  
O CILÍNDRICAS**

**PROYECCIONES  
ORTOGONALES**

proyectantes  
perpendiculares al plano  
de representación...

cualquiera sea la  
ubicación del objeto

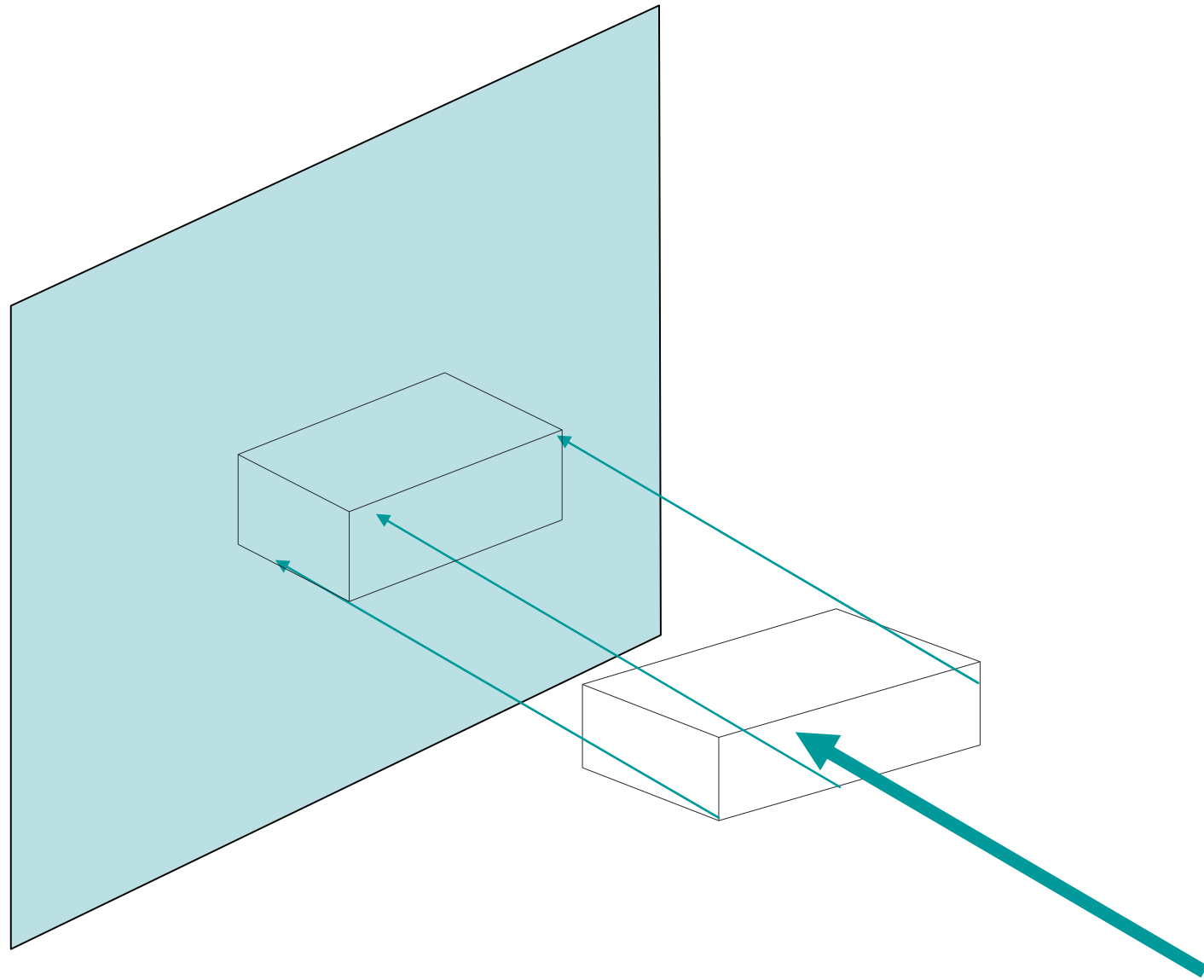

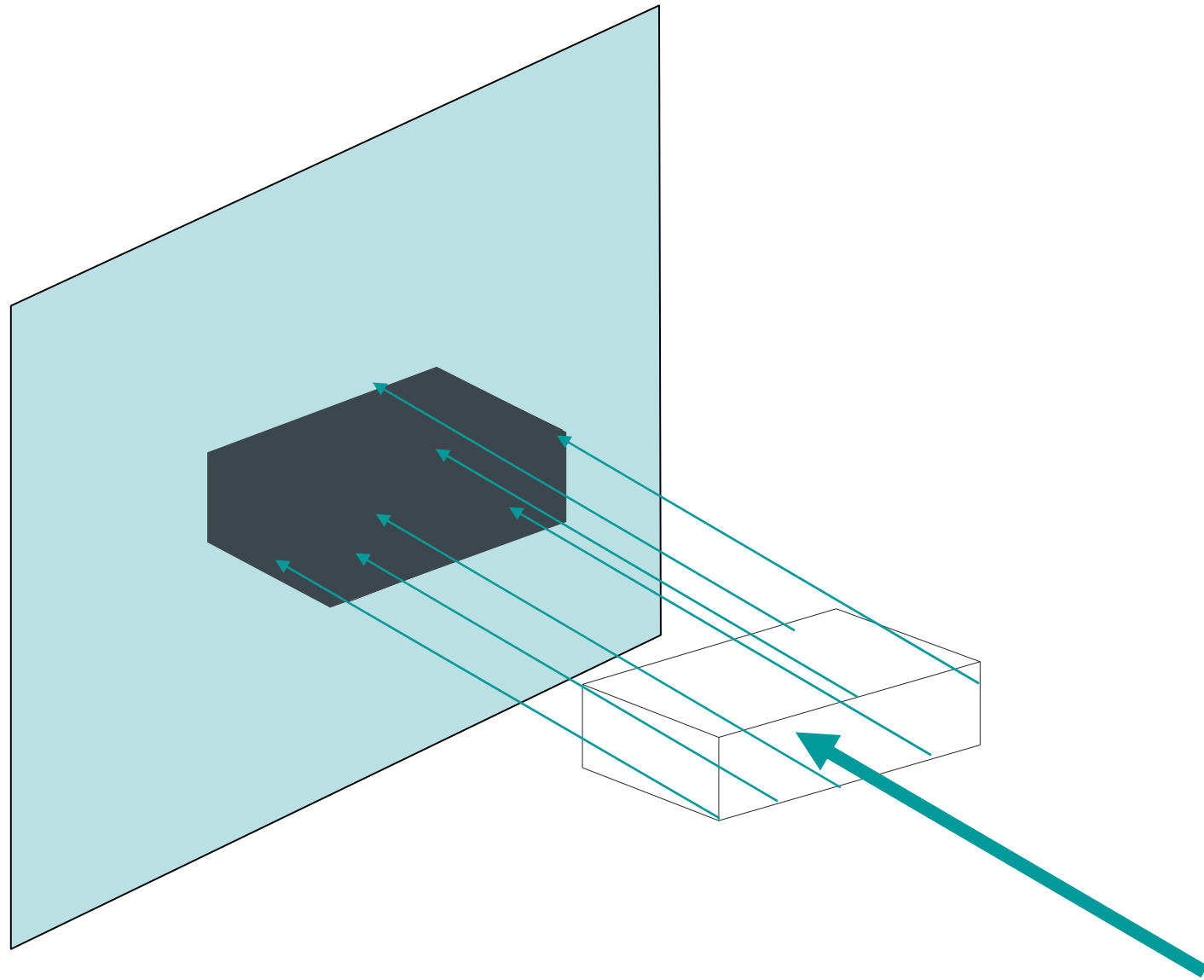



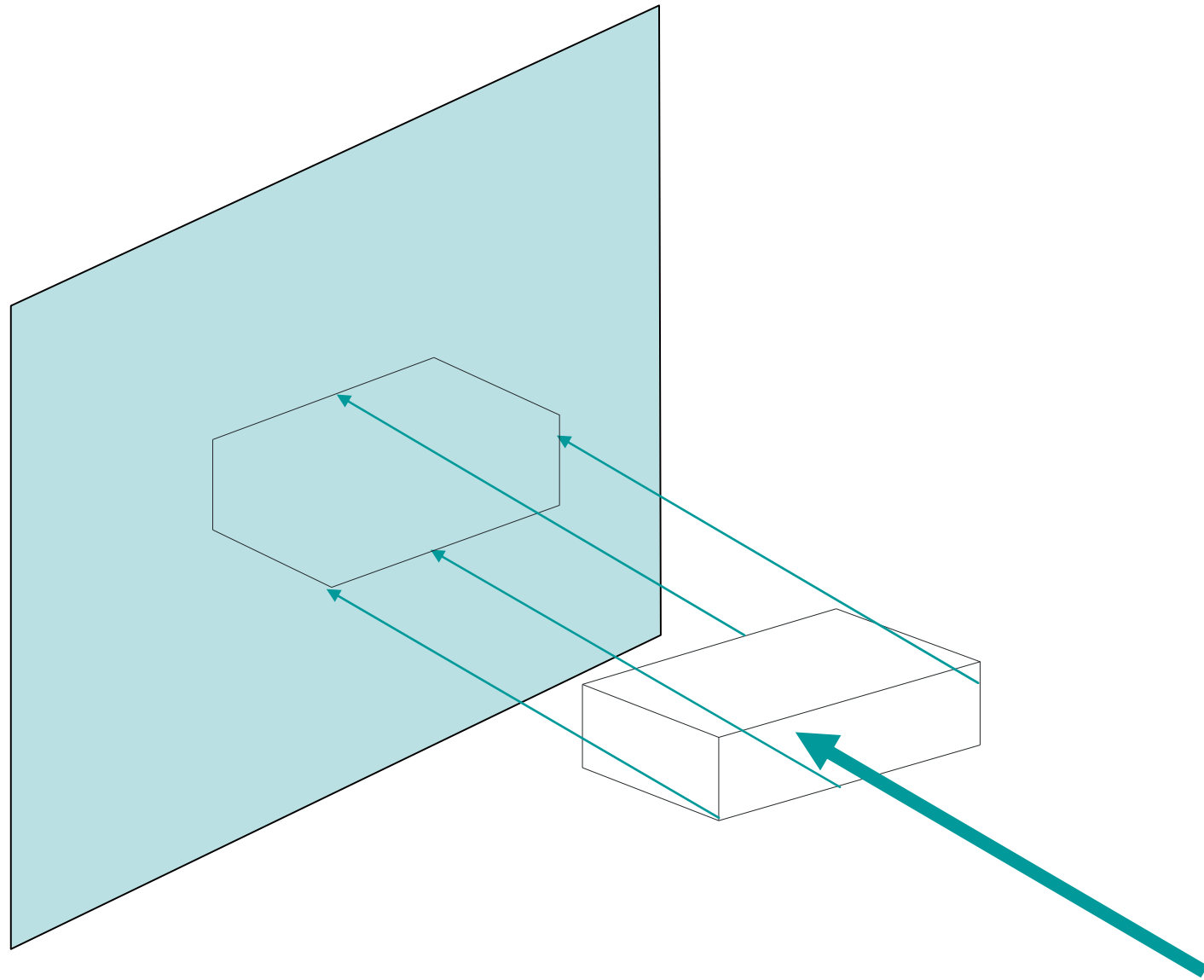

PERFIL – proyectantes tangentes al objeto

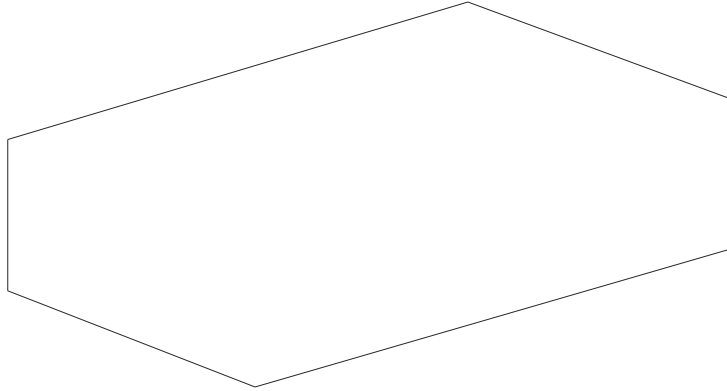

SILUETA – todas las proyectantes que pasan por el objeto

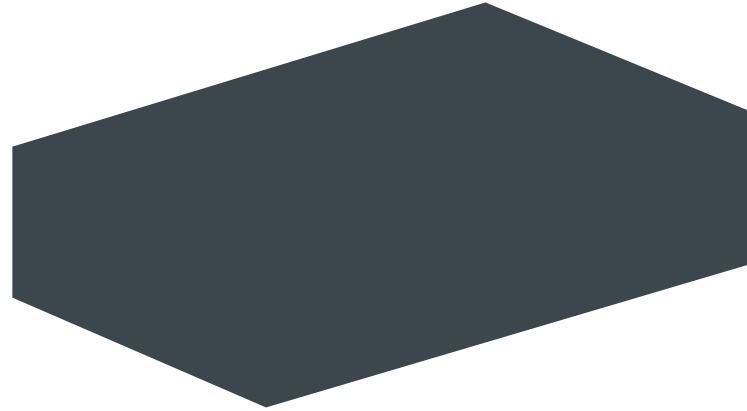

LINEAL - Aristas significativas

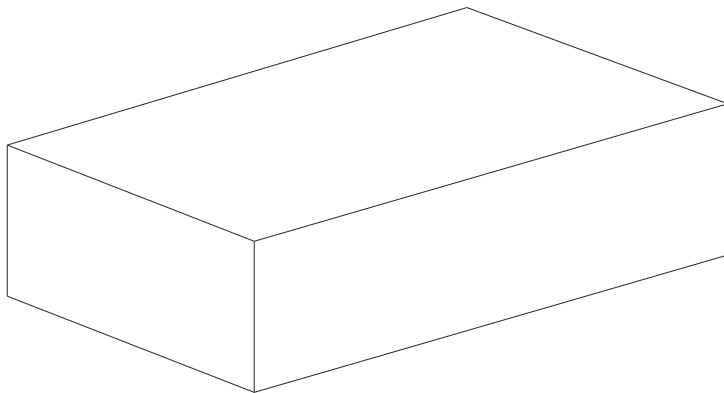

CLAROSCURO - Aristas significativas + luces y sombras

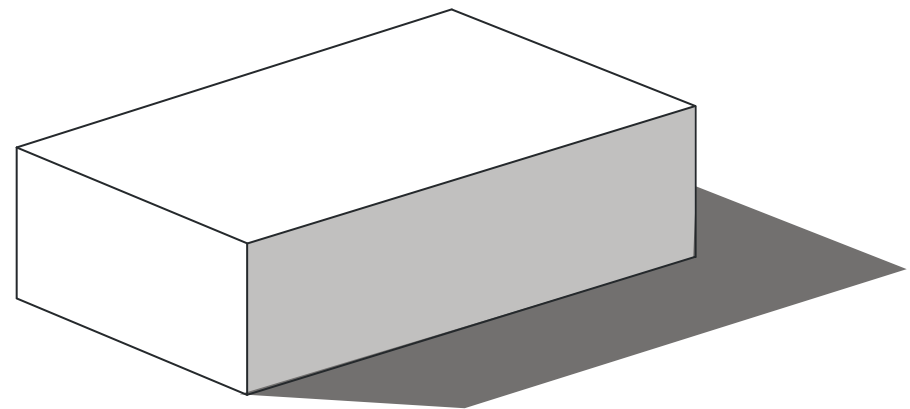

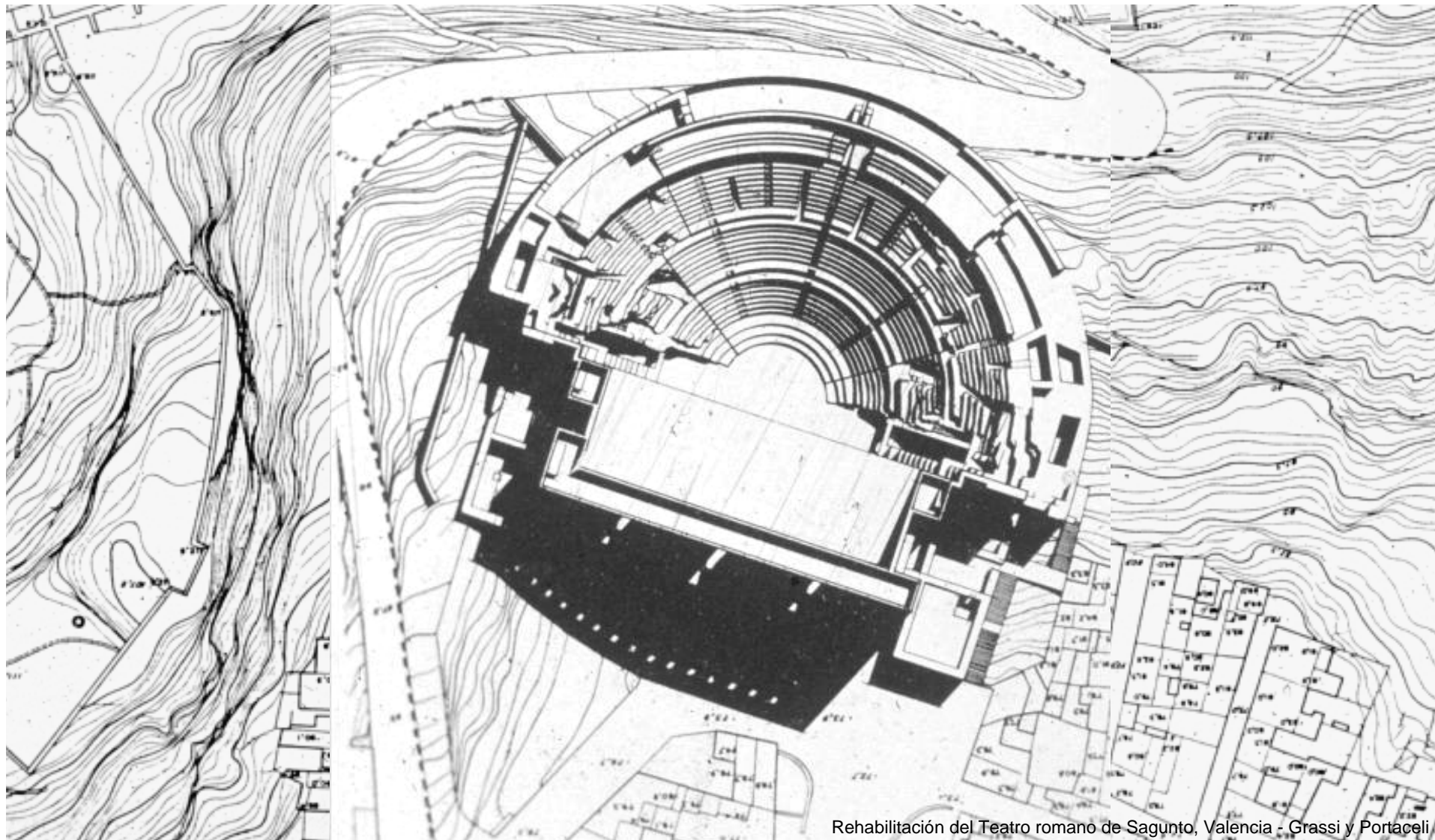

Rehabilitación del Teatro romano de Sagunto, Valencia - Grassi y Portaceli

EXPRESIÓN DE LAS SOMBRAAS EN PLANTA DE TECHOS

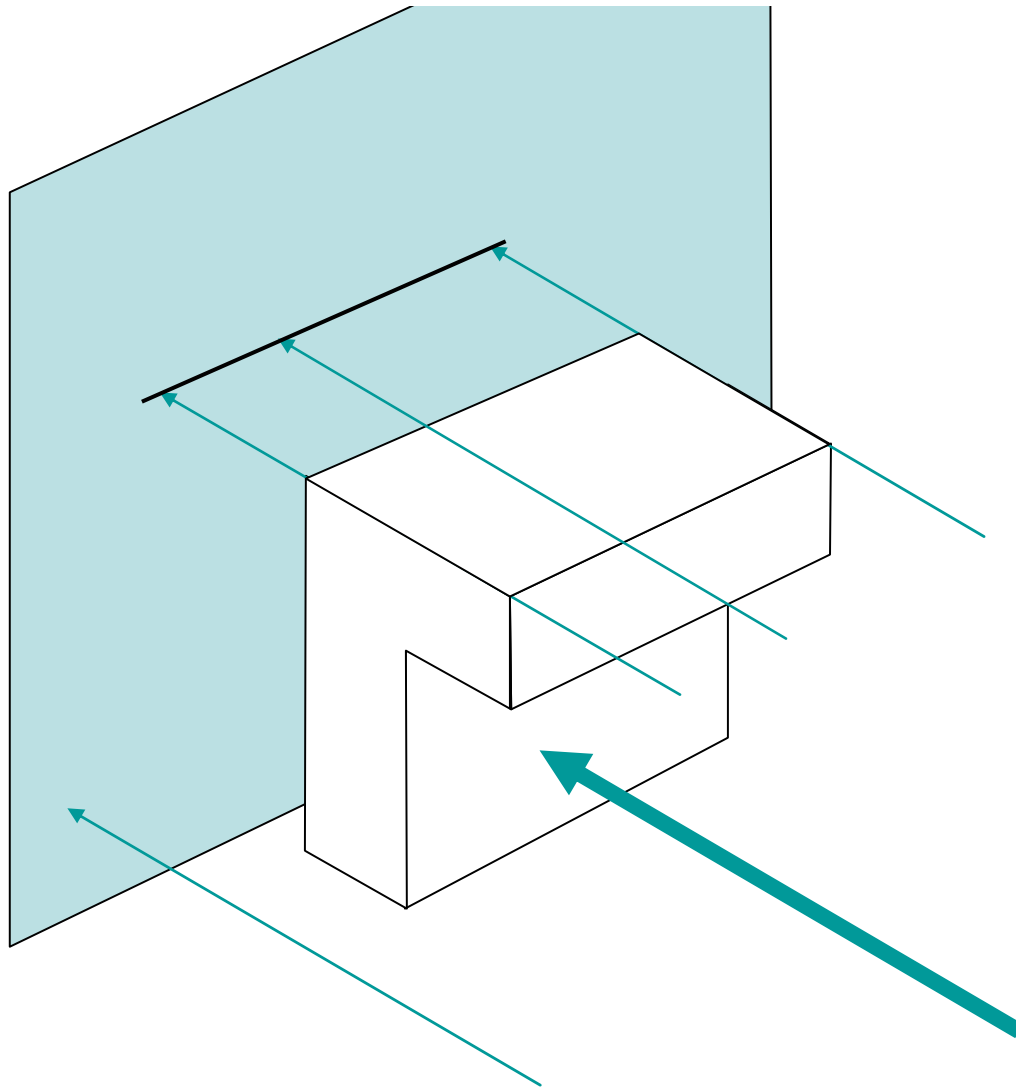

**PROYECCIONES PARALELAS  
O CILÍNDRICAS**

**PROYECCIONES  
ORTOGONALES**

proyectantes  
perpendiculares al plano  
de representación...

cualquiera sea la  
ubicación del objeto

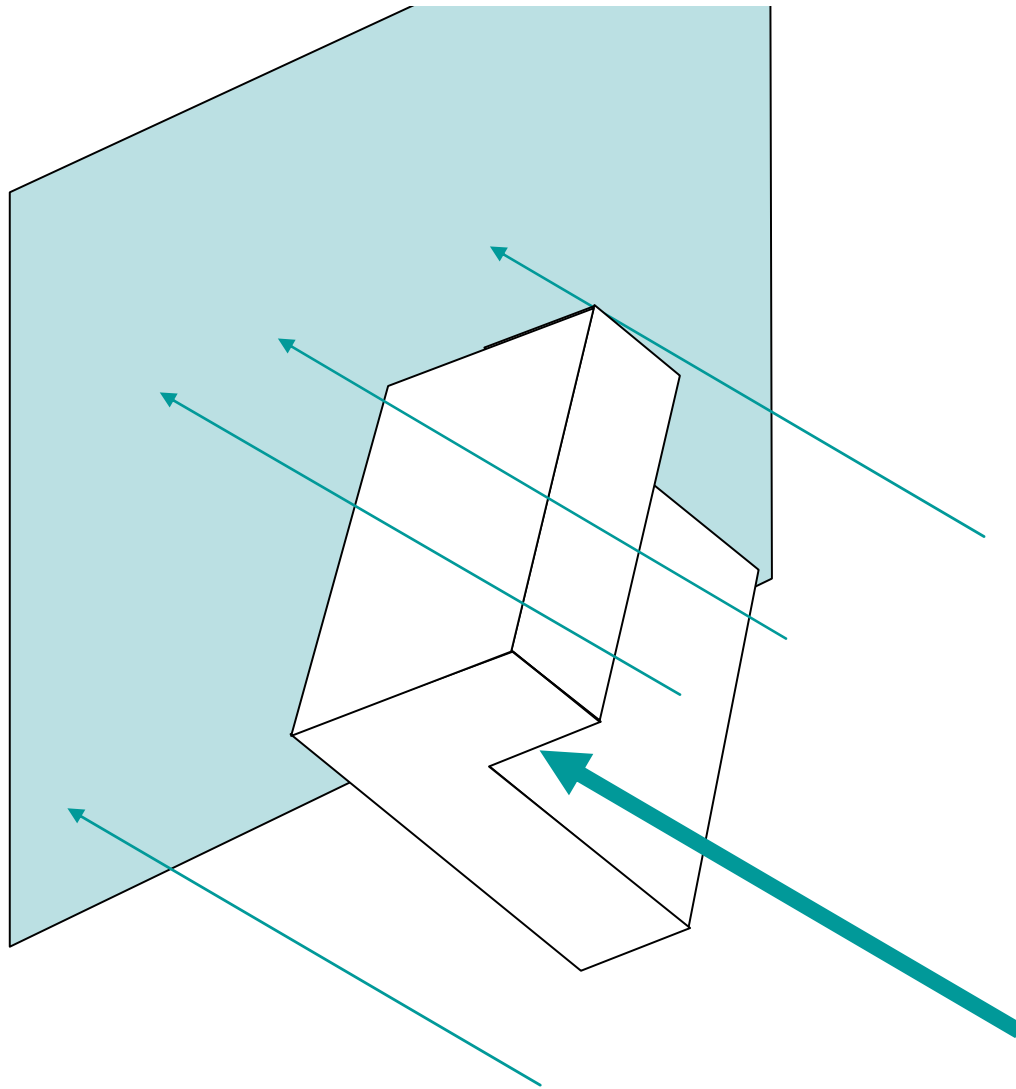

**PROYECCIONES PARALELAS  
O CILÍNDRICAS**

**PROYECCIONES  
ORTOGONALES**

proyectantes  
perpendiculares al plano  
de representación...

cualquiera sea la  
ubicación del objeto

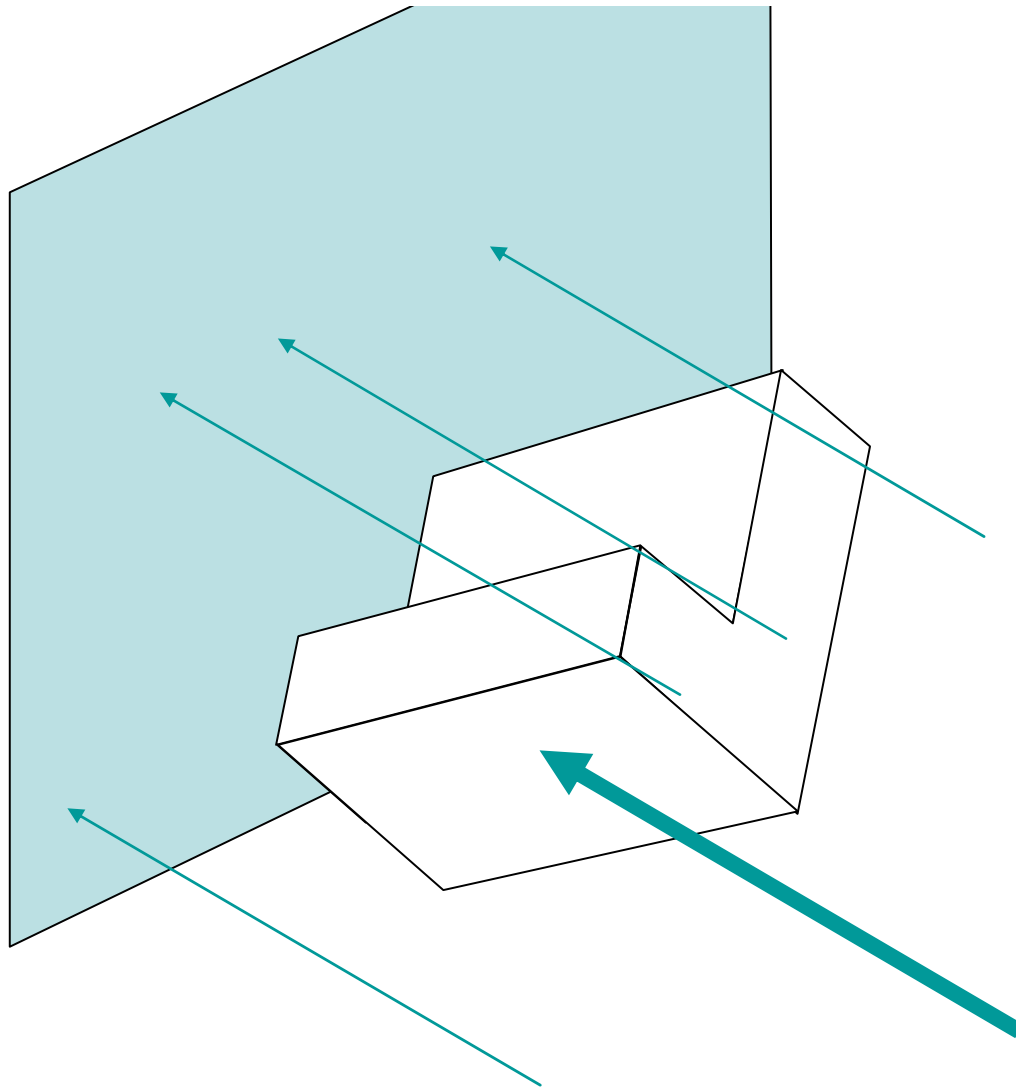

**PROYECCIONES PARALELAS  
O CILÍNDRICAS**

**PROYECCIONES  
ORTOGONALES**

proyectantes  
perpendiculares al plano  
de representación...

cualquiera sea la  
ubicación del objeto

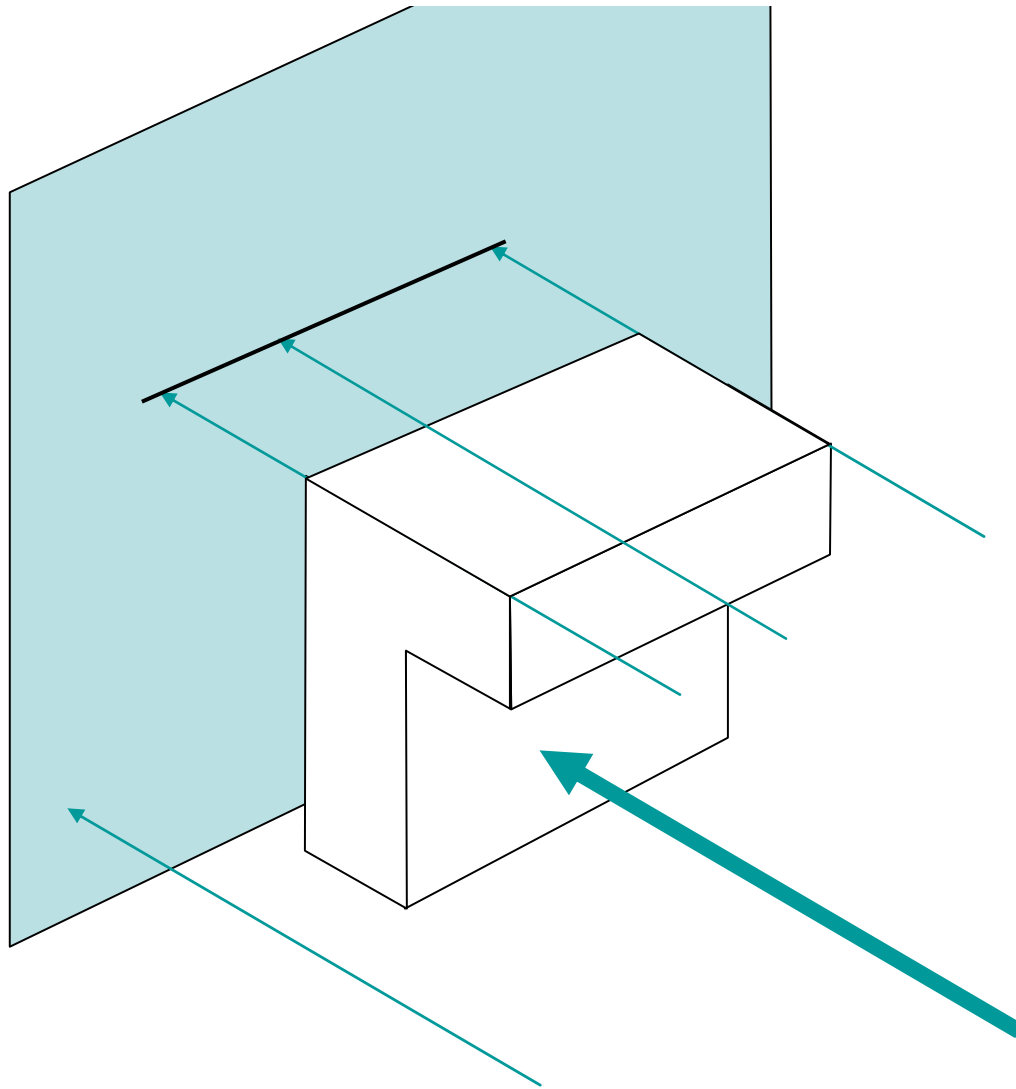

**PROYECCIONES PARALELAS  
O CILÍNDRICAS**

**PROYECCIONES  
ORTOGONALES**

proyectantes  
perpendiculares al plano  
de representación...

cualquiera sea la  
ubicación del objeto

PROYECCIONES PARALELAS  
O CILÍNDRICAS

LT

FACHADA

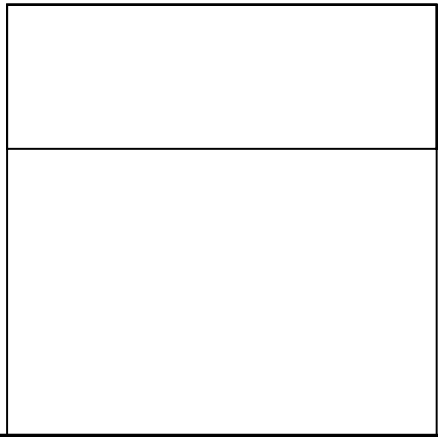

V''



V'

90°





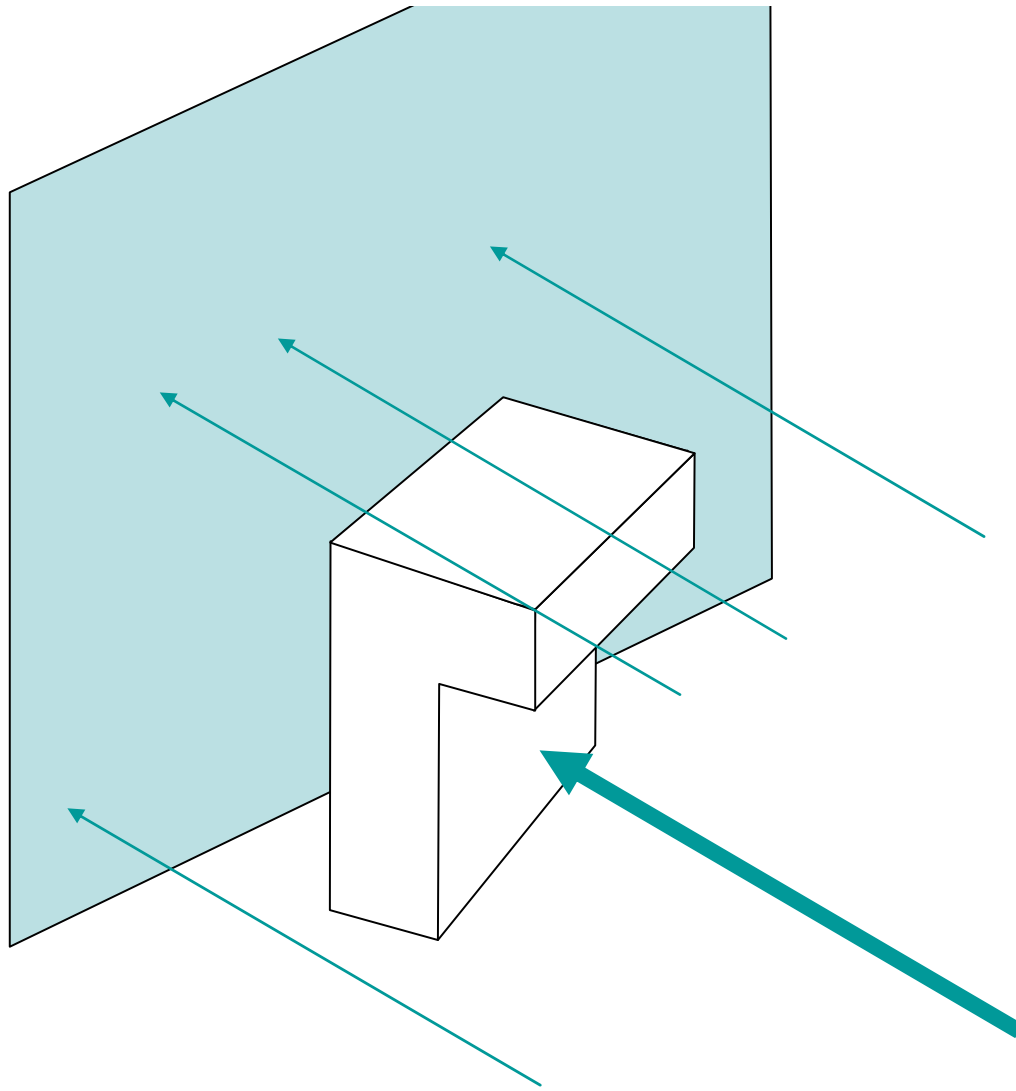

**PROYECCIONES PARALELAS  
O CILÍNDRICAS**

**PROYECCIONES  
ORTOGONALES**

proyectantes  
perpendiculares al plano  
de representación...

cualquiera sea la  
ubicación del objeto

PROYECCIONES PARALELAS  
O CILÍNDRICAS

LT

FACHADA

$V''$

$V'$

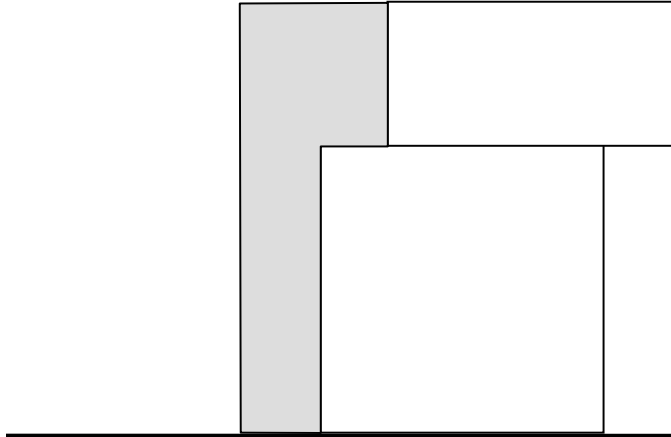

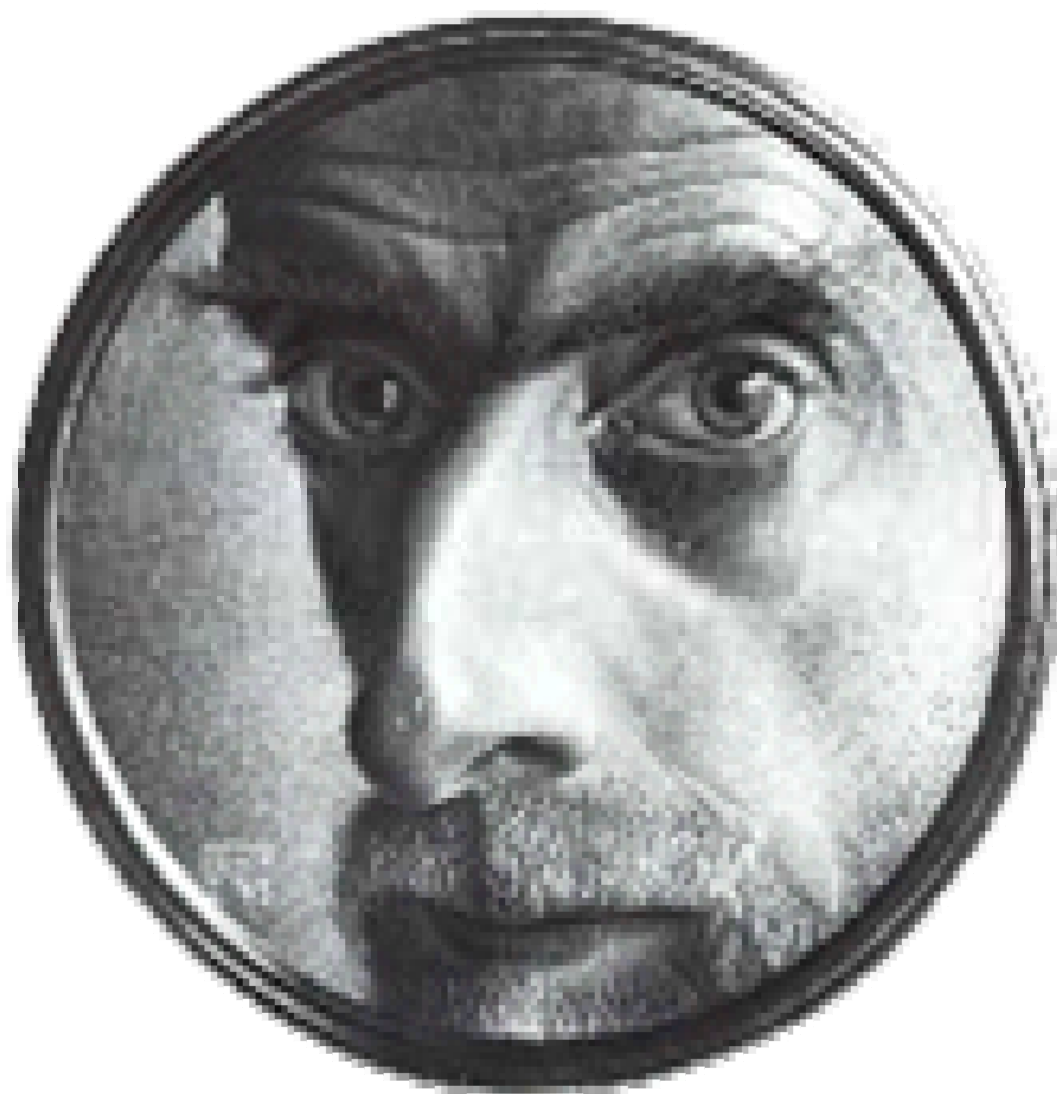

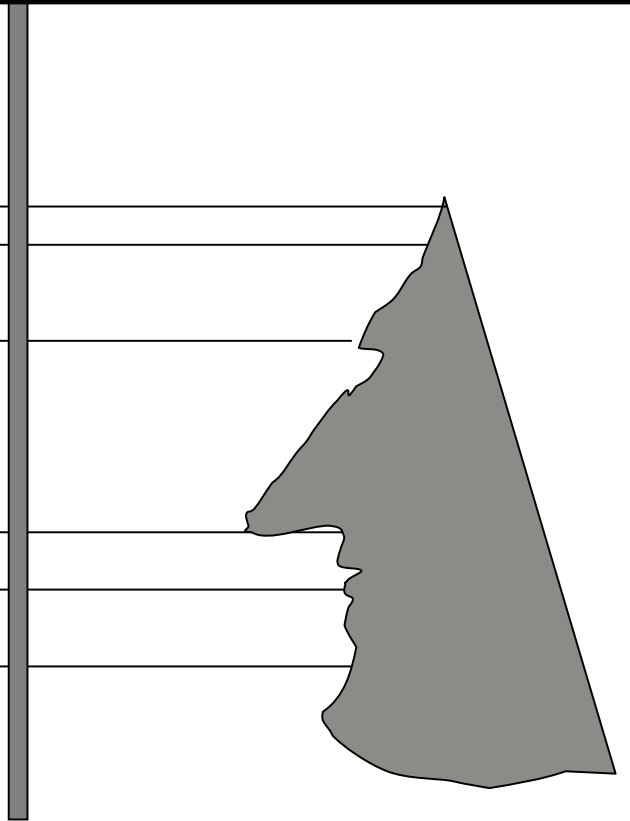

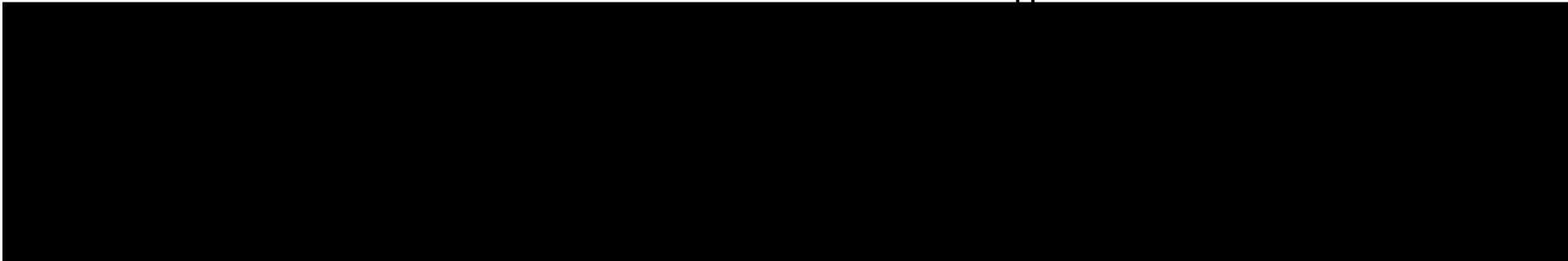
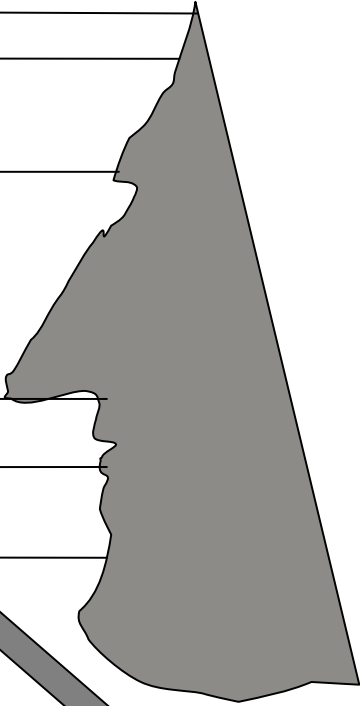
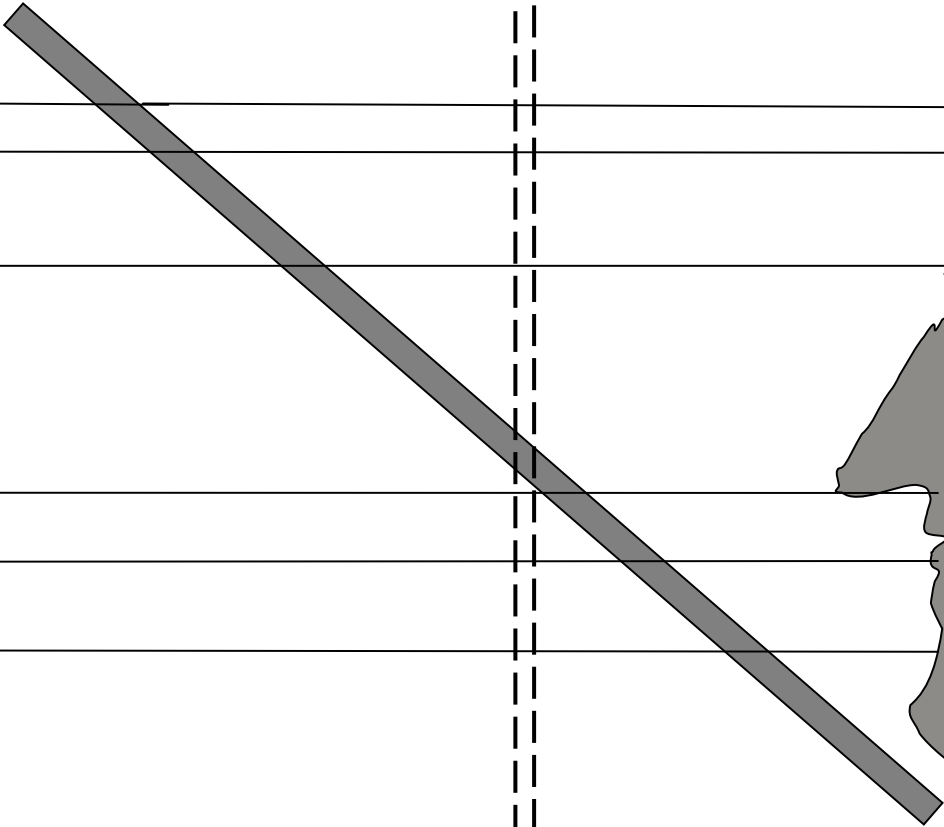



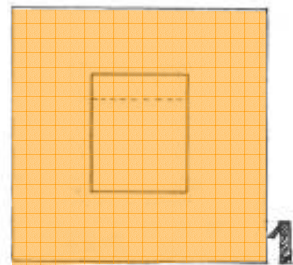
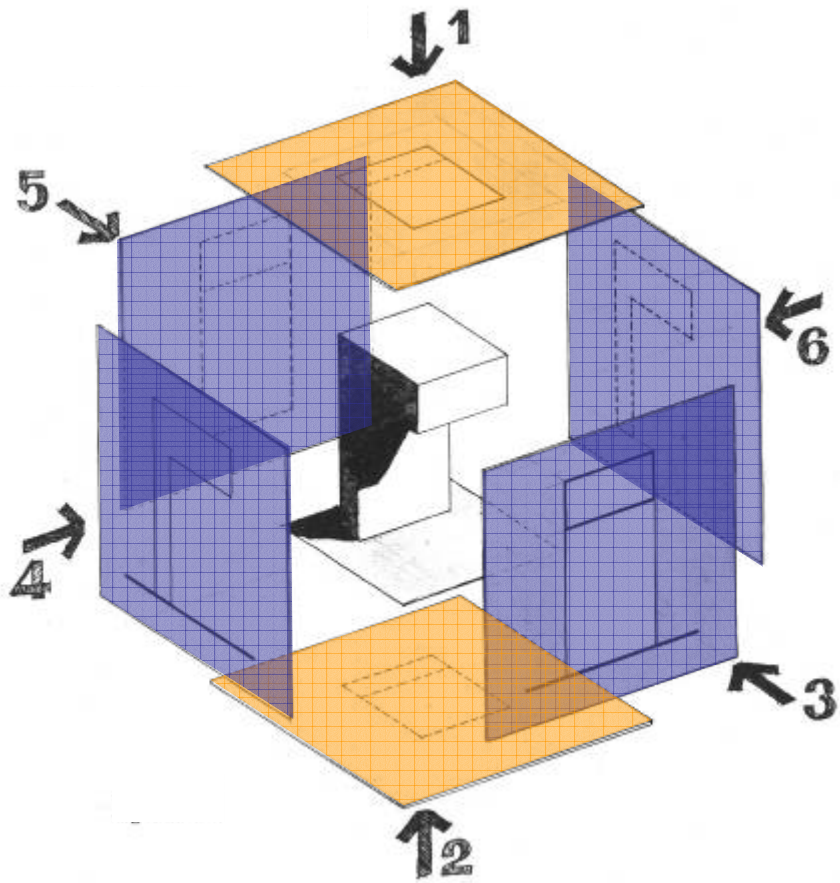

VISTA SUPERIOR-PLANTA

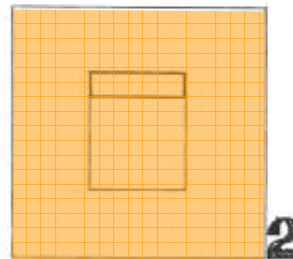

VISTA INFERIOR

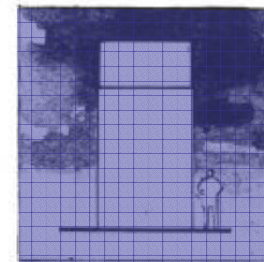

VISTA DE FRENTE

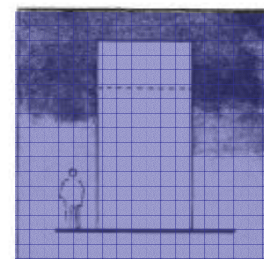

VISTA POSTERIOR

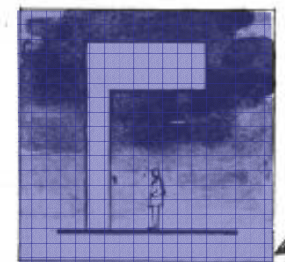

VISTA LATERAL

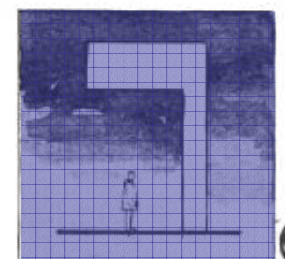

VISTA LATERAL

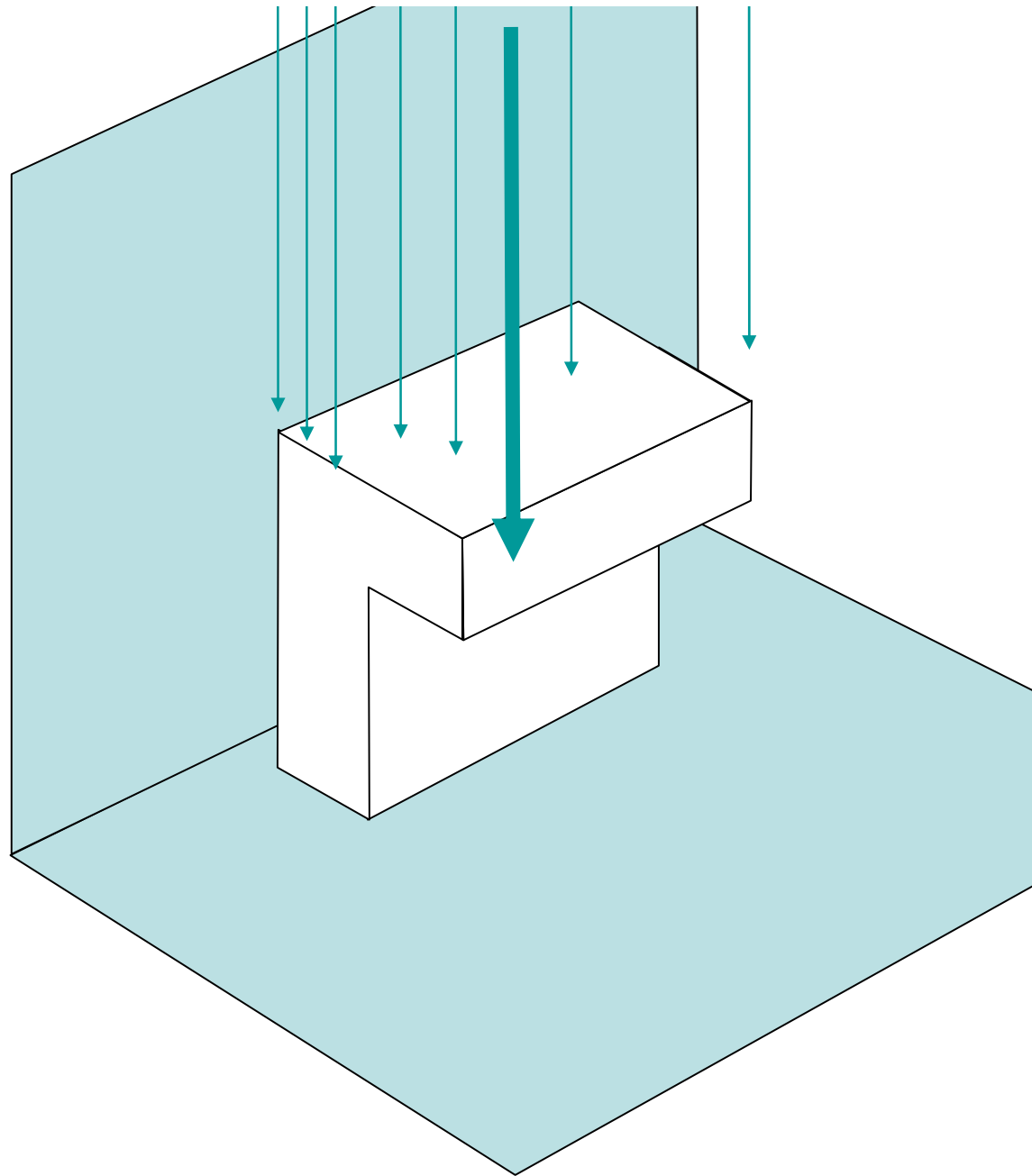

**PROYECCIONES PARALELAS  
O CILÍNDRICAS**

**PROYECCIONES  
ORTOGONALES**

proyectantes  
perpendiculares al plano  
de representación...

cualquiera sea la  
ubicación del objeto



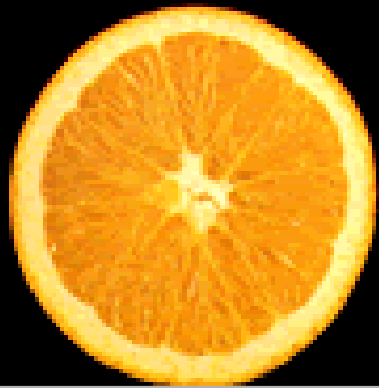

LT

CORTE 1

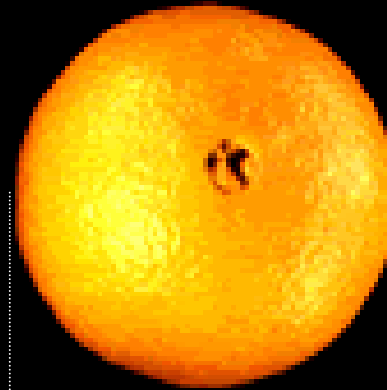

FACHADA

1

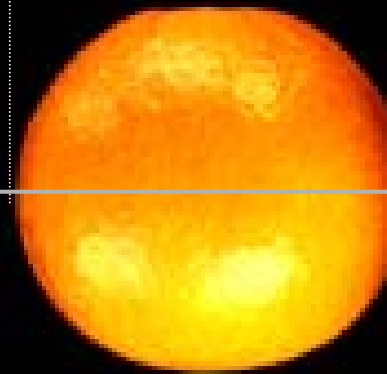

1

PLANTA TECHOS

A



B

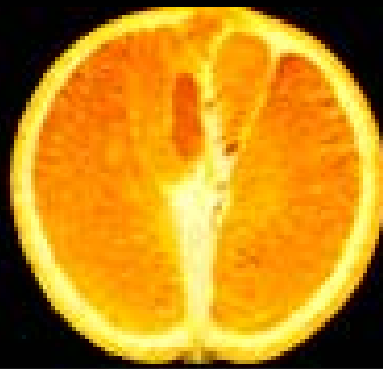

C



LT

CORTE 1

1

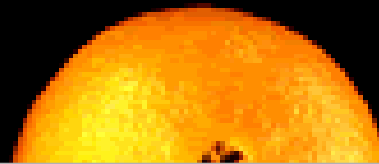

1

PLANTA TECHOS

B

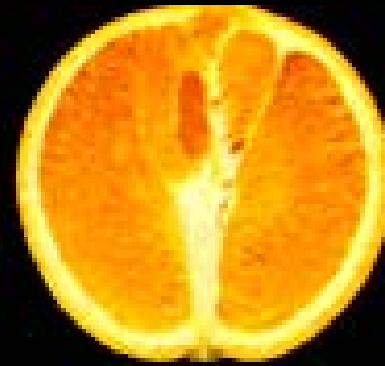

LT

CORTE 1

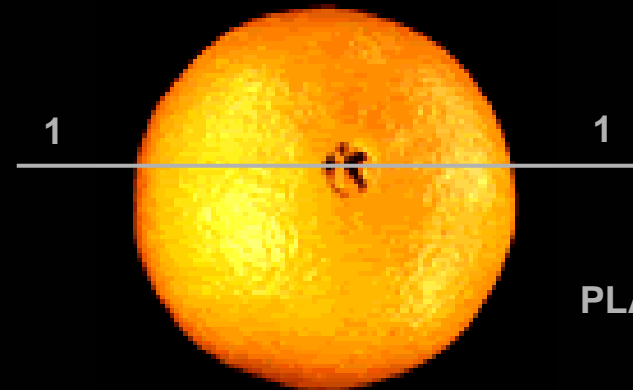

PLANTA TECHOS

LT



FACHADA

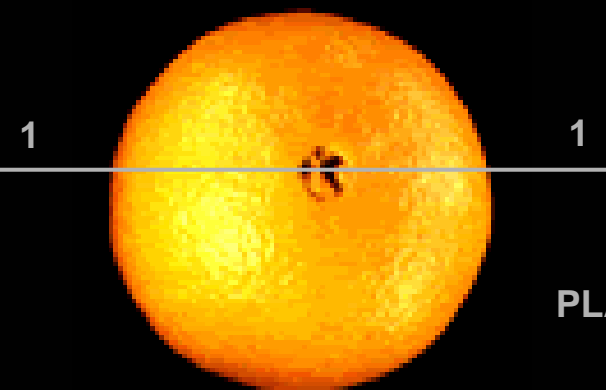

PLANTA TECHOS

LT



SAIBADA

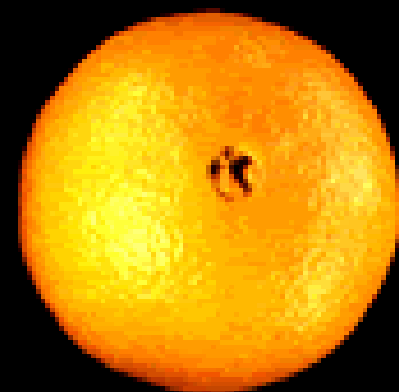

PLANTA TECHOS

1

1

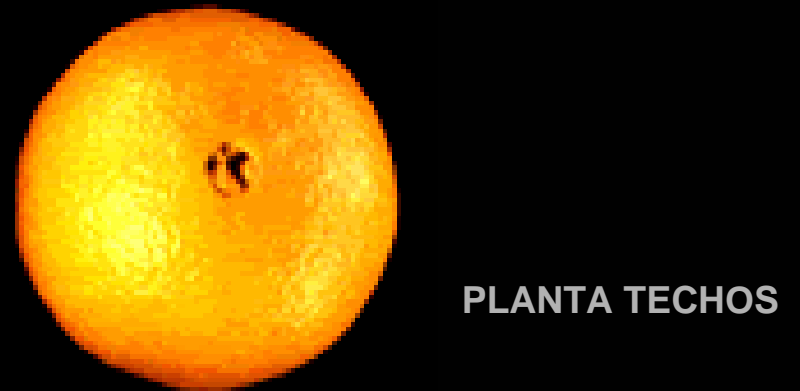
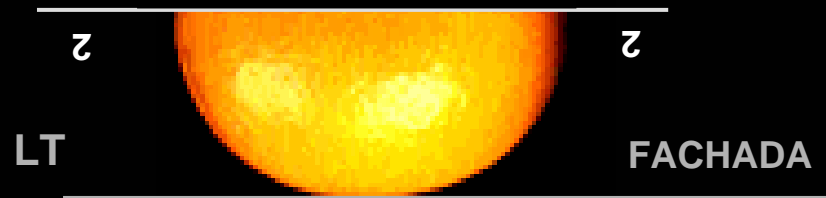
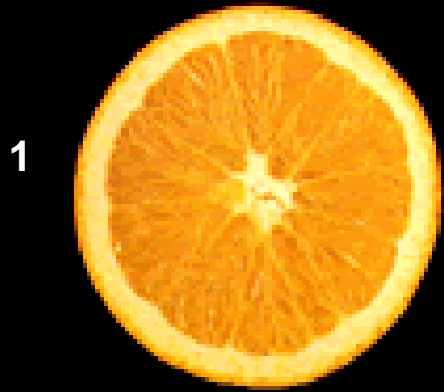

LT

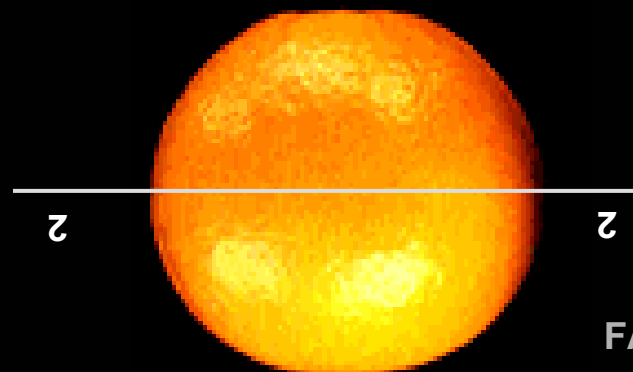

FACHADA

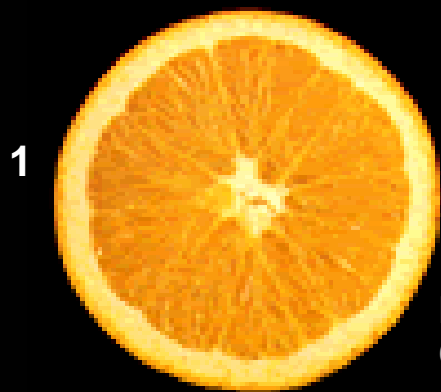

PLANTA  
CORTE 2

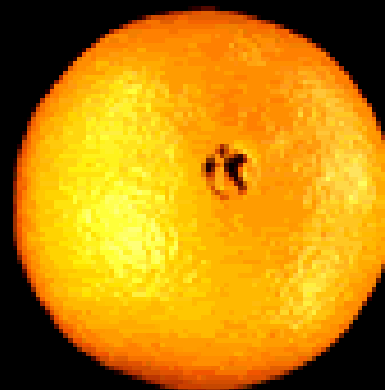

PLANTA TECHOS

LT

2

2

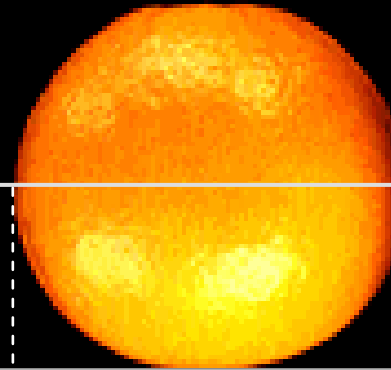

FACHADA

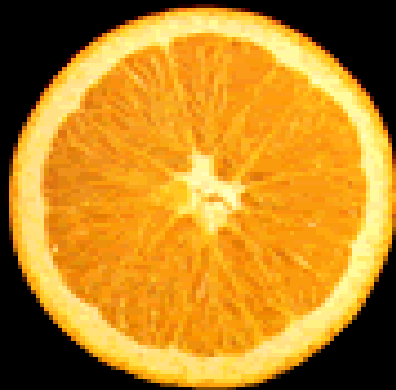

PLANTA  
CORTE 2

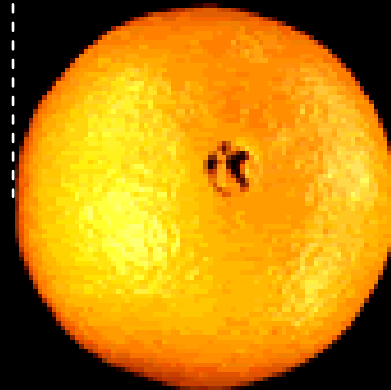

PLANTA  
TECHOS



proyección

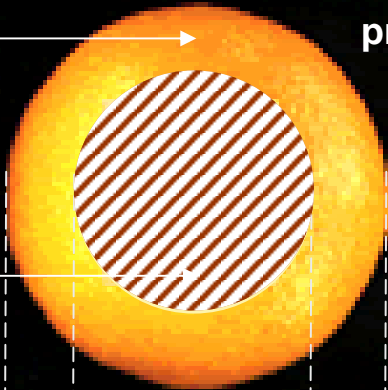

proyección

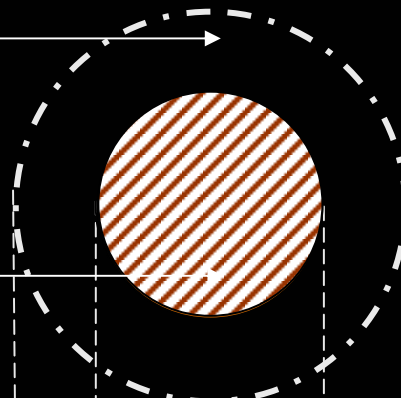

sección

sección

CORTE 1

CORTE 3

LT

1

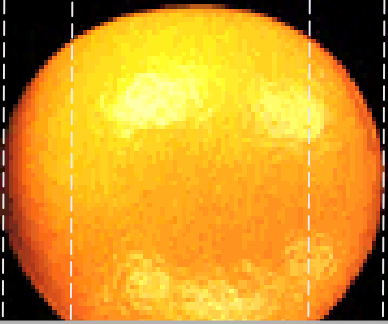

1

3



3

PLANTA TECHOS

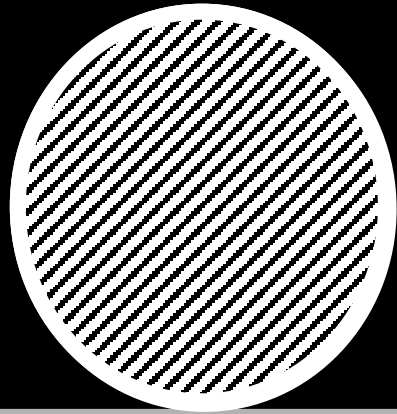

LT

CORTE 1

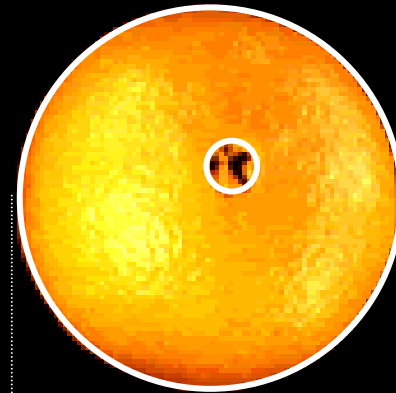

FACHADA

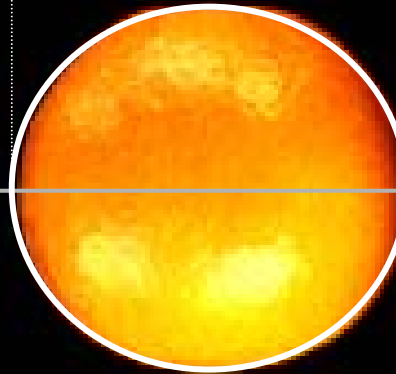

1

1

PLANTA TECHOS

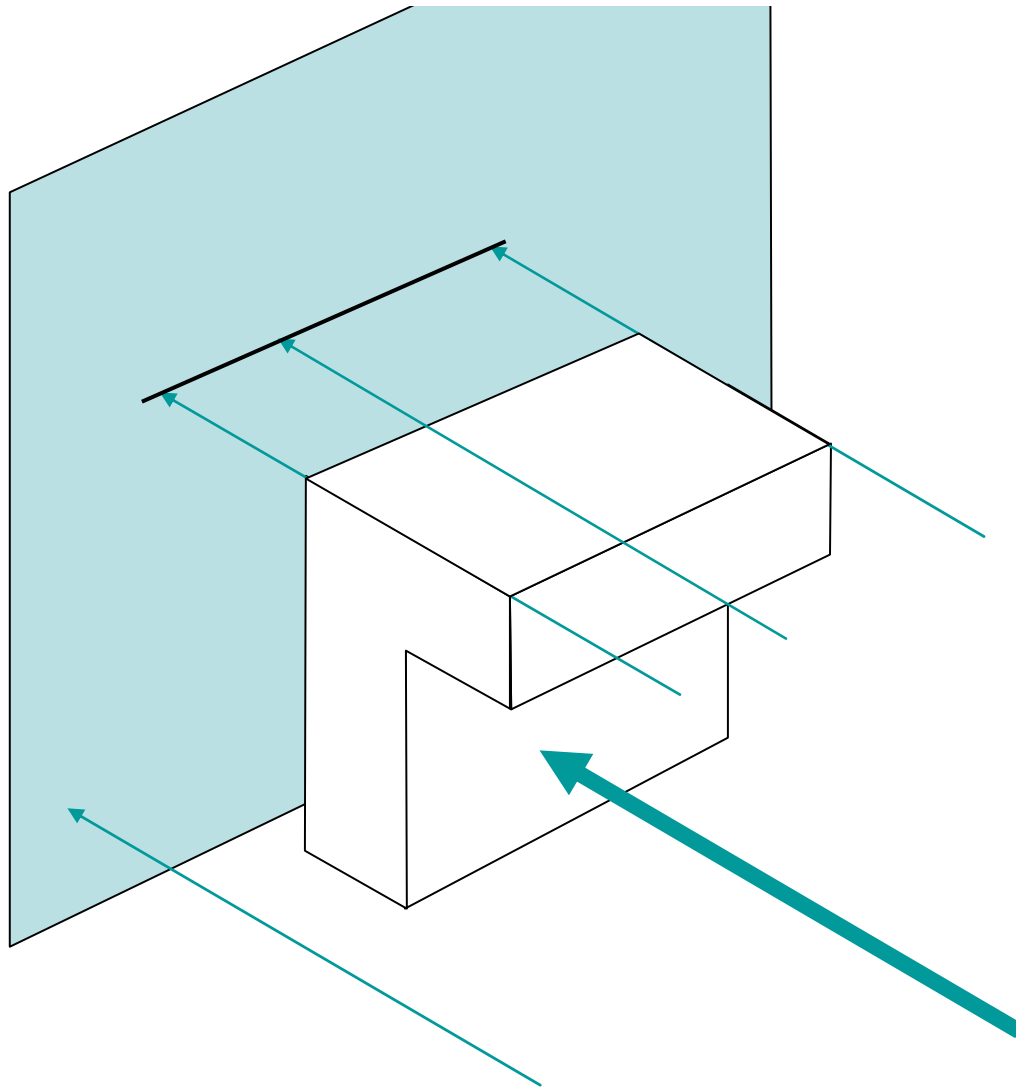

**PROYECCIONES PARALELAS  
O CILÍNDRICAS**

**PROYECCIONES  
ORTOGONALES**

proyectantes  
perpendiculares al plano  
de representación...

cualquiera sea la  
ubicación del objeto

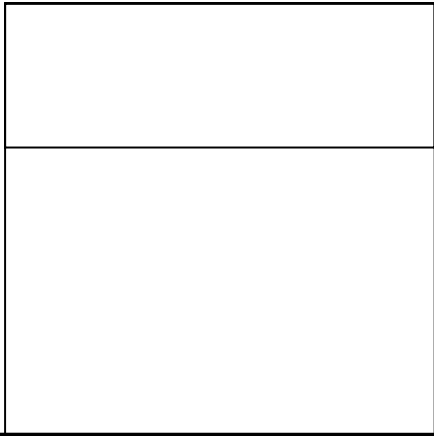

LT

FACHADA

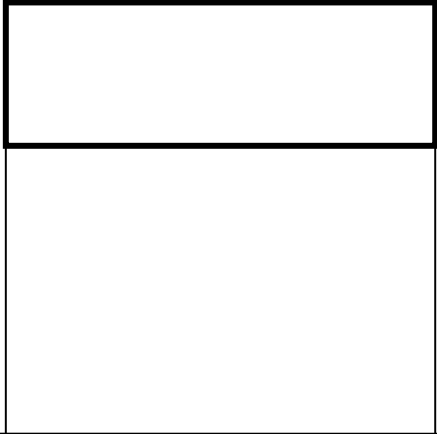

LT

FACHADA + TRAZO VALORADO

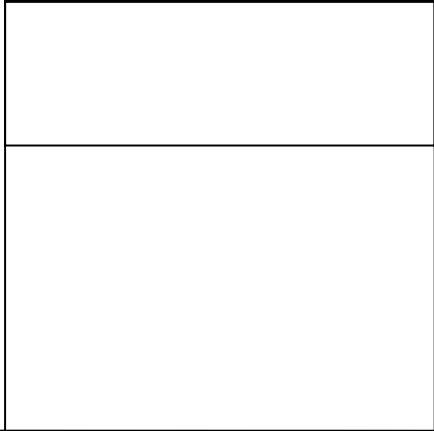

LT

FACHADA + PLANTA TECHOS

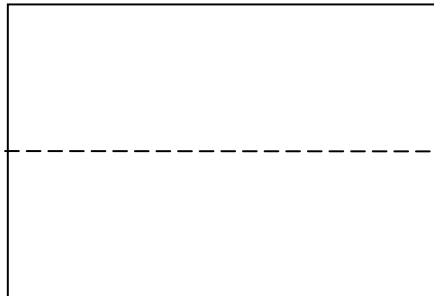

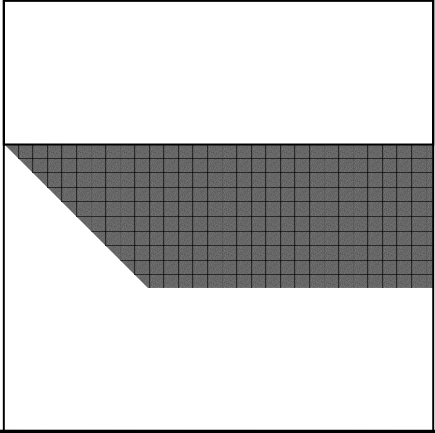

LT

FACHADA + SOMBRA

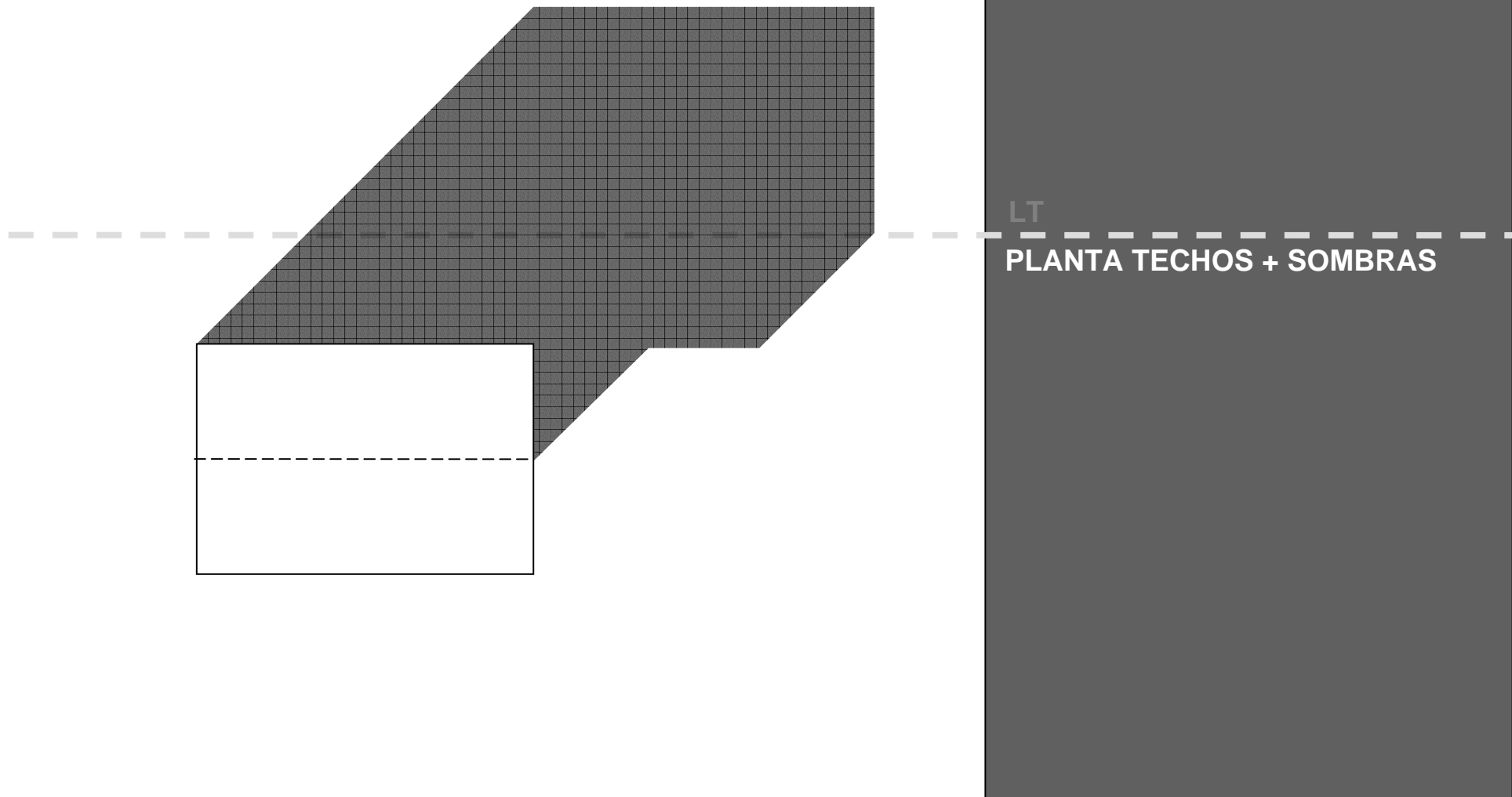

LT

**PLANTA TECHOS + SOMBRAS**



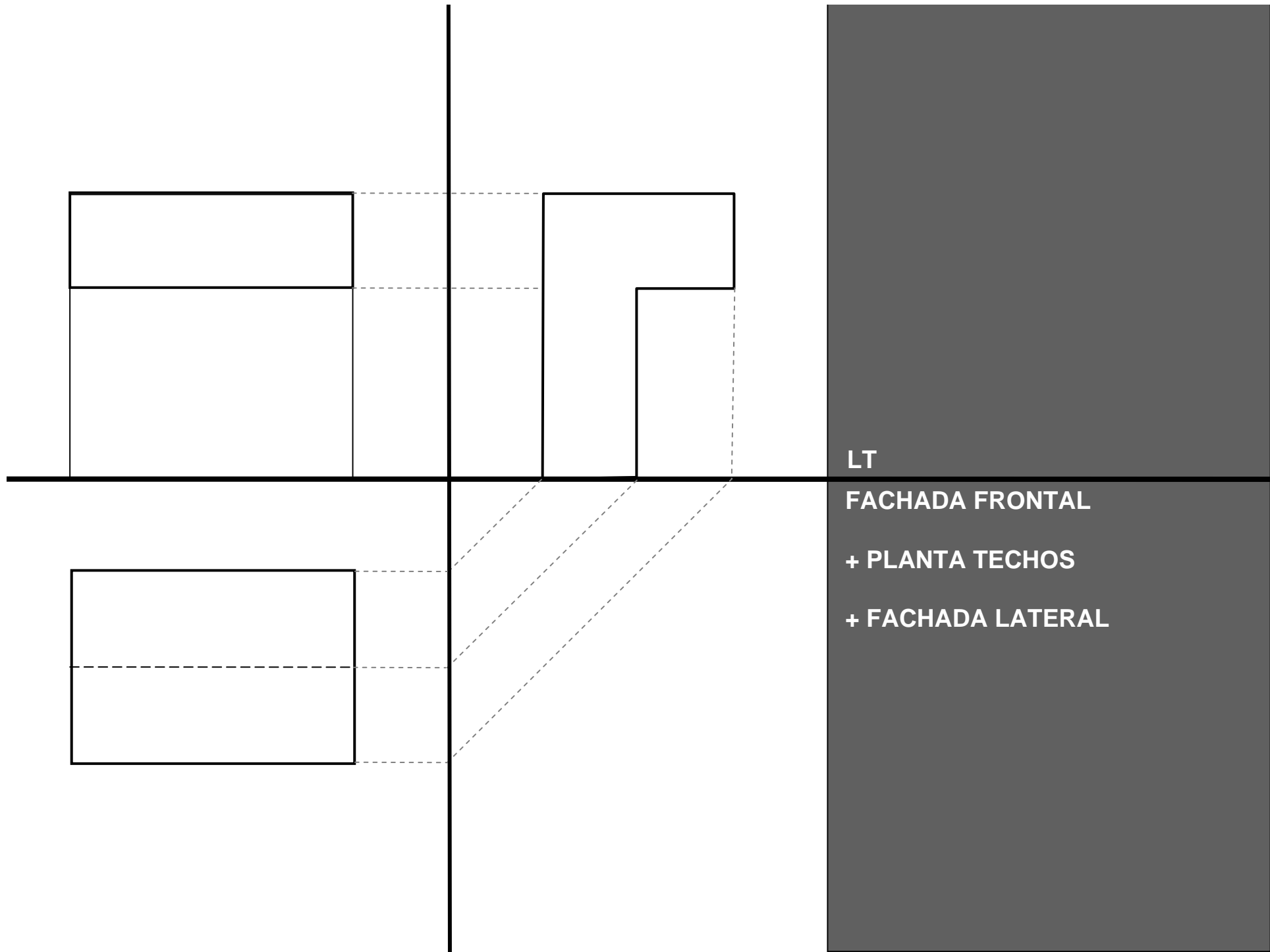

LT

FACHADA FRONTAL

+ PLANTA TECHOS

+ FACHADA LATERAL

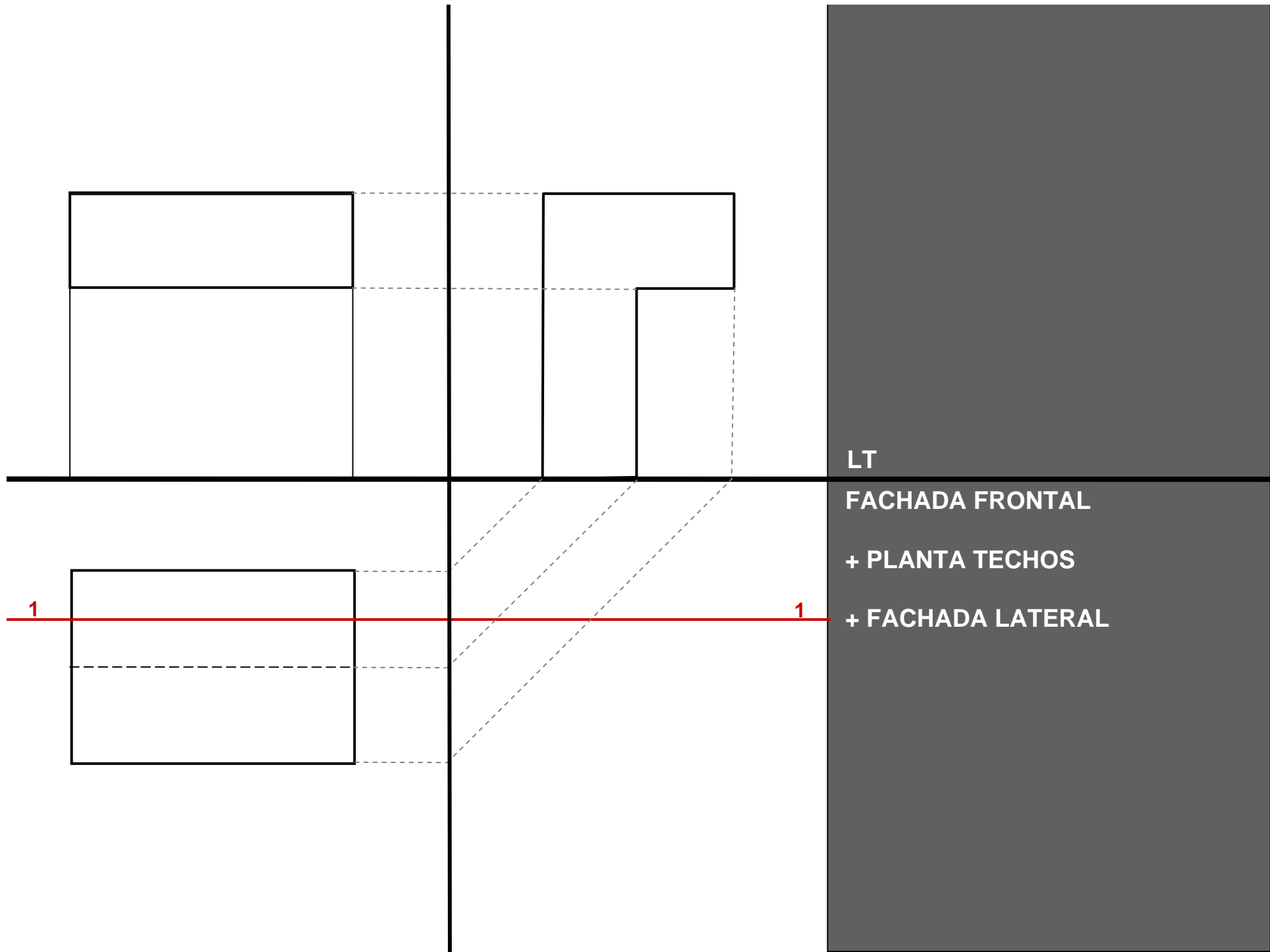

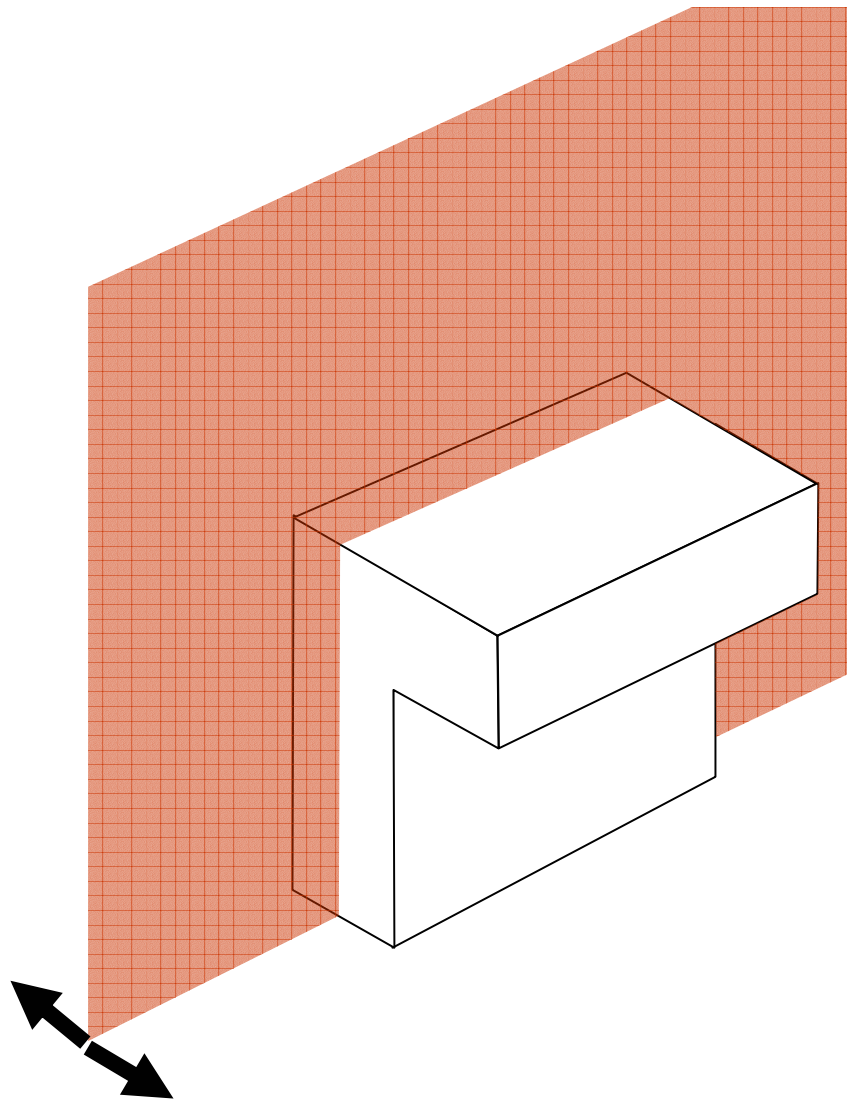

**CORTE CON PLANO VERTICAL**

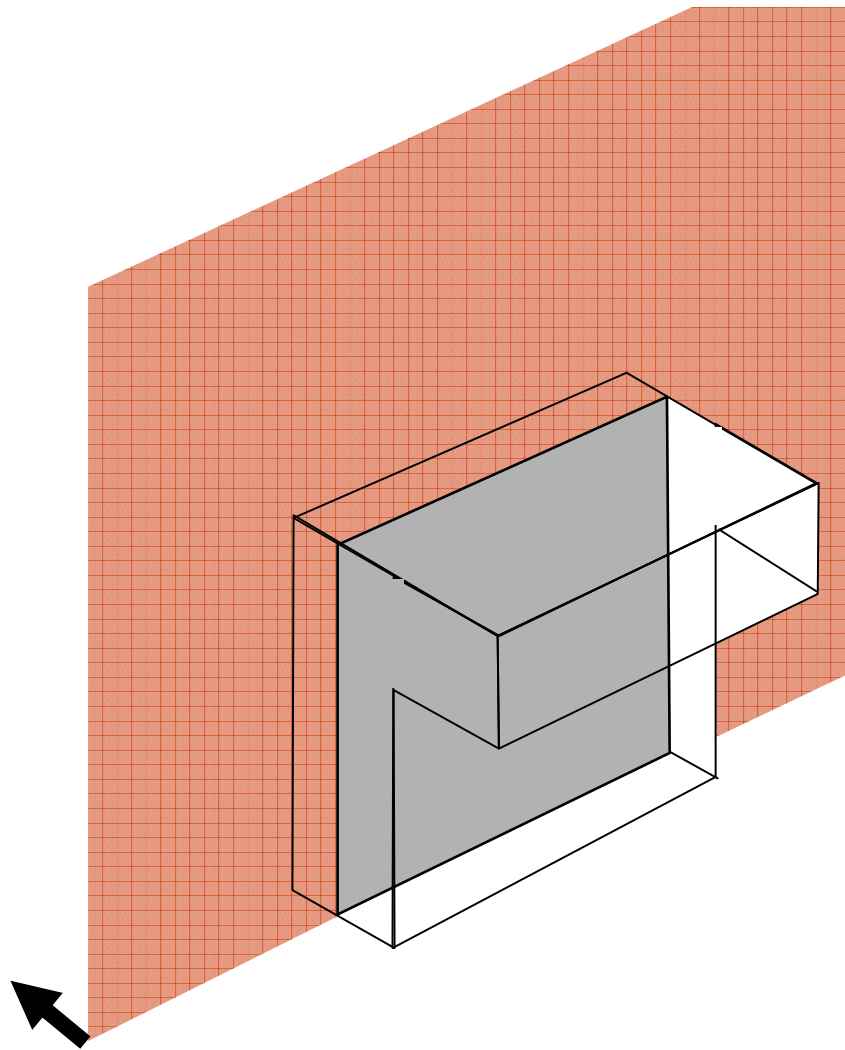

CORTE CON PLANO VERTICAL

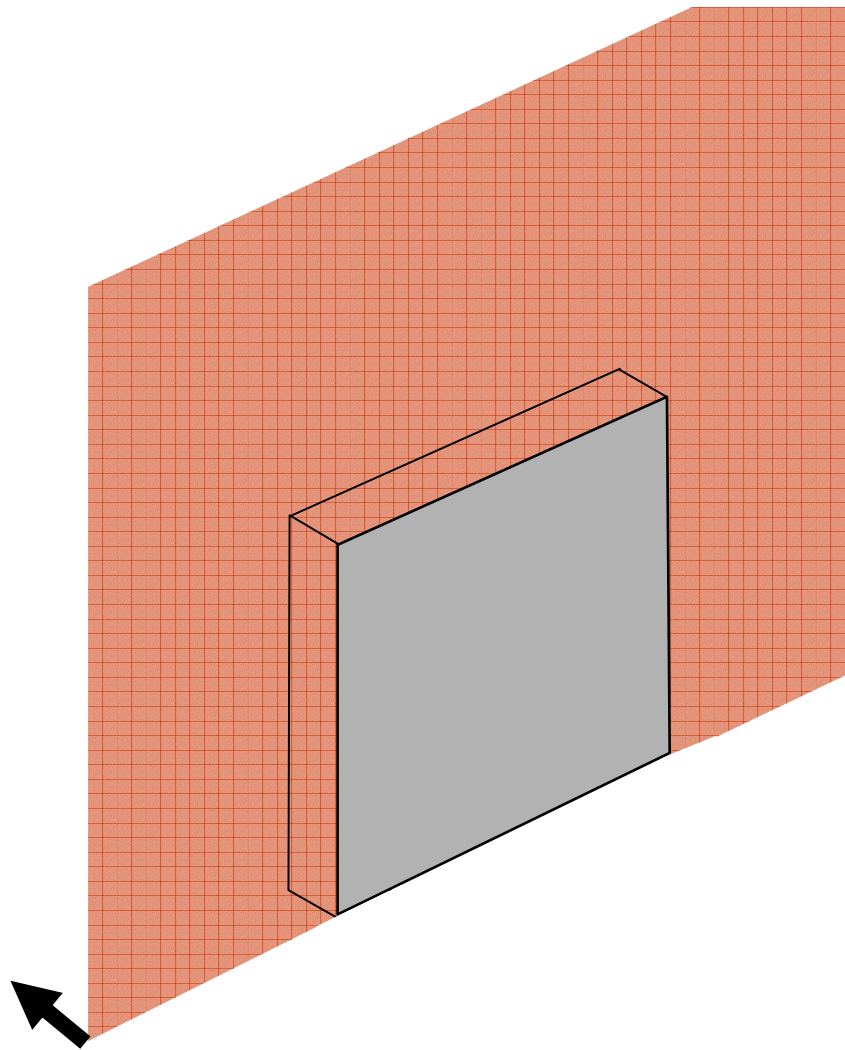

**CORTE CON PLANO VERTICAL**



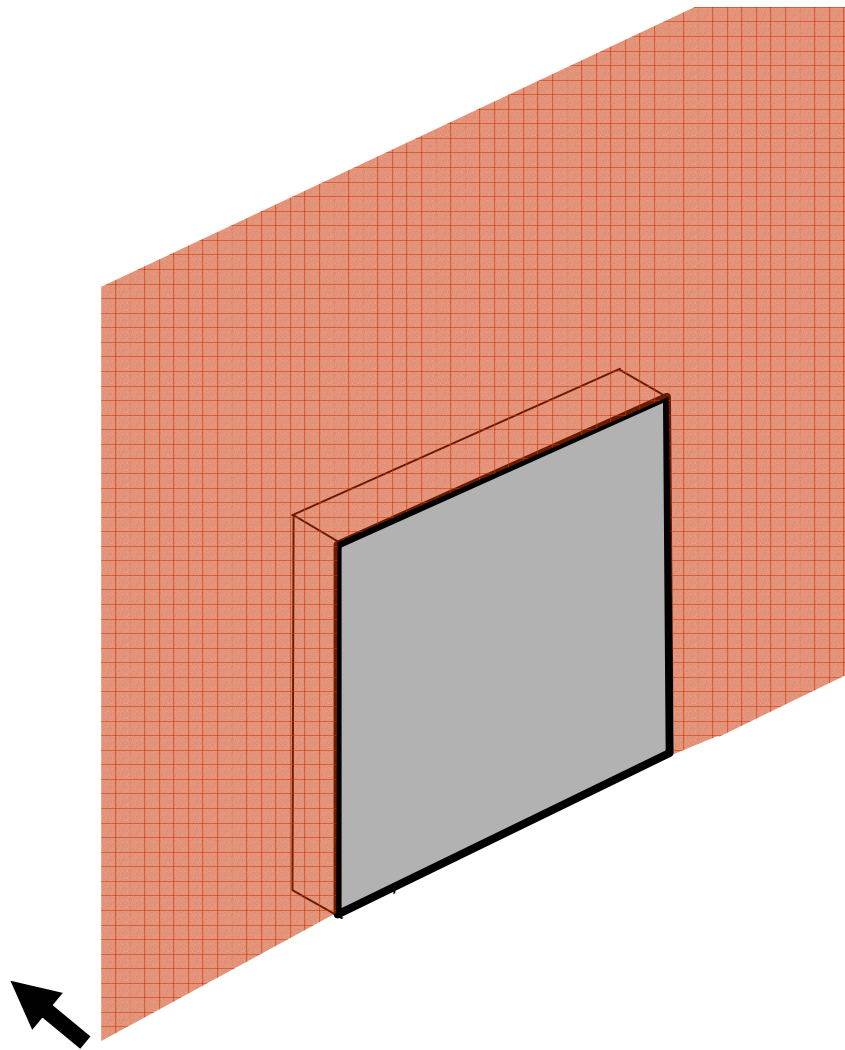

CORTE CON PLANO VERTICAL



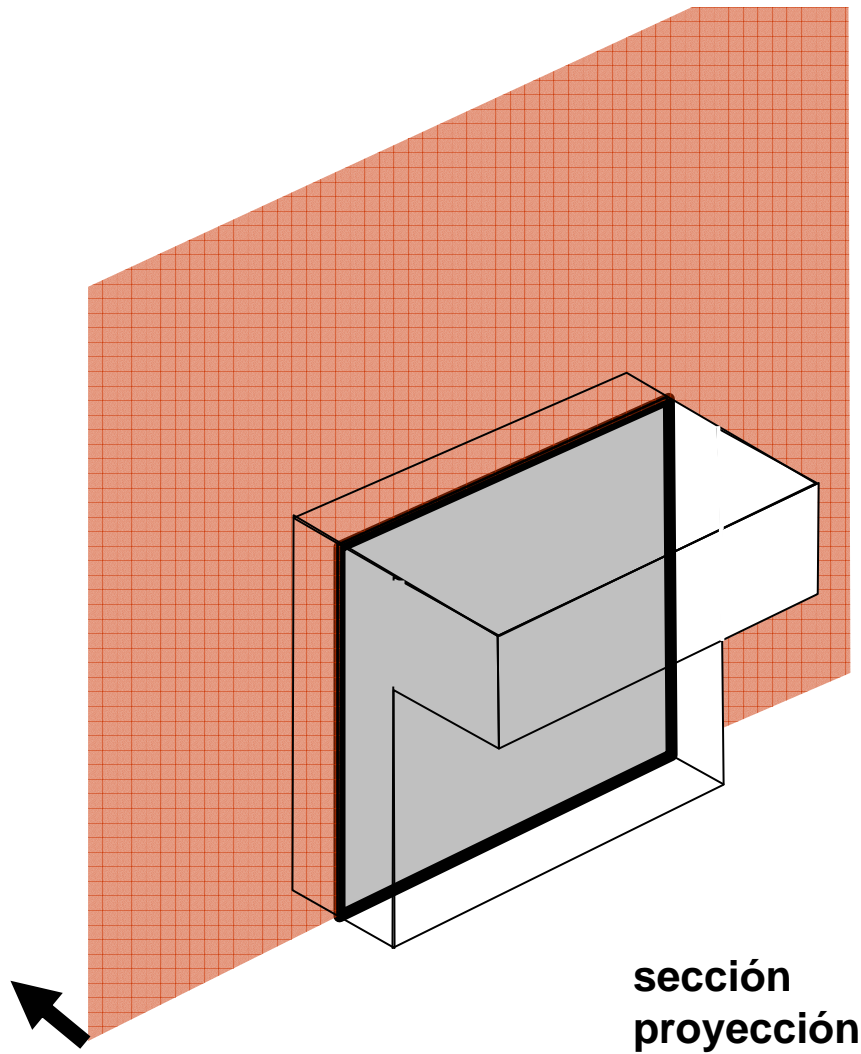

CORTE CON PLANO VERTICAL

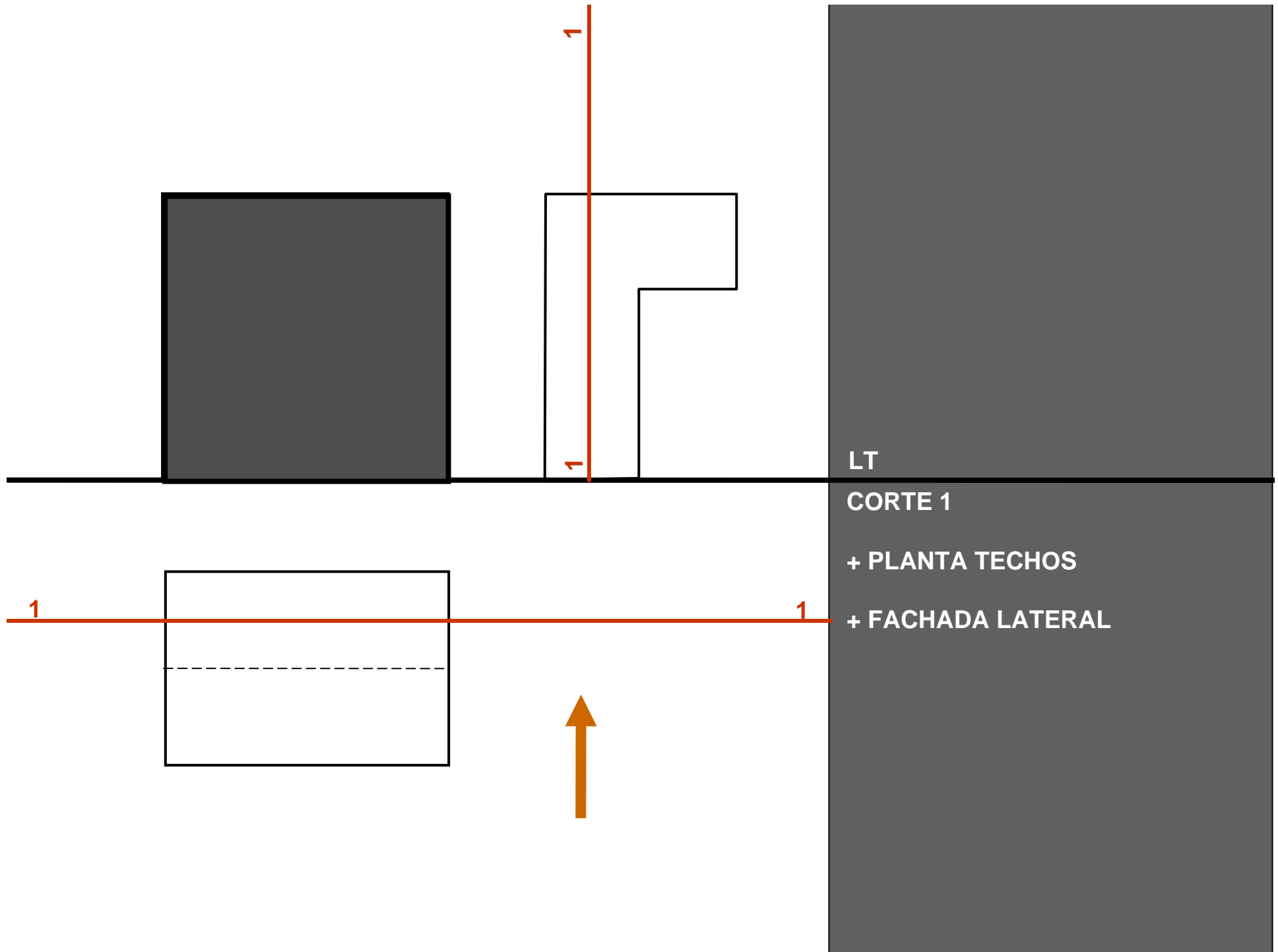



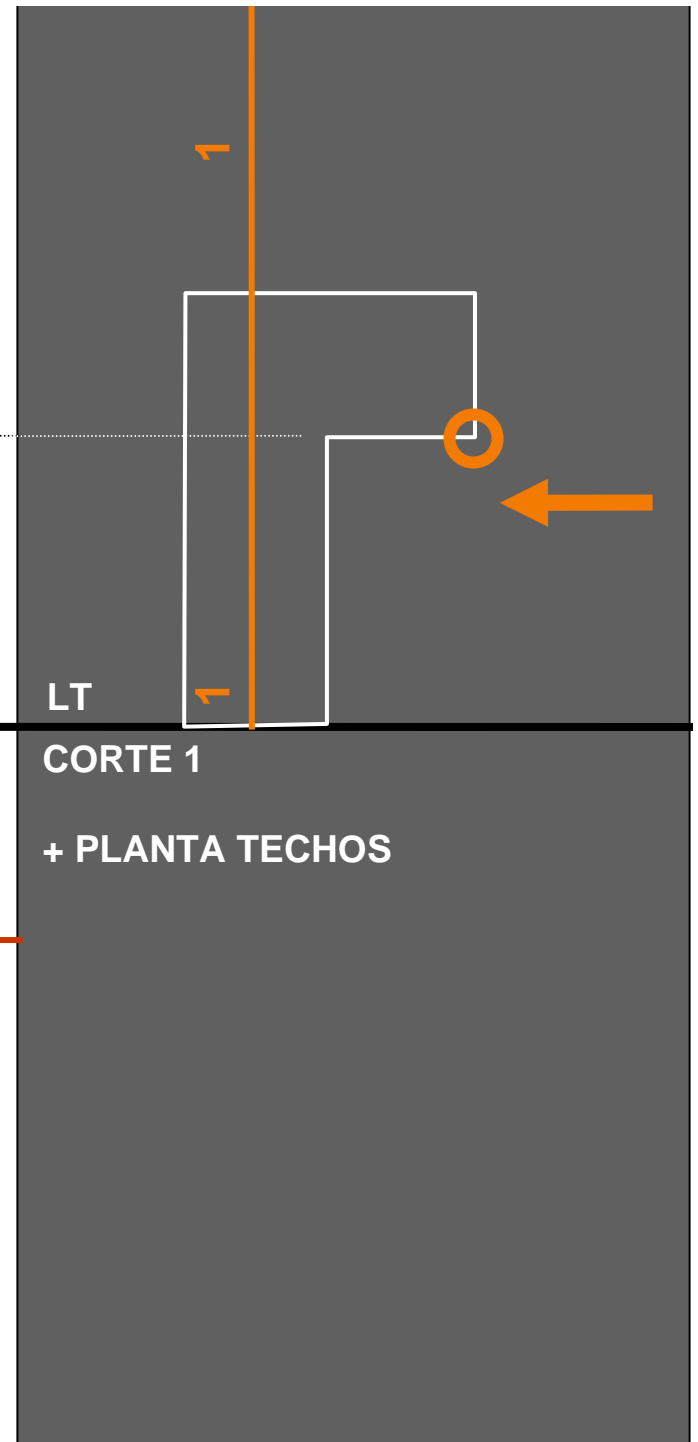
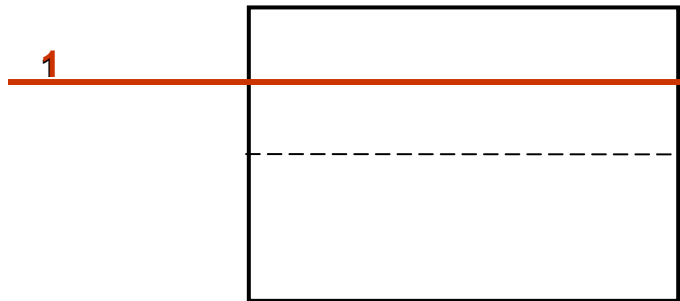
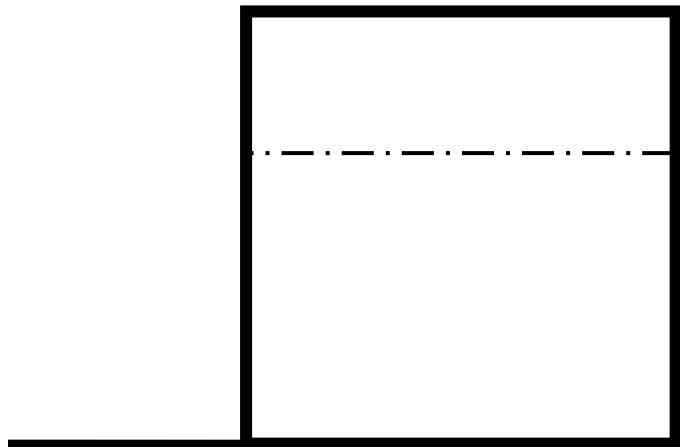

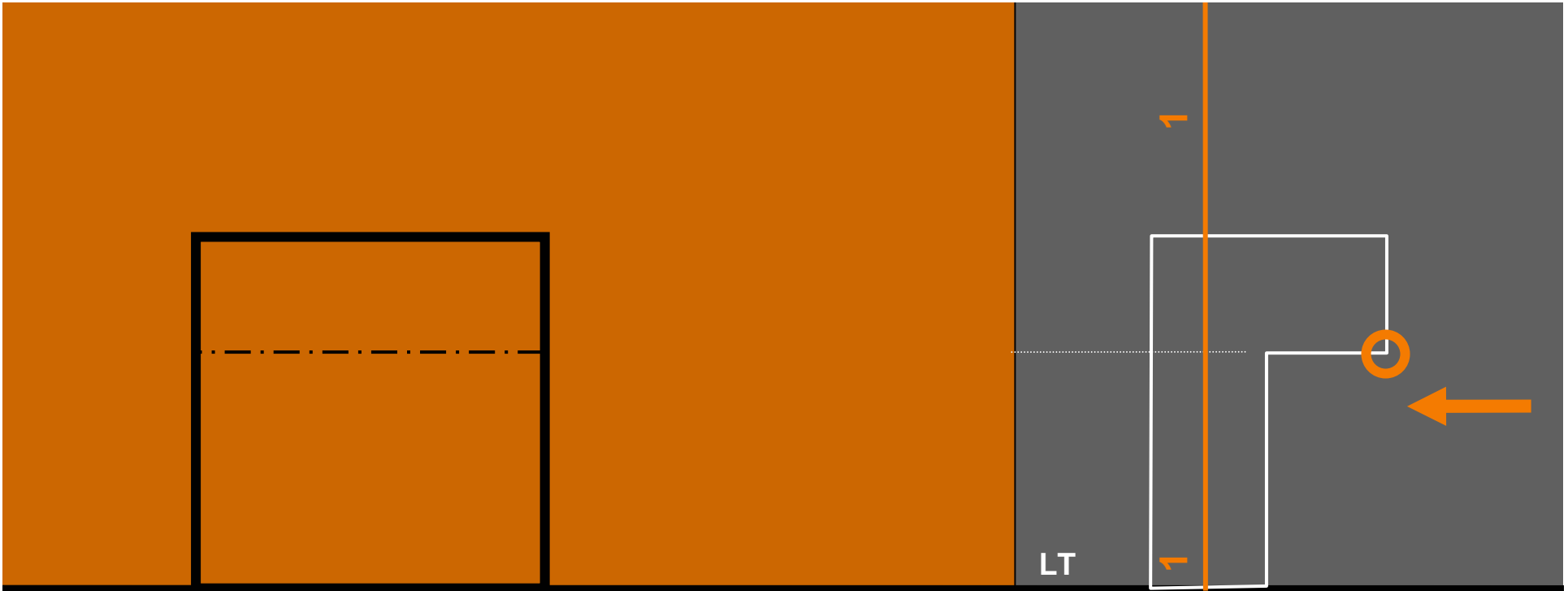

LT

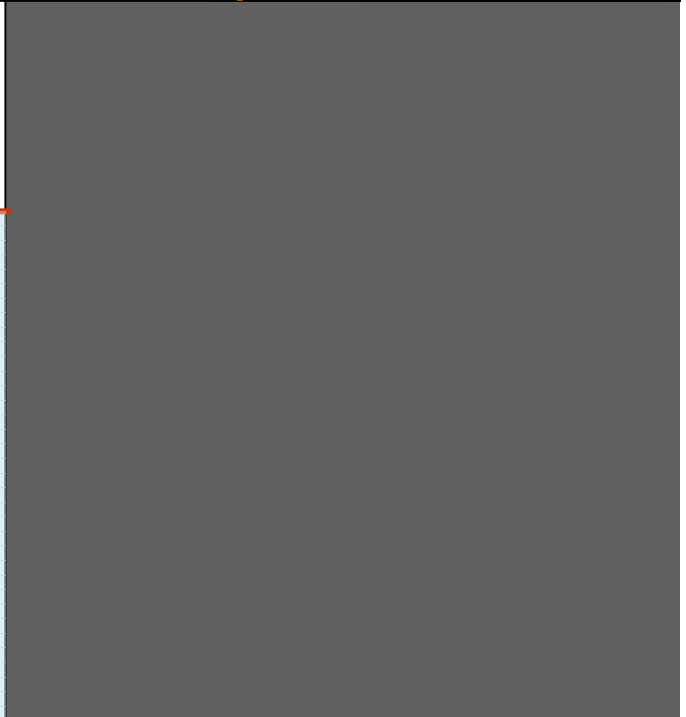
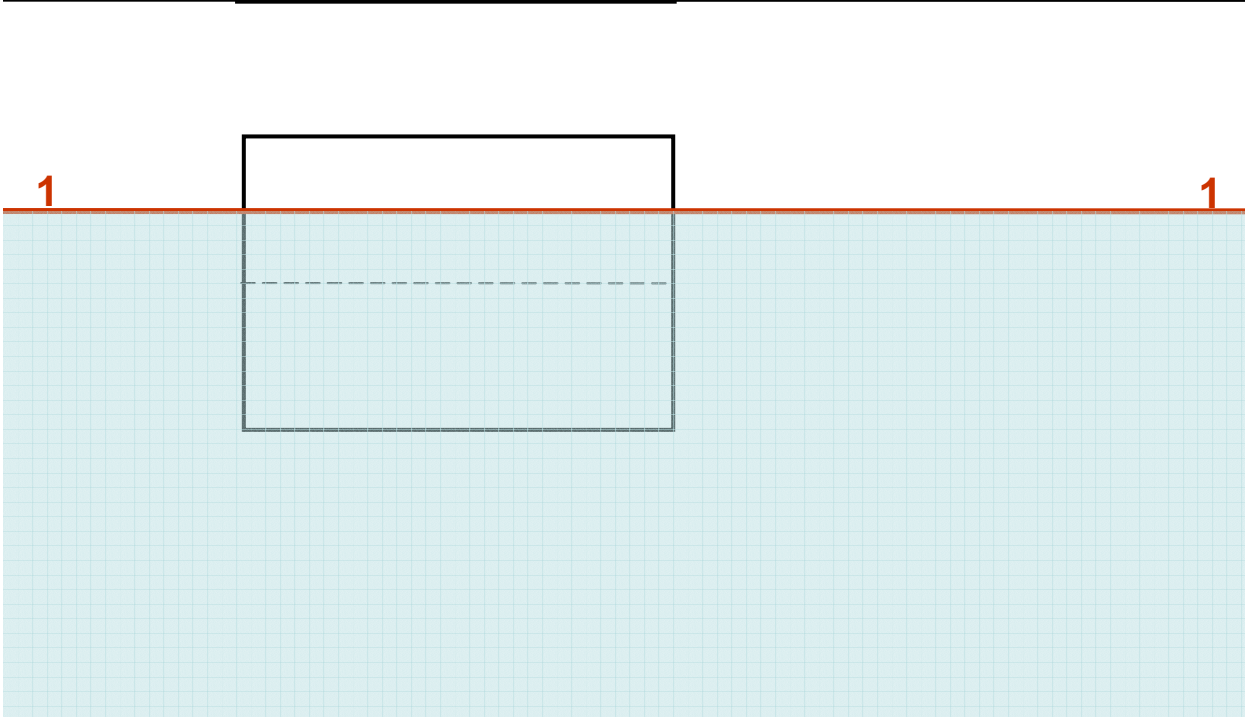
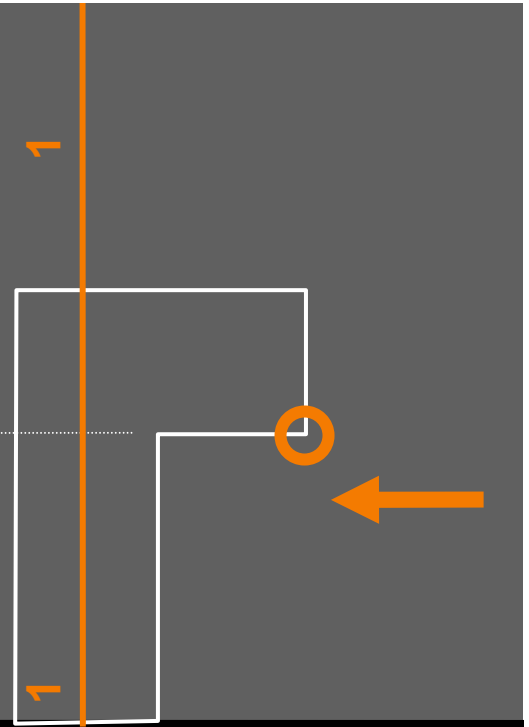

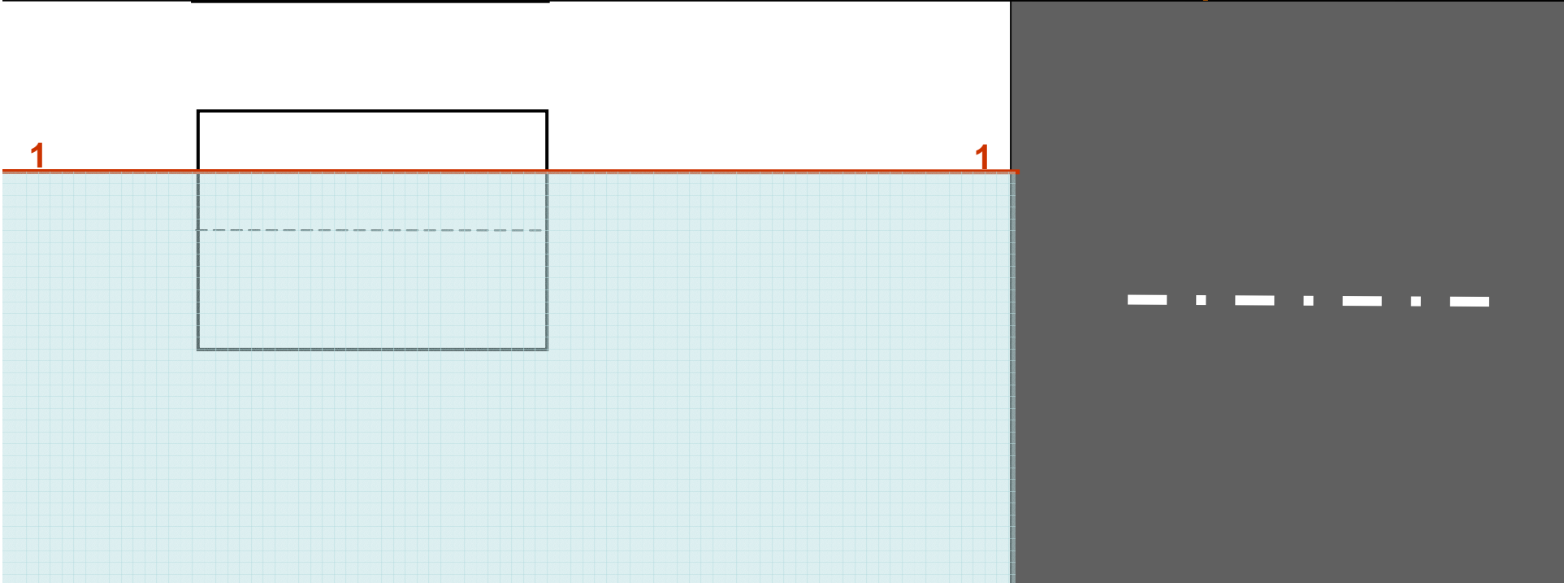
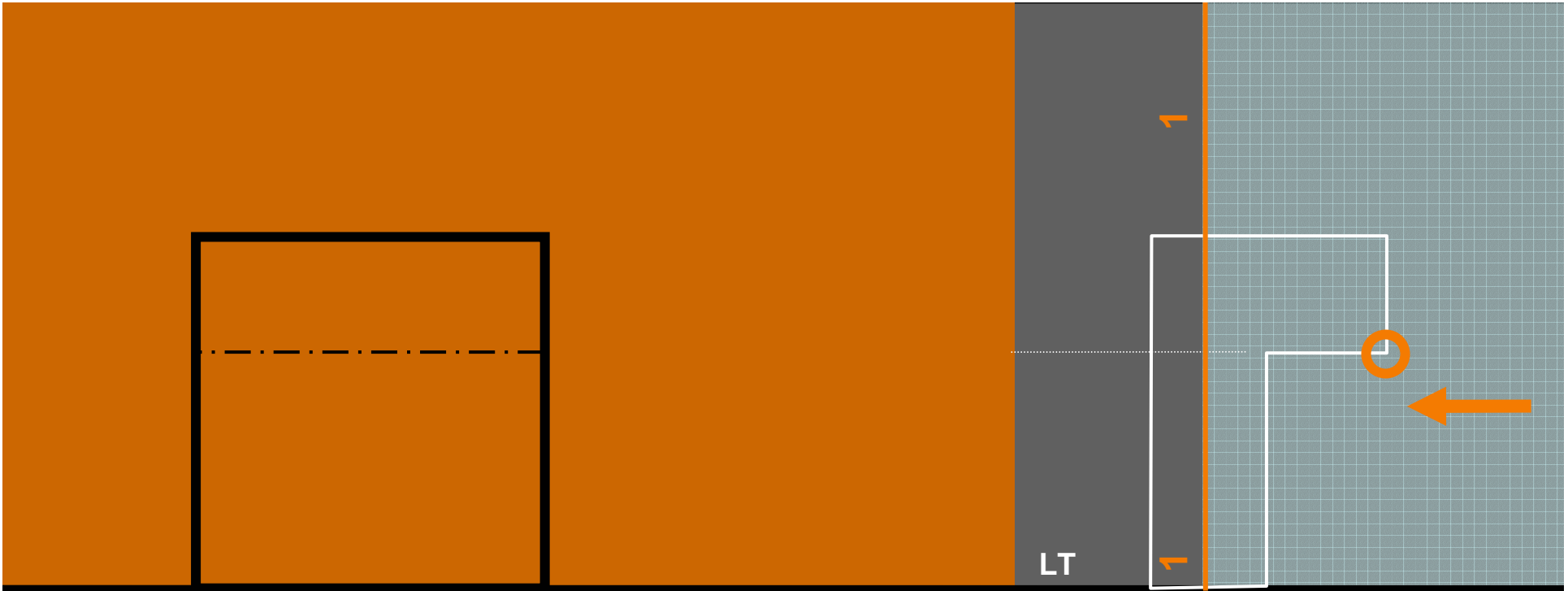

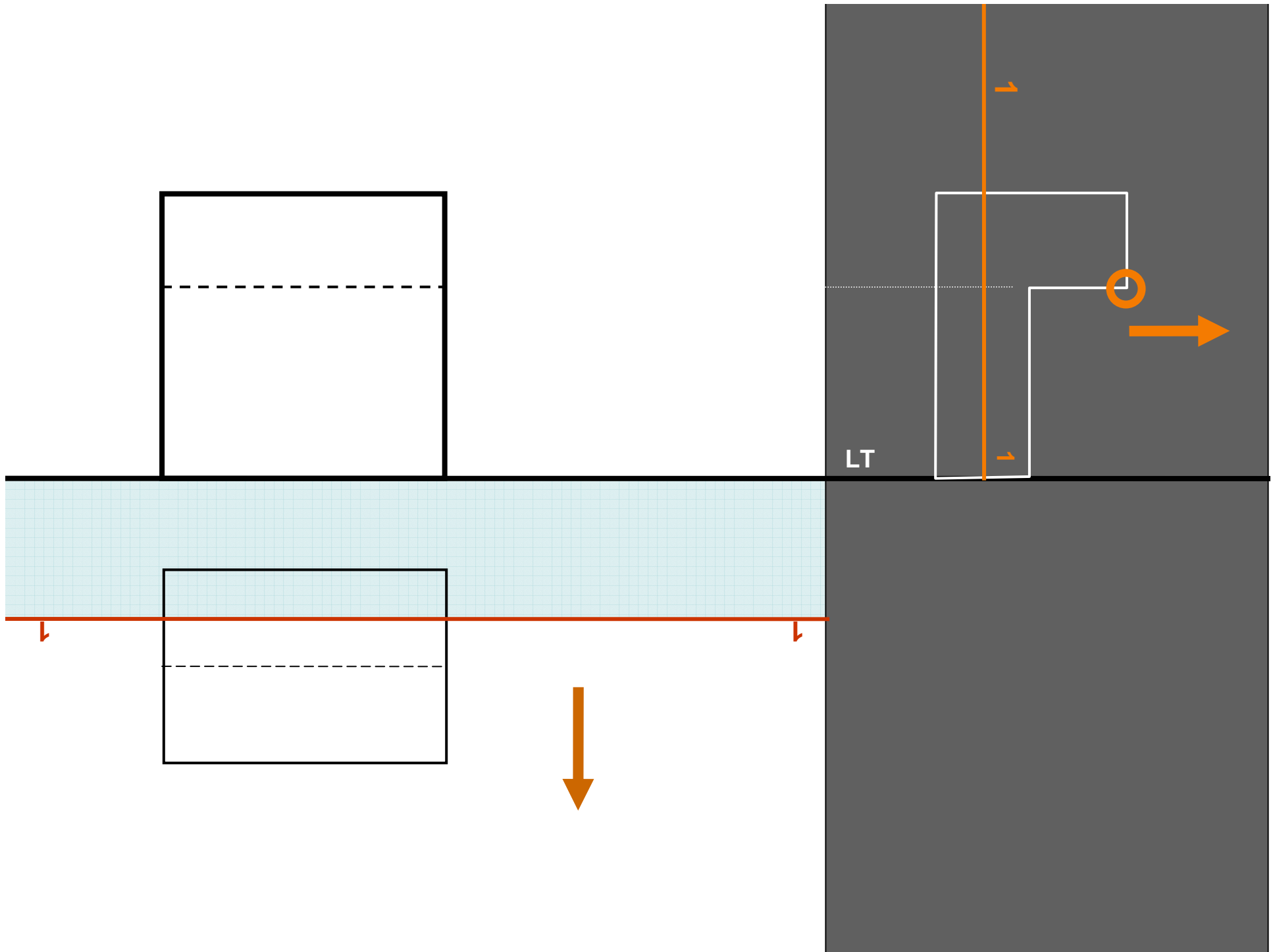

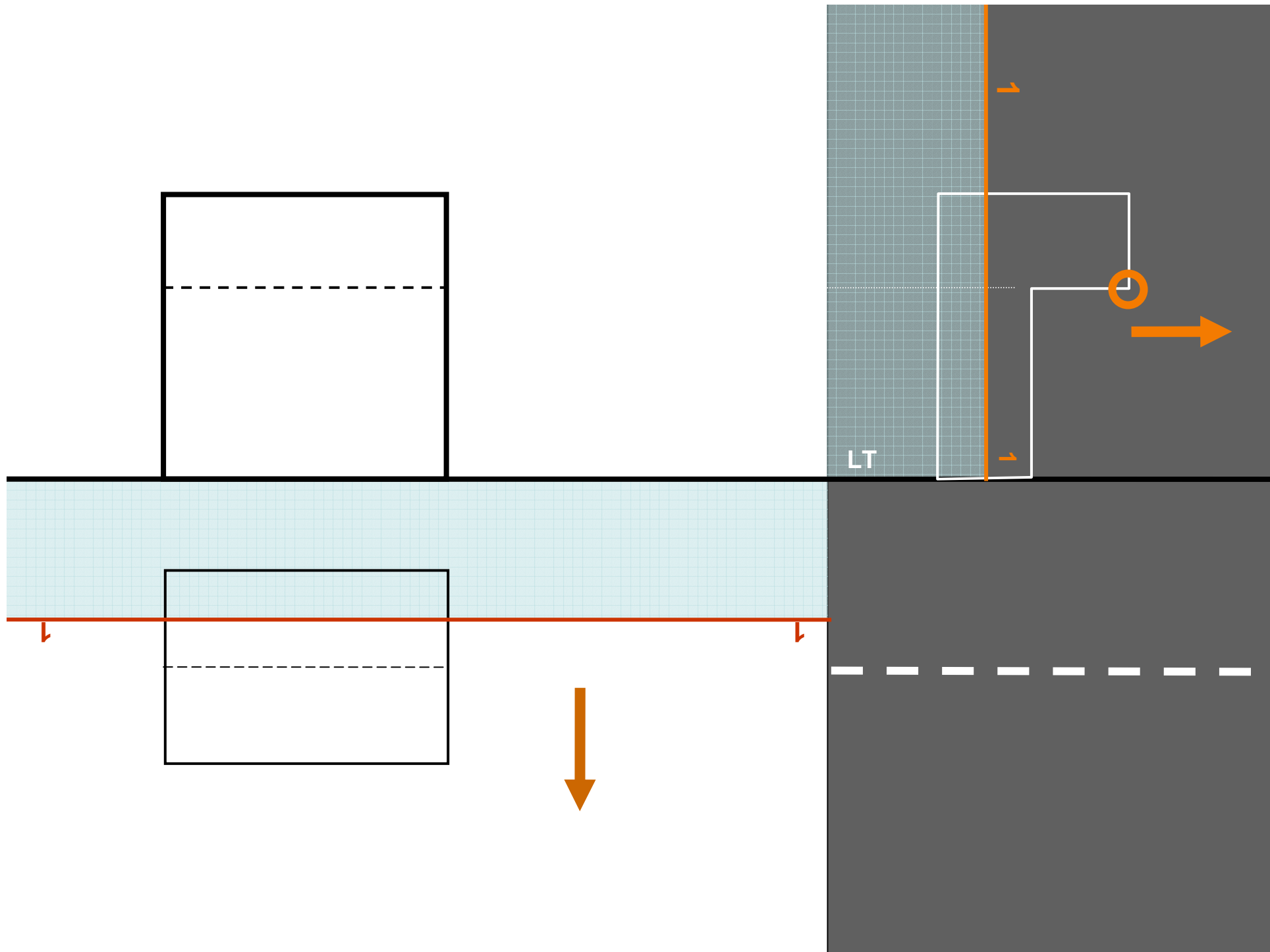

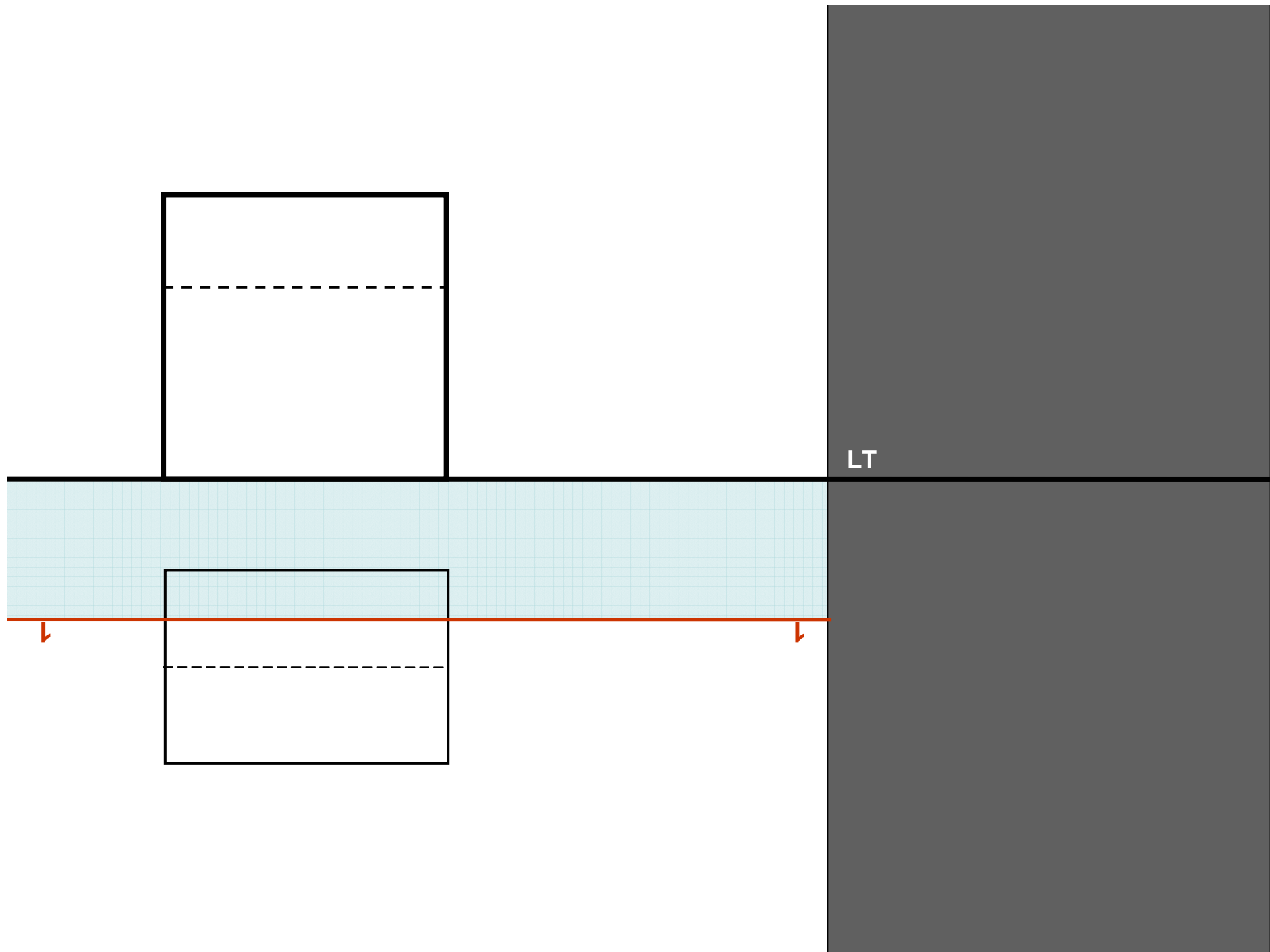

LT

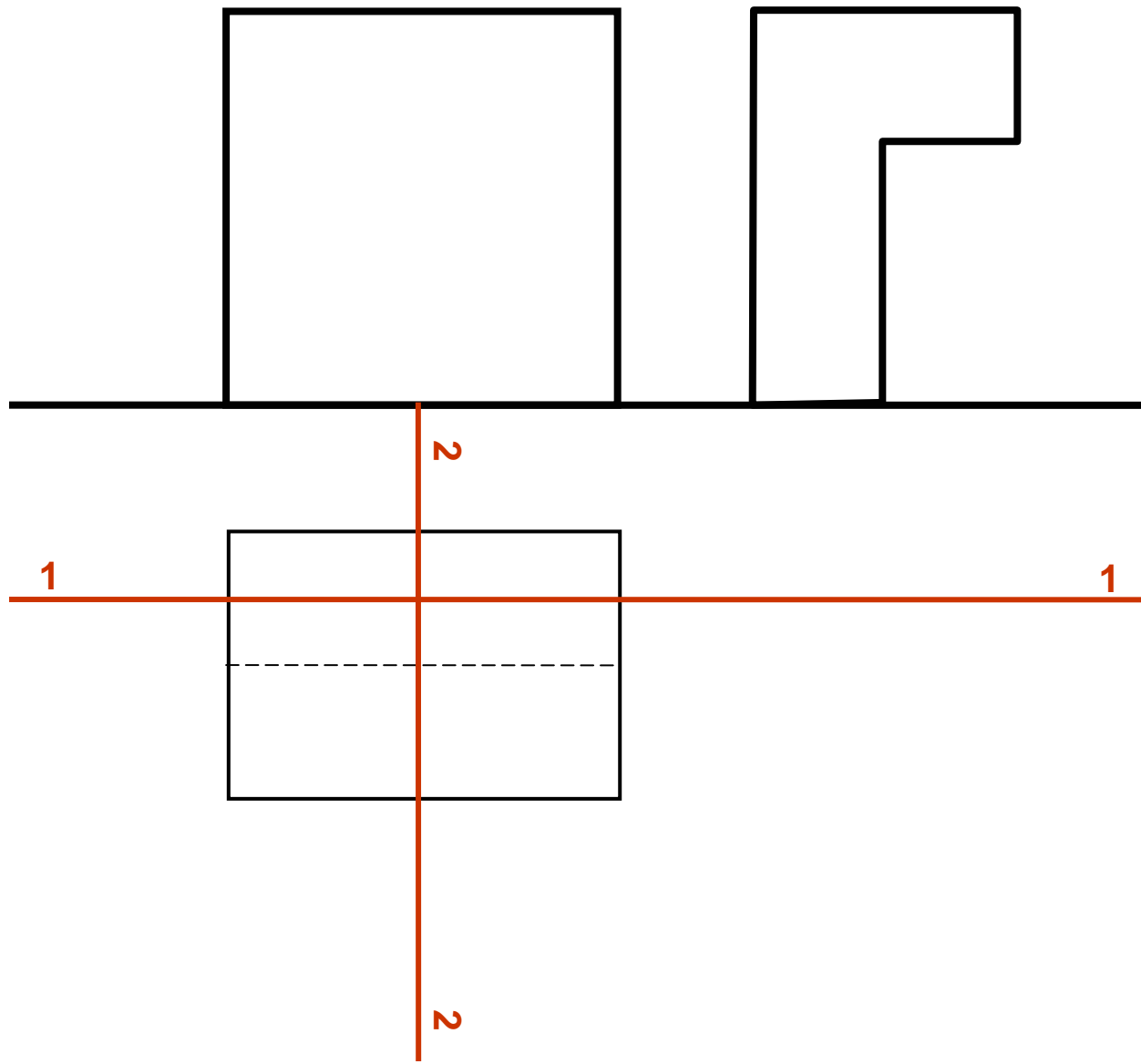

LT

CORTE 1 + CORTE 2

+ PLANTA TECHOS

+ FACHADA LATERAL

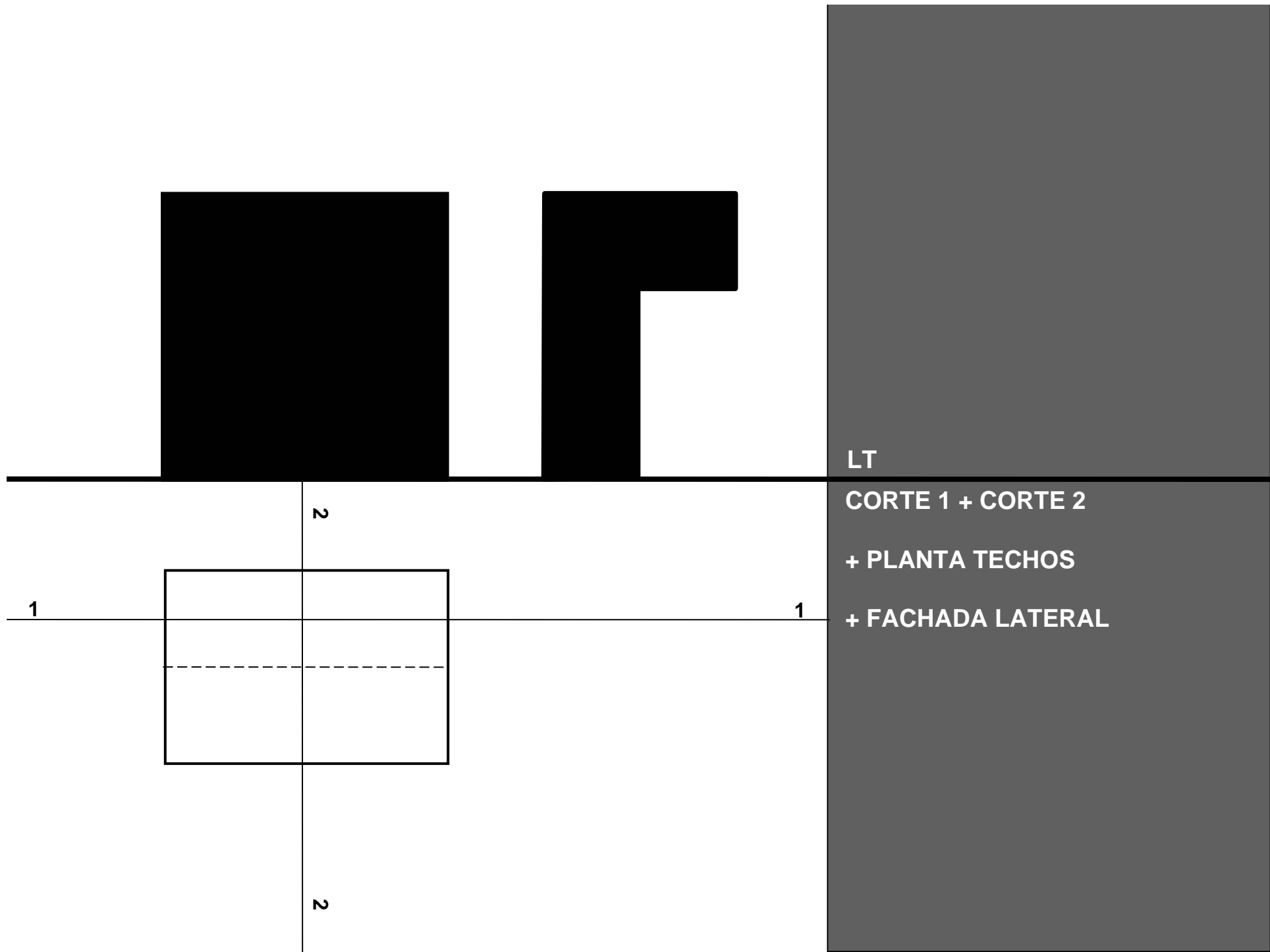



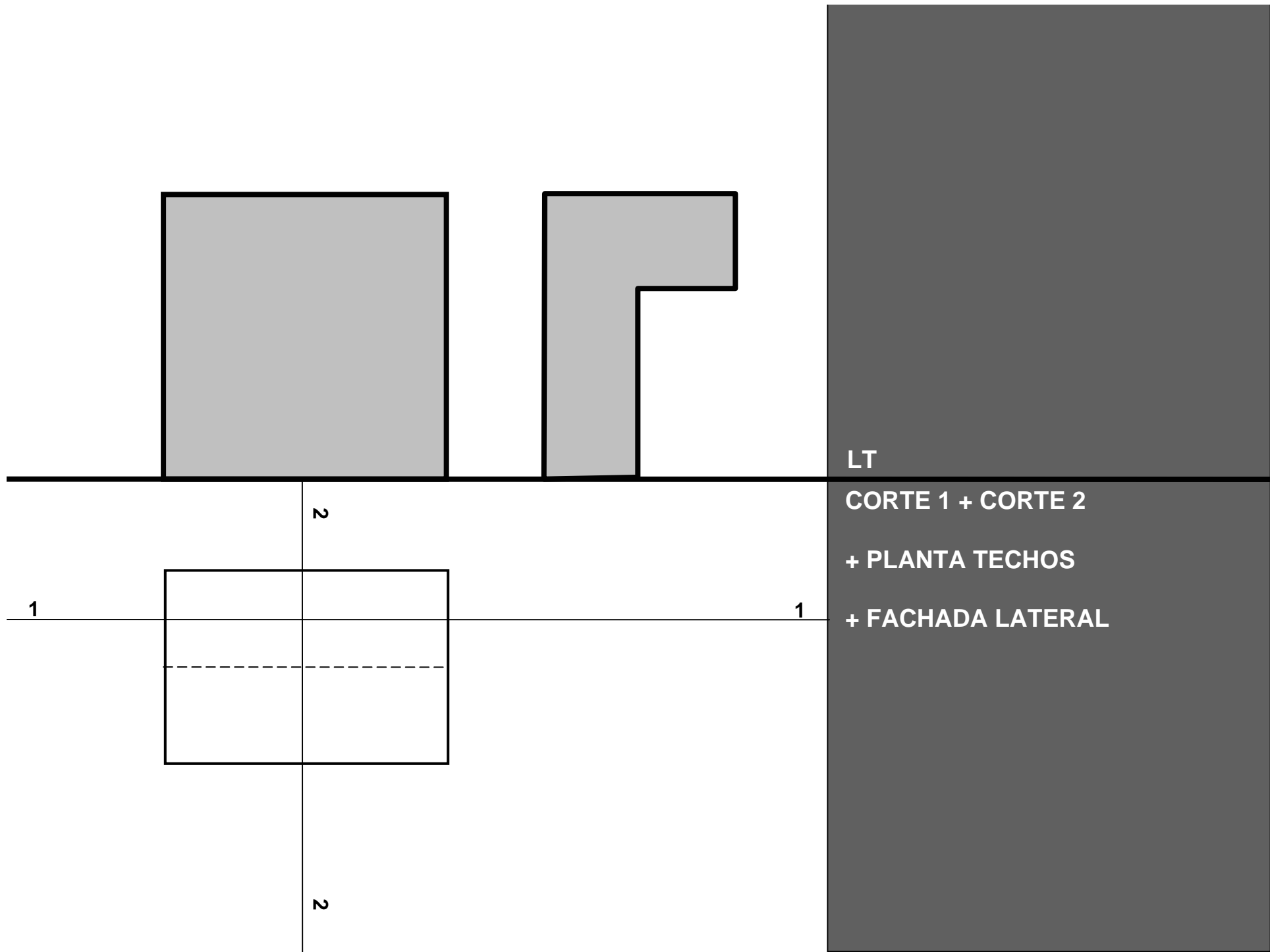

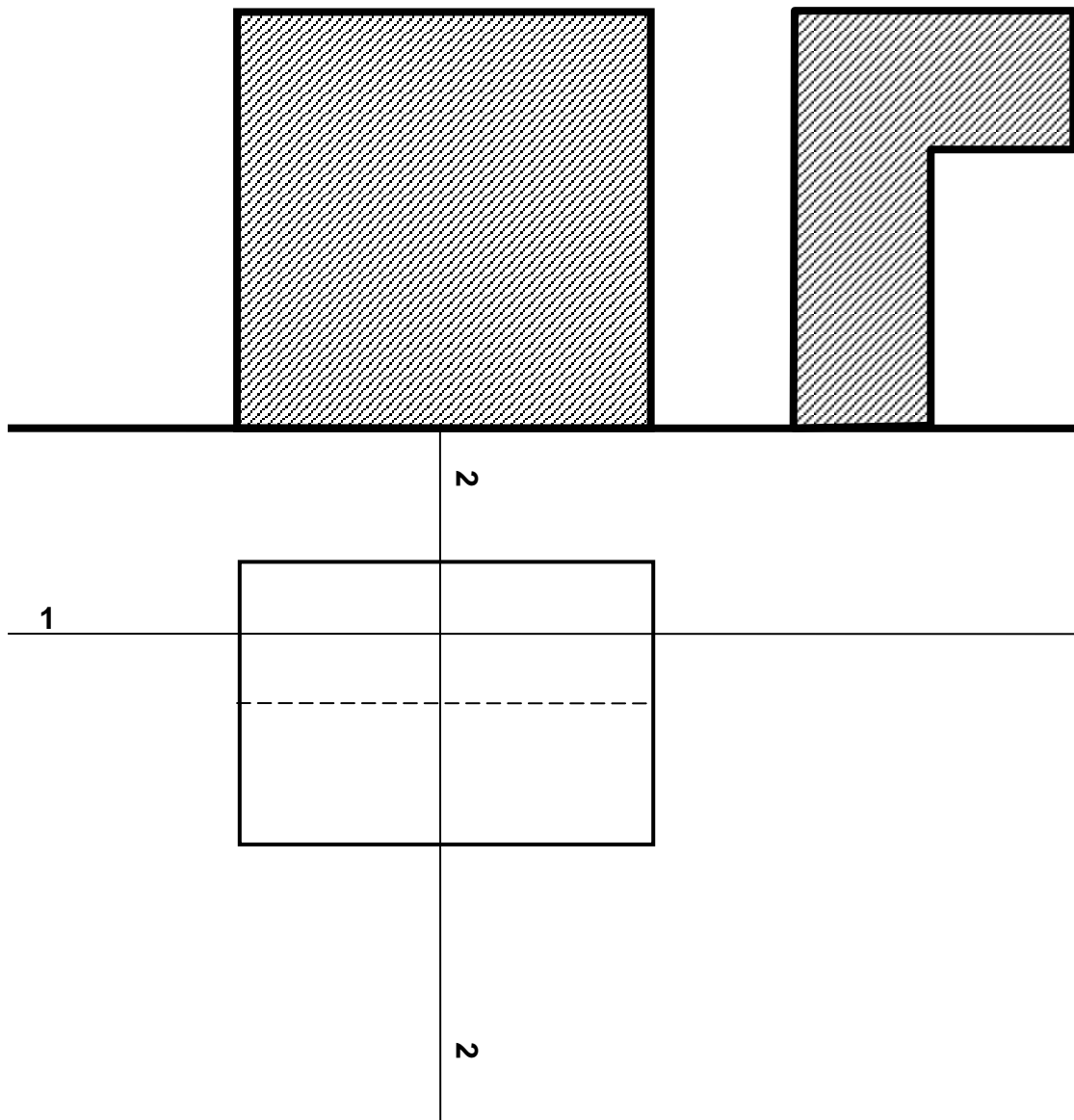

LT

CORTE 1 + CORTE 2

+ PLANTA TECHOS

+ FACHADA LATERAL

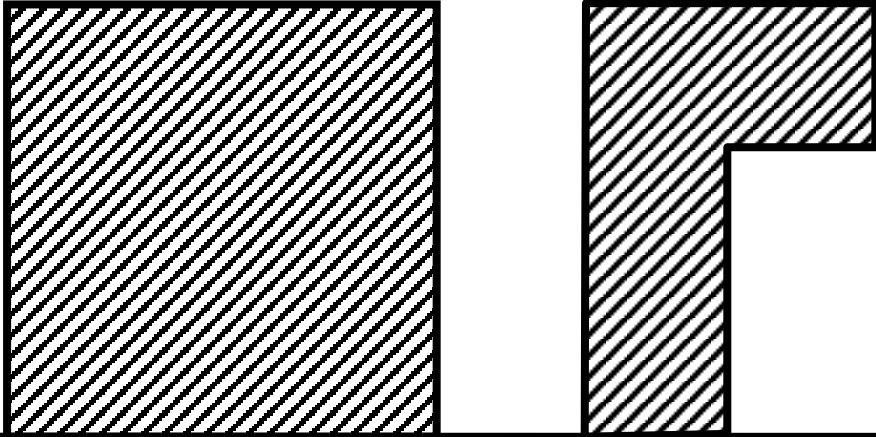

LT

CORTE 1 + CORTE 2

+ PLANTA TECHOS

+ FACHADA LATERAL

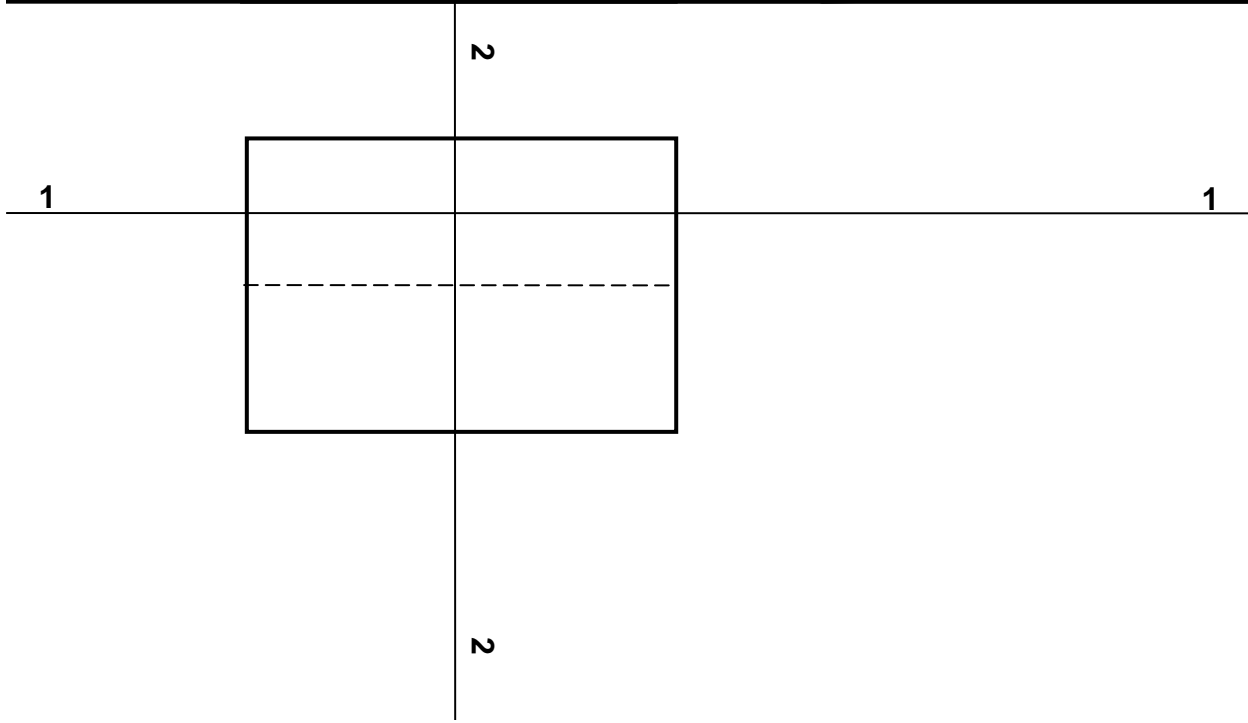

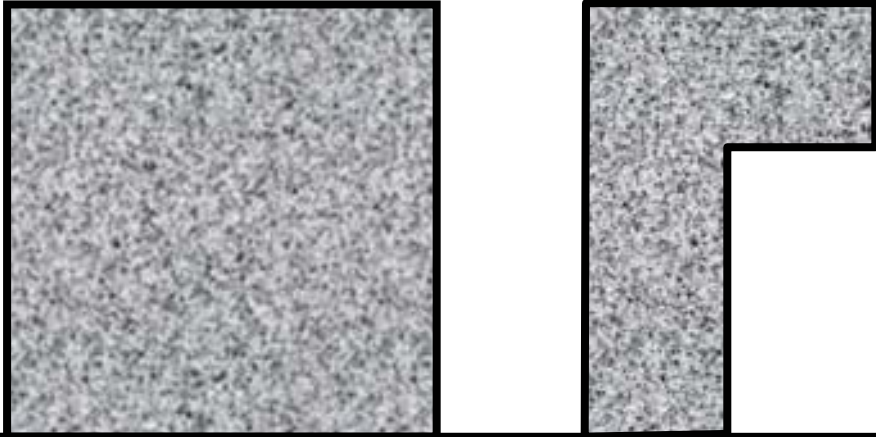

LT

CORTE 1 + CORTE 2

+ PLANTA TECHOS

+ FACHADA LATERAL

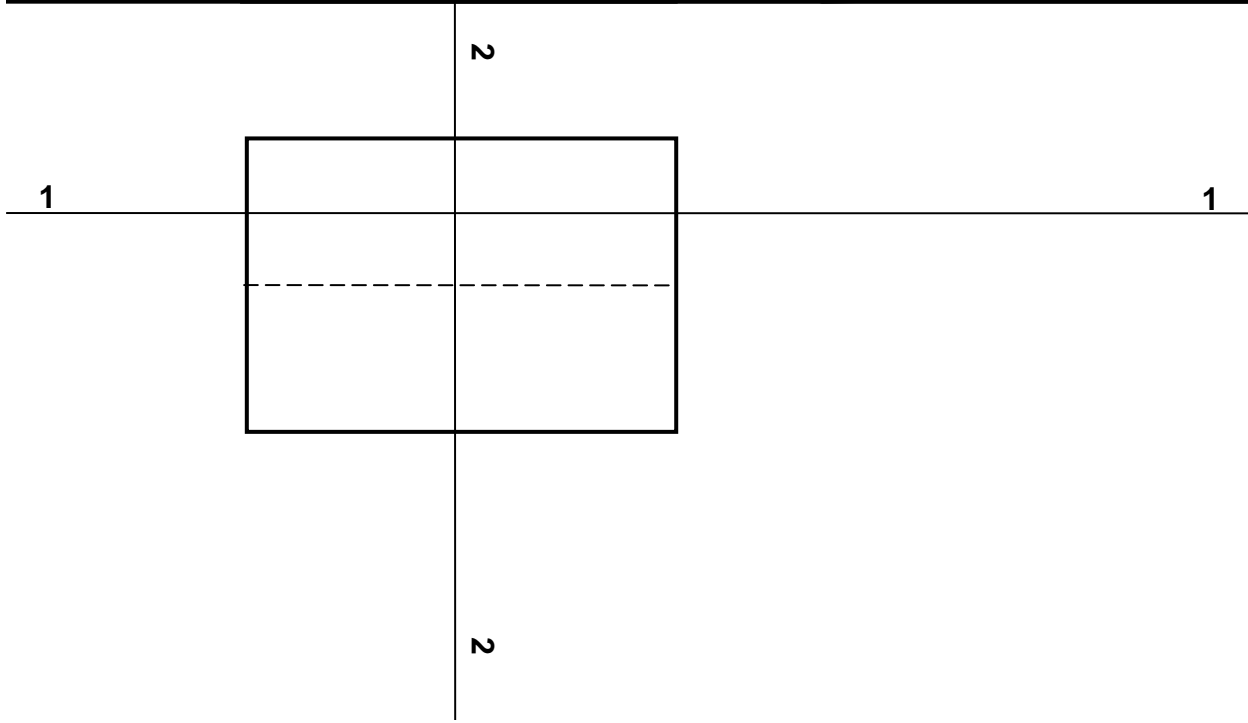

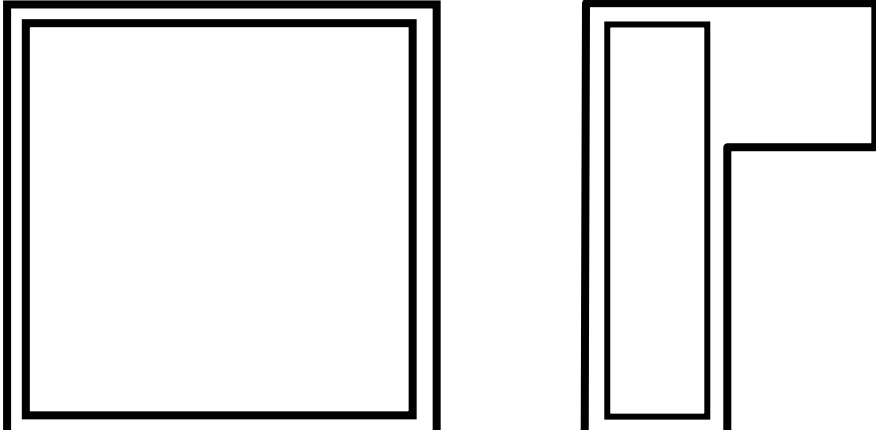

LT

CORTE 1 + CORTE 2

+ PLANTA TECHOS

+ FACHADA LATERAL

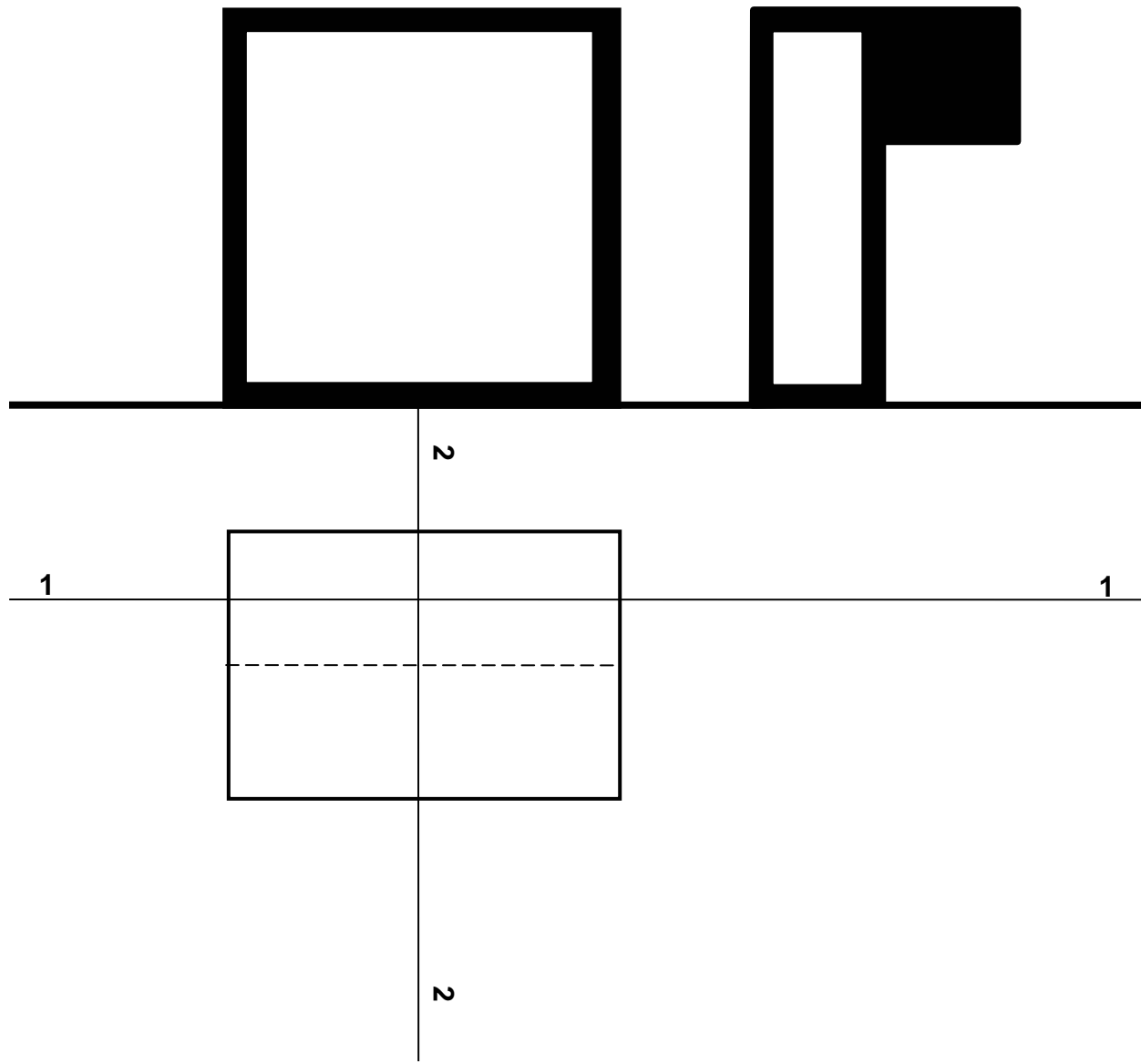

LT

CORTE 1 + CORTE 2

+ PLANTA TECHOS

+ FACHADA LATERAL

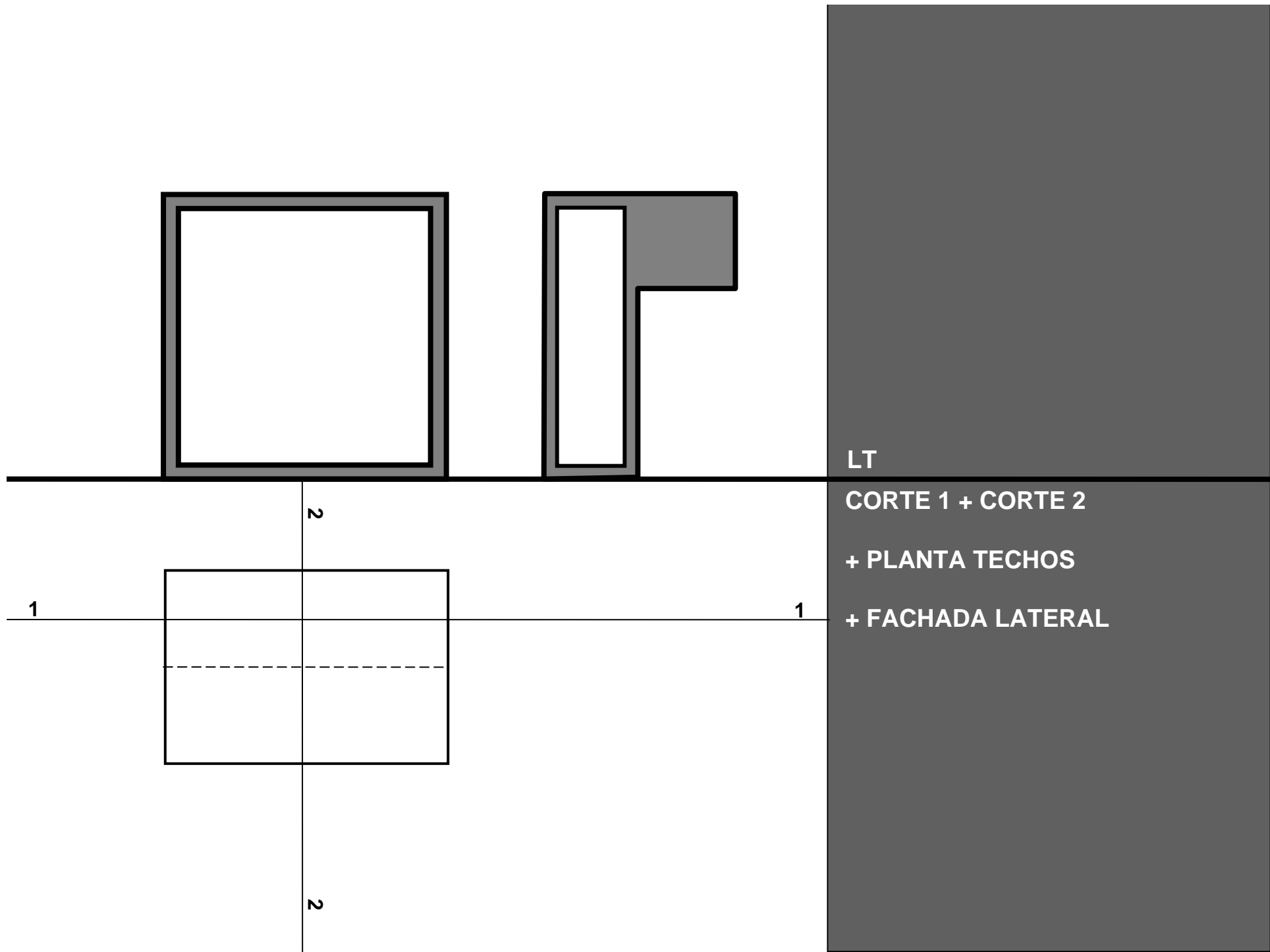

LT

CORTE 1 + CORTE 2

+ PLANTA TECHOS

+ FACHADA LATERAL

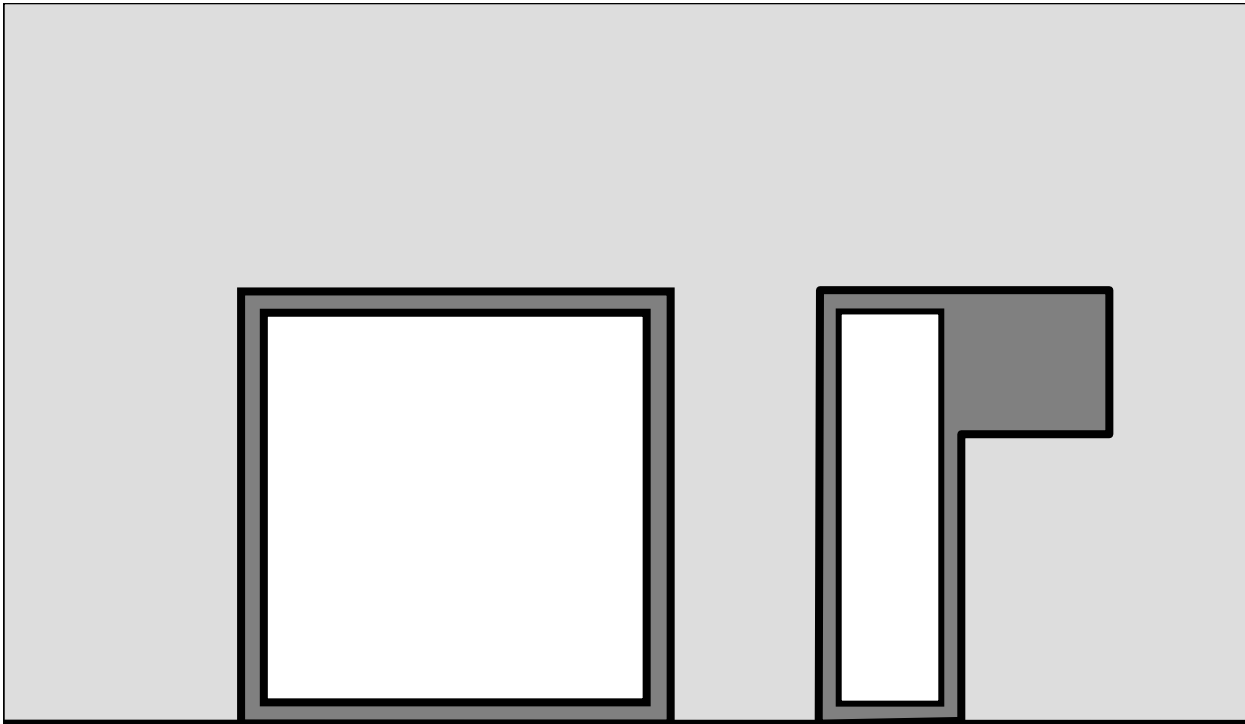

LT

CORTE 1 + CORTE 2

+ PLANTA TECHOS

+ FACHADA LATERAL

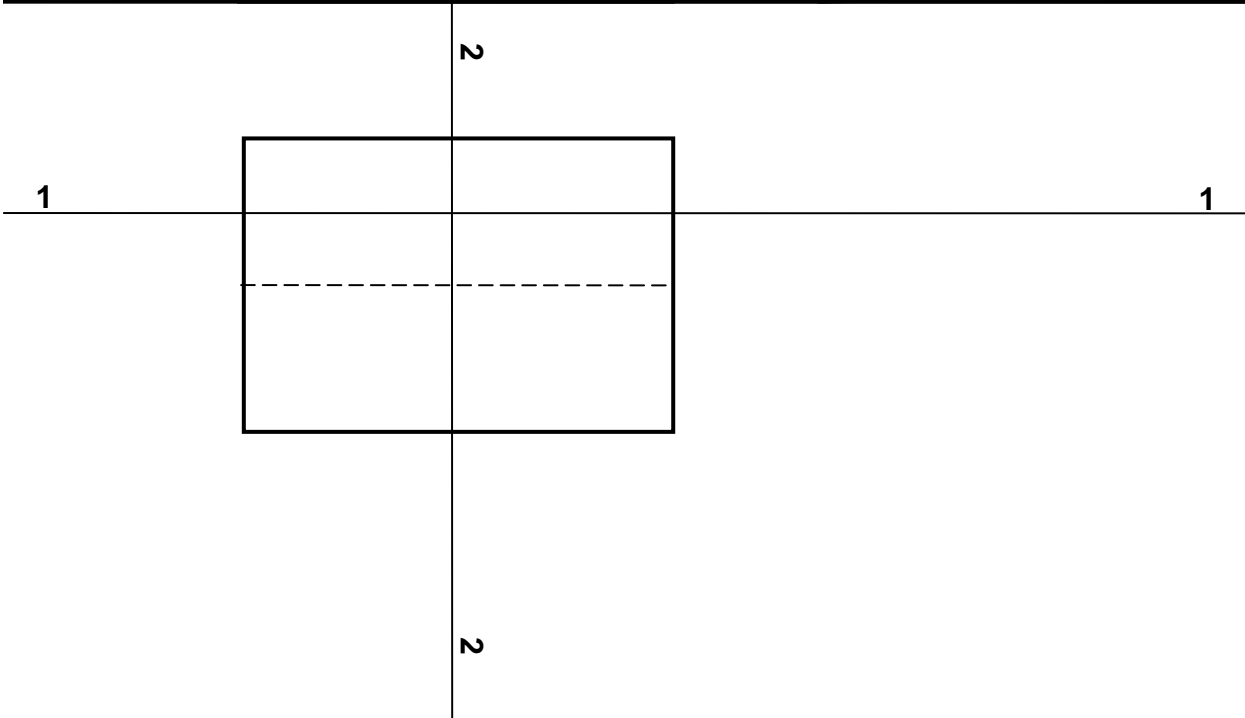



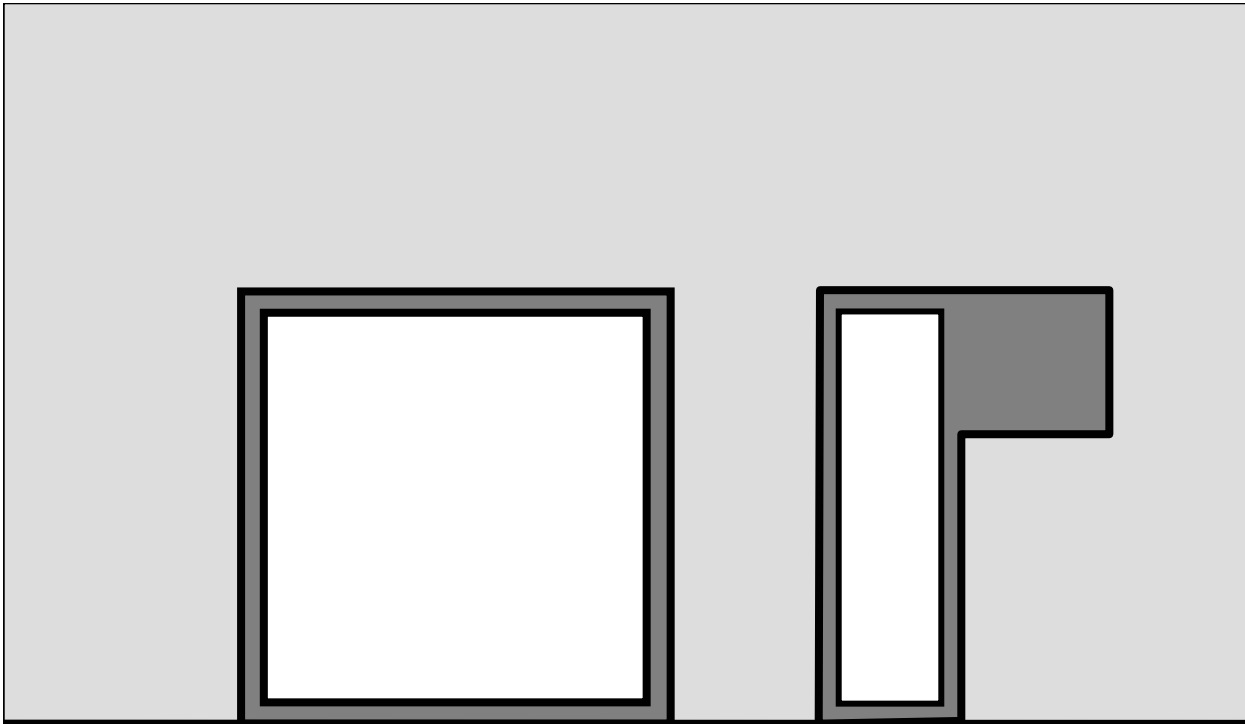

LT

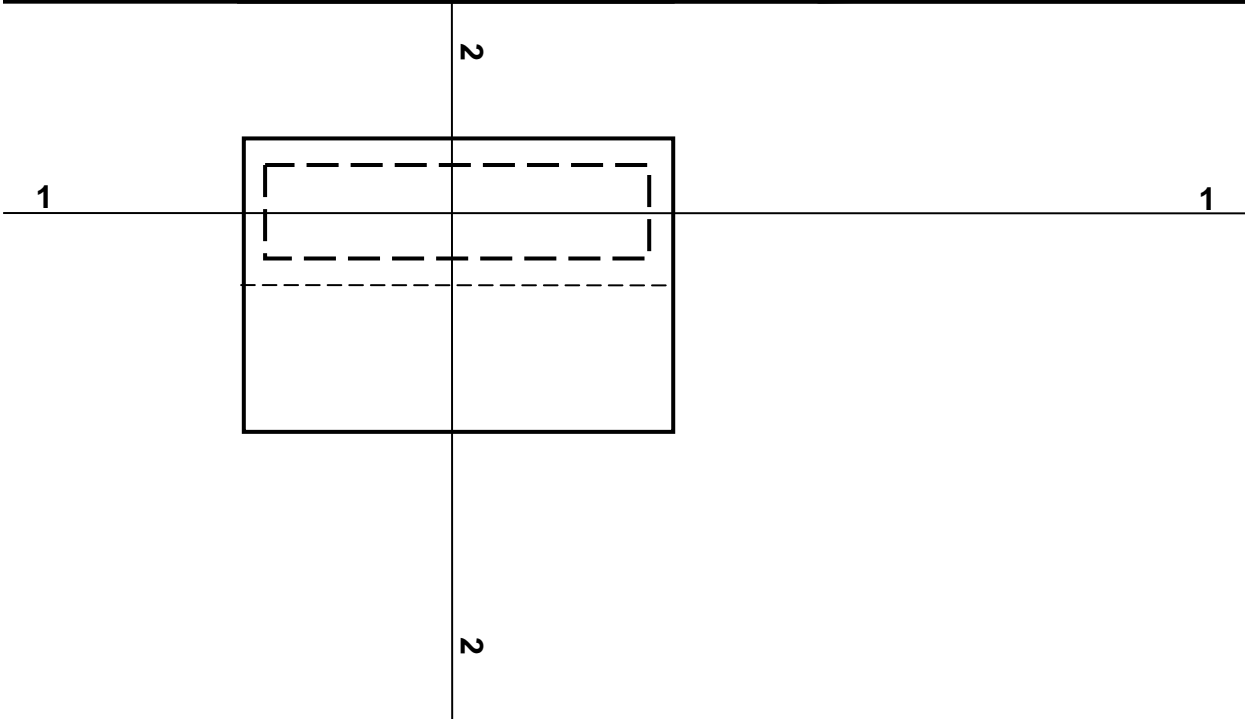

CORTE 1 + CORTE 2

+ PLANTA TECHOS

+ FACHADA LATERAL

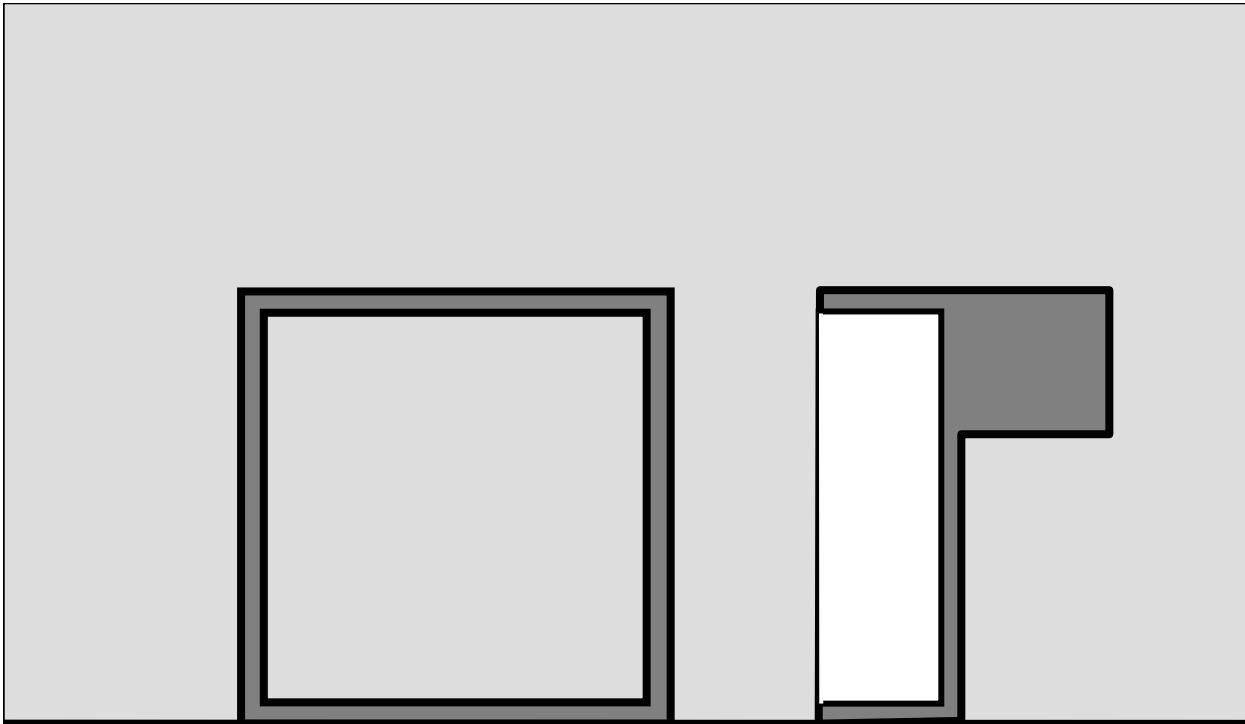

LT

CORTE 1 + CORTE 2

+ PLANTA TECHOS

+ FACHADA LATERAL

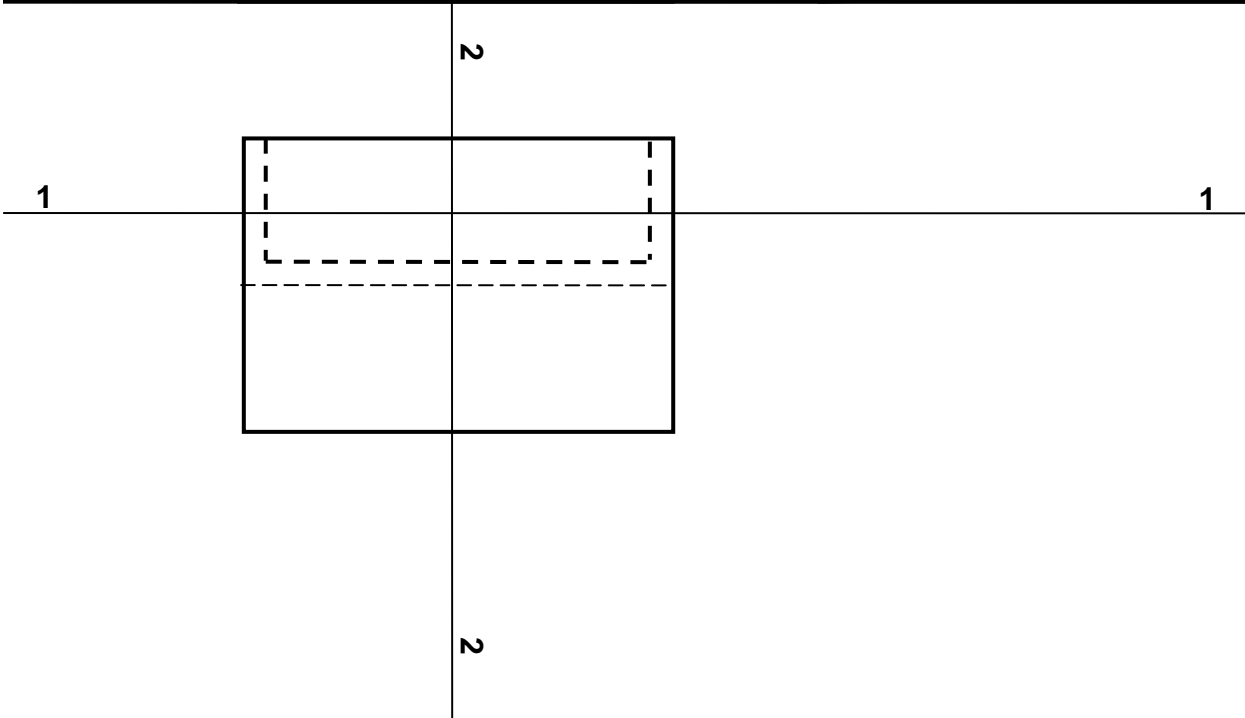

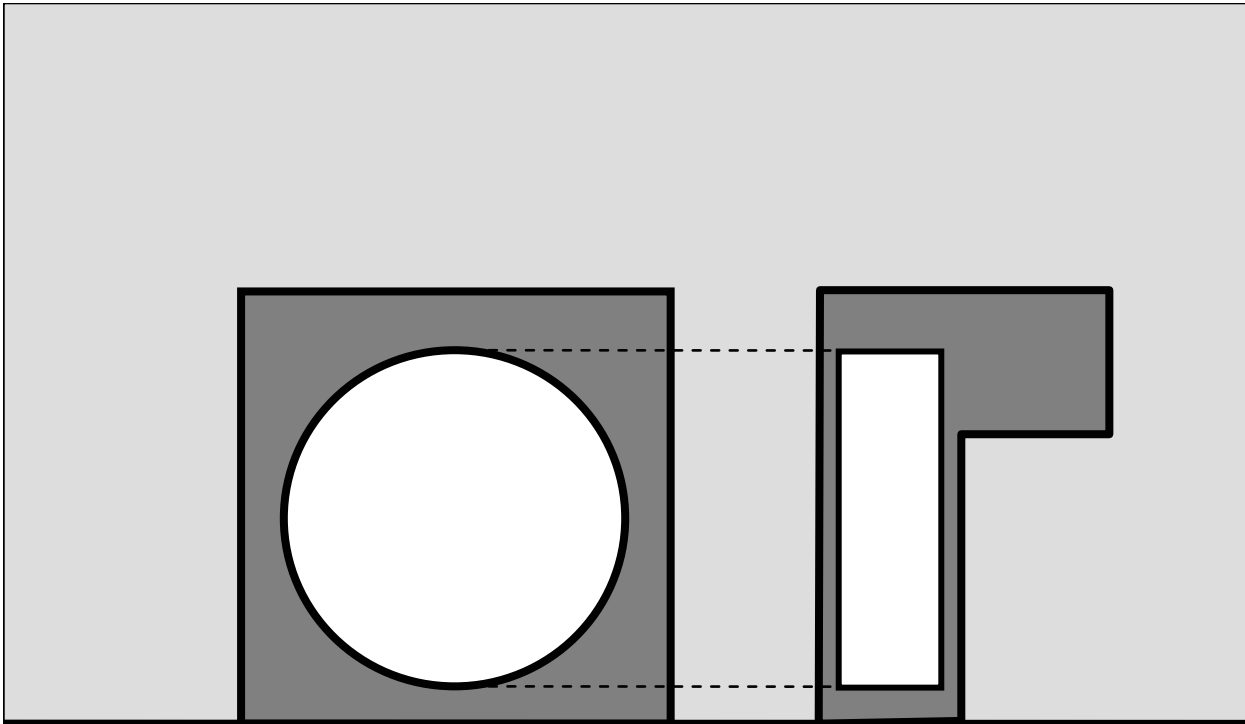

LT

CORTE 1 + CORTE 2

+ PLANTA TECHOS

+ FACHADA LATERAL

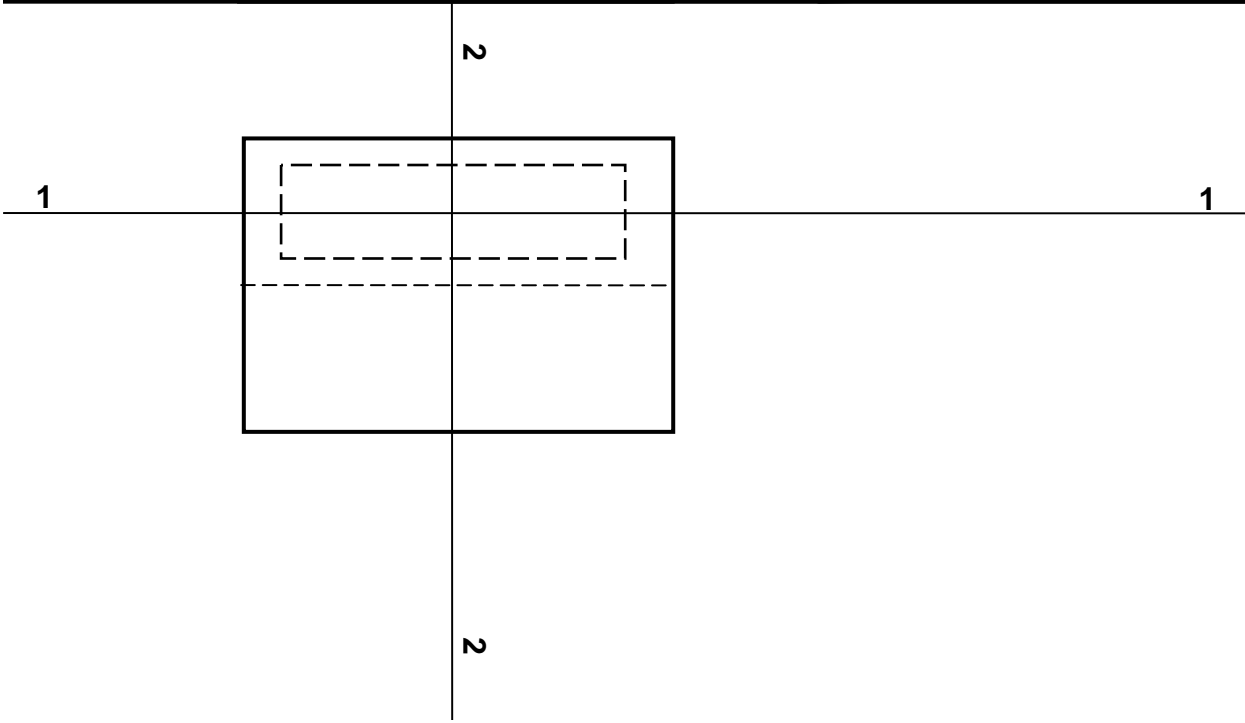

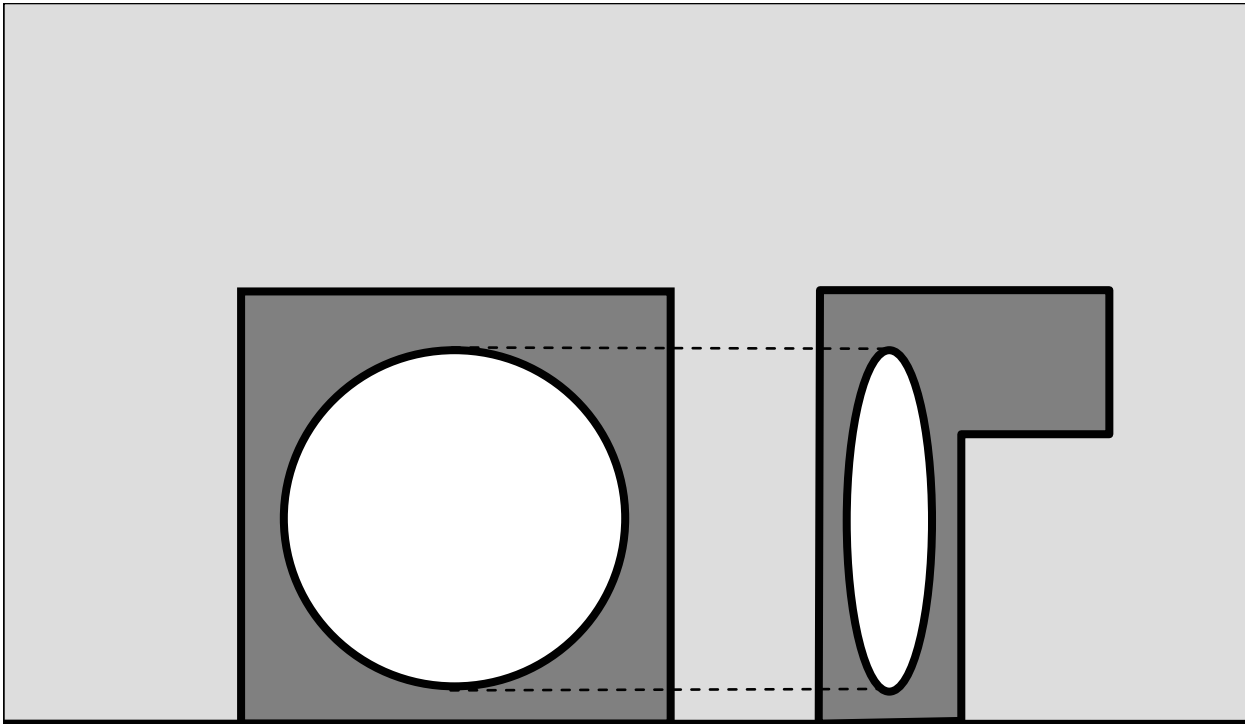

LT

CORTE 1 + CORTE 2

+ PLANTA TECHOS

+ FACHADA LATERAL

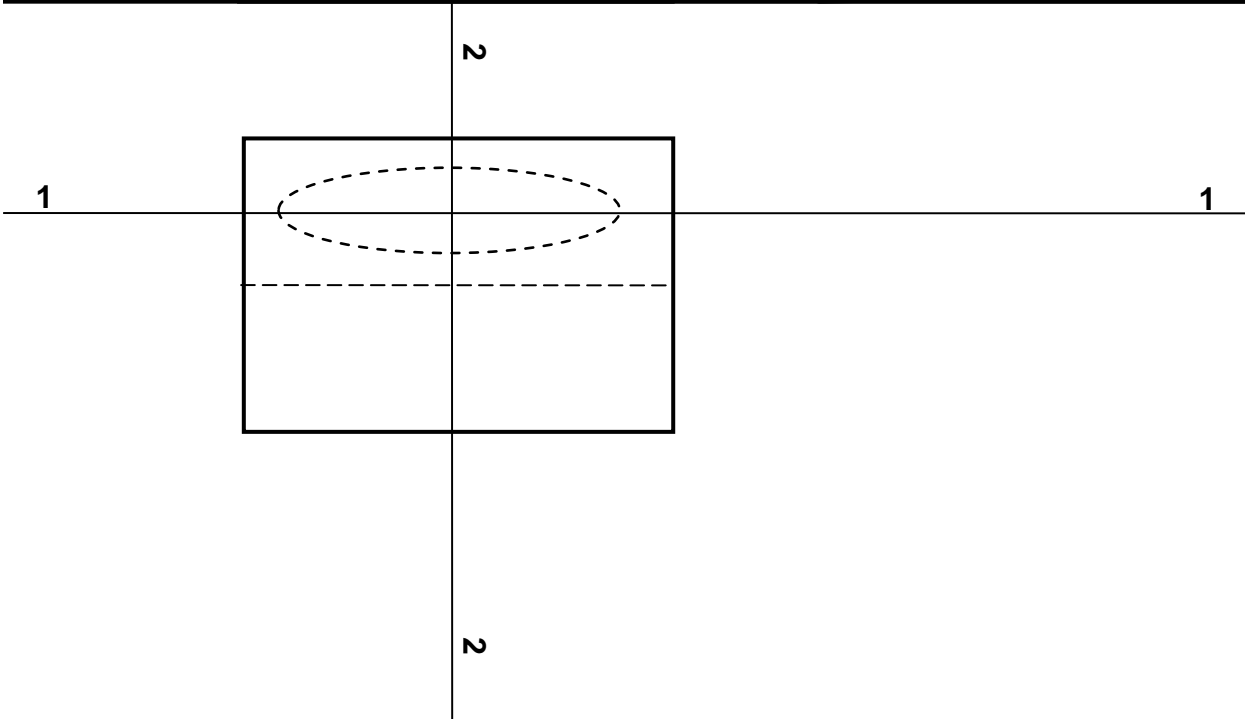

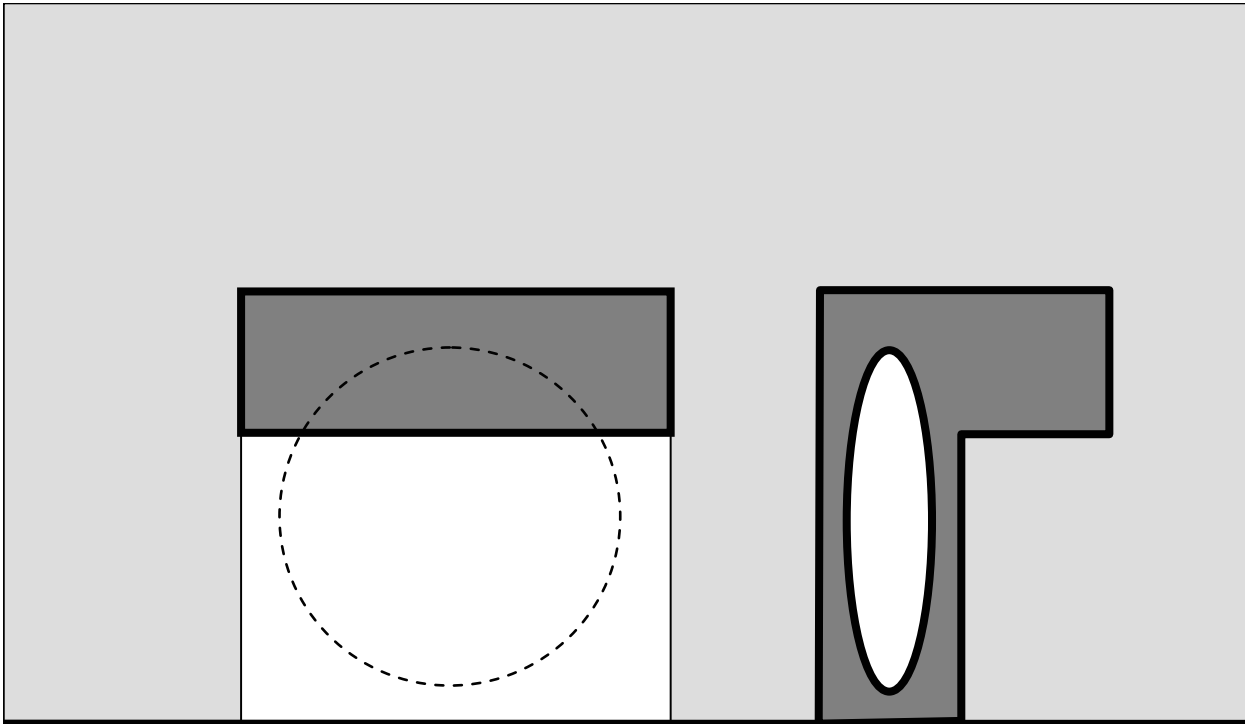

LT

CORTE 1 + CORTE 2

+ PLANTA TECHOS

+ FACHADA LATERAL

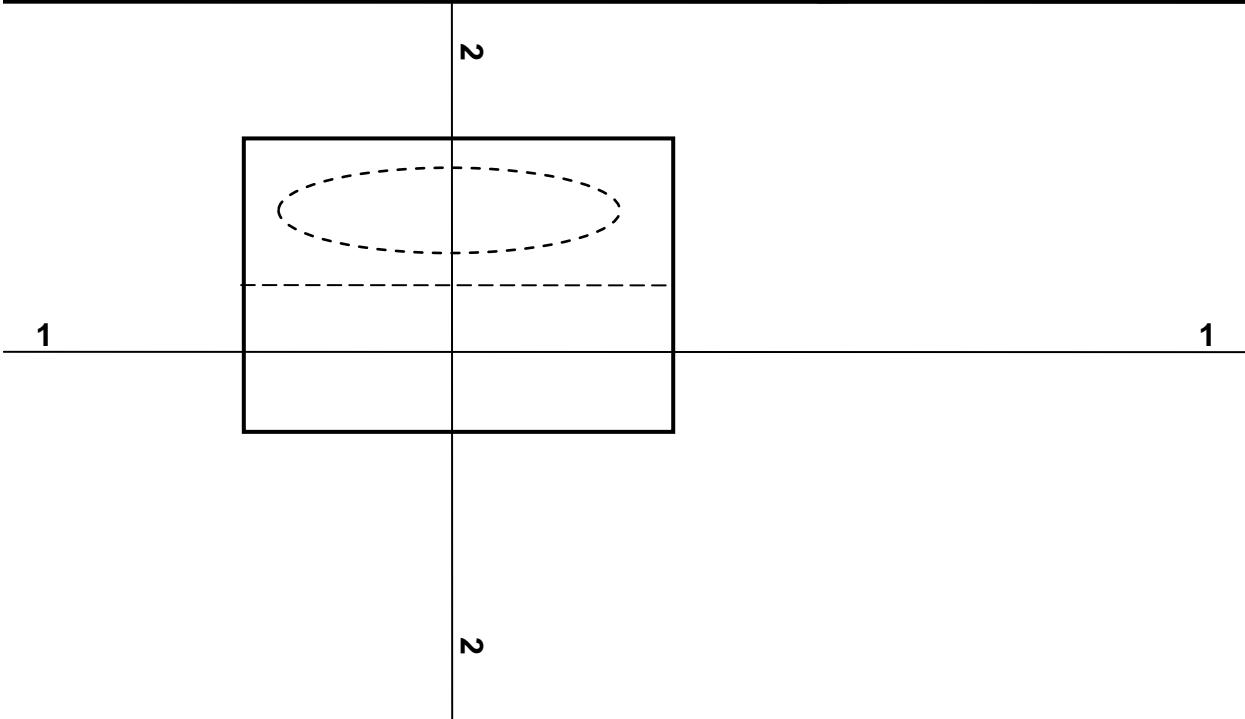

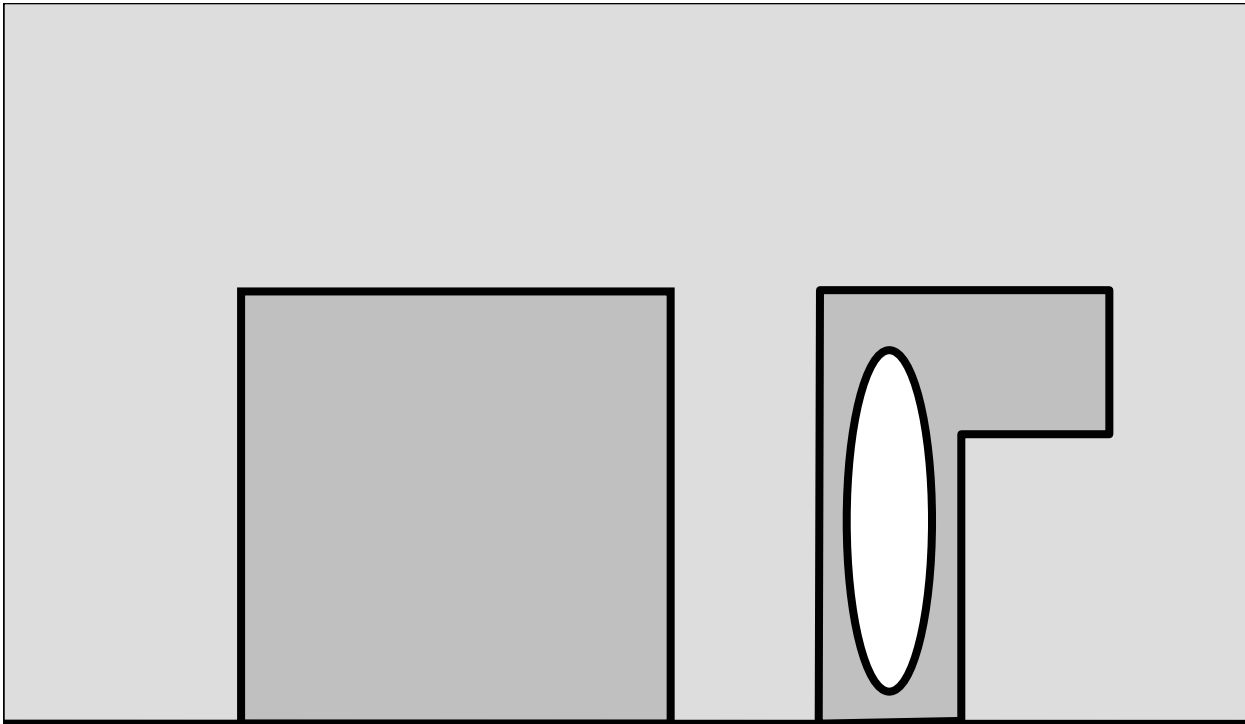

LT

CORTE 1 + CORTE 2

+ PLANTA TECHOS

+ FACHADA LATERAL

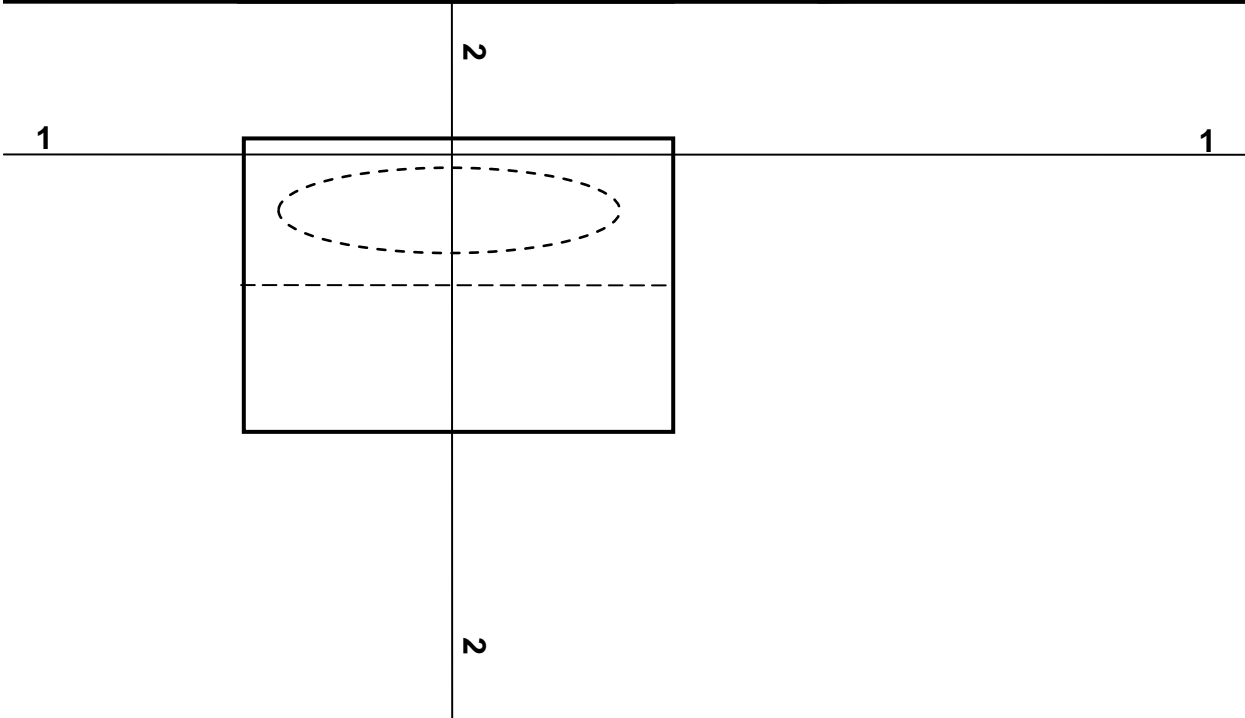

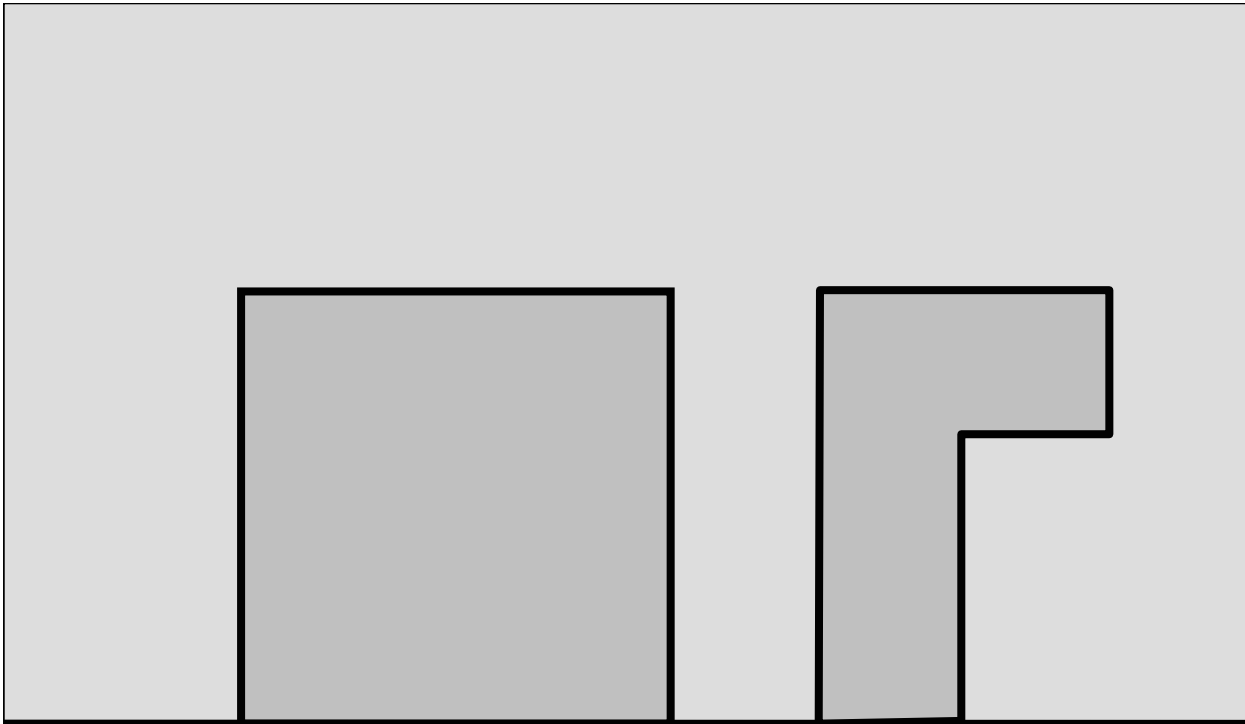

LT

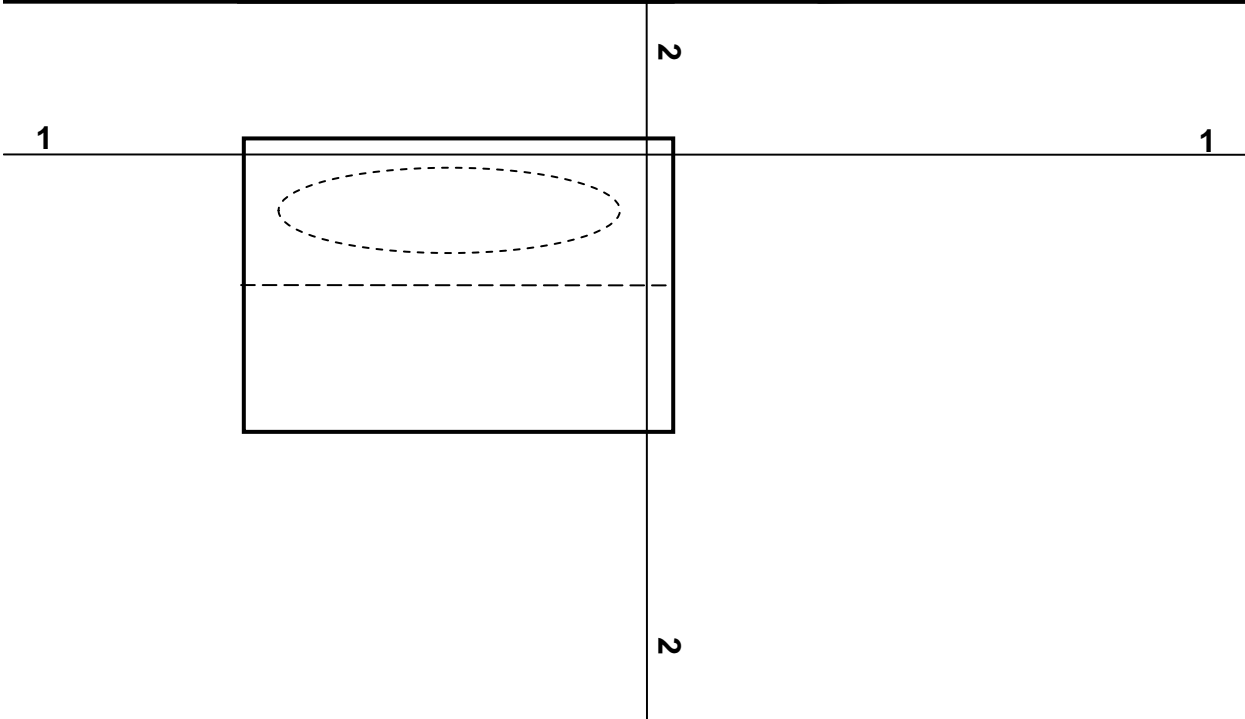

CORTE 1 + CORTE 2

+ PLANTA TECHOS

+ FACHADA LATERAL

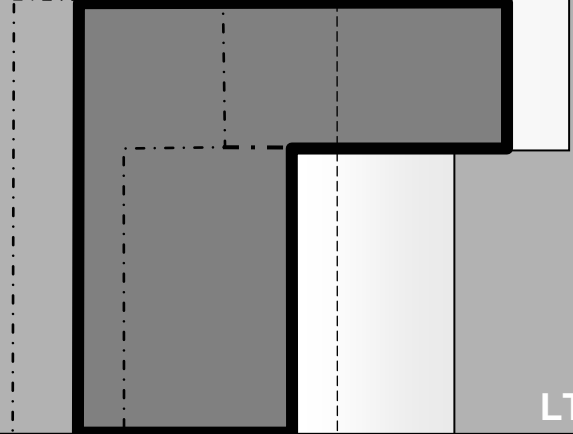
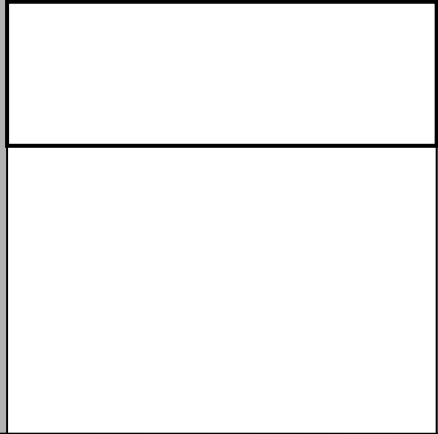

LT

CORTE 1

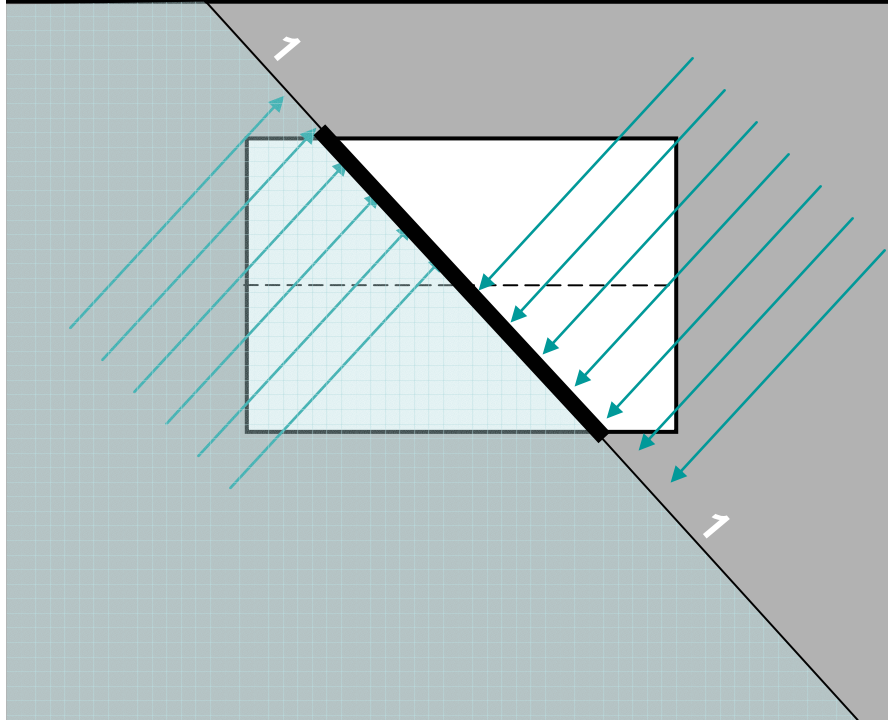



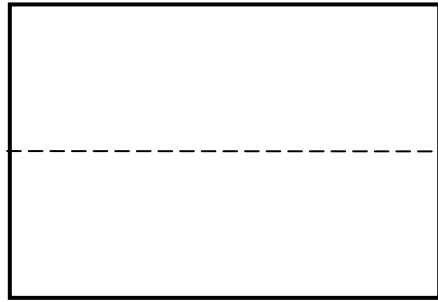
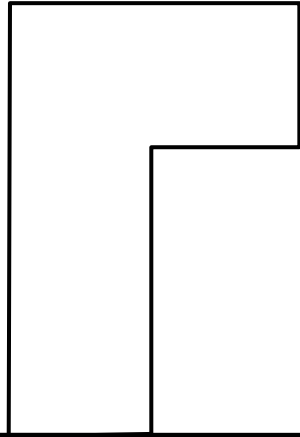
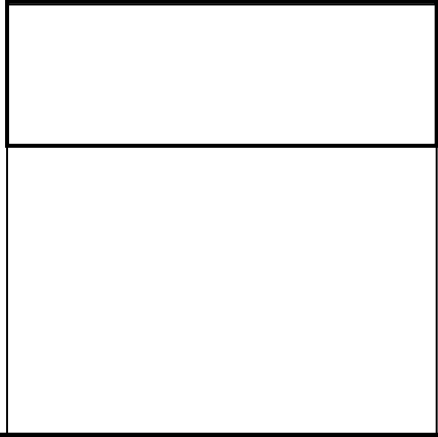

LT

FACHADA FRONTAL

+ PLANTA TECHOS

+ FACHADA LATERAL

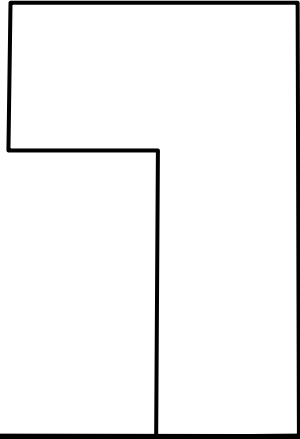

FACHADA LATERAL

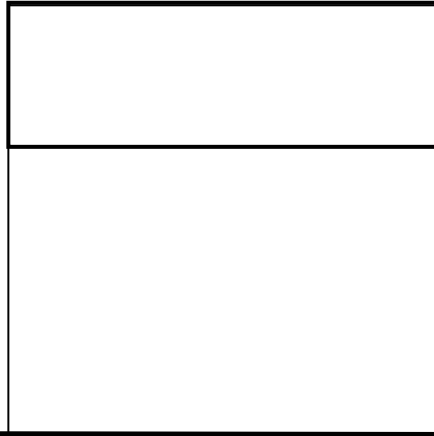

FACHADA FRONTAL

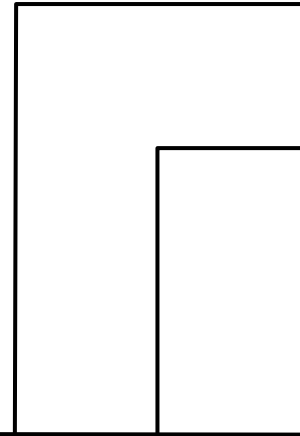

FACHADA LATERAL

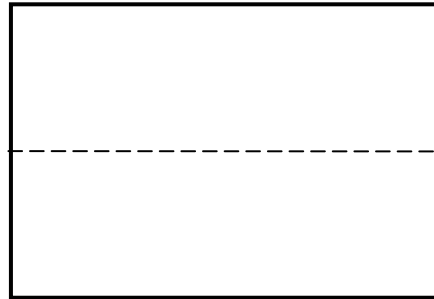

PLANTA TECHOS

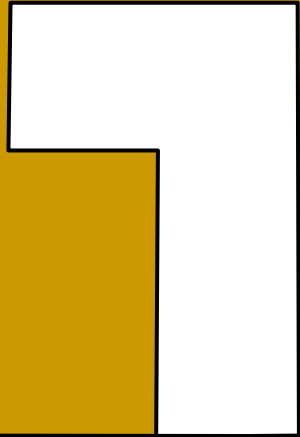

FACHADA LATERAL



FACHADA FRONTAL

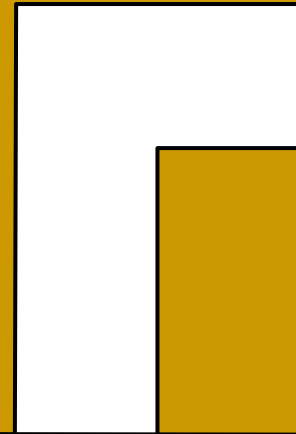

FACHADA LATERAL

LT

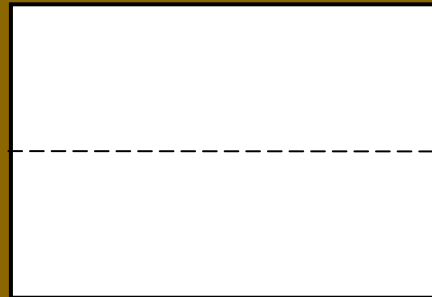

PLANTA TECHOS

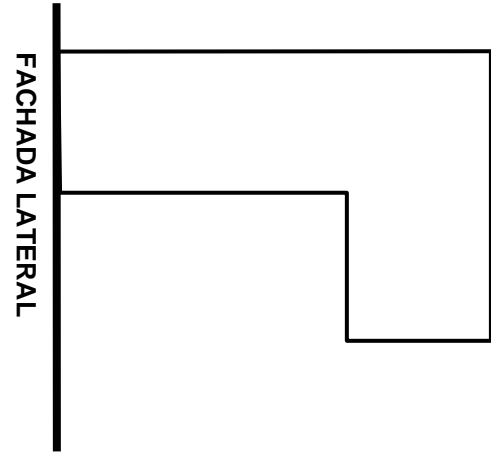
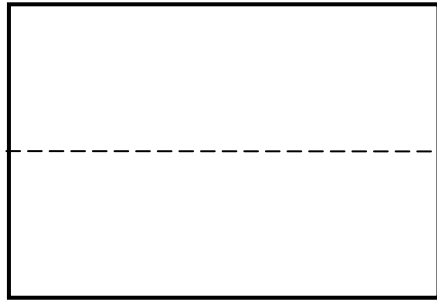
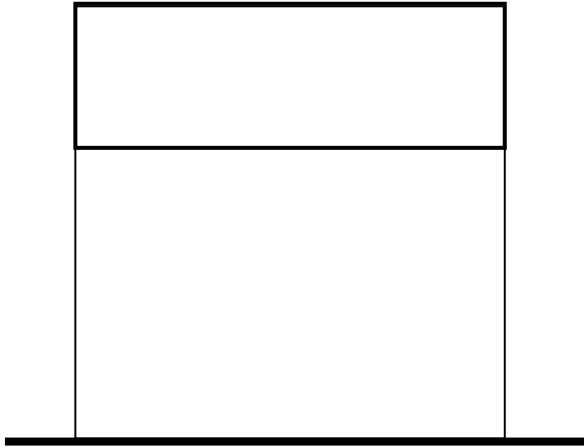
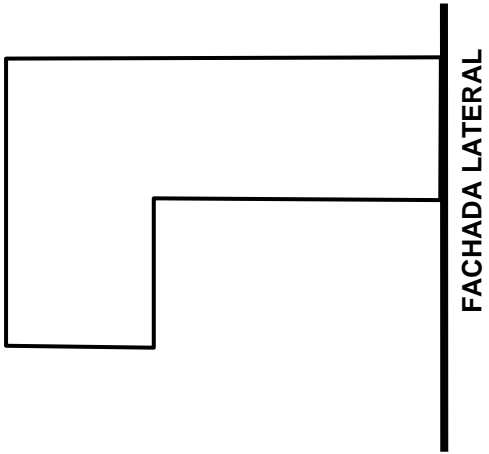

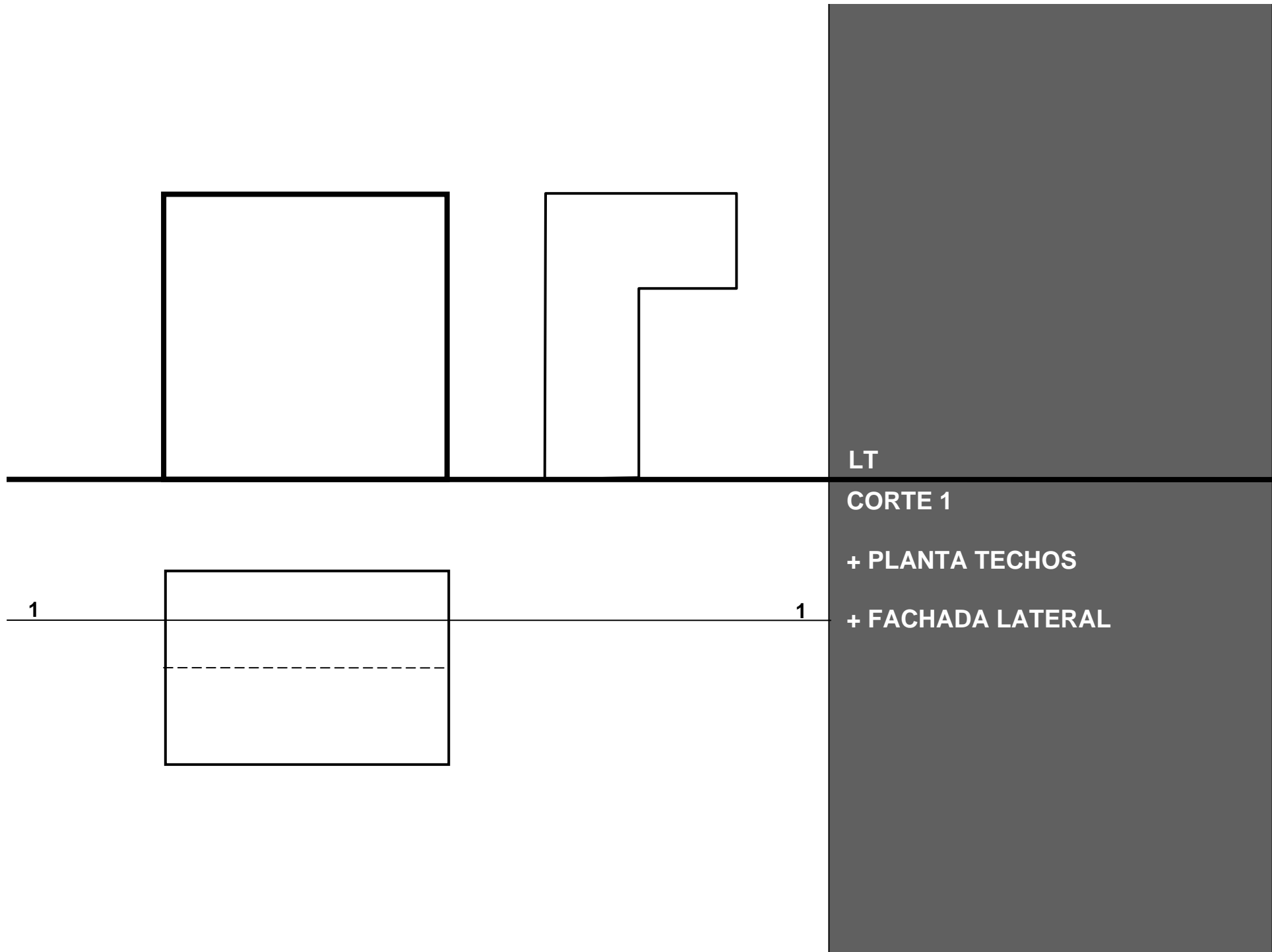

LT

CORTE 1

+ PLANTA TECHOS

+ FACHADA LATERAL

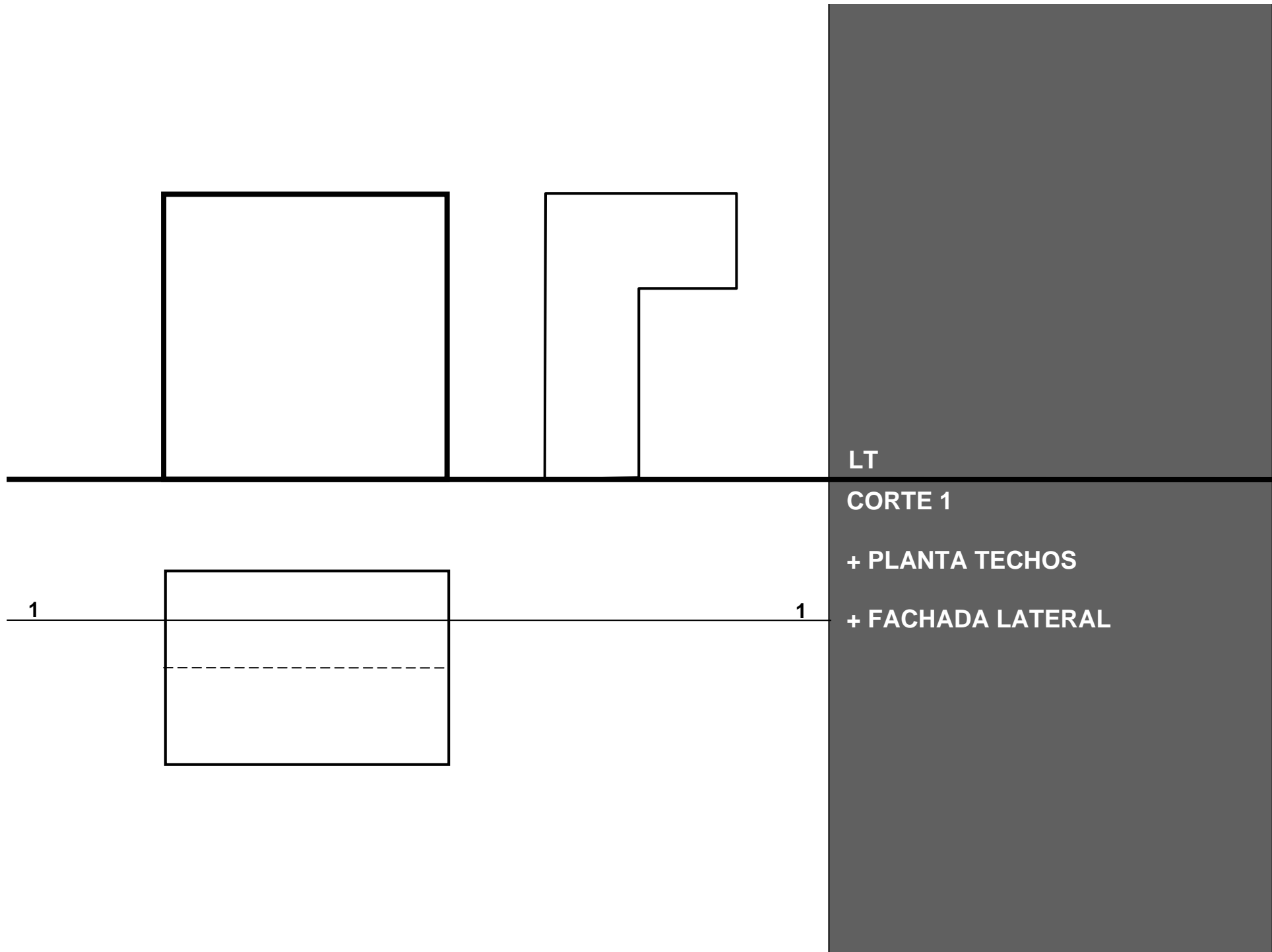

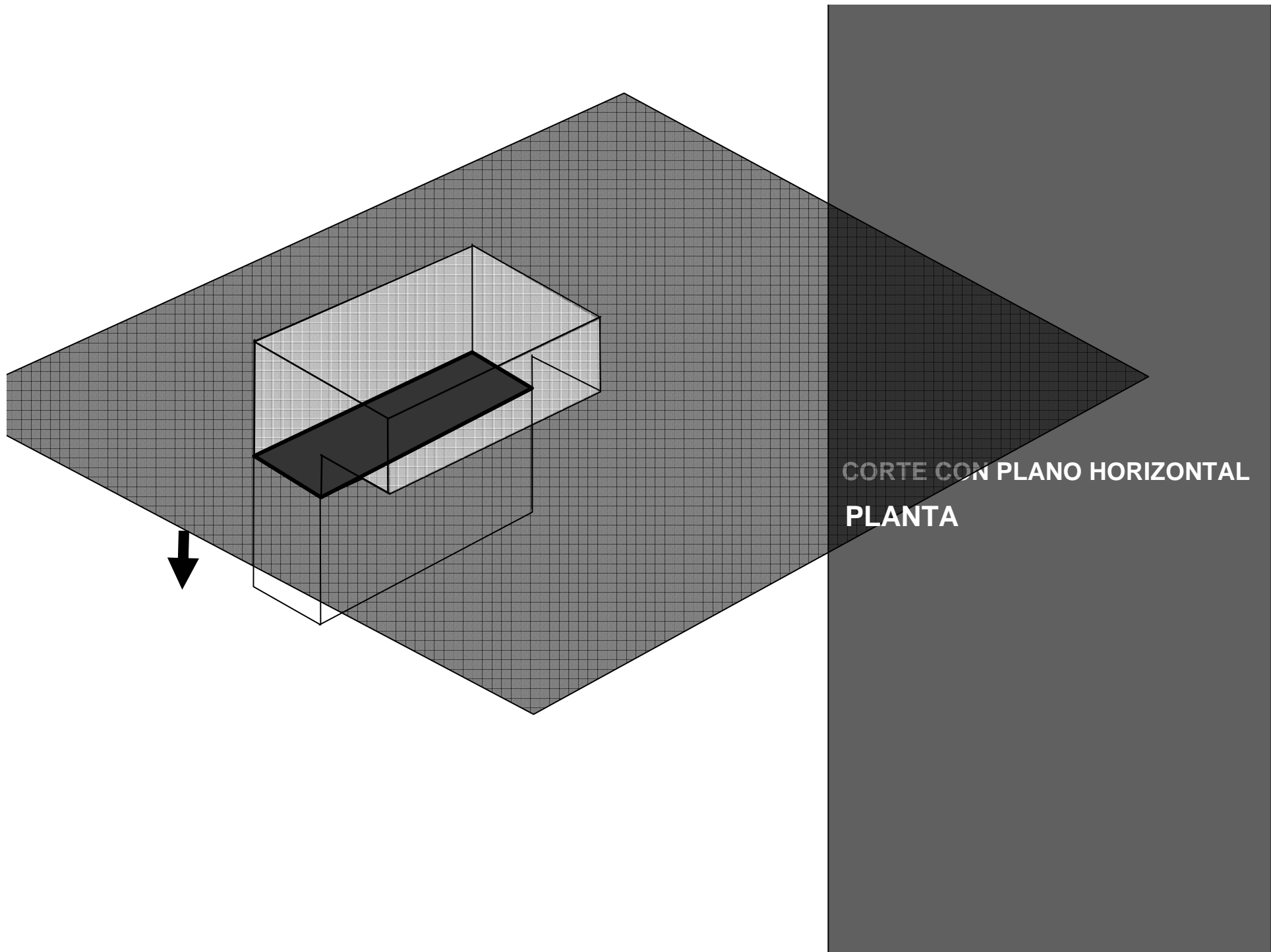

CORTE CON PLANO HORIZONTAL  
PLANTA

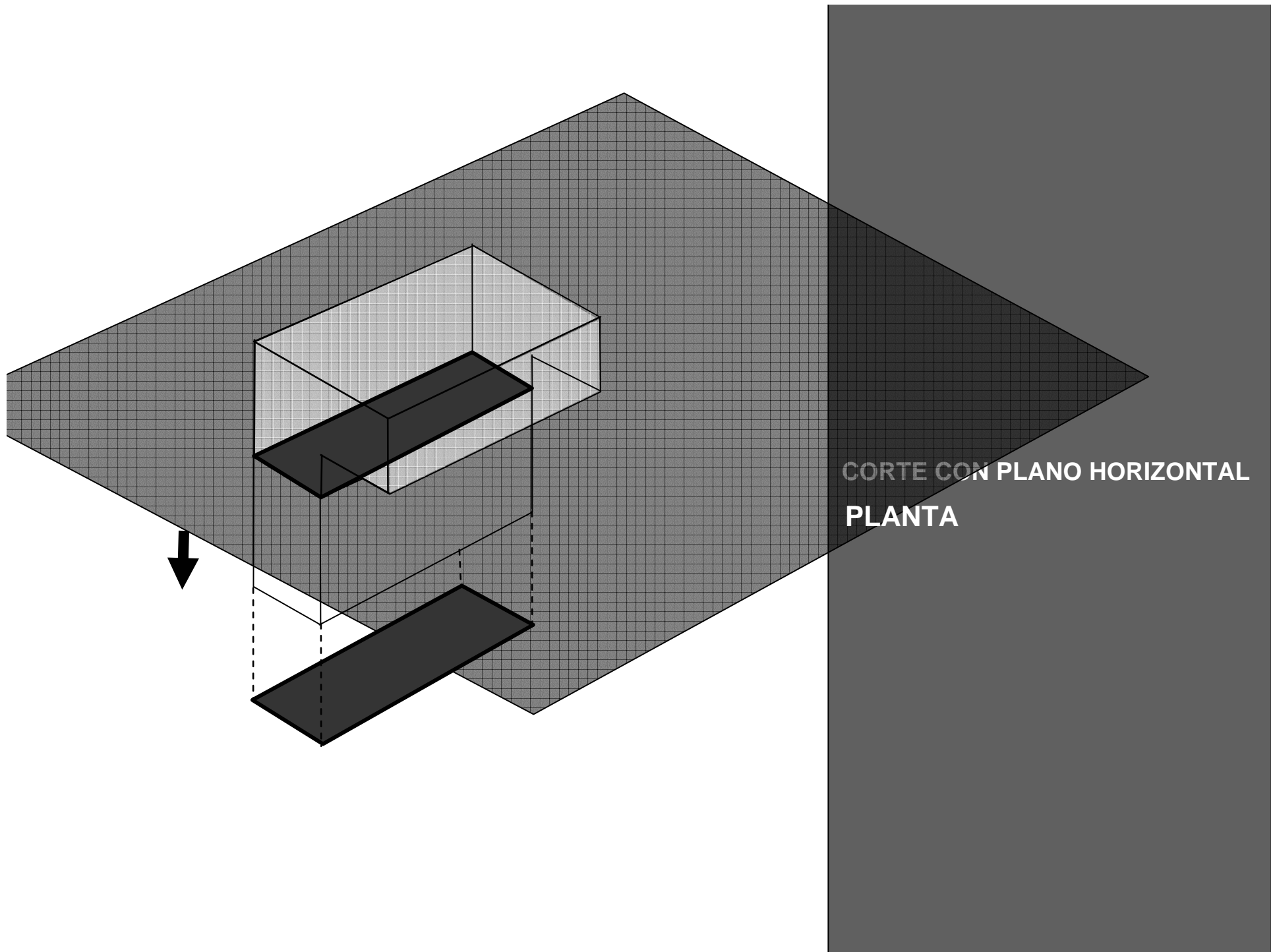

CORTE CON PLANO HORIZONTAL  
PLANTA



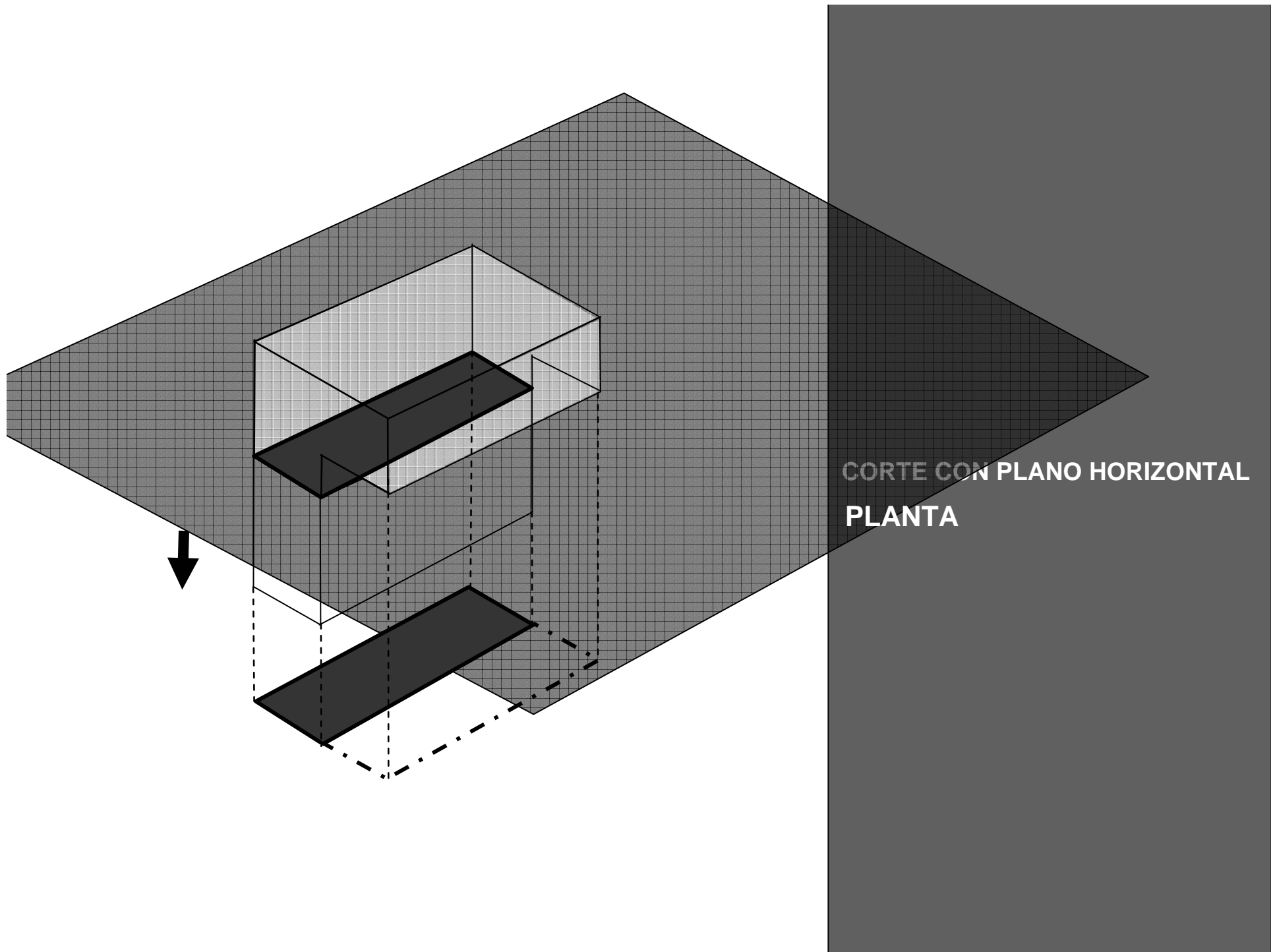

CORTE CON PLANO HORIZONTAL  
PLANTA

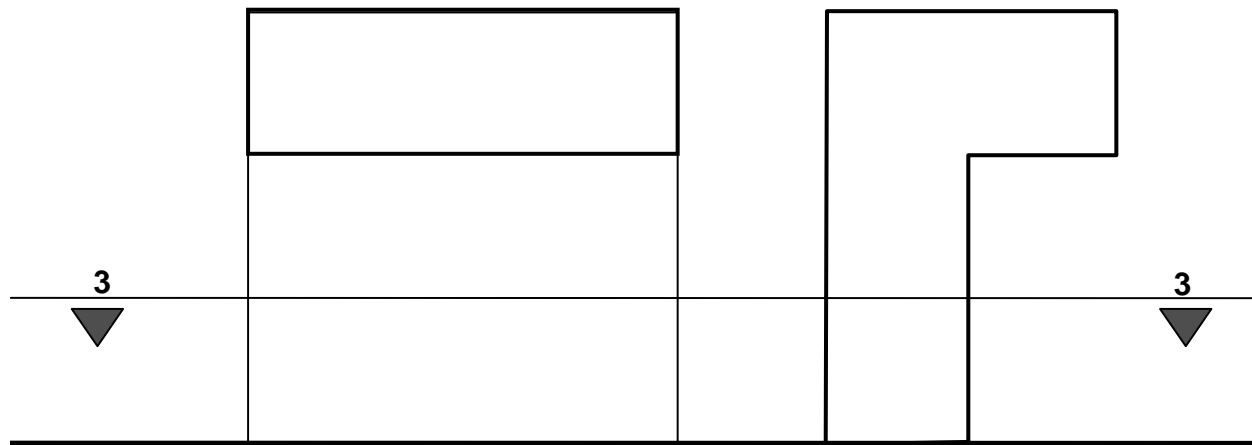

FACHADA FRONTAL

FACHADA LATERAL

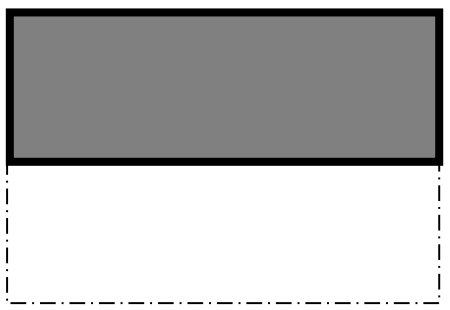

PLANTA NIVEL XXX

LT

FACHADA FRONTAL

+ PLANTA NIVEL XXX ó CORTE 3

+ FACHADA LATERAL

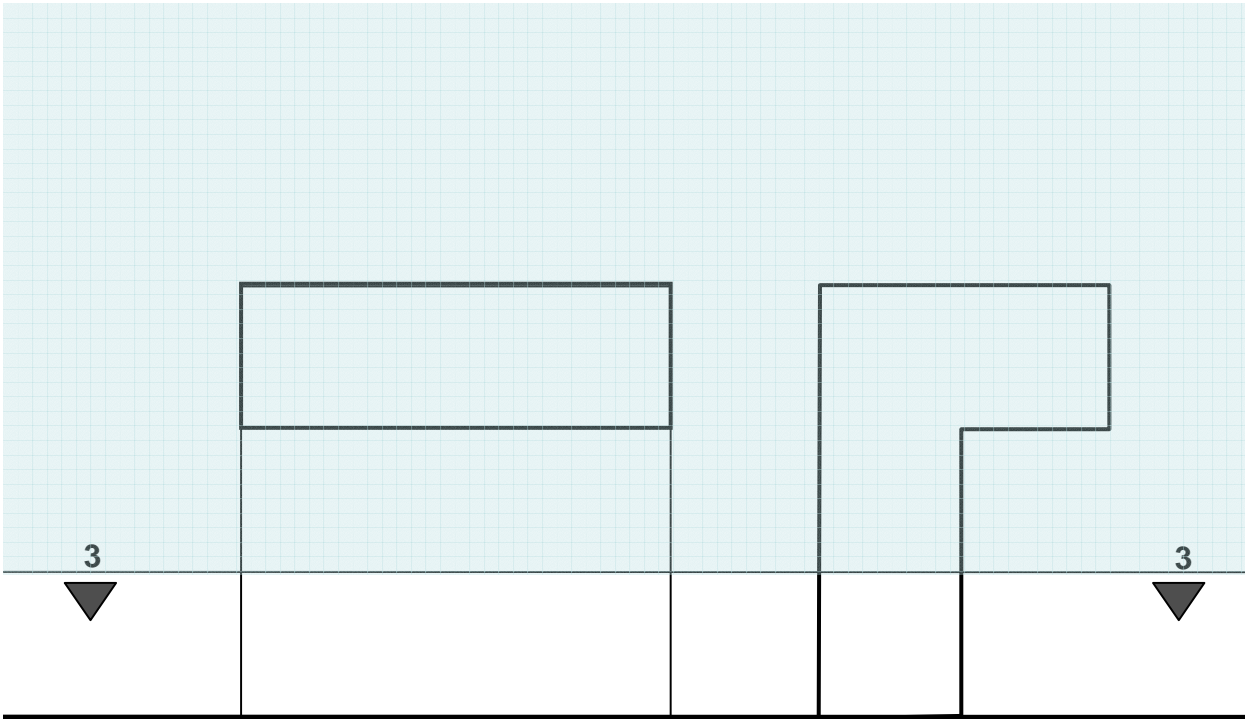

FACHADA FRONTAL

FACHADA LATERAL



PLANTA NIVEL XXX

LT



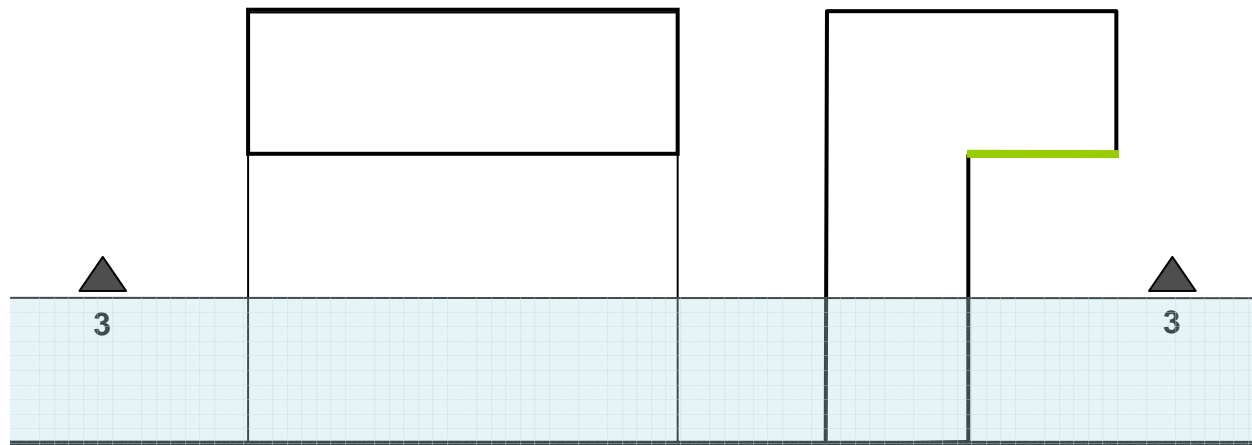

FACHADA FRONTAL

FACHADA LATERAL

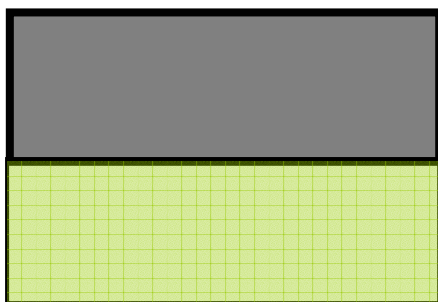

PLANTA NIVEL XXX



# ESTRUCTURA GEOMÉTRICA SIN EXPRESIÓN

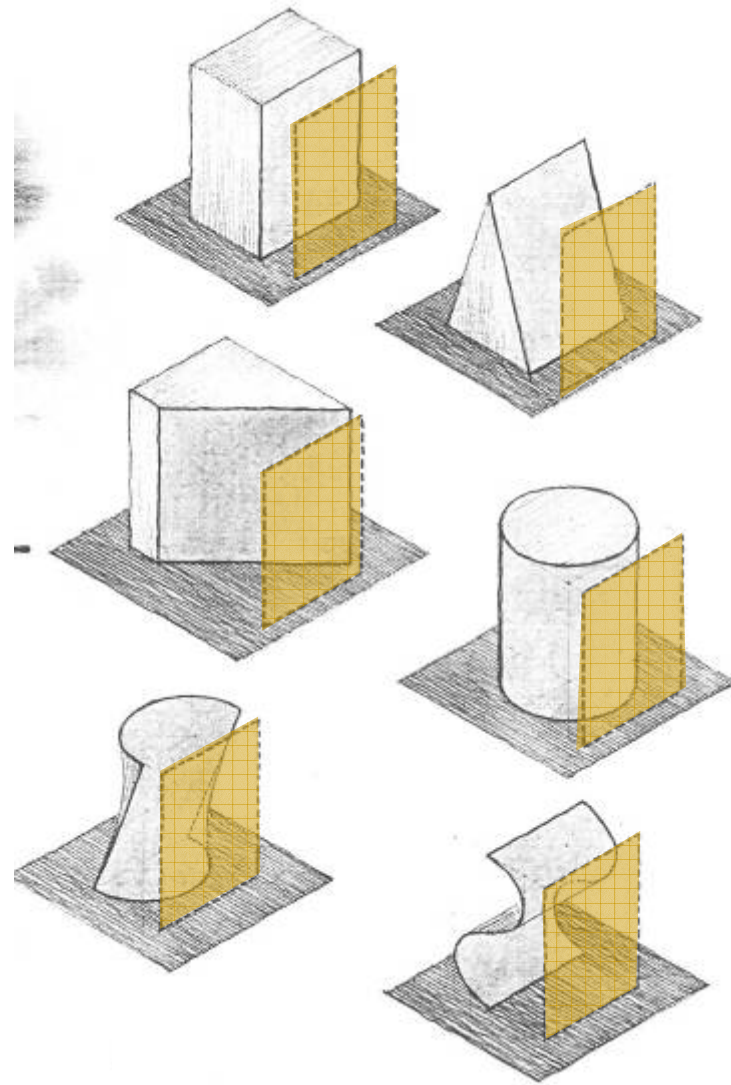
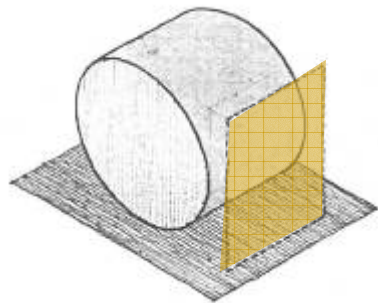
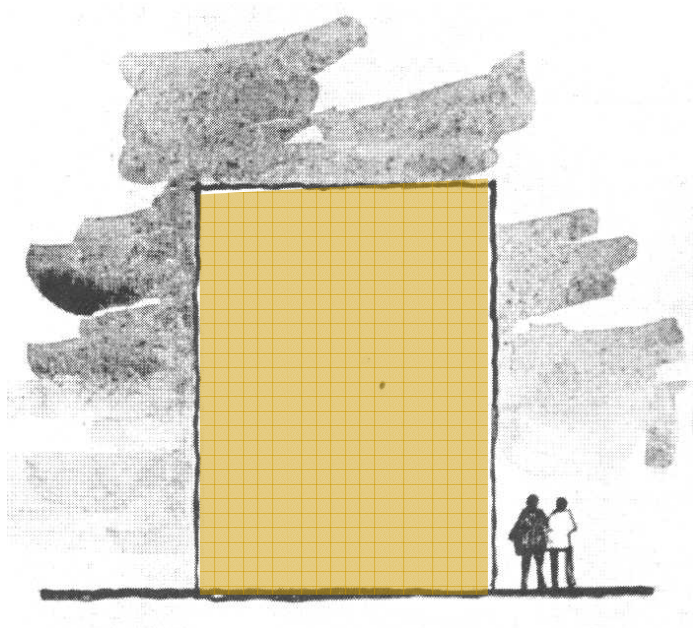

**LT**

**FACHADA**

**PLANTA**

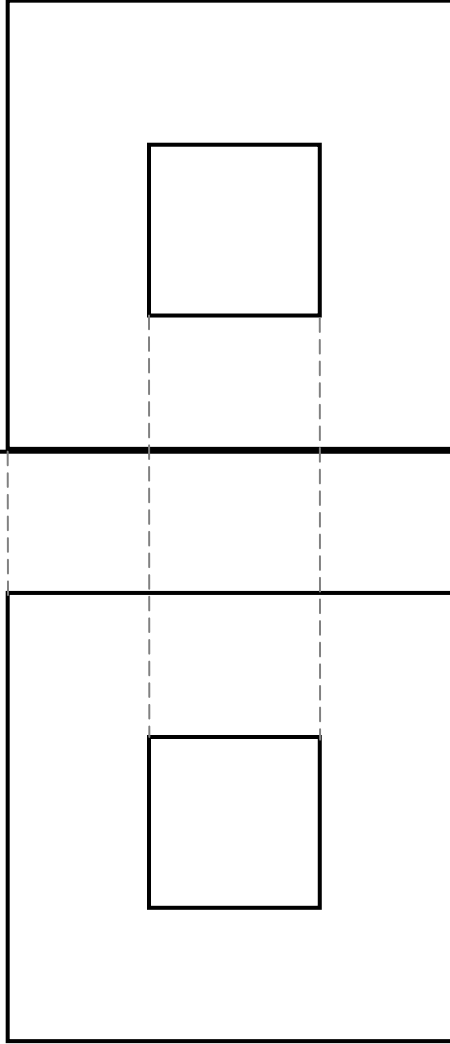

**fin**