

MTE I

PROYECCIONES CILÍNDRICAS O PARALELAS

PROYECCIONES CÓNICAS

DIÉDRICO ORTOGONAL

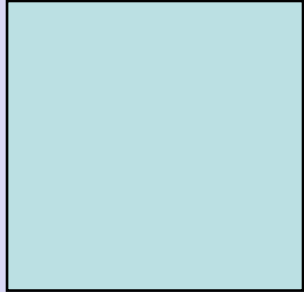

LT

FACHADA



PLANTA

AXONOMETRÍA

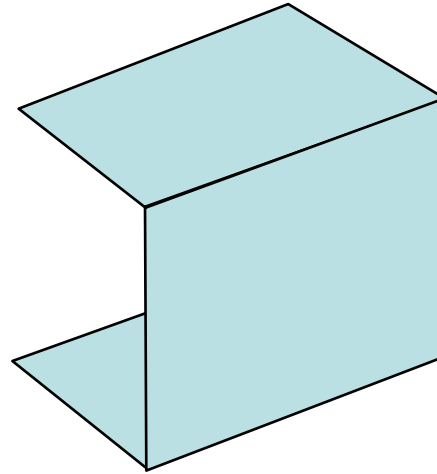

PERSPECTIVA CÓNICA

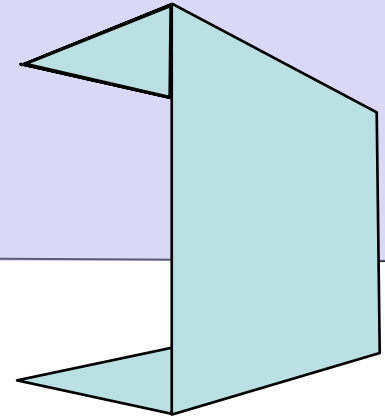

LH

PROYECCIONES CILÍNDRICAS O PARALELAS

DIÉDRICO ORTOGONAL

LT

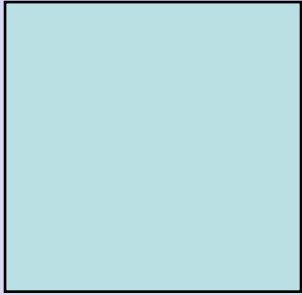

FACHADA



PLANTA



FACHADA LATERAL 1

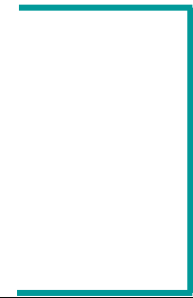

FACHADA LATERAL 2

PROYECCIONES CILÍNDRICAS O PARALELAS

DIÉDRICO ORTOGONAL

LT

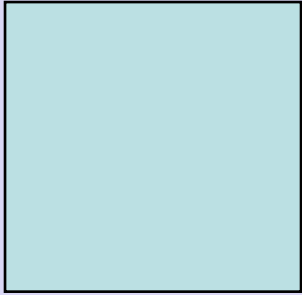

2

FACHADA



1

PLANTA



FACHADA LATERAL 1

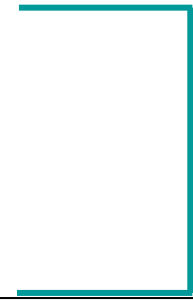

FACHADA LATERAL 2

3

PROYECCIONES CILÍNDRICAS O PARALELAS

PROYECCIONES CÓNICAS

DIÉDRICO ORTOGONAL

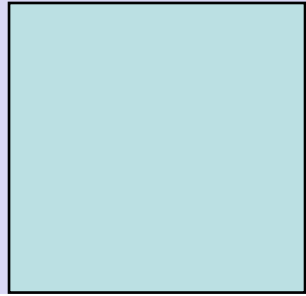

CORTE



AXONOMETRÍA

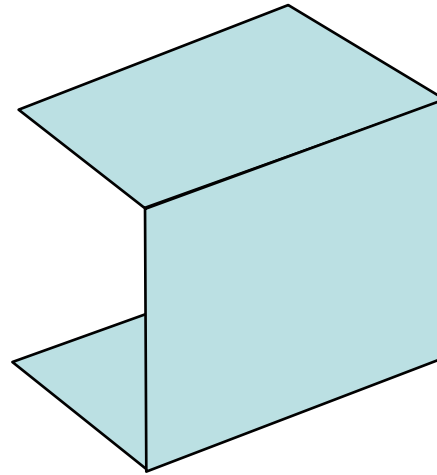

PERSPECTIVA CÓNICA

LH

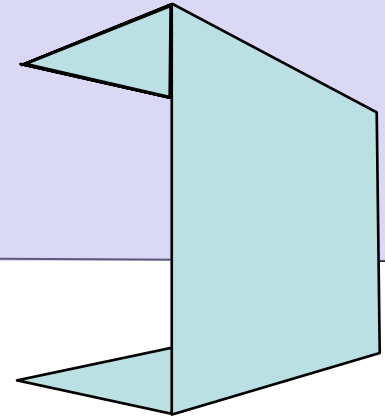

PROYECCIONES CILÍNDRICAS O PARALELAS

PROYECCIONES CÓNICAS

DIÉDRICO ORTOGONAL

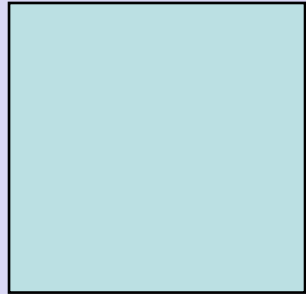

LT

CORTE



PLANTA

AXONOMETRÍA

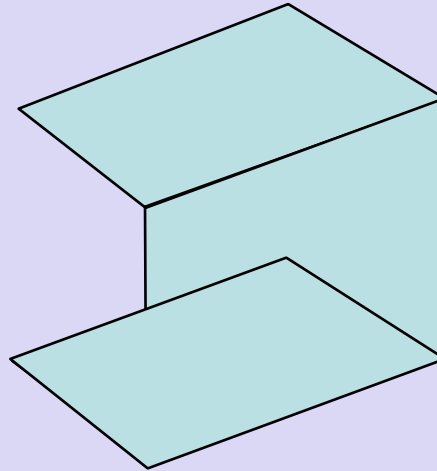

PERSPECTIVA CÓNICA

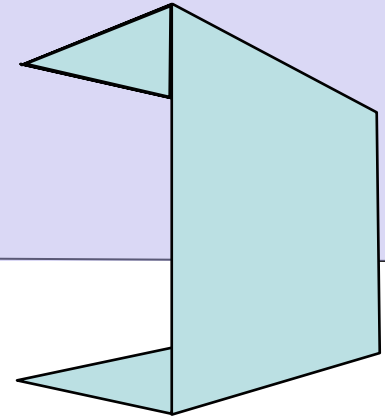

LH

AXONOMETRÍA

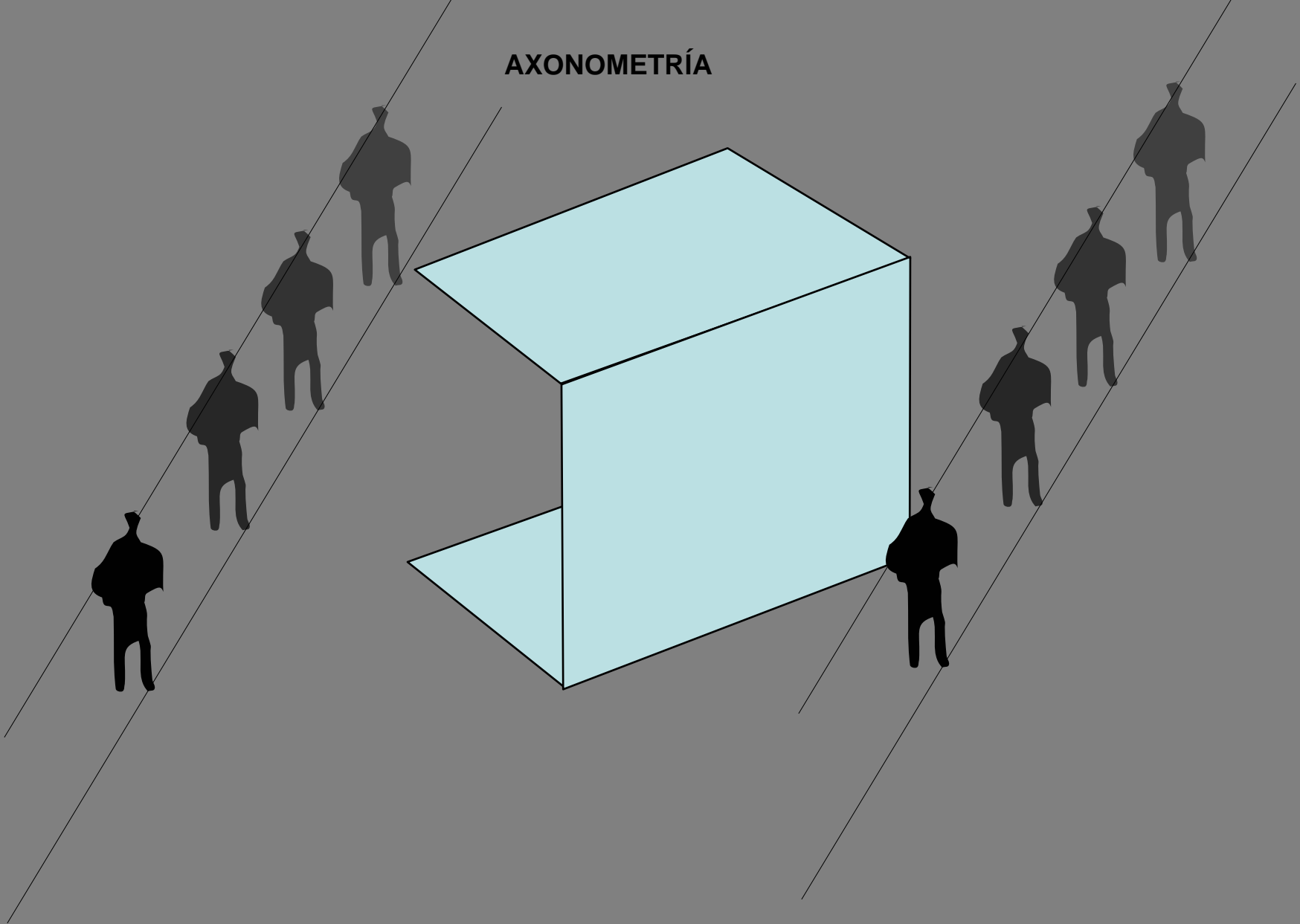

PERSPECTIVA CÓNICA

LH

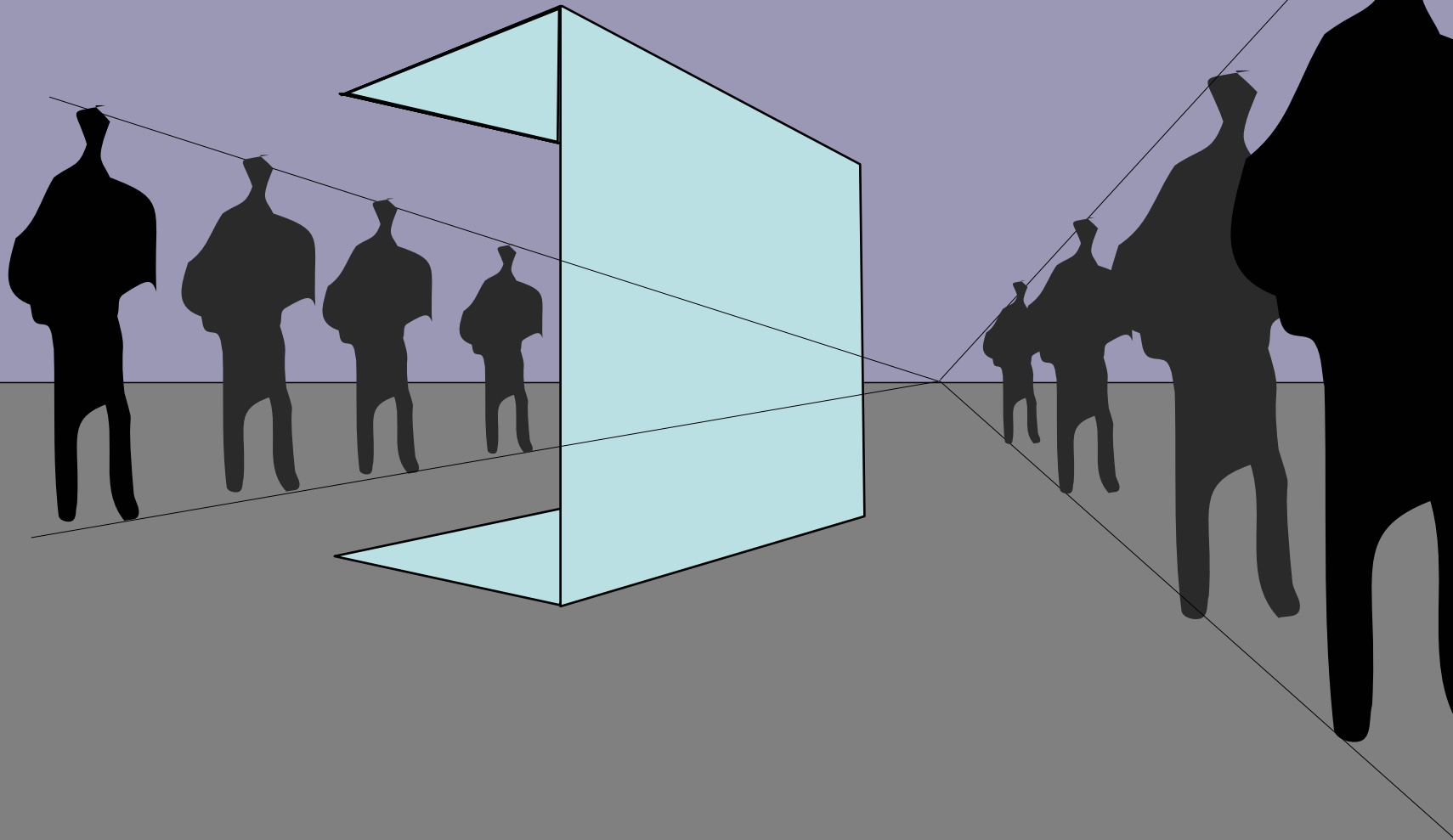

DIÉDRICO ORTOGONAL

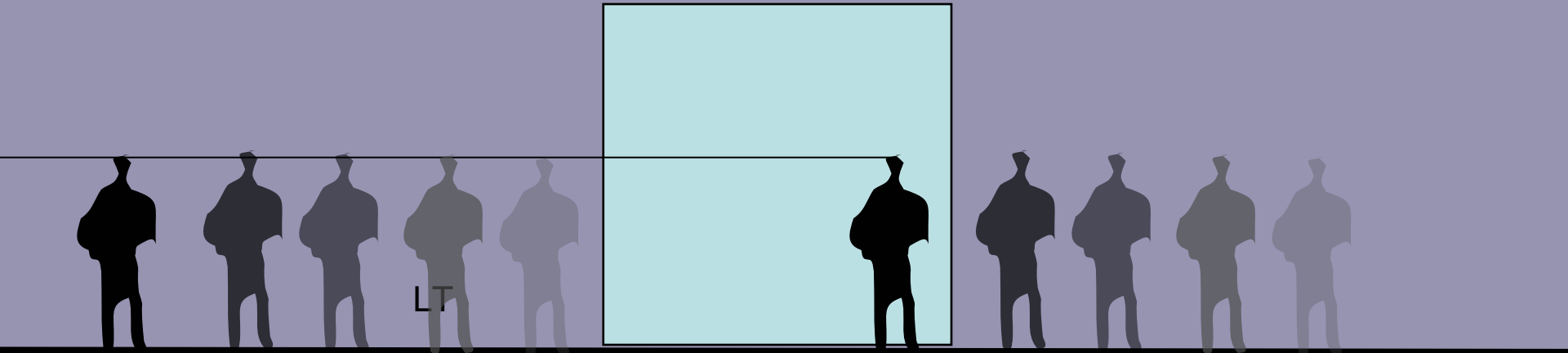

CORTE

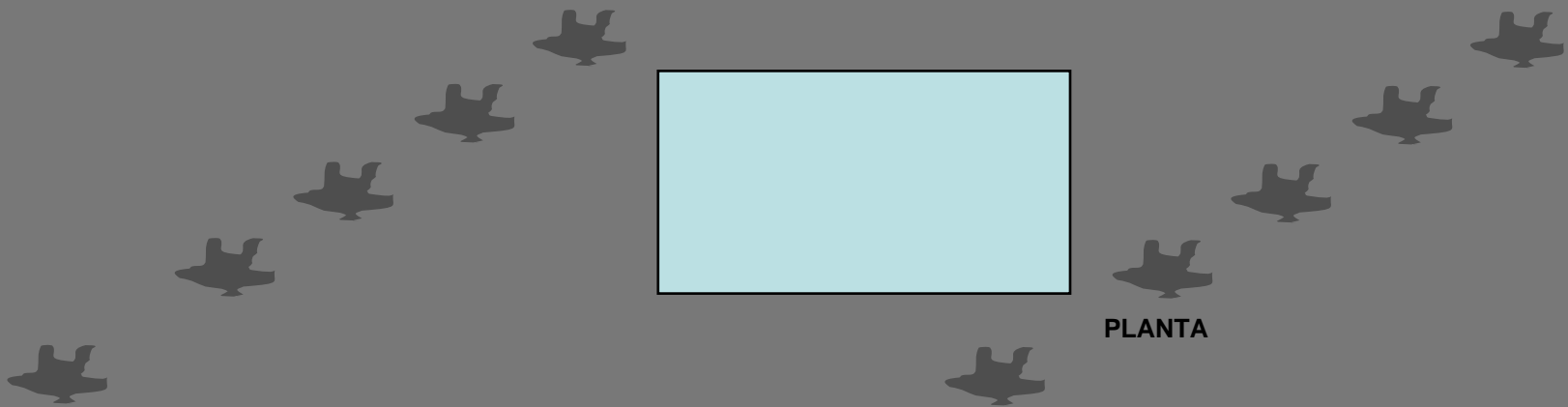

PLANTA

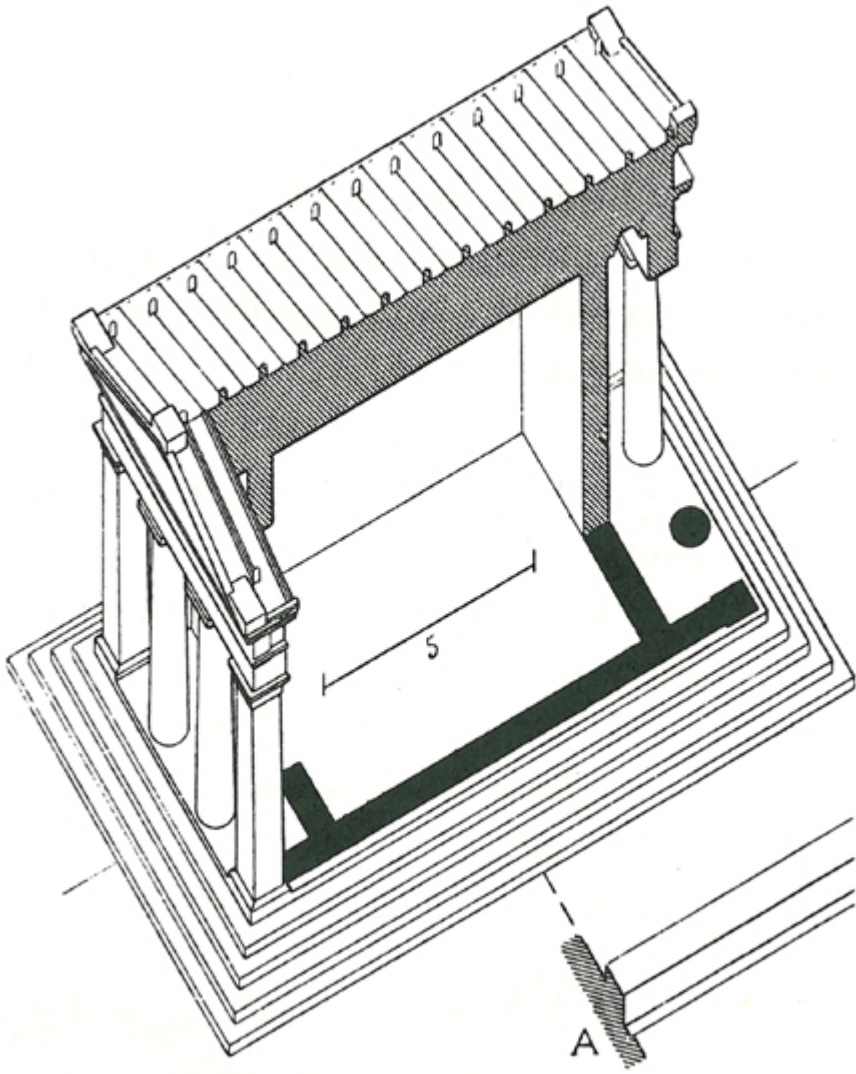

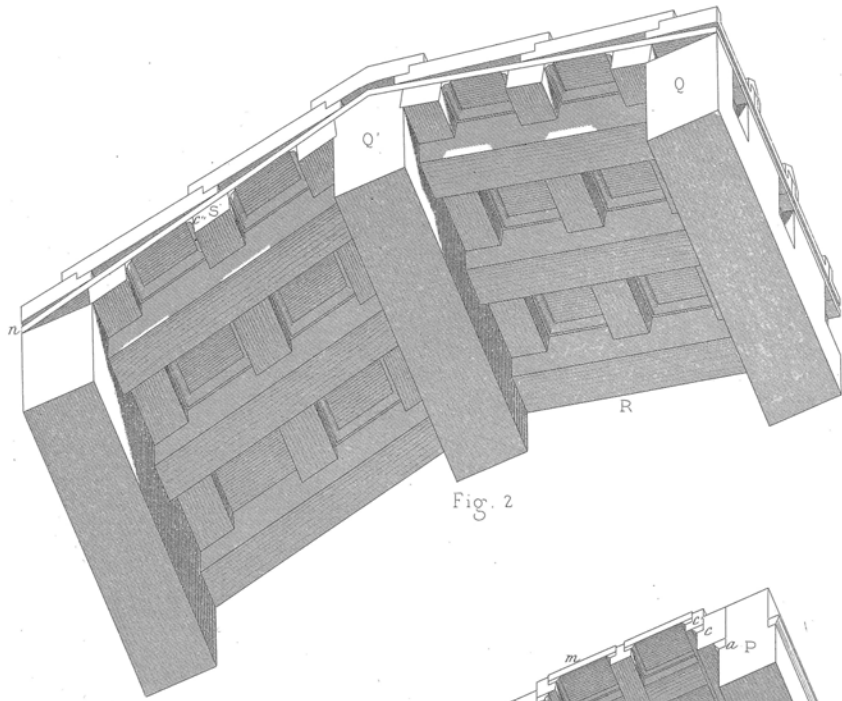

Fig. 2

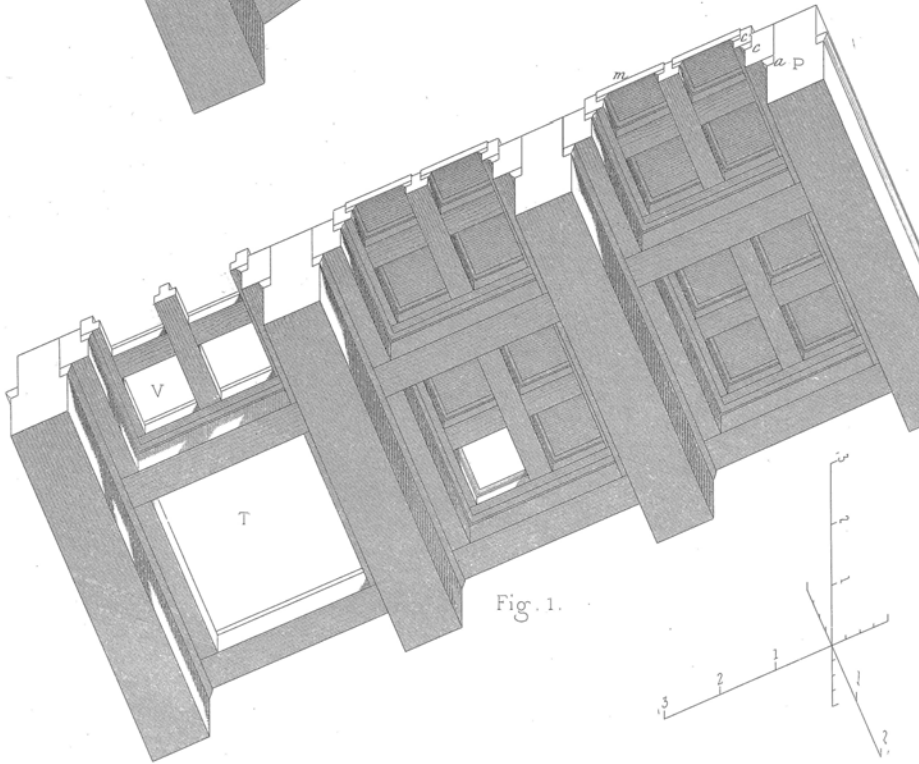
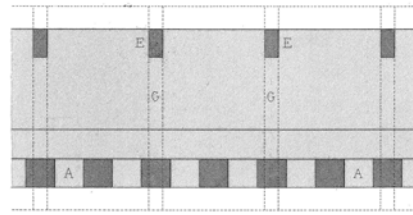
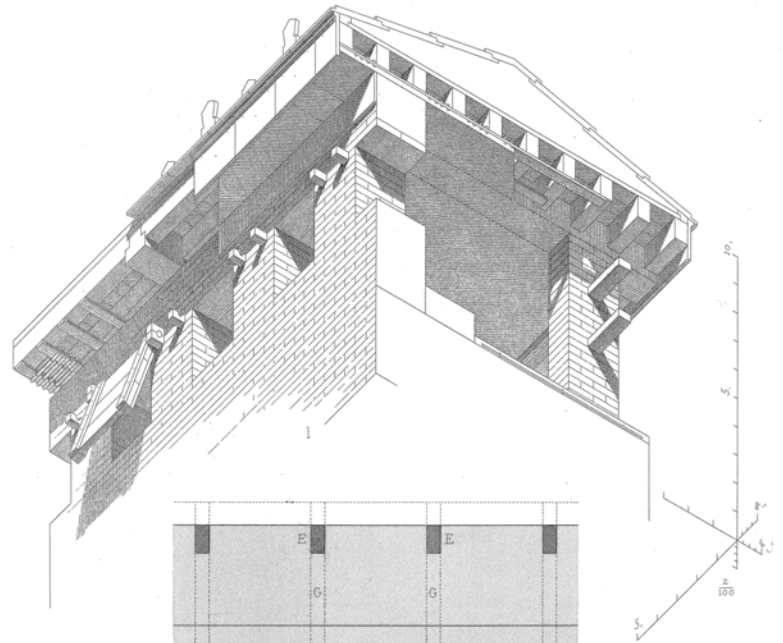
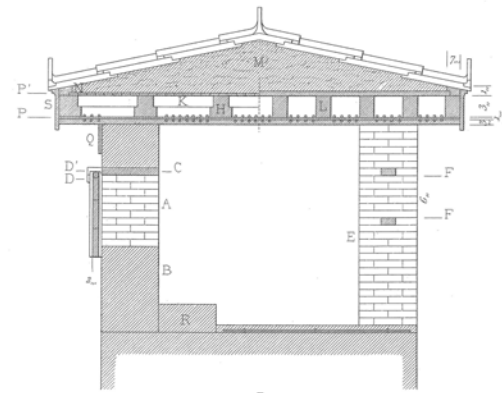

Fig. 1.



2



3

PROYECCIONES

PROYECCIONES PARALELAS (o cilíndricas)

PROYECCIONES PARALELAS ORTOGONALES

SISTEMA DIÉDRICO ORTOGONAL **SDO**

OBJETO

PROYECTANTES

CUADRO O PLANO DE REPRESENTACIÓN

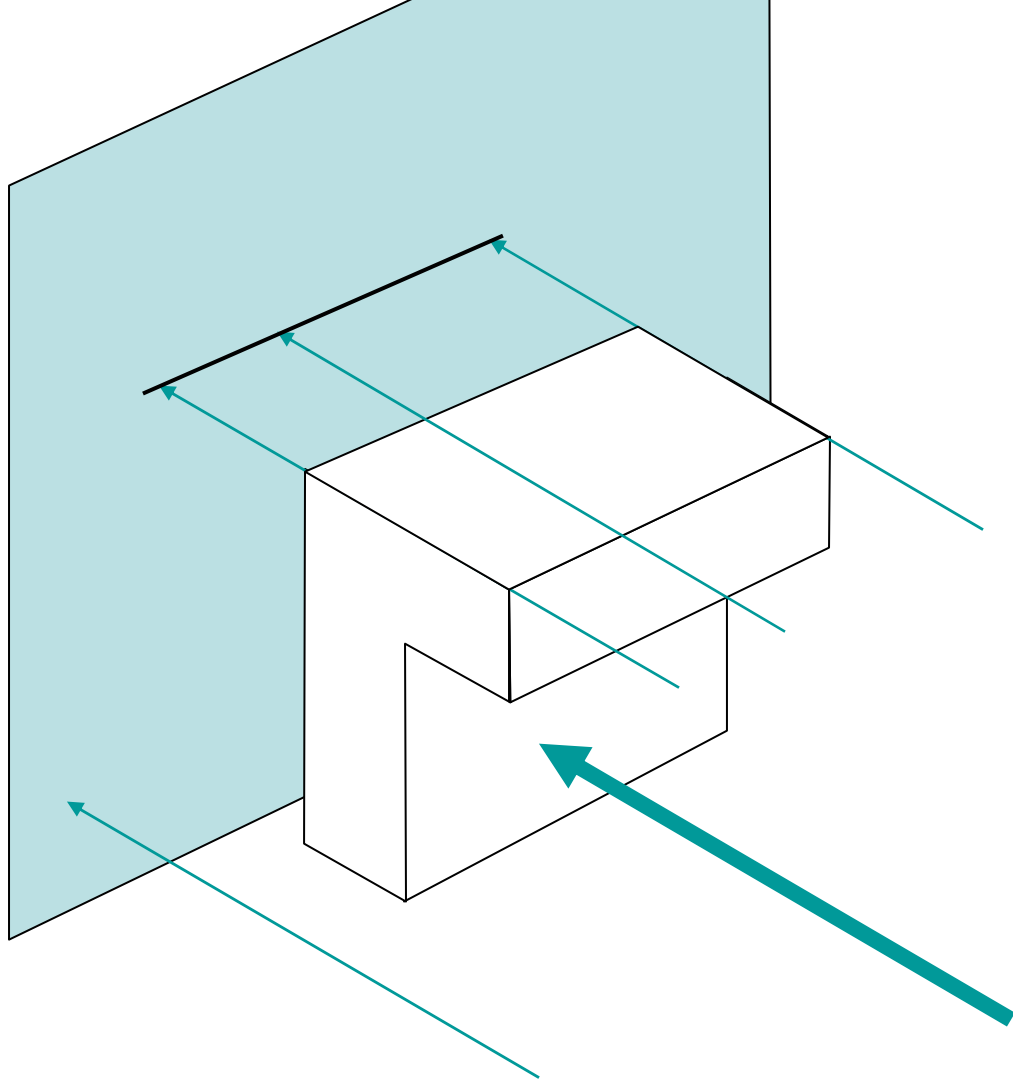

**PROYECCIONES PARALELAS
O CILÍNDRICAS**

**PROYECCIONES
ORTOGONALES**

**proyectantes
perpendiculares al plano
de representación...**

**cualquiera sea la
ubicación del objeto**

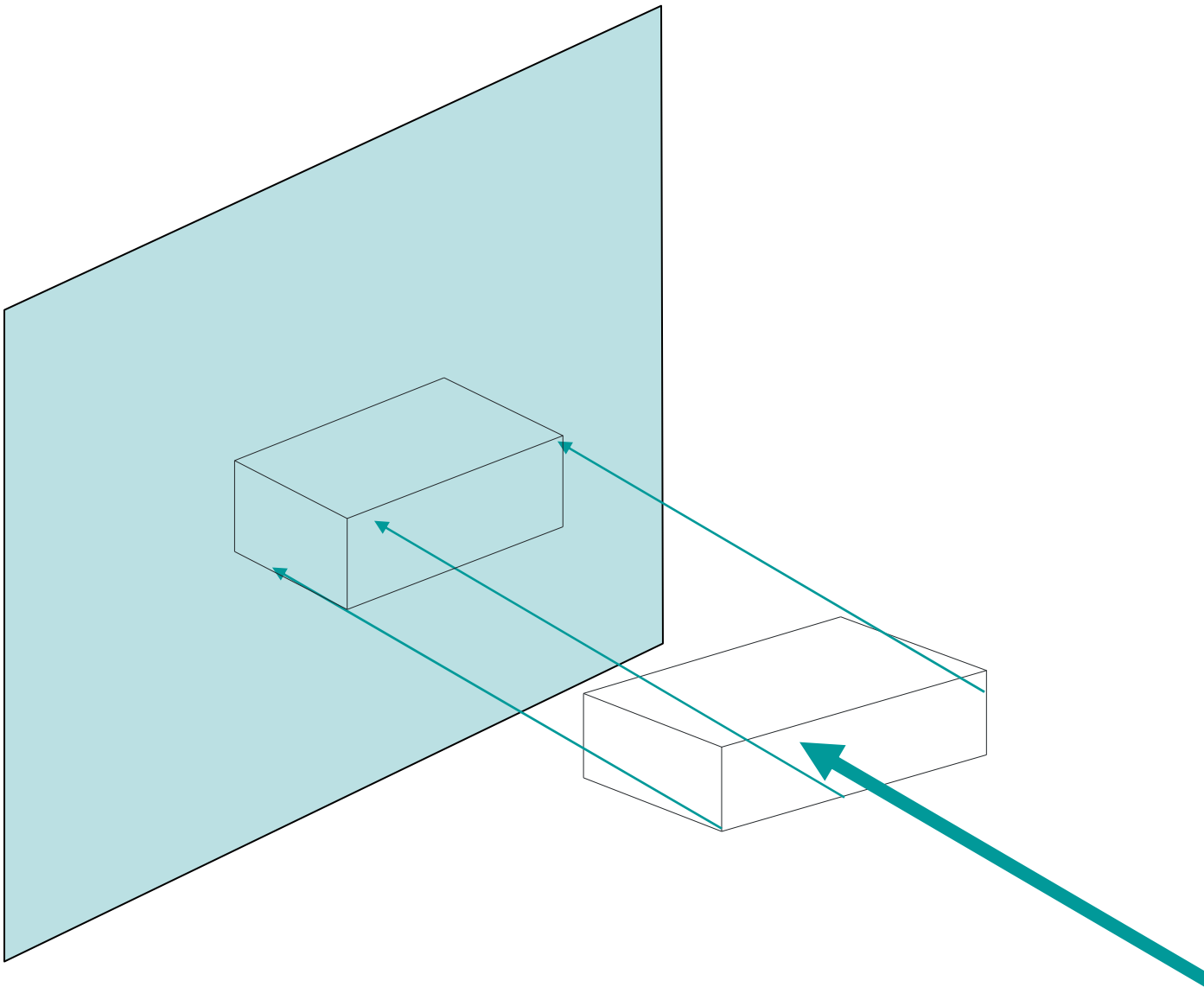

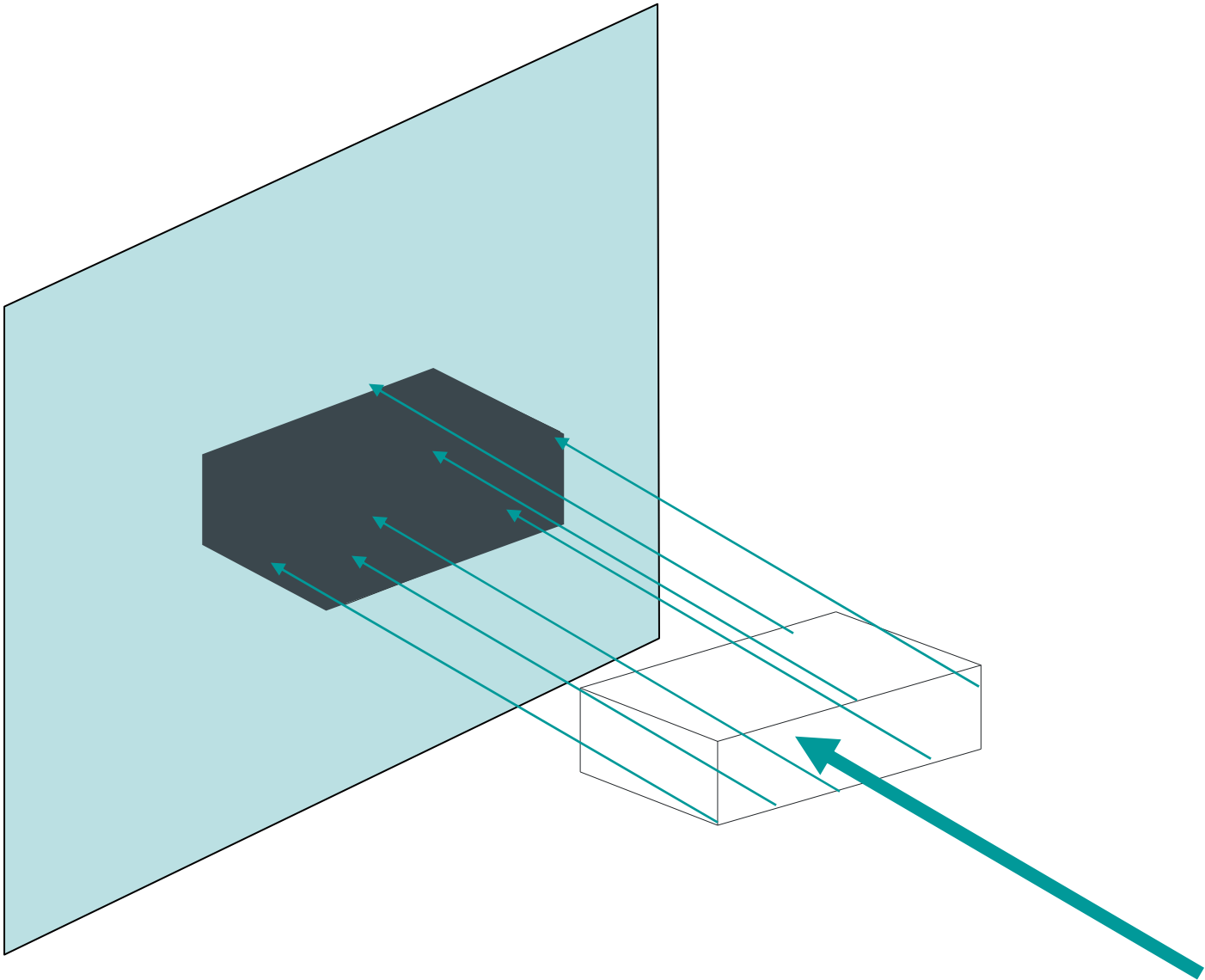

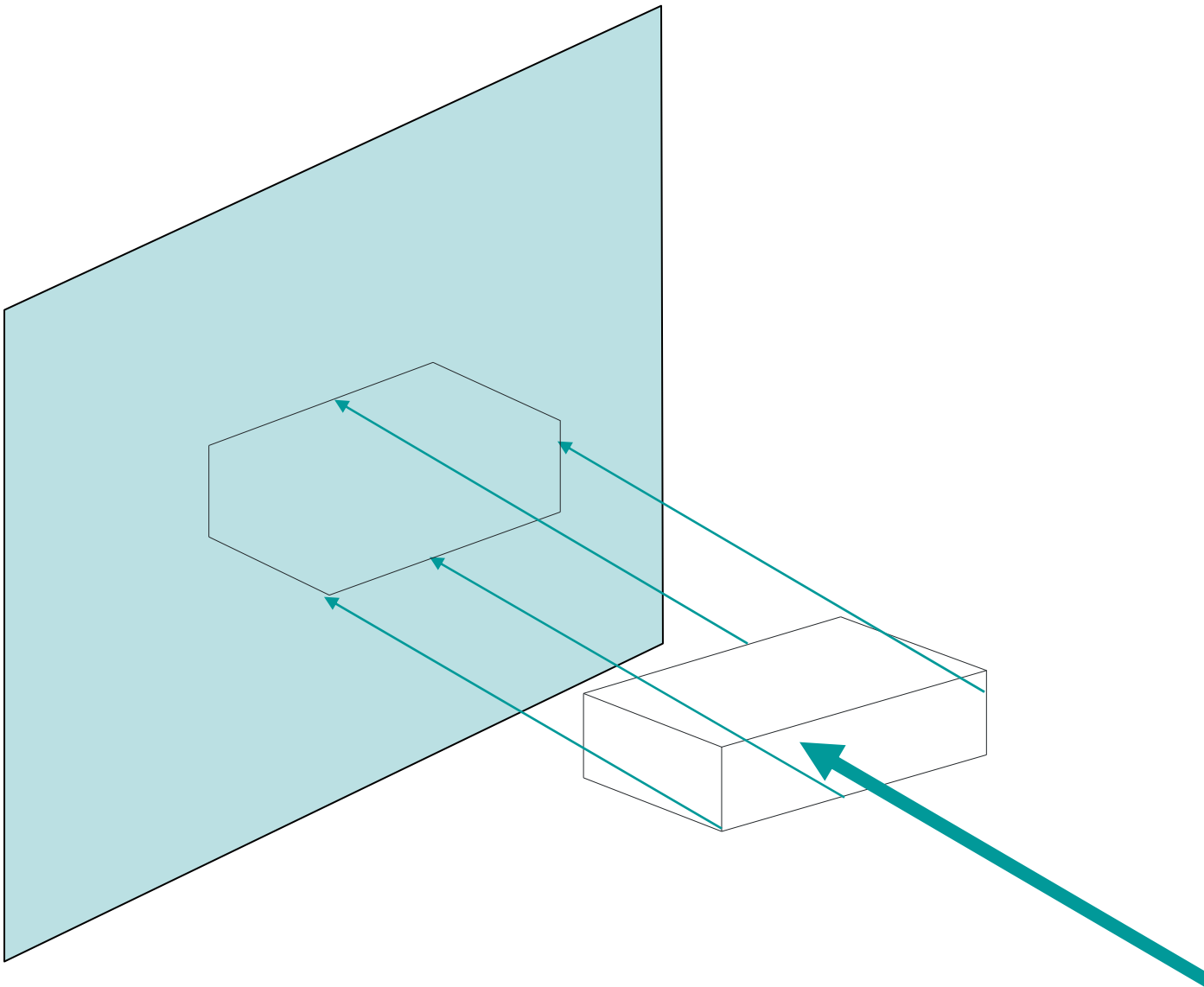

PERFIL – proyectantes tangentes al objeto

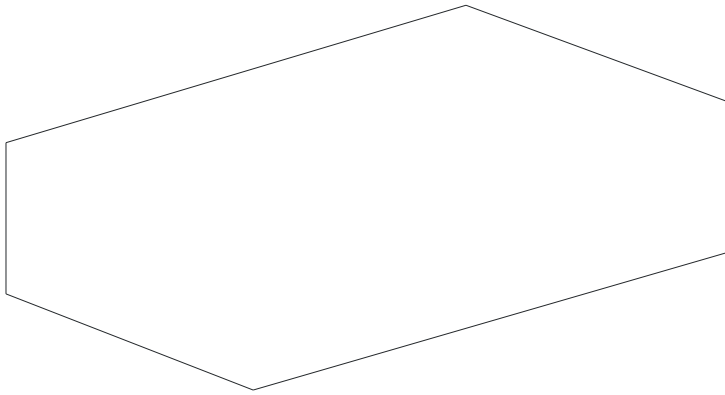

SILUETA – todas las proyectantes que pasan por el objeto

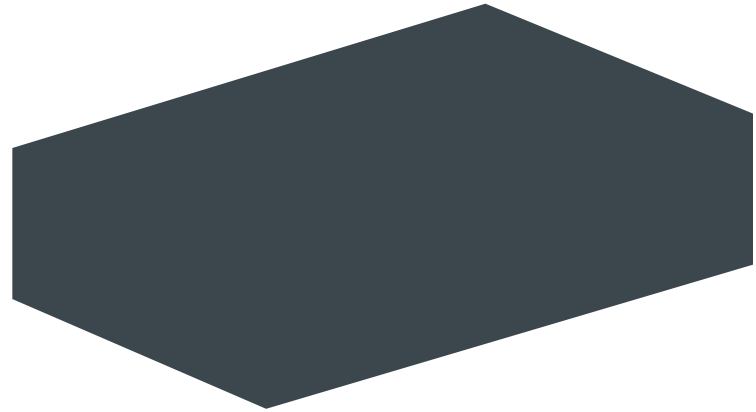

LINEAL - Aristas significativas

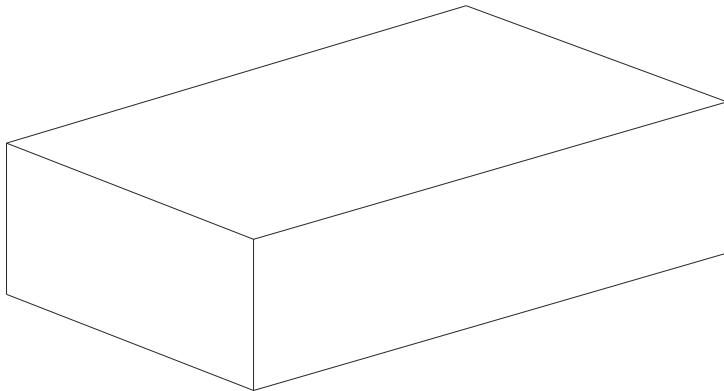

CLAROSCURO - Aristas significativas + luces y sombras

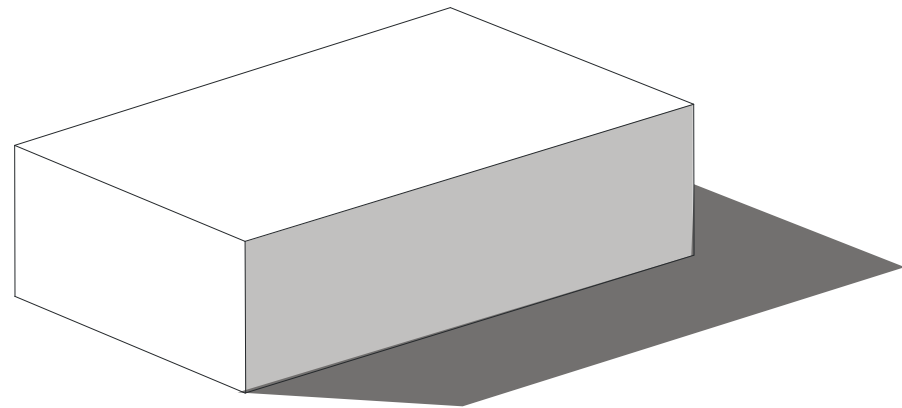

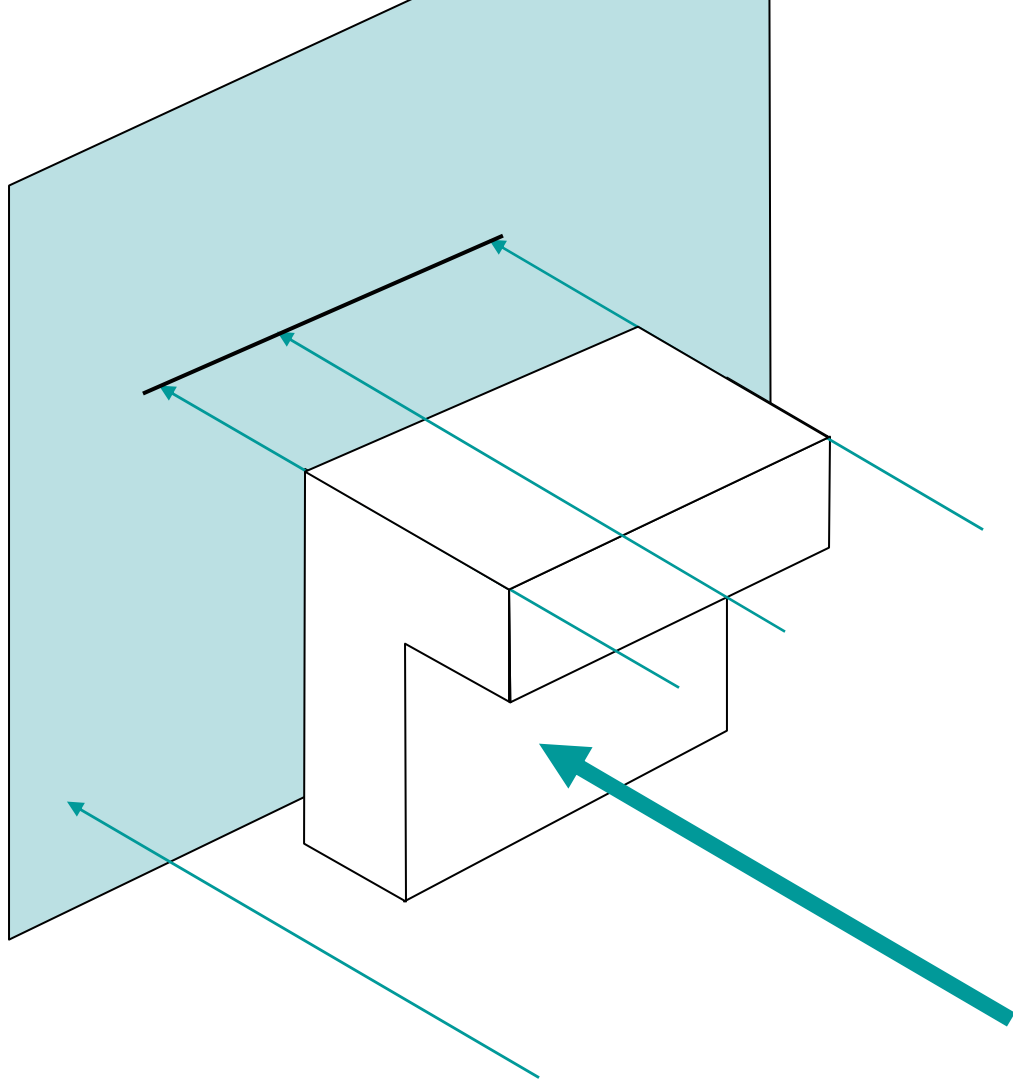

**PROYECCIONES PARALELAS
O CILÍNDRICAS**

**PROYECCIONES
ORTOGONALES**

**proyectantes
perpendiculares al plano
de representación...**

**cualquiera sea la
ubicación del objeto**

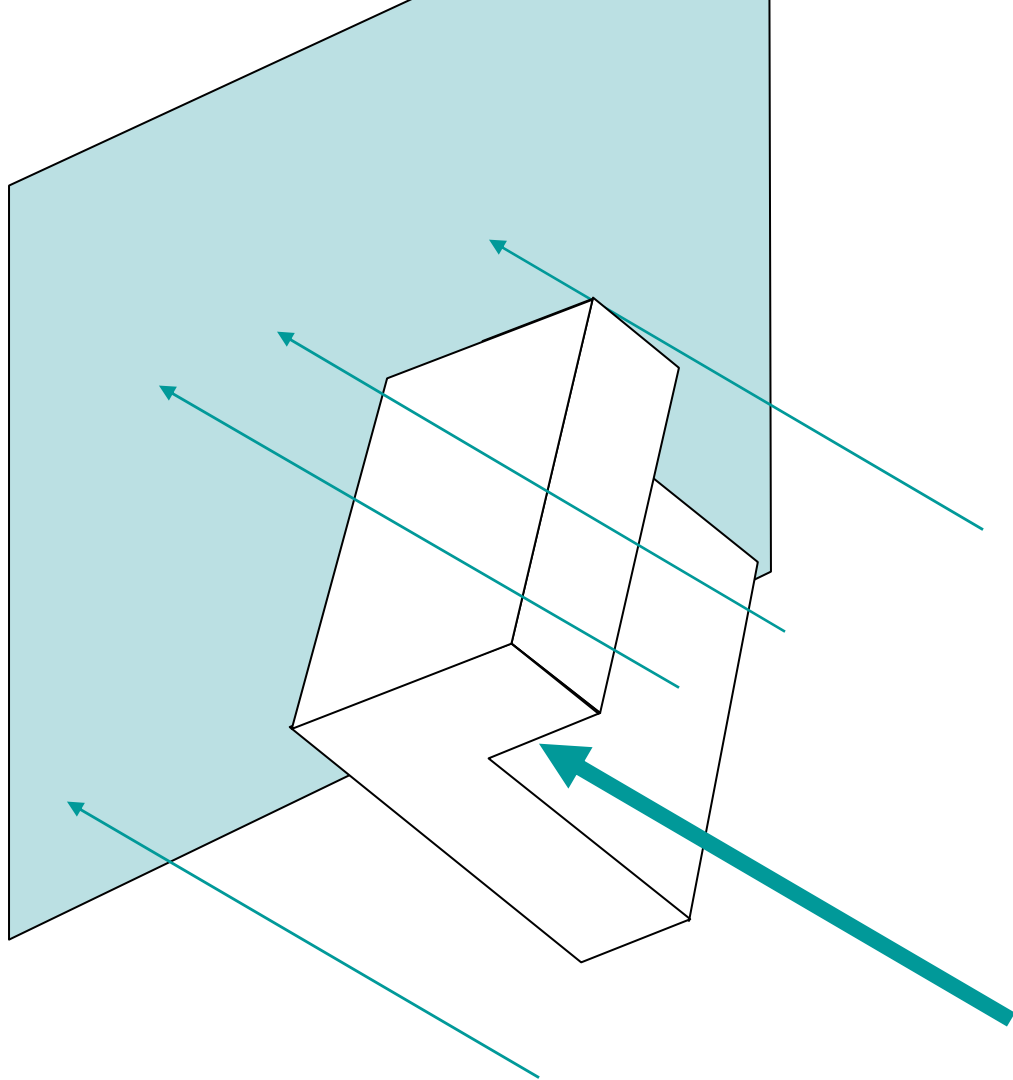

**PROYECCIONES PARALELAS
O CILÍNDRICAS**

**PROYECCIONES
ORTOGONALES**

proyectantes
perpendiculares al plano
de representación...

cualquiera sea la
ubicación del objeto

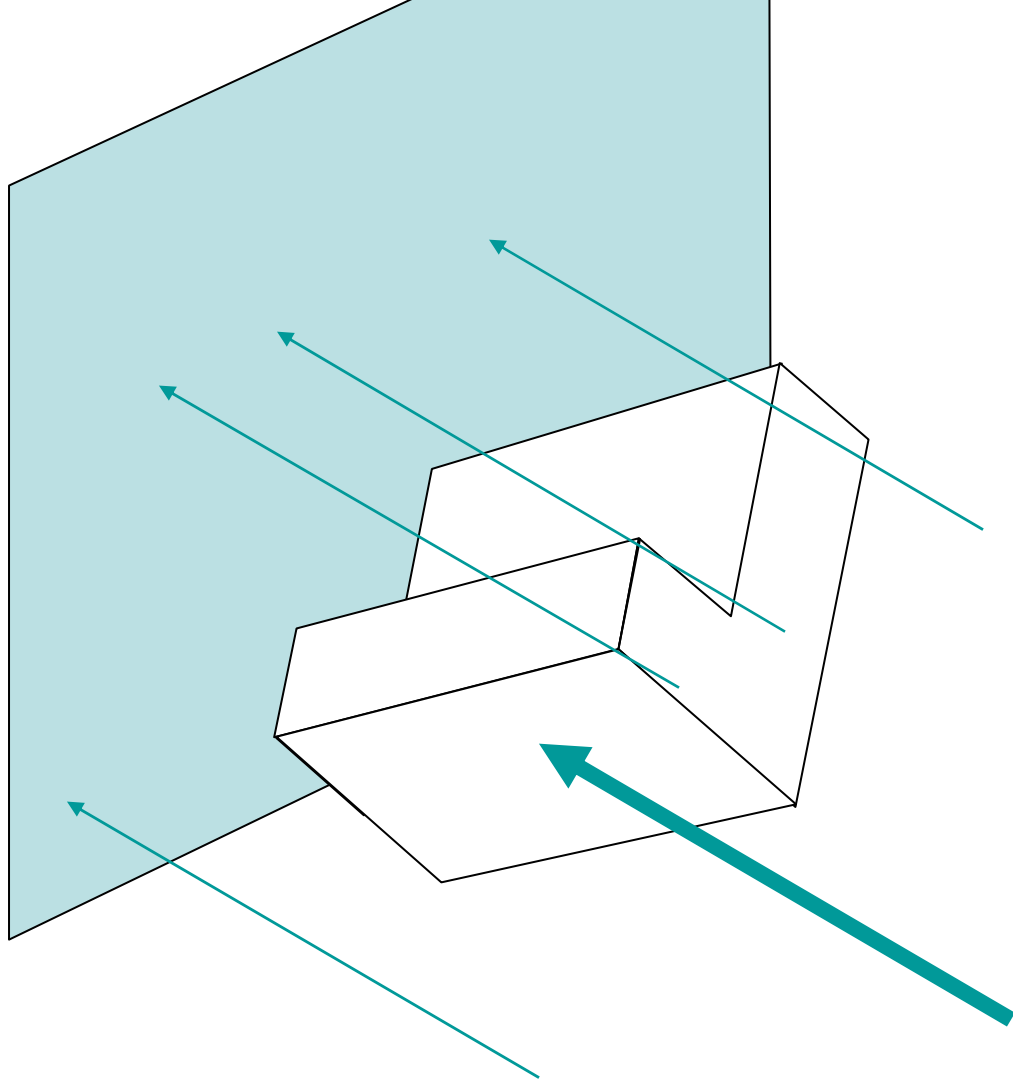

**PROYECCIONES PARALELAS
O CILÍNDRICAS**

**PROYECCIONES
ORTOGONALES**

**proyectantes
perpendiculares al plano
de representación...**

**cualquiera sea la
ubicación del objeto**

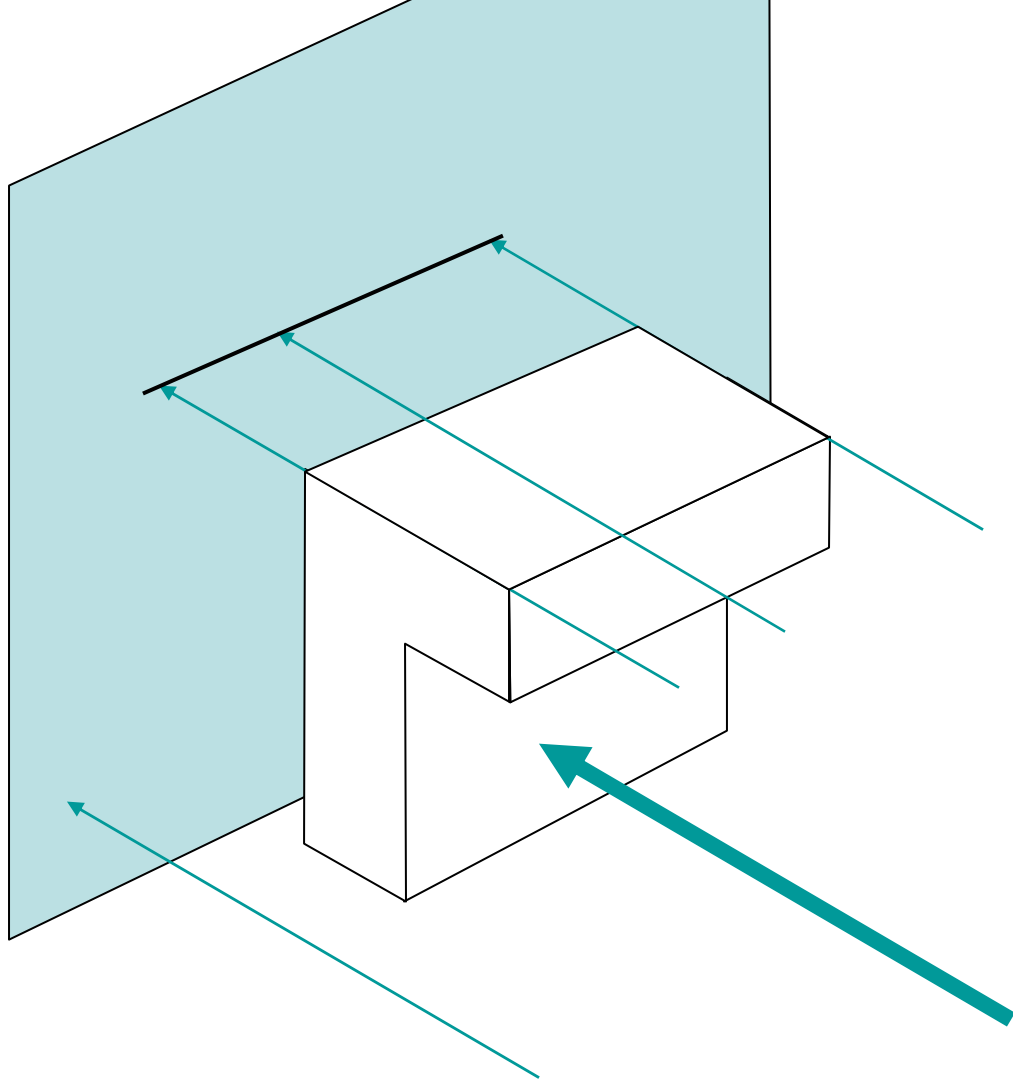

**PROYECCIONES PARALELAS
O CILÍNDRICAS**

**PROYECCIONES
ORTOGONALES**

**proyectantes
perpendiculares al plano
de representación...**

**cualquiera sea la
ubicación del objeto**

PROYECCIONES PARALELAS O CILÍNDRICAS

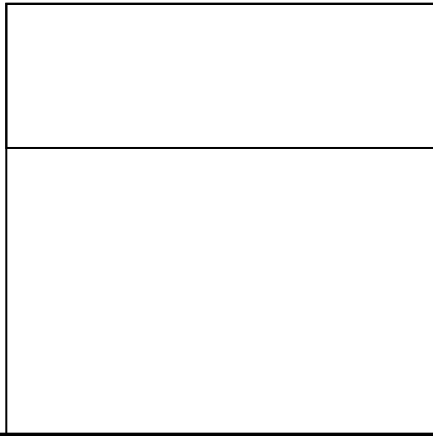

V''



LT

FACHADA

90°



V'

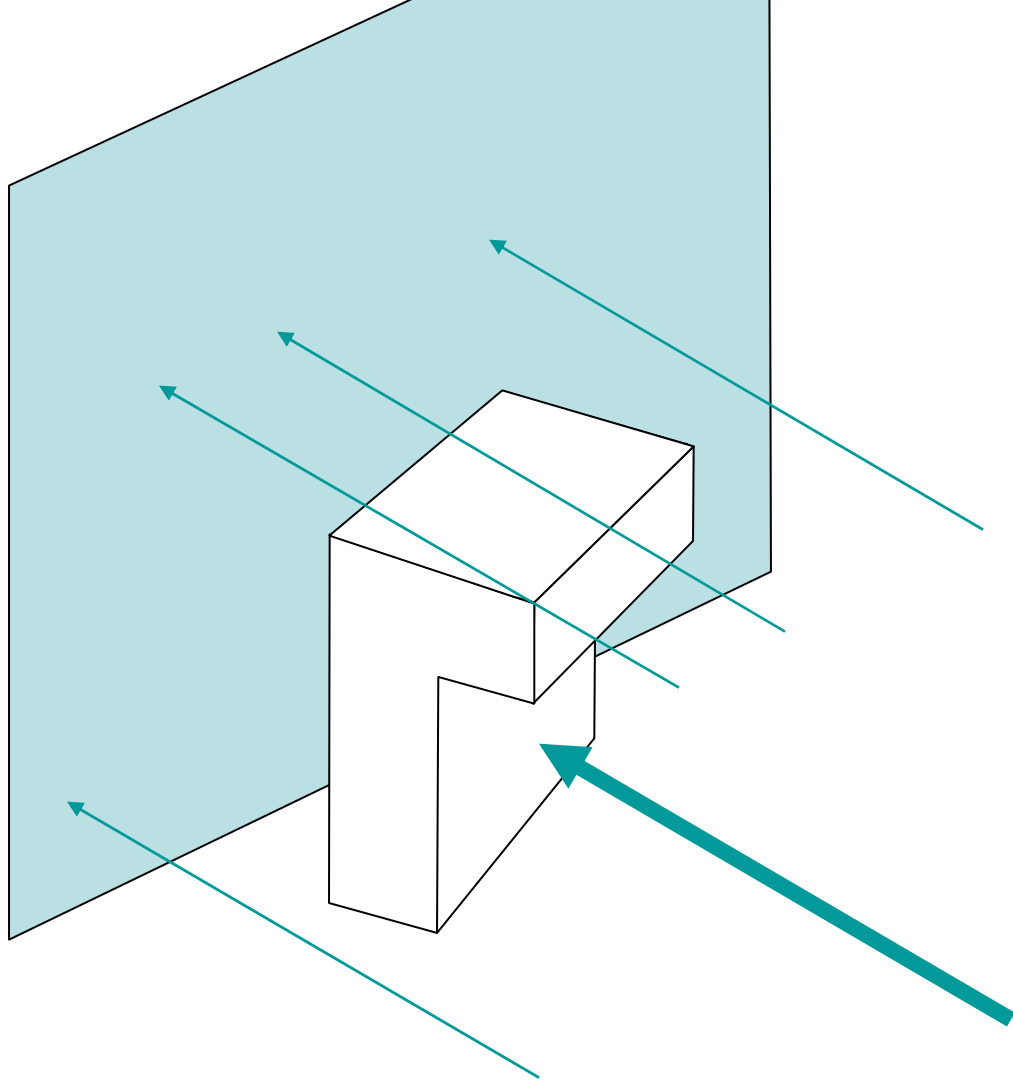

**PROYECCIONES PARALELAS
O CILÍNDRICAS**

**PROYECCIONES
ORTOGONALES**

**proyectantes
perpendiculares al plano
de representación...**

**cualquiera sea la
ubicación del objeto**

PROYECCIONES PARALELAS
O CILÍNDRICAS

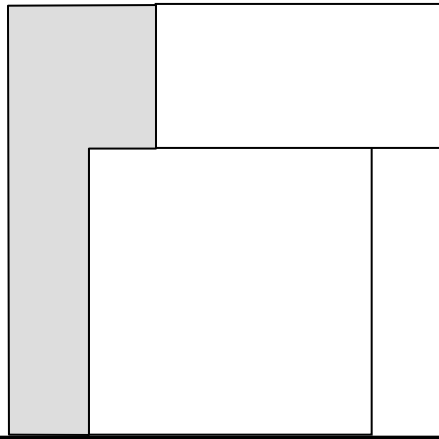

V''



LT

FACHADA



V'



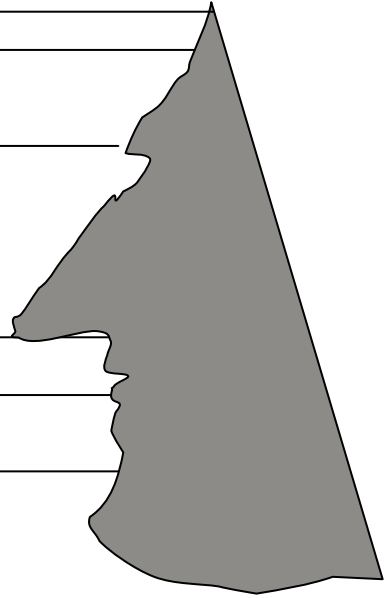

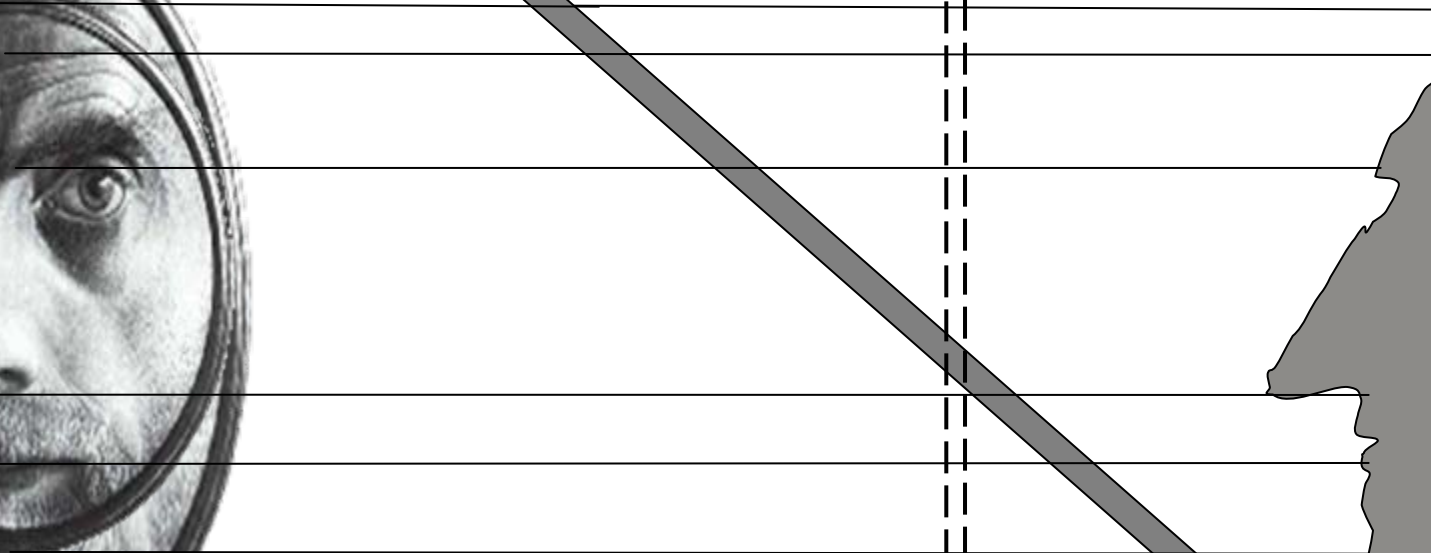
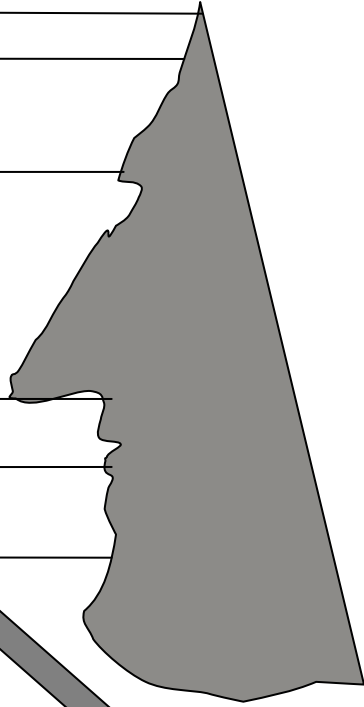
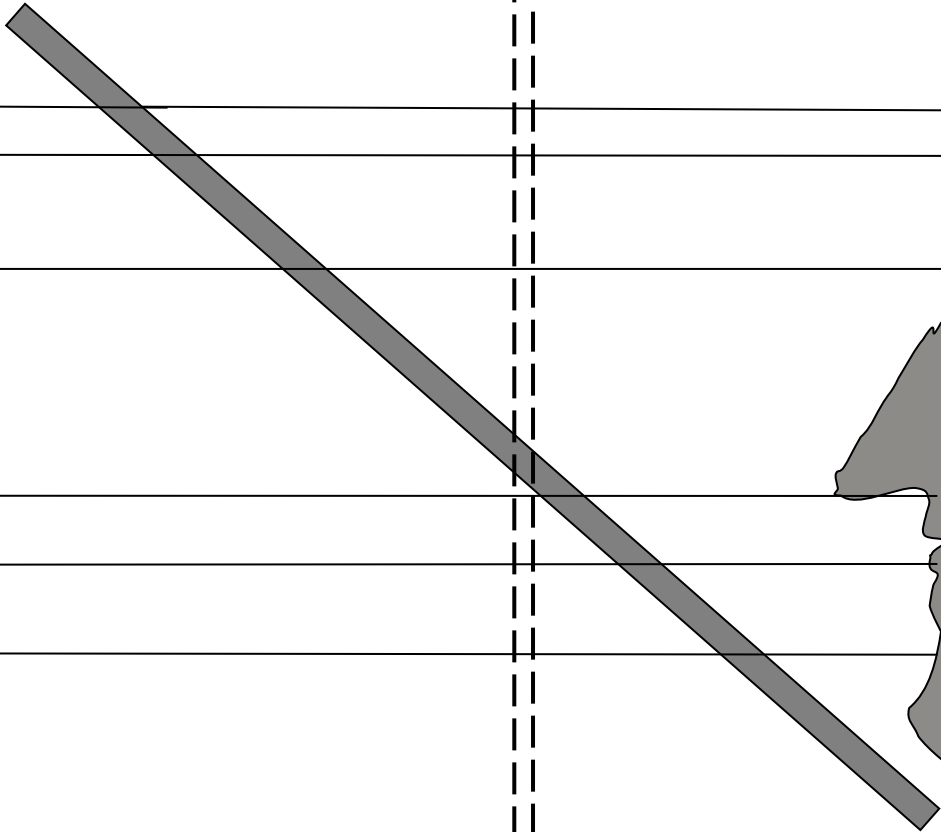



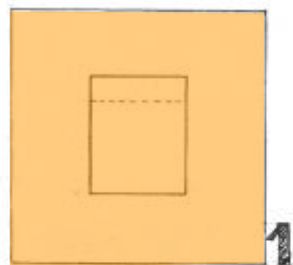
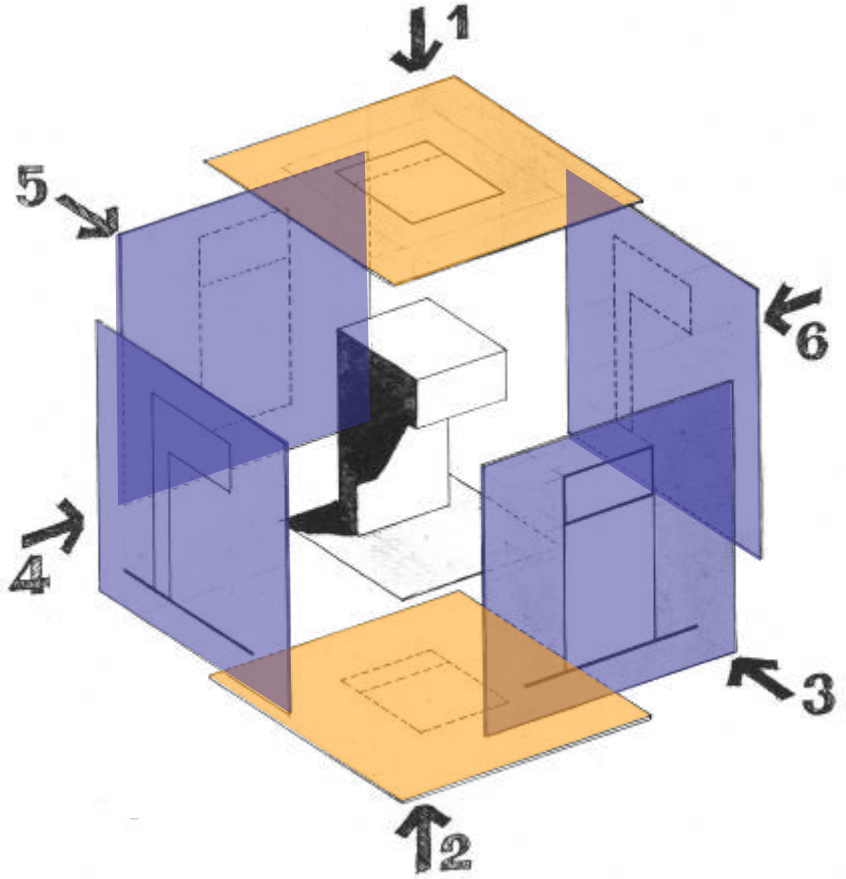

VISTA SUPERIOR-PLANTA

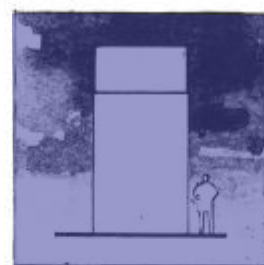

VISTA DE FRENTE

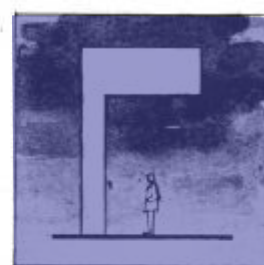

VISTA LATERAL

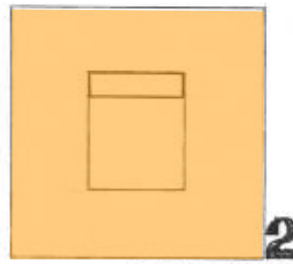

VISTA INFERIOR



VISTA POSTERIOR

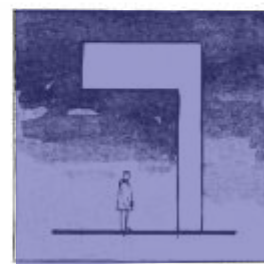

VISTA LATERAL

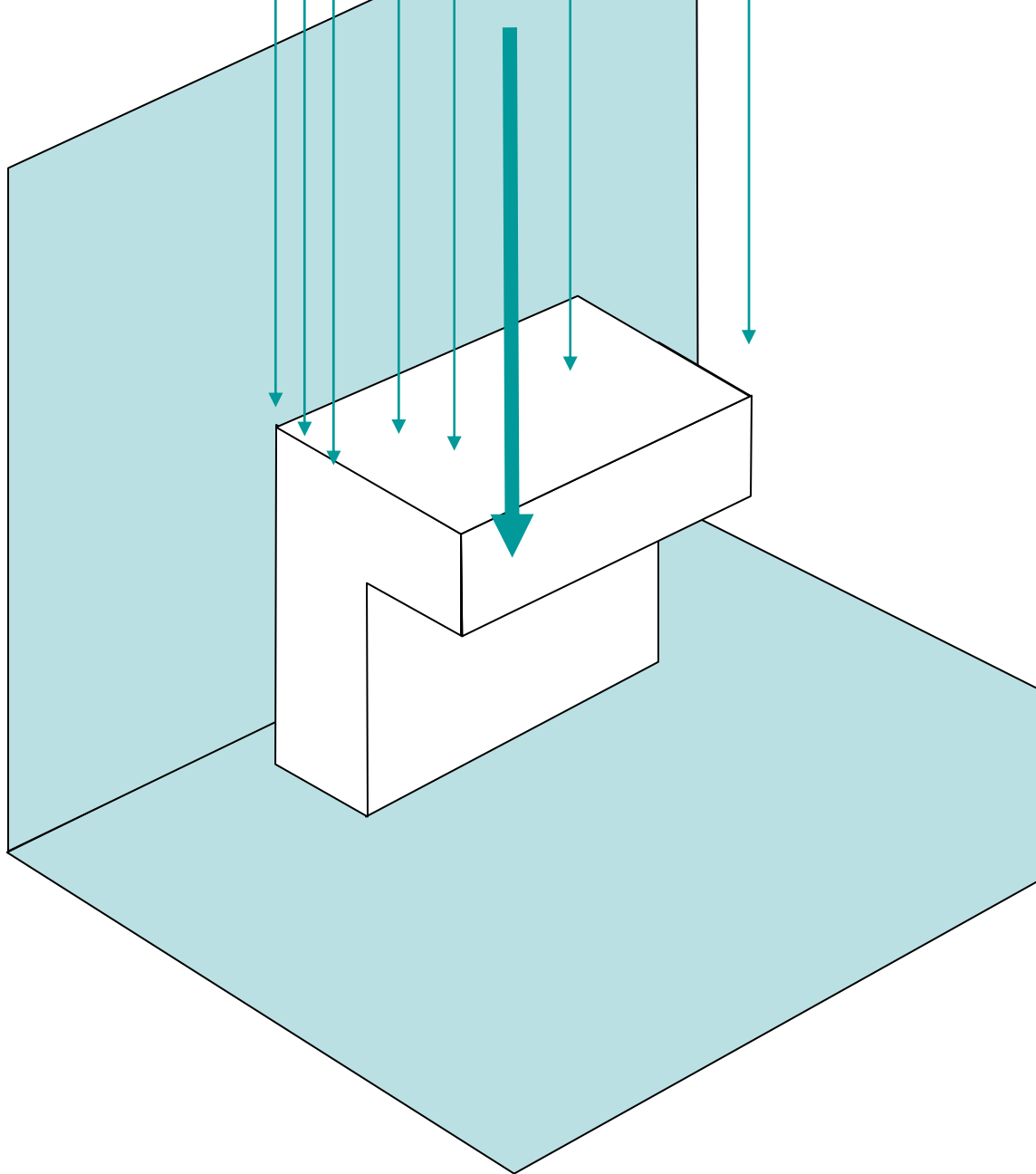

**PROYECCIONES PARALELAS
O CILÍNDRICAS**

**PROYECCIONES
ORTOGONALES**

**proyectantes
perpendiculares al plano
de representación...**

**cualquiera sea la
ubicación del objeto**

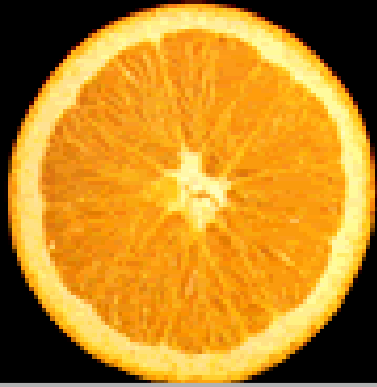

LT

CORTE 1

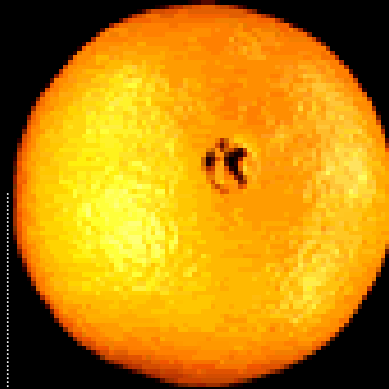

FACHADA

1

1

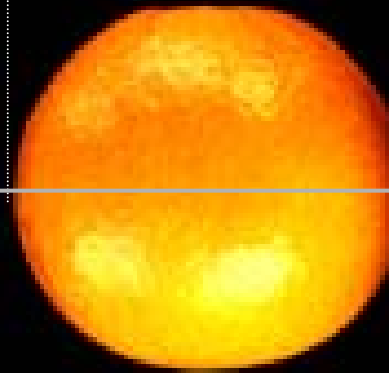

PLANTA TECHOS

A



B



C



LT

CORTE 1

1

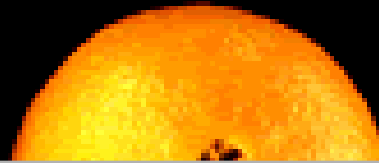

1

PLANTA TECHOS

B

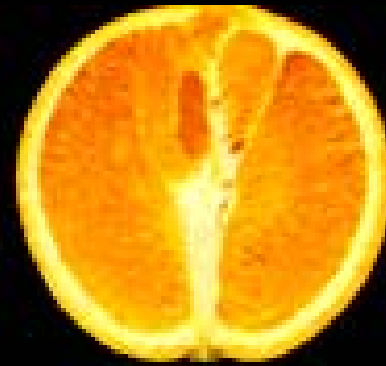

CORTE 1

LT

1

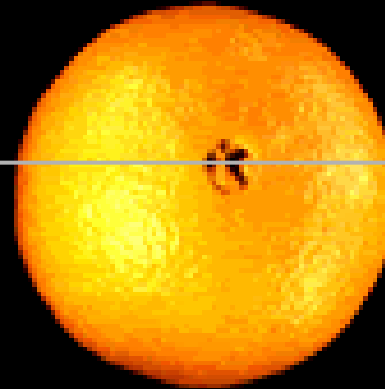

1

PLANTA TECHOS

LT



FACHADA

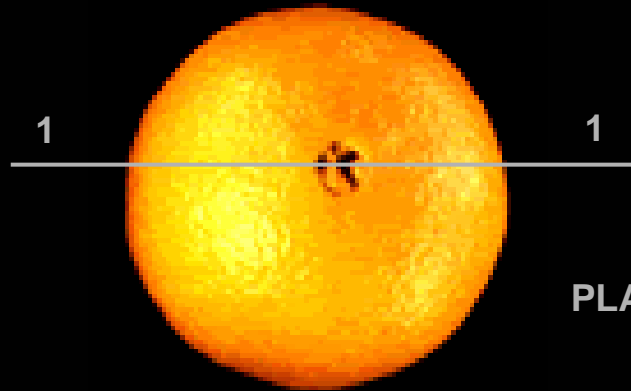

PLANTA TECHOS

LT



CAJETA

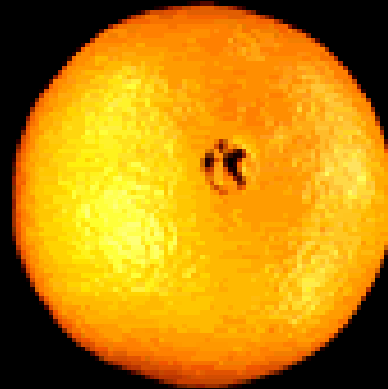

PLANTA TECHOS

1

1



1



2

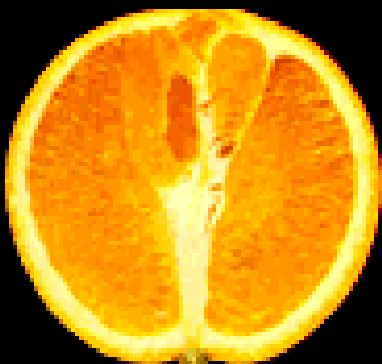

3



2

LT

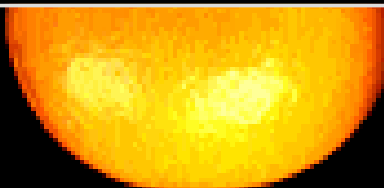

2

FACHADA

PLANTA TECHOS

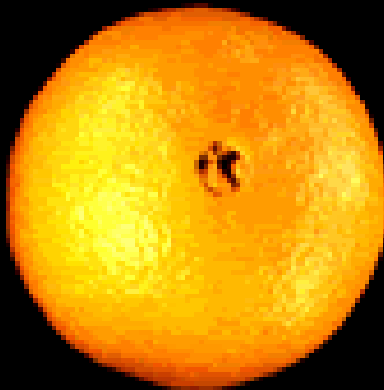

LT

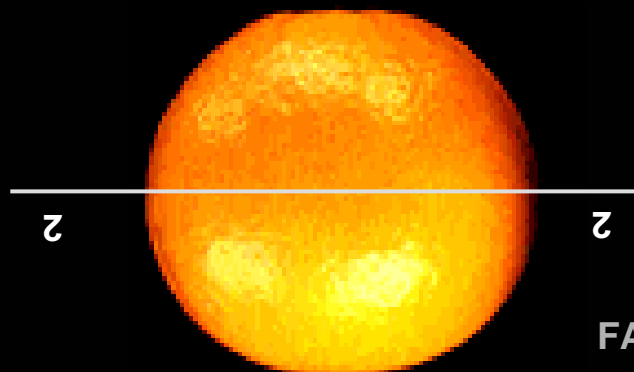

FACHADA

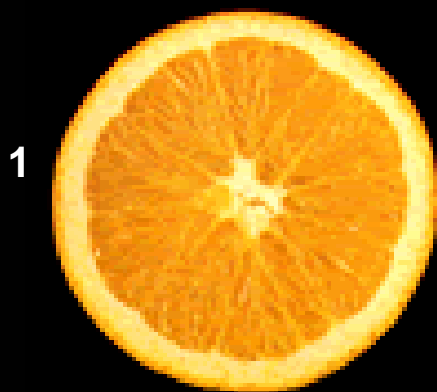

1

PLANTA
CORTE 2

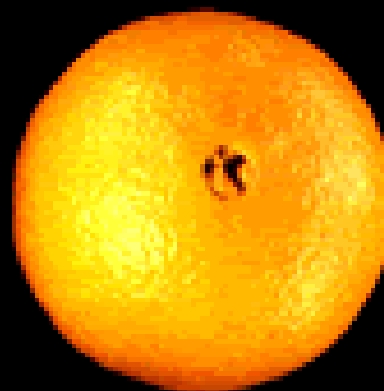

PLANTA
TECHOS

LT

2

2

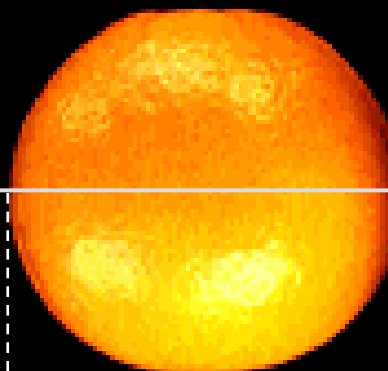

FACHADA

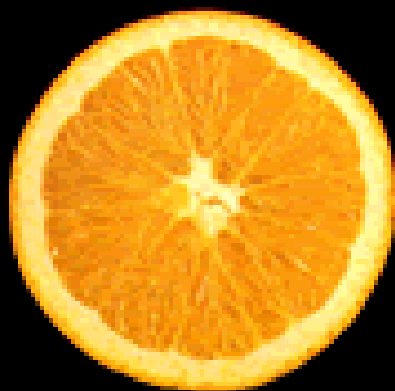

PLANTA
CORTE 2

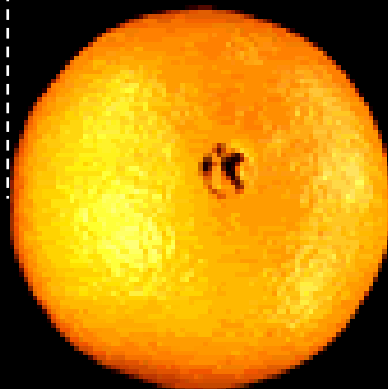

PLANTA TECHOS

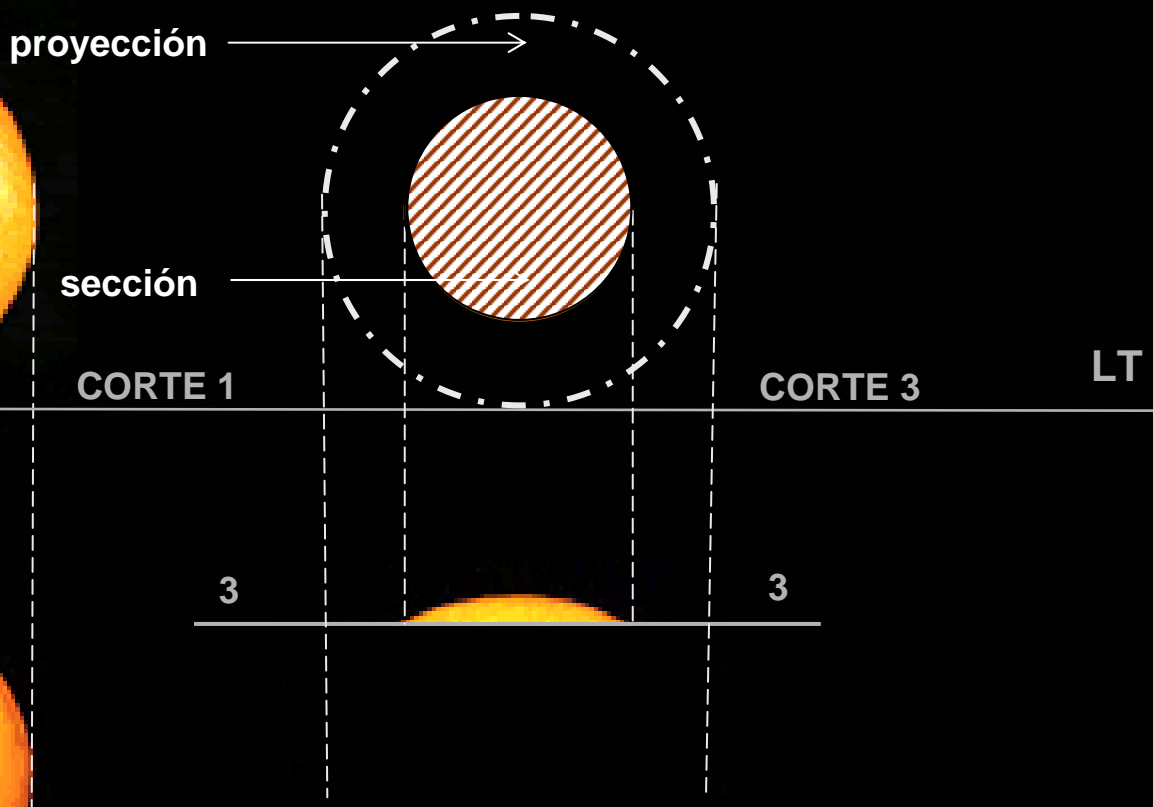
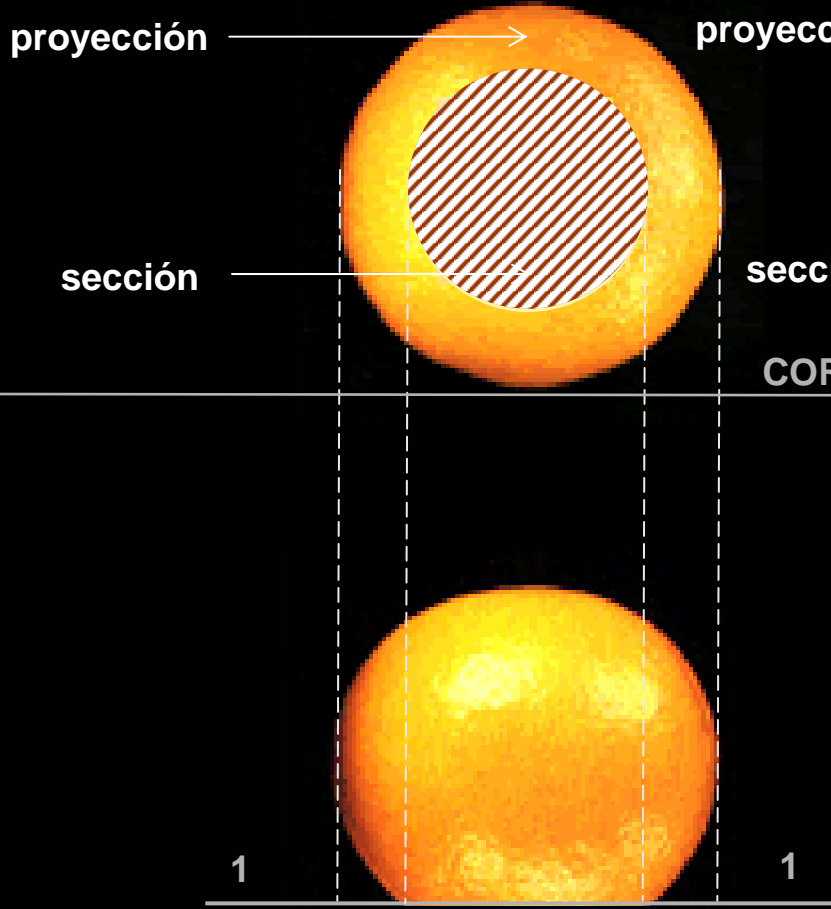

PLANTA TECHOS

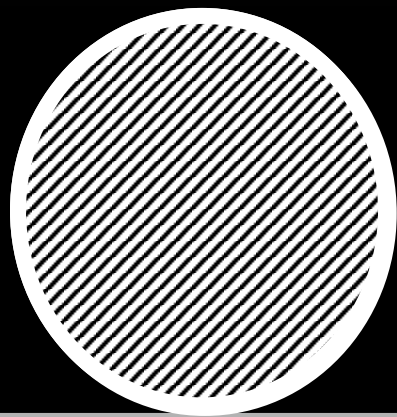

LT

CORTE 1

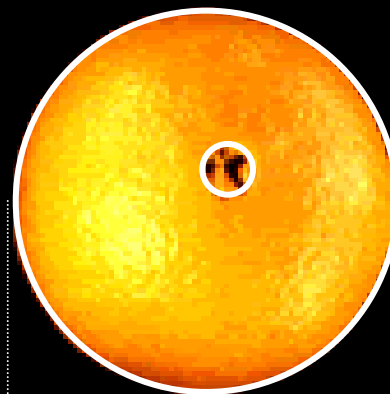

FACHADA

1

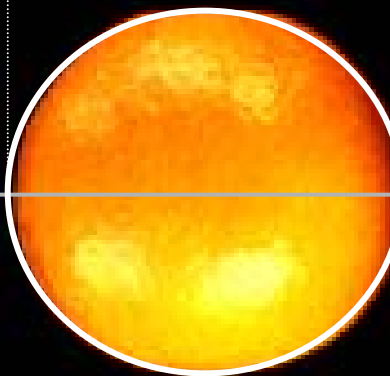

1

PLANTA TECHOS

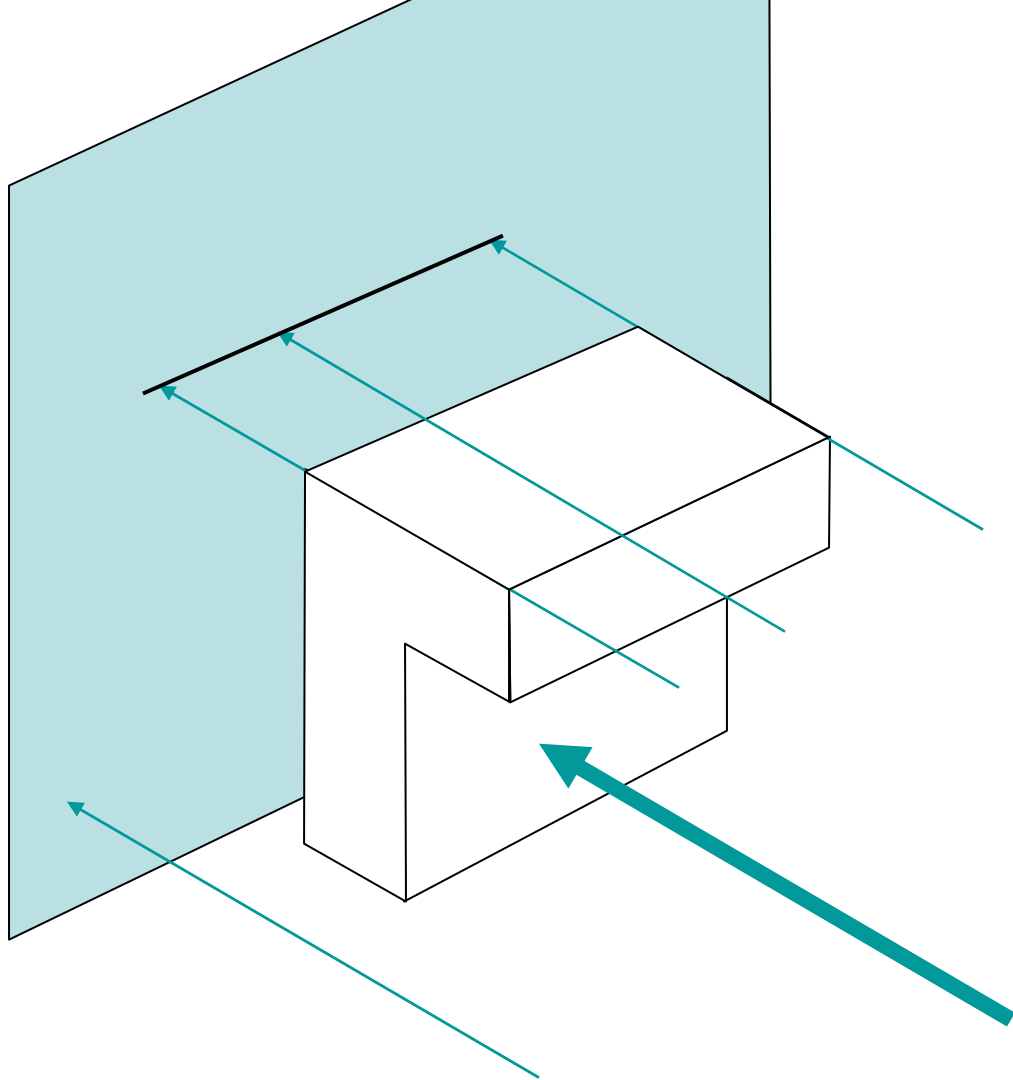

**PROYECCIONES PARALELAS
O CILÍNDRICAS**

**PROYECCIONES
ORTOGONALES**

**proyectantes
perpendiculares al plano
de representación...**

**cualquiera sea la
ubicación del objeto**

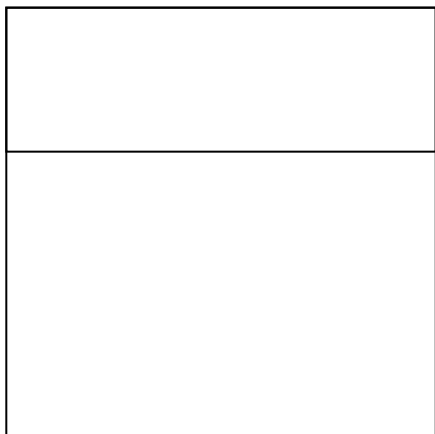

LT

FACHADA

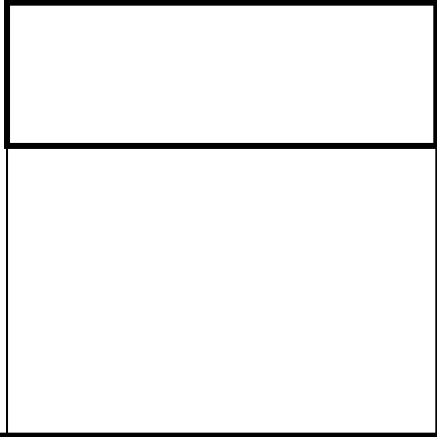

LT

FACHADA + TRAZO VALORADO

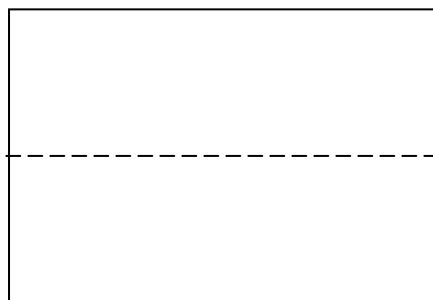
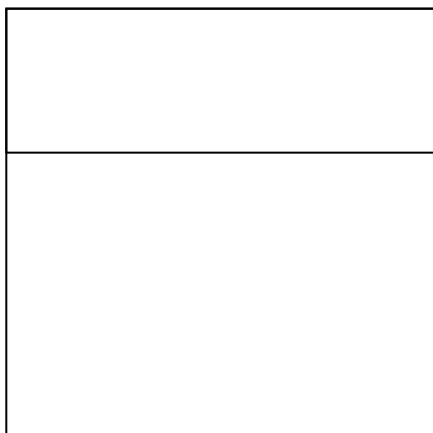

LT

FACHADA + PLANTA TECHOS

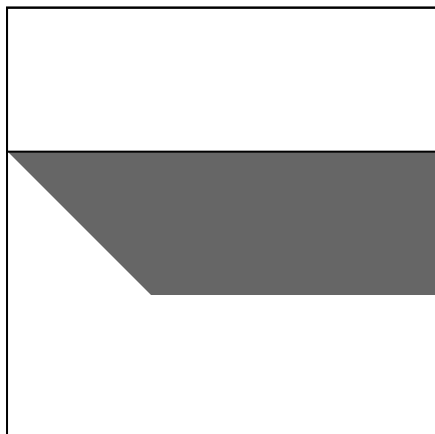

LT

FACHADA + SOMBRA

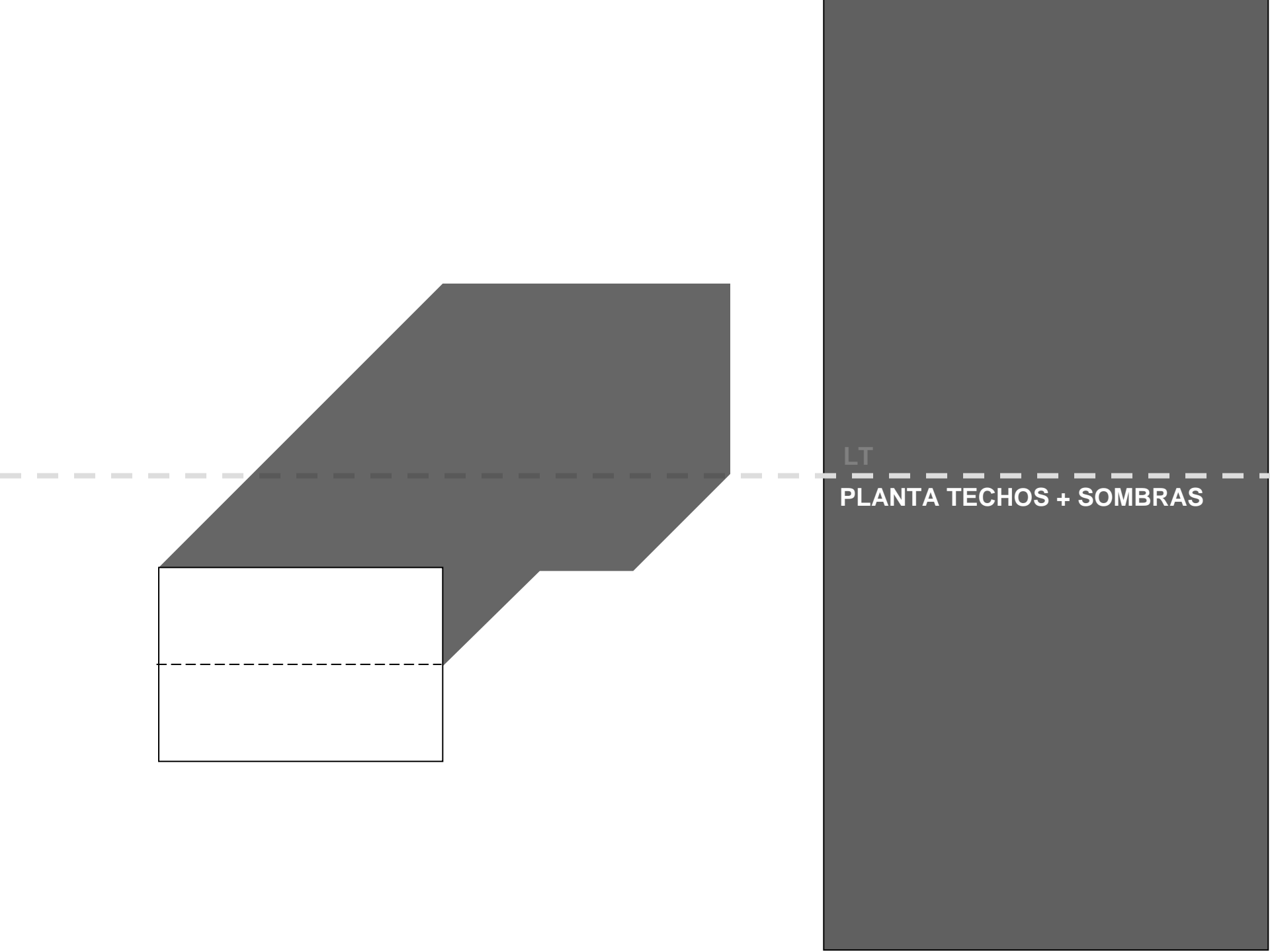

LT

PLANTA TECHOS + SOMBRAS

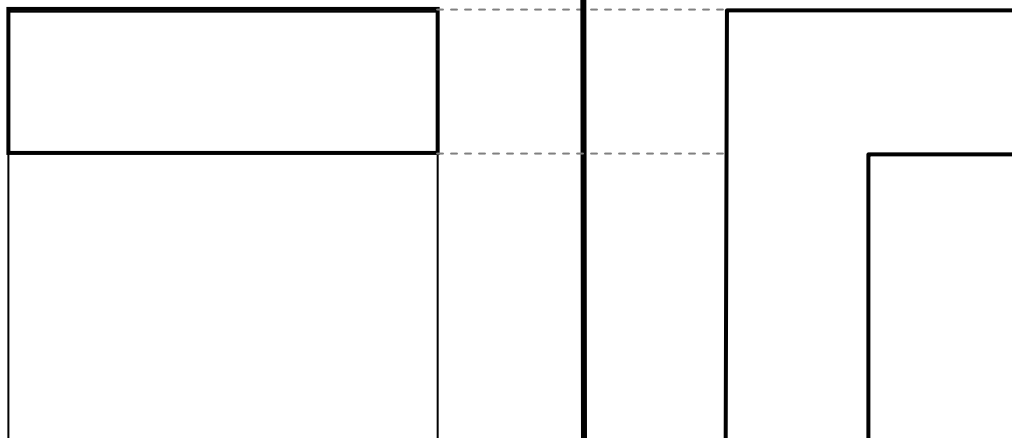

LT

FACHADA FRONTAL

+ PLANTA TECHOS

+ FACHADA LATERAL

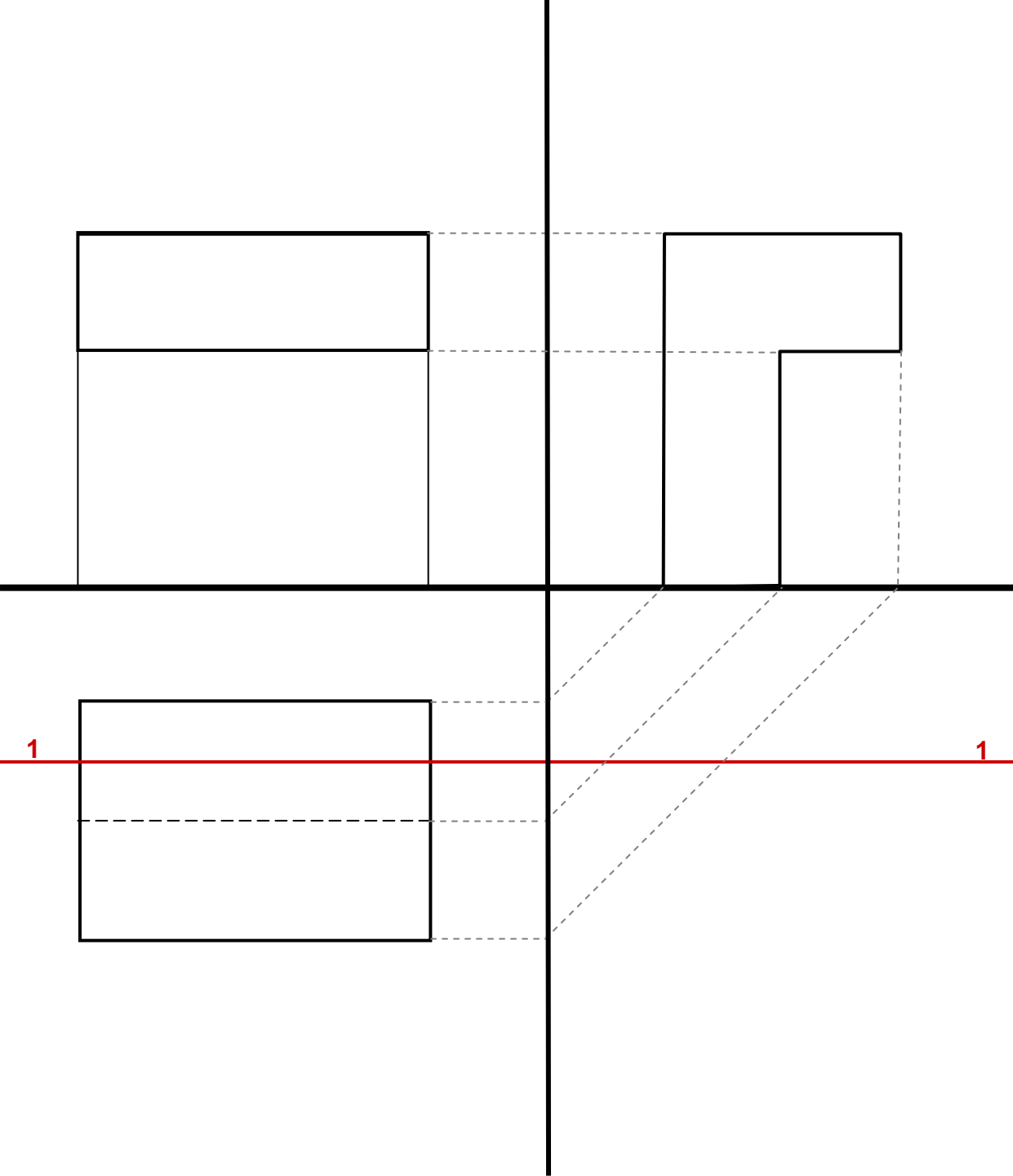

LT

FACHADA FRONTAL

+ PLANTA TECHOS

+ FACHADA LATERAL

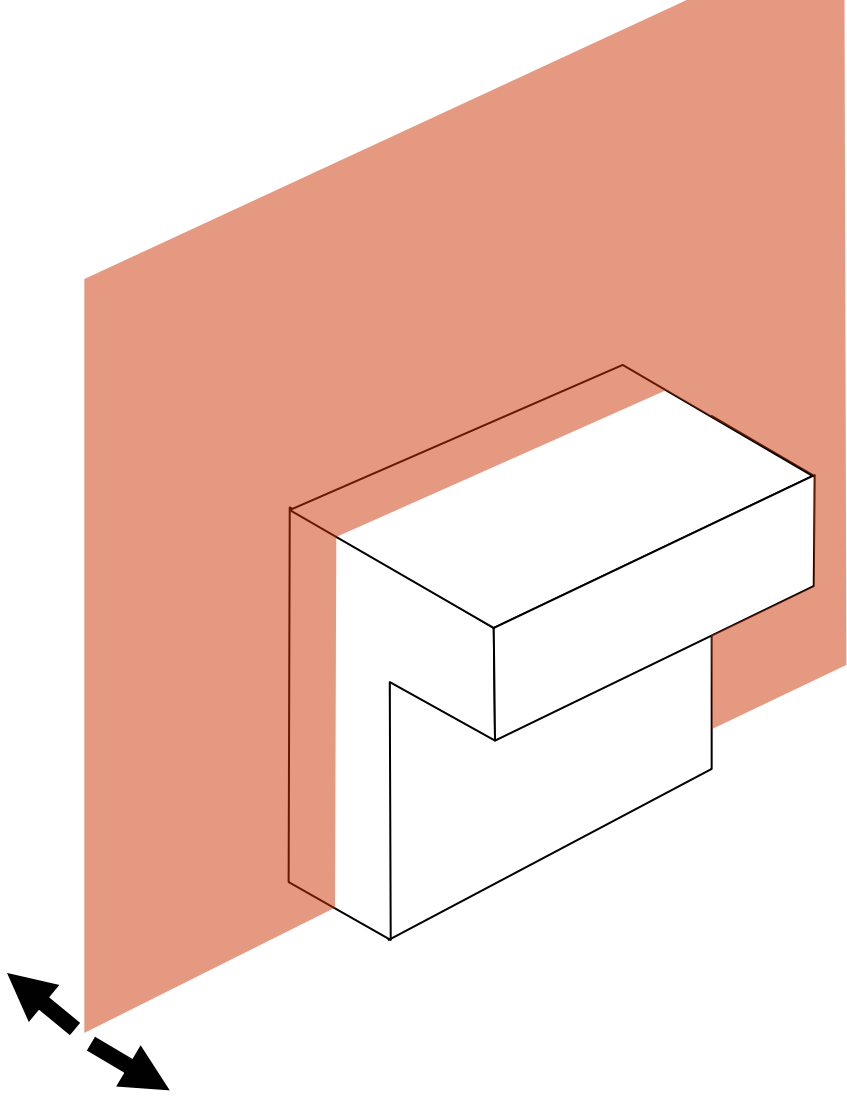

CORTE CON PLANO VERTICAL

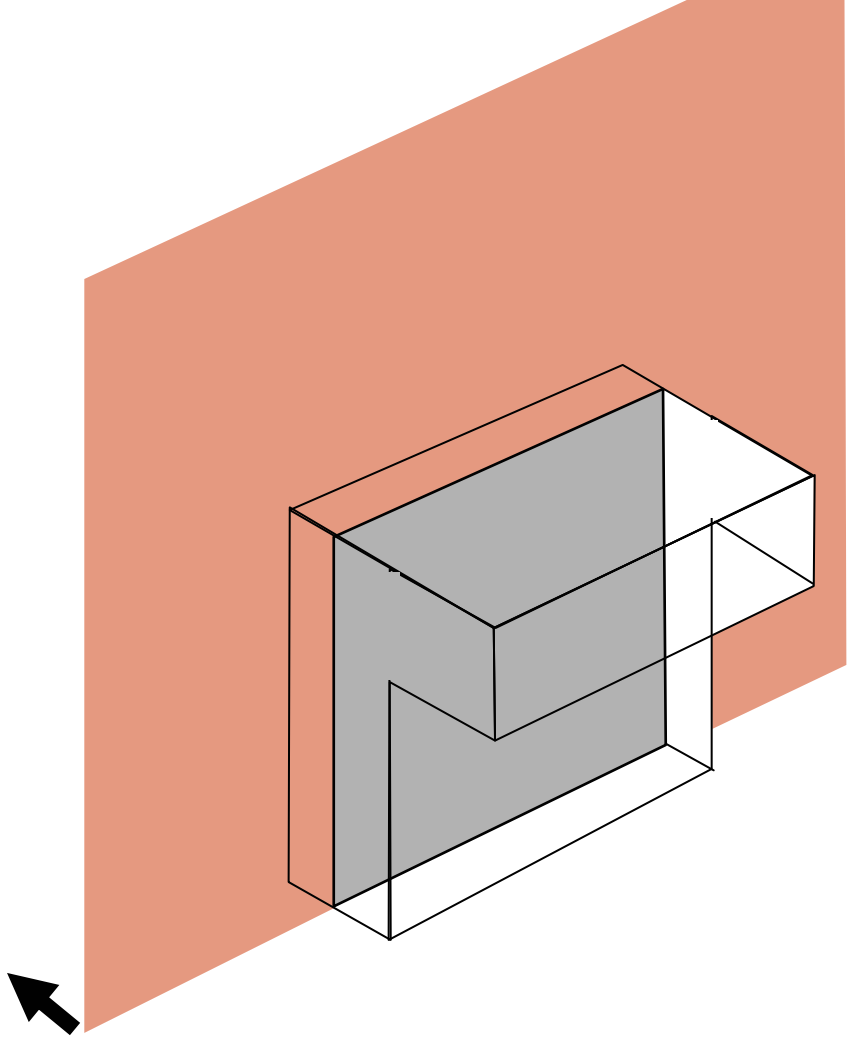

CORTE CON PLANO VERTICAL

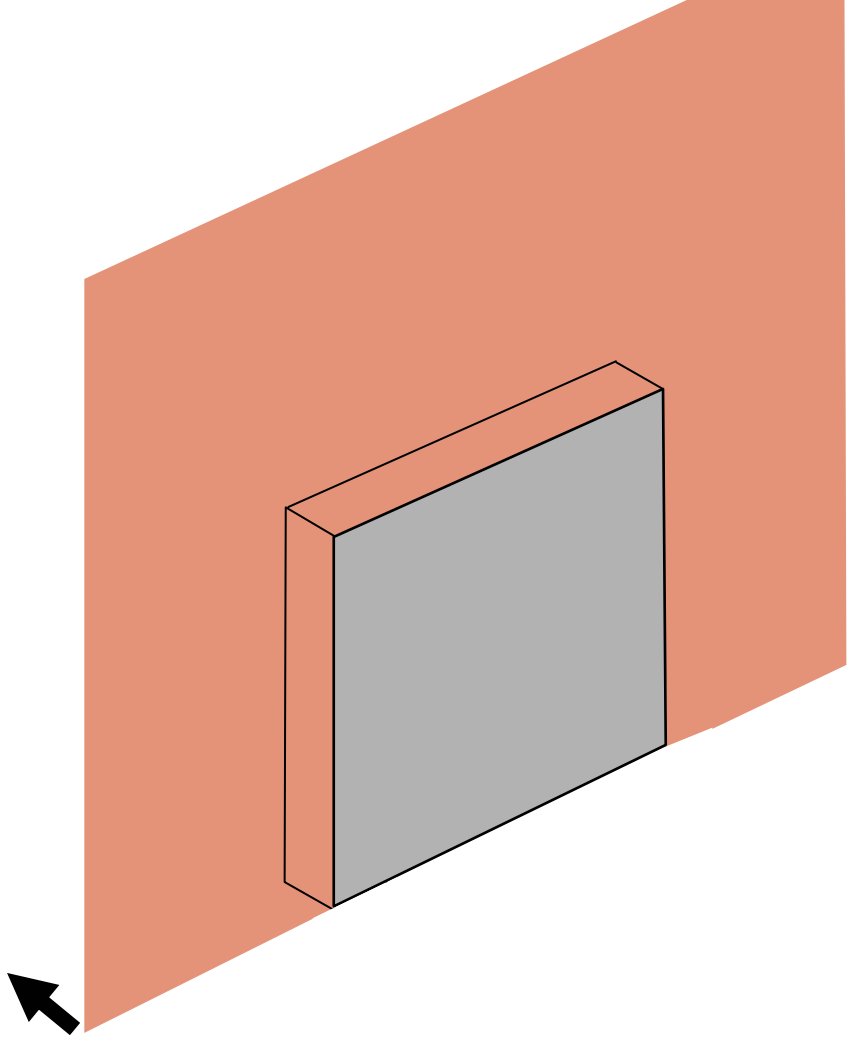

CORTE CON PLANO VERTICAL

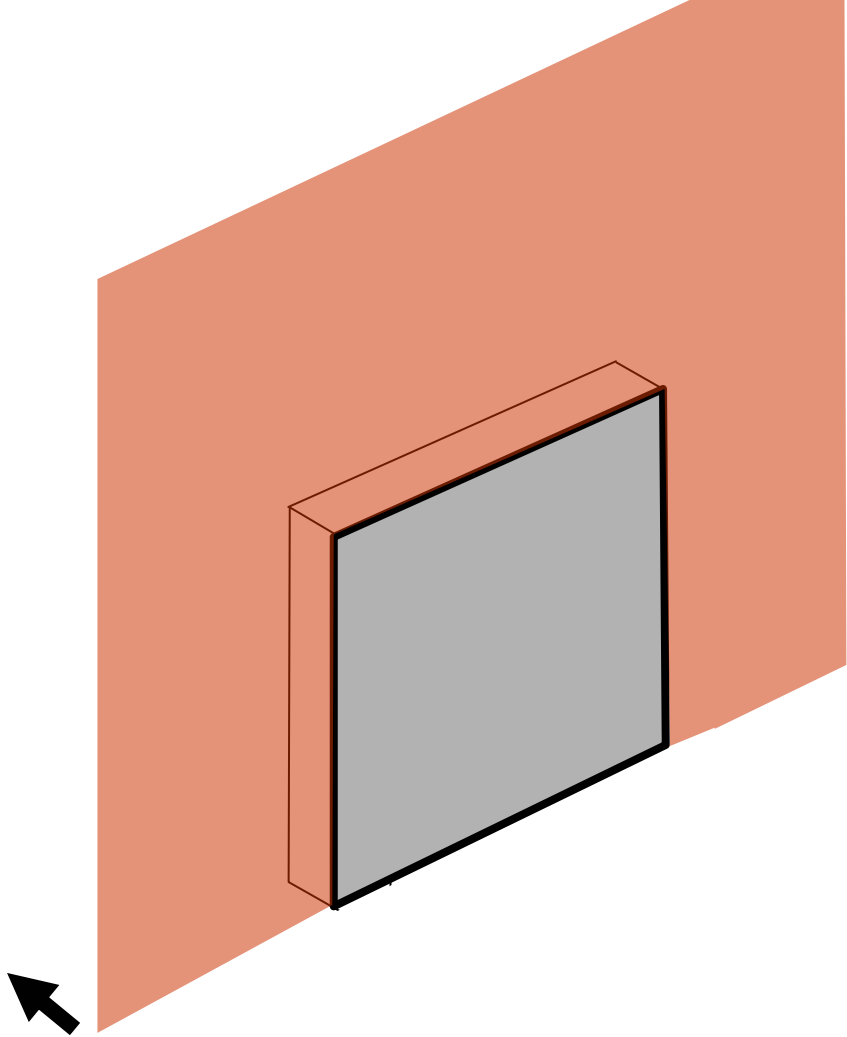

CORTE CON PLANO VERTICAL

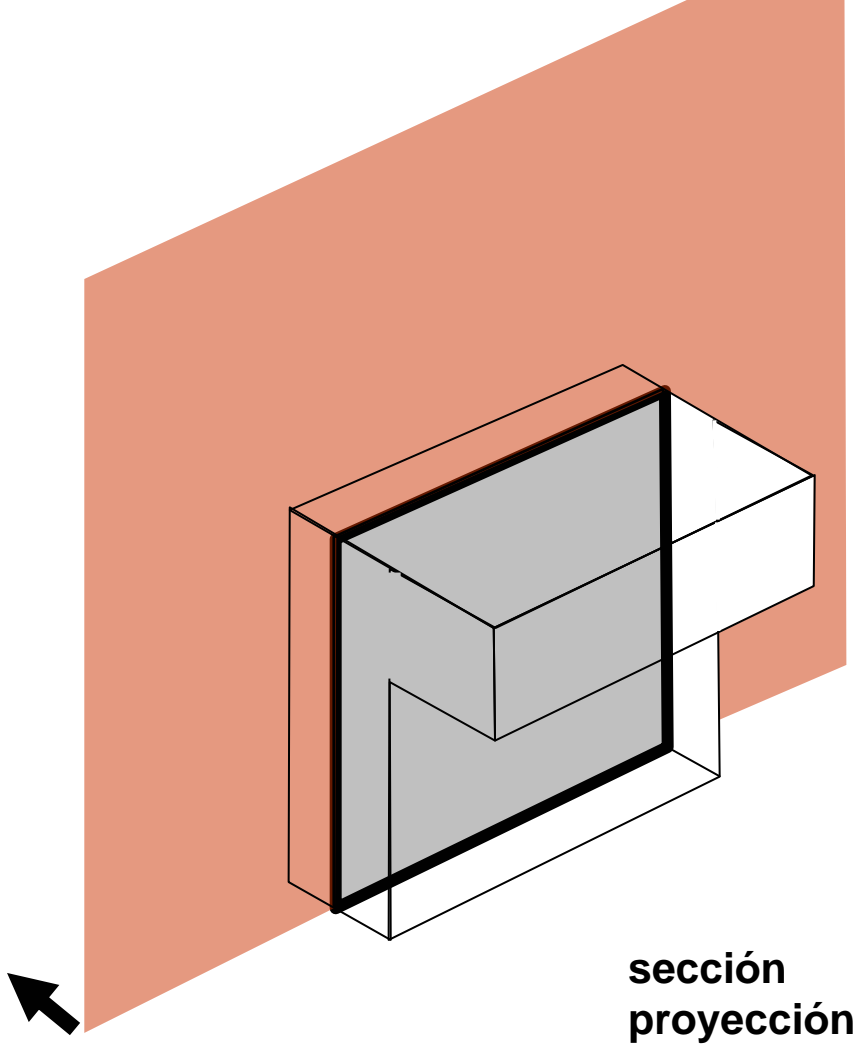

CORTE CON PLANO VERTICAL

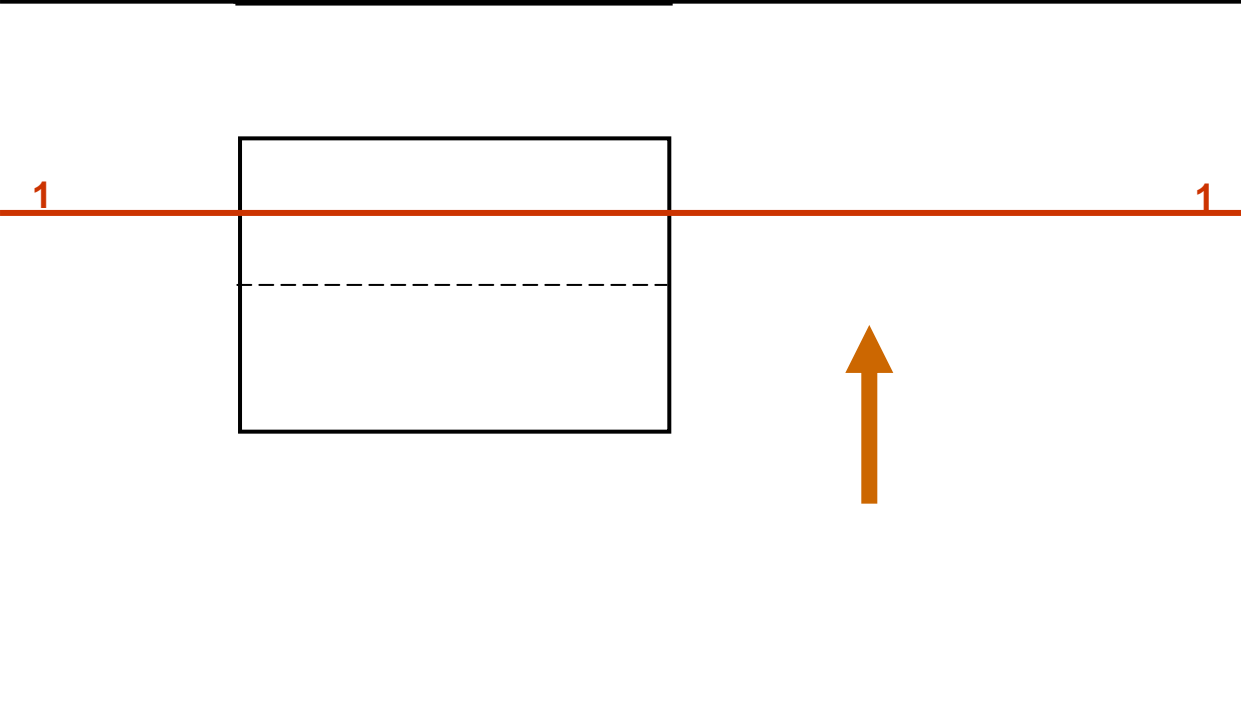
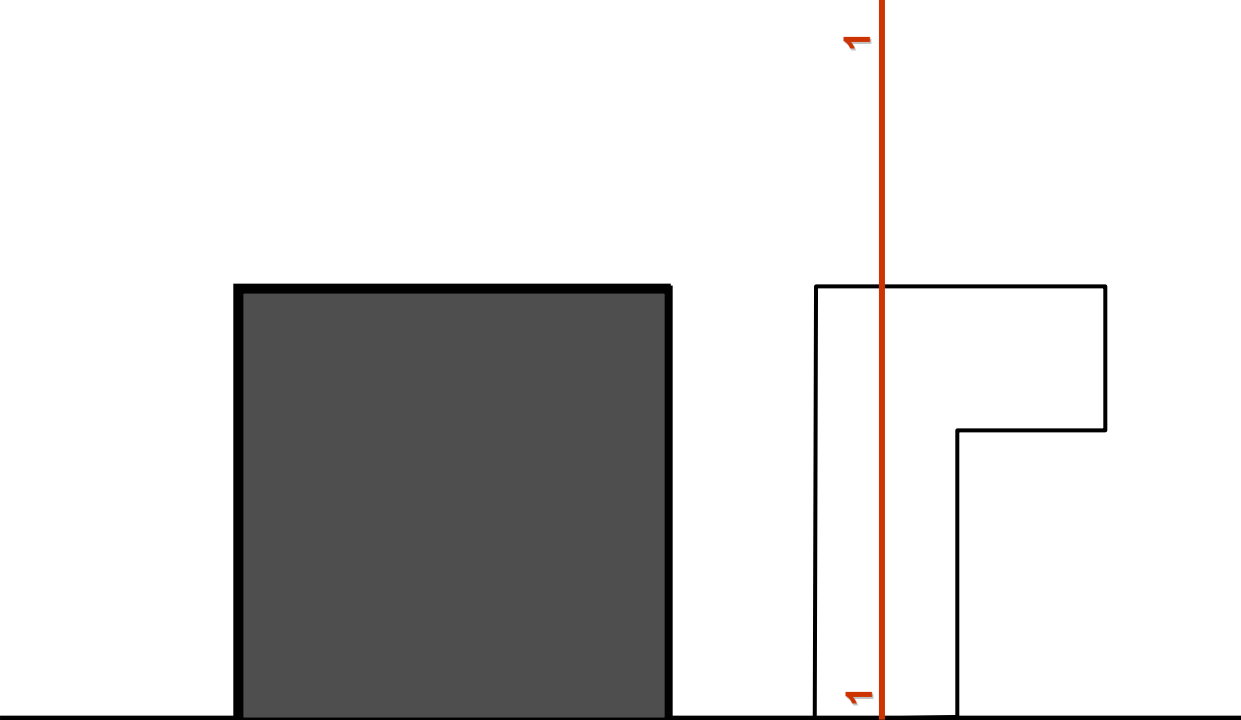

LT
CORTE 1
+ PLANTA TECHOS
+ FACHADA LATERAL

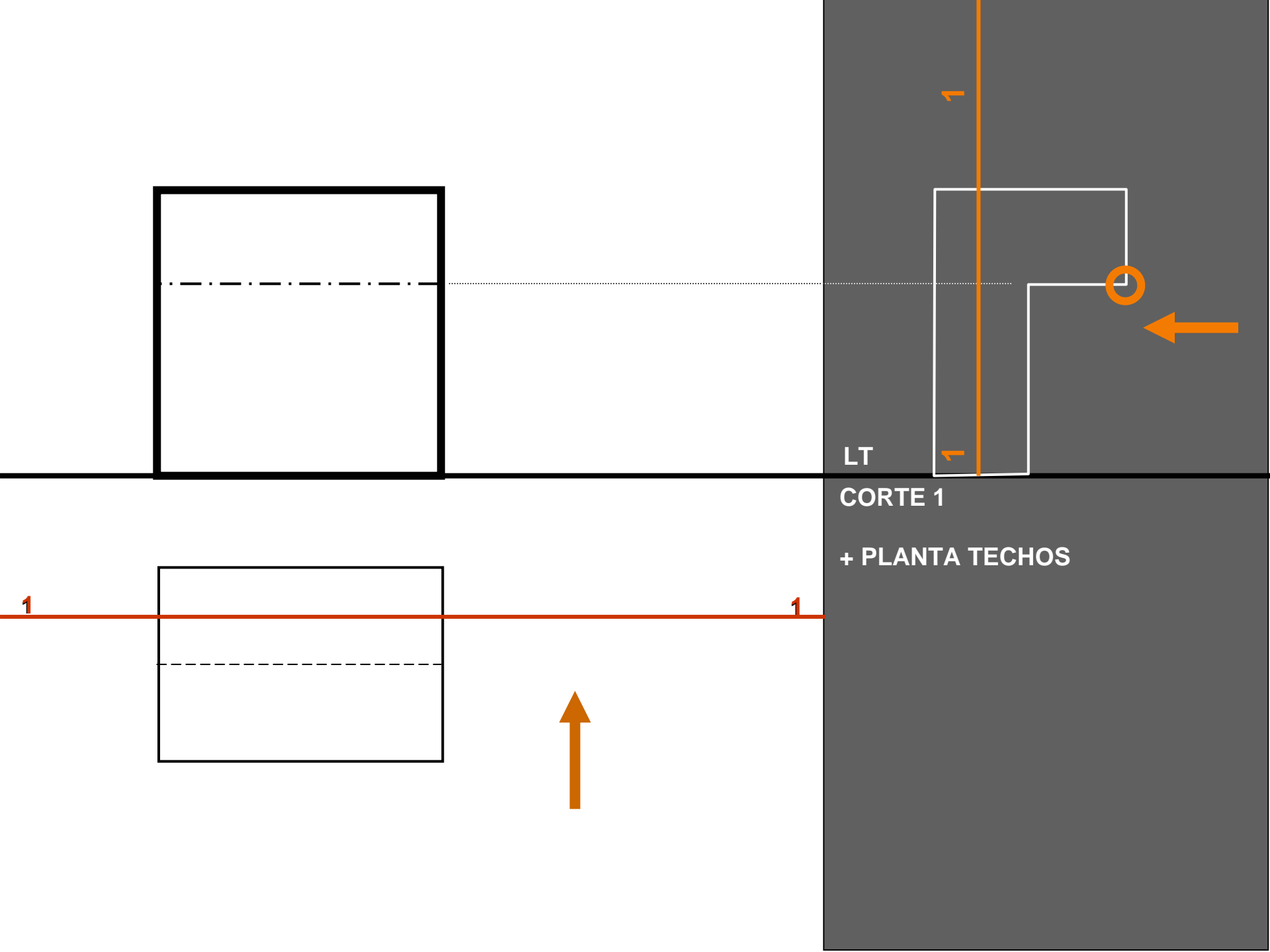

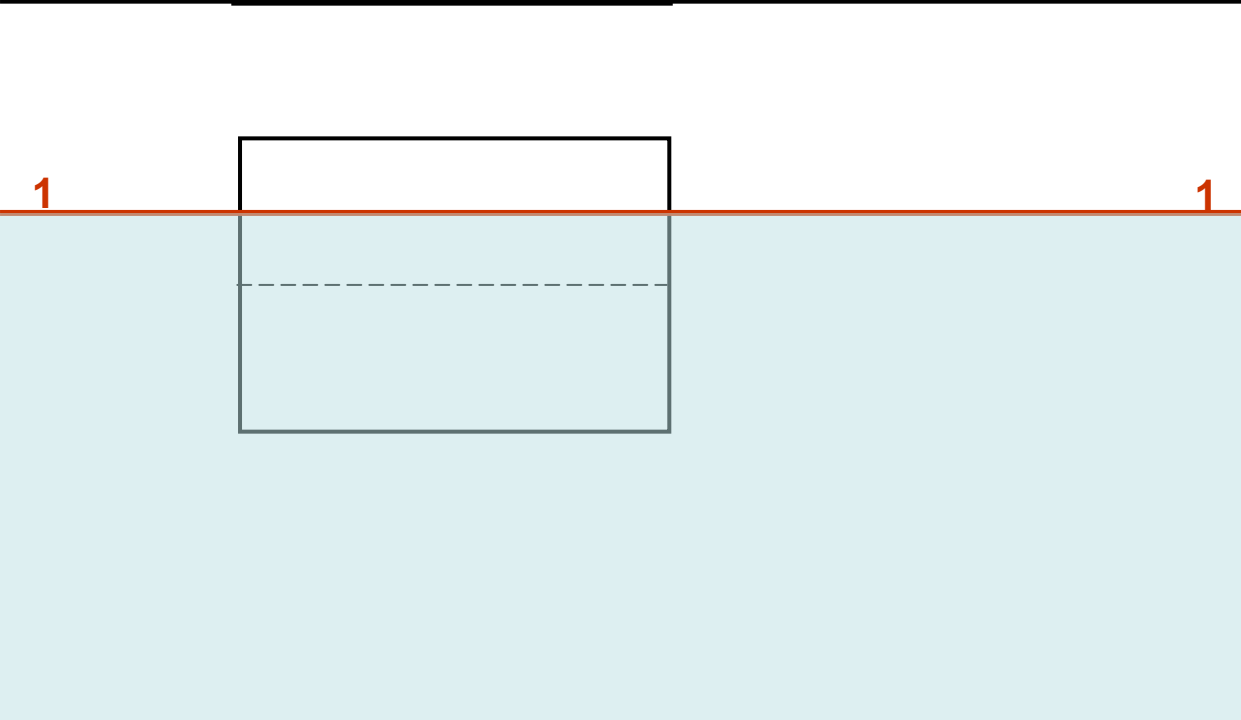
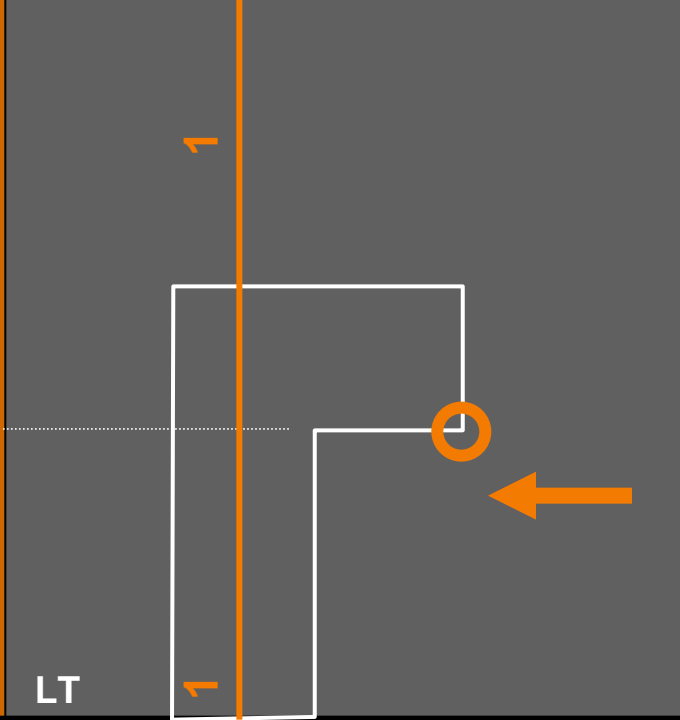
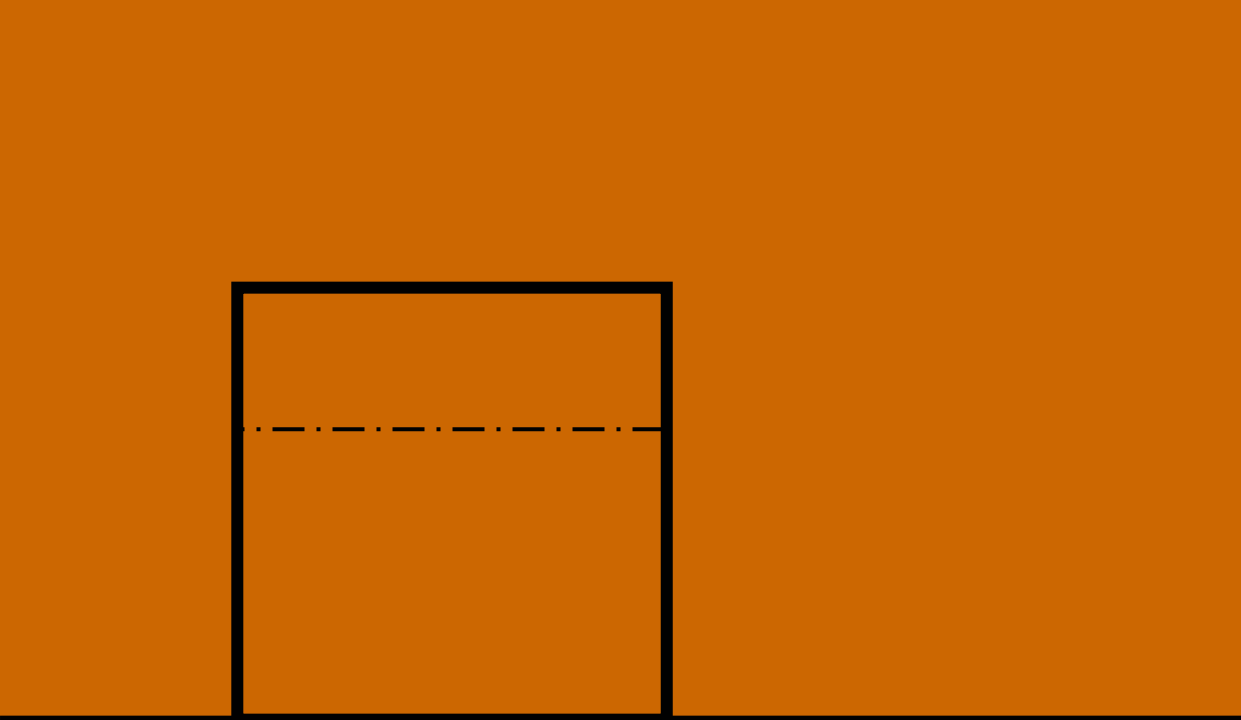

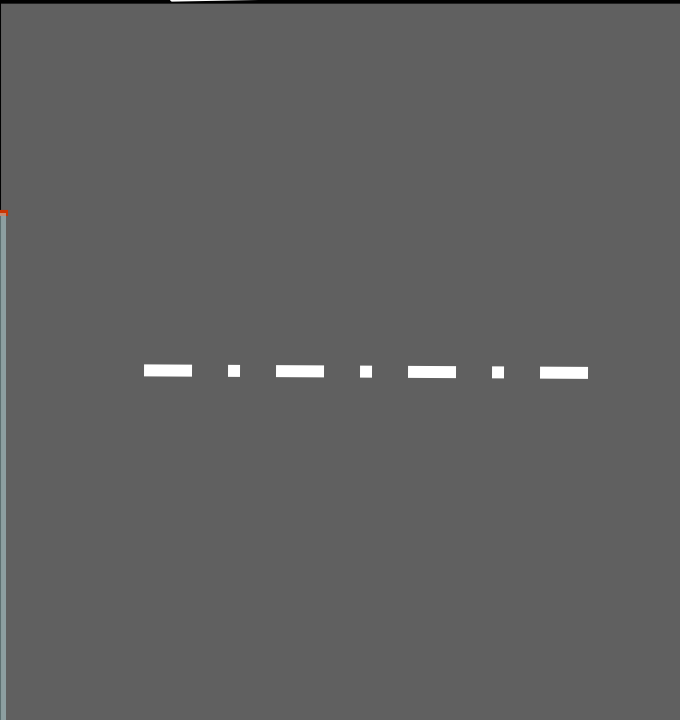
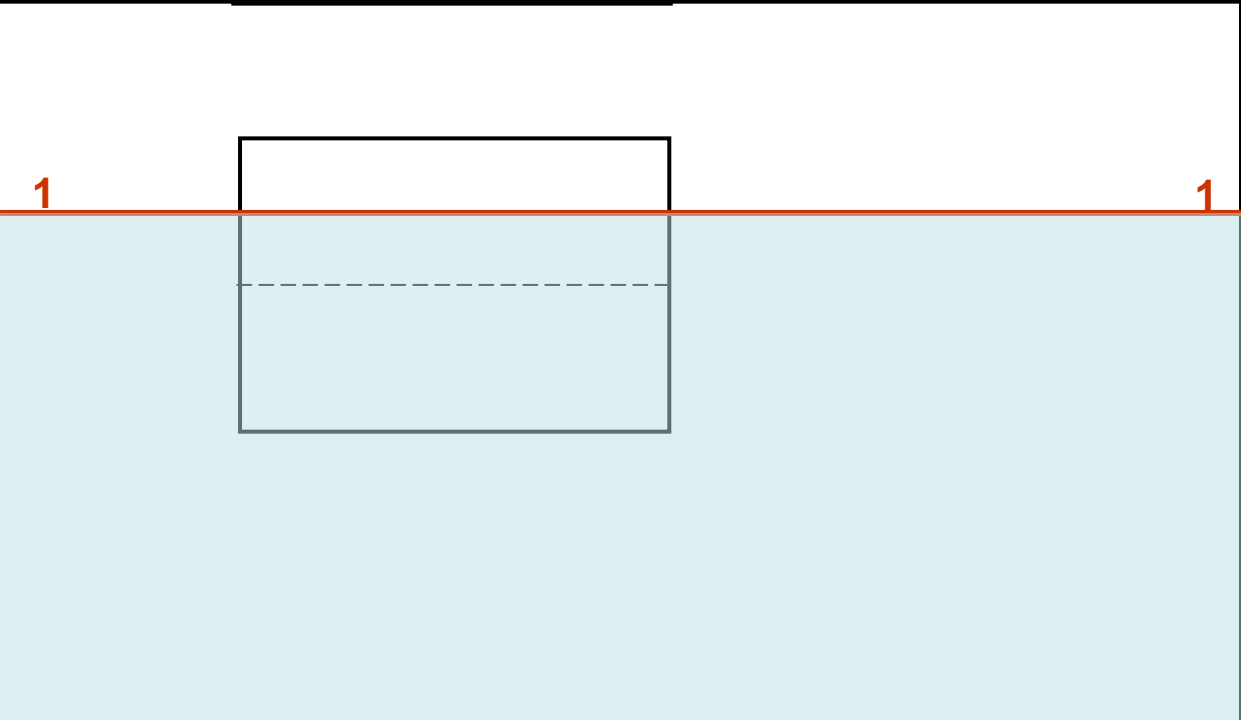
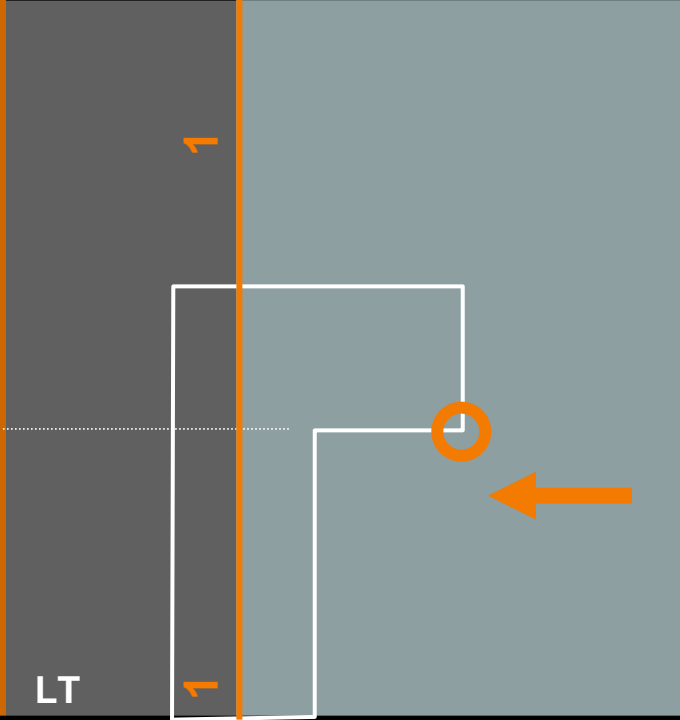
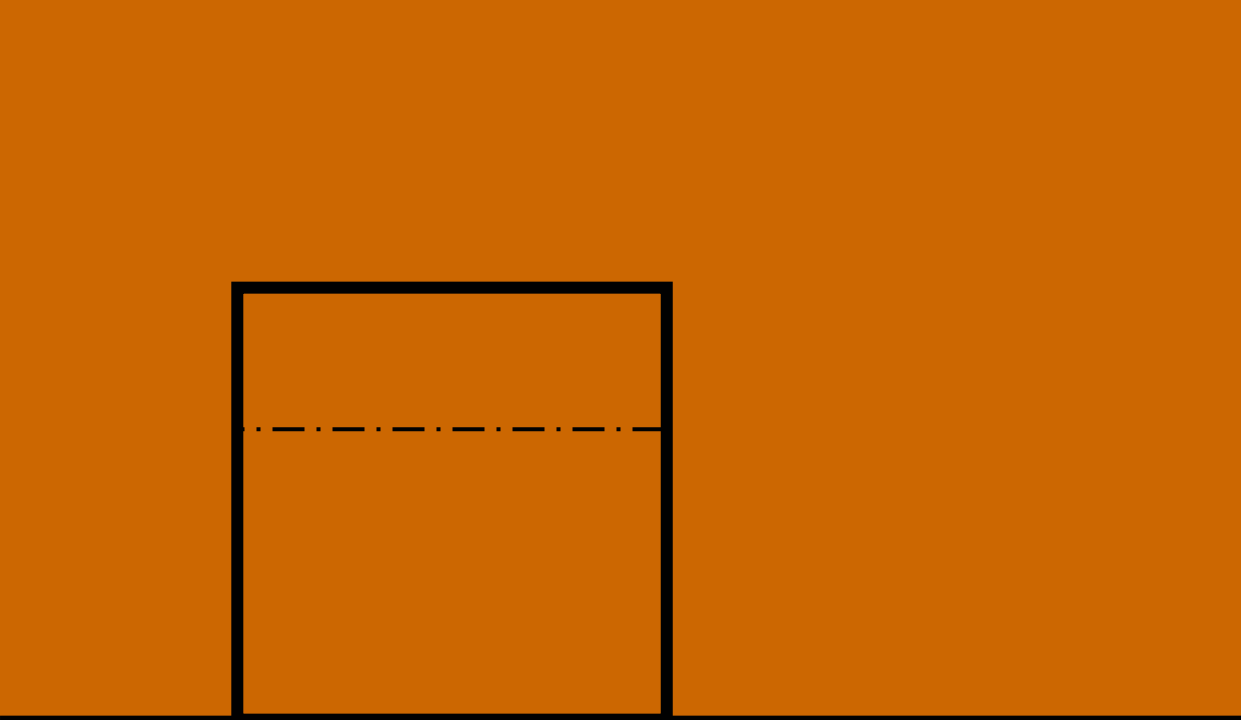

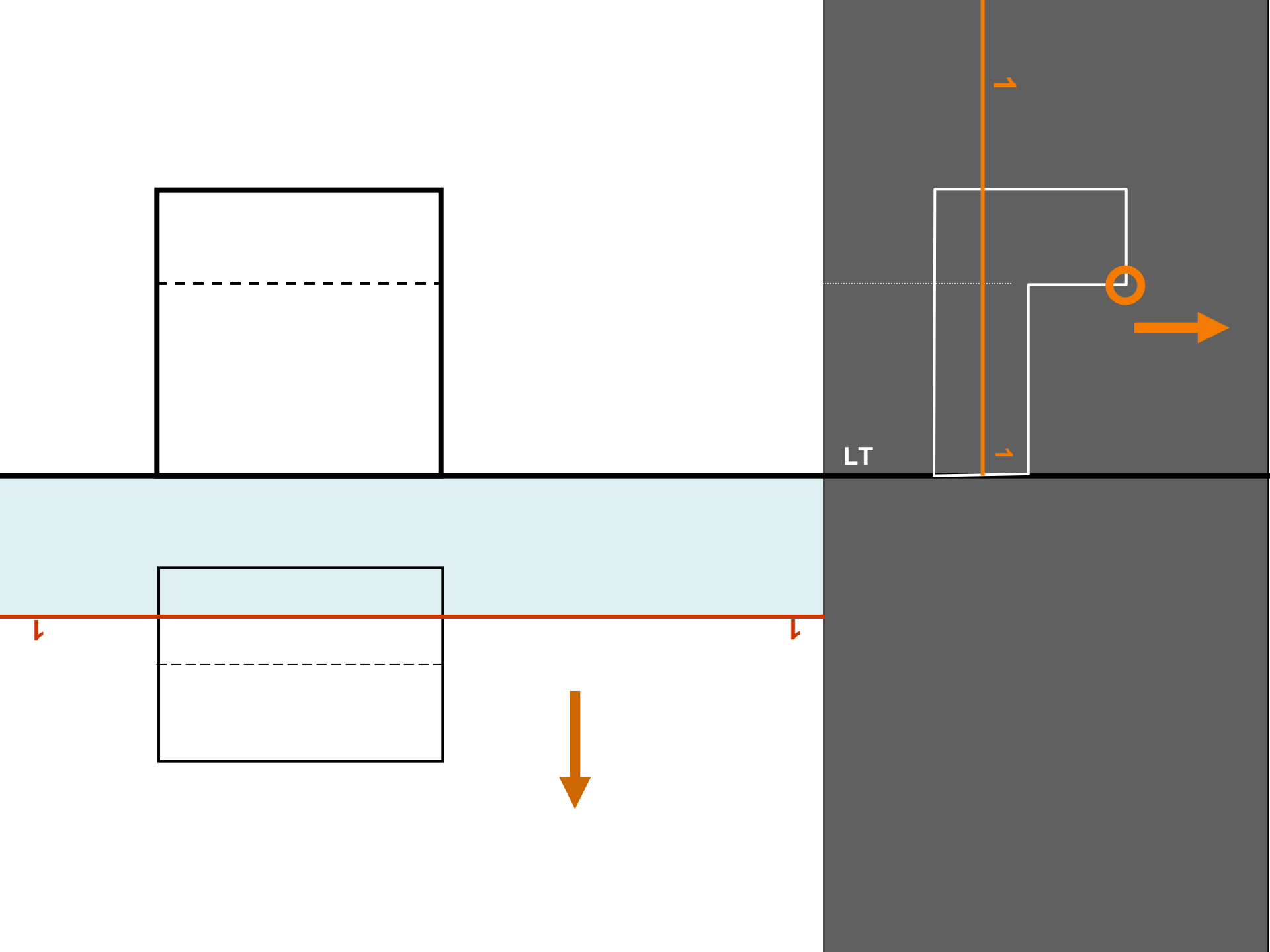

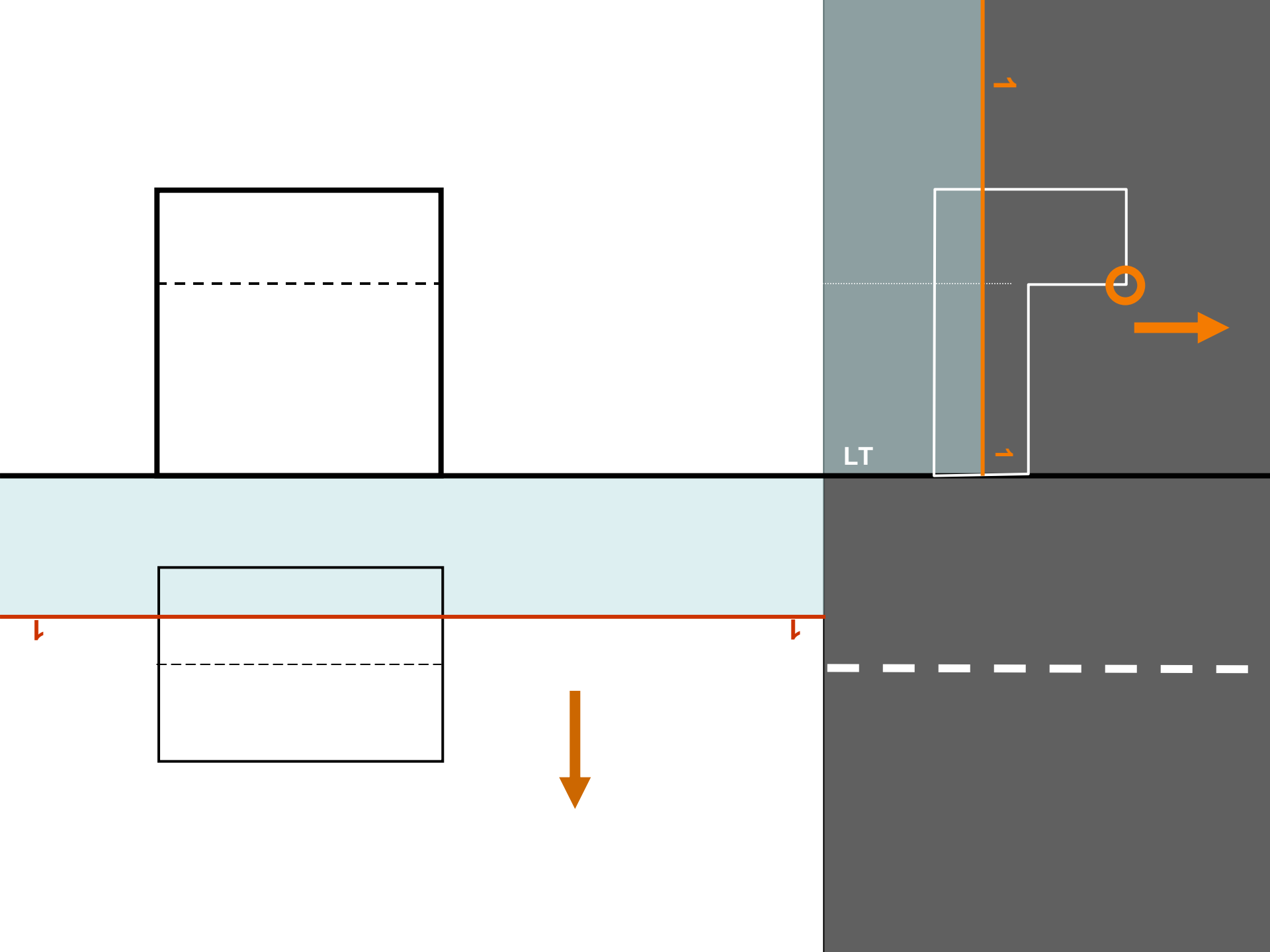

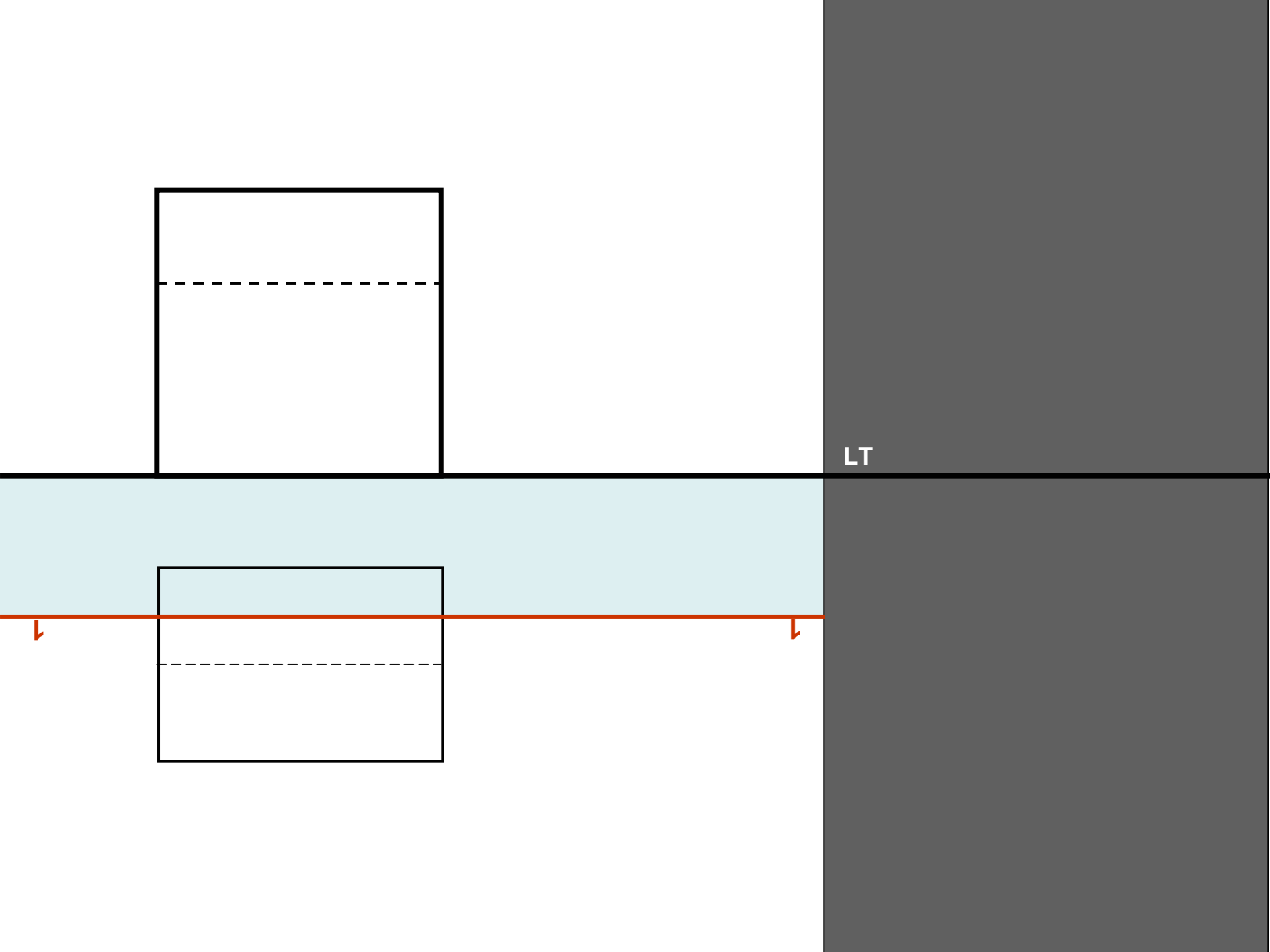

LT

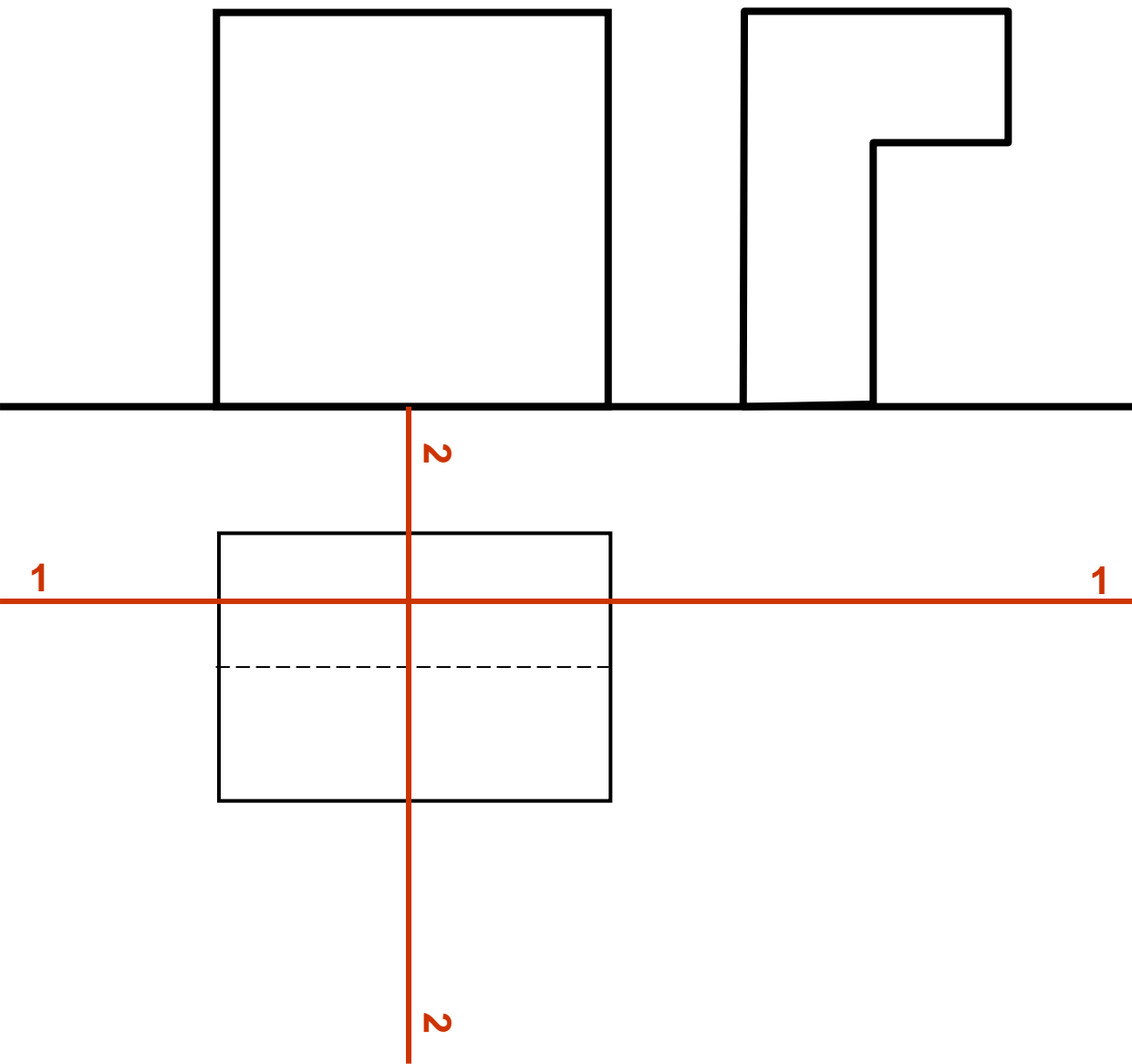

LT

CORTE 1 + CORTE 2

+ PLANTA TECHOS

+ FACHADA LATERAL



LT

CORTE 1 + CORTE 2

+ PLANTA TECHOS

+ FACHADA LATERAL

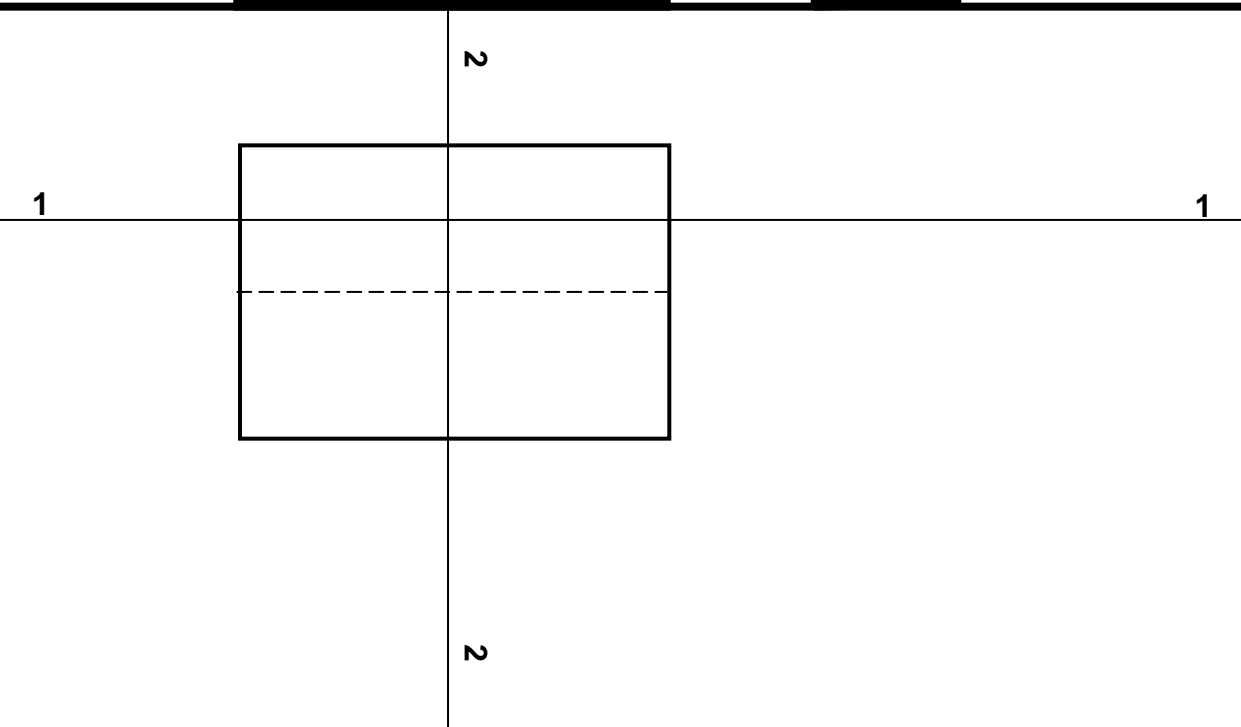

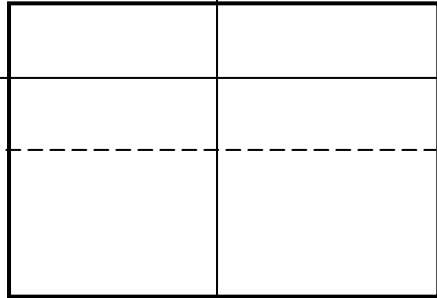
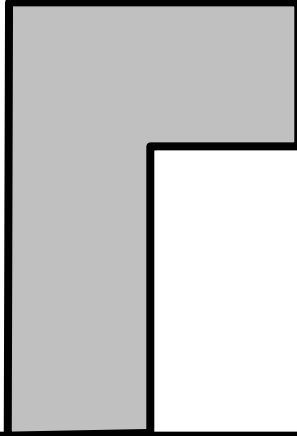
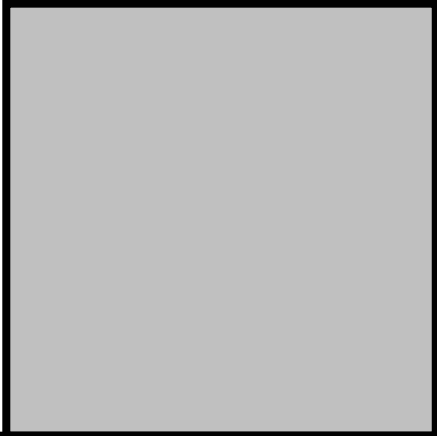

2

1

1

2

LT

CORTE 1 + CORTE 2

+ PLANTA TECHOS

+ FACHADA LATERAL

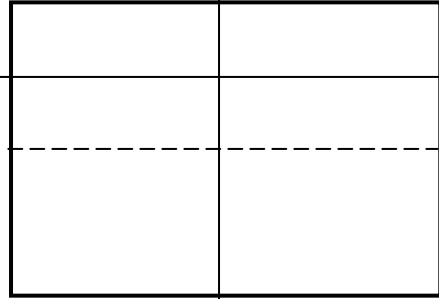
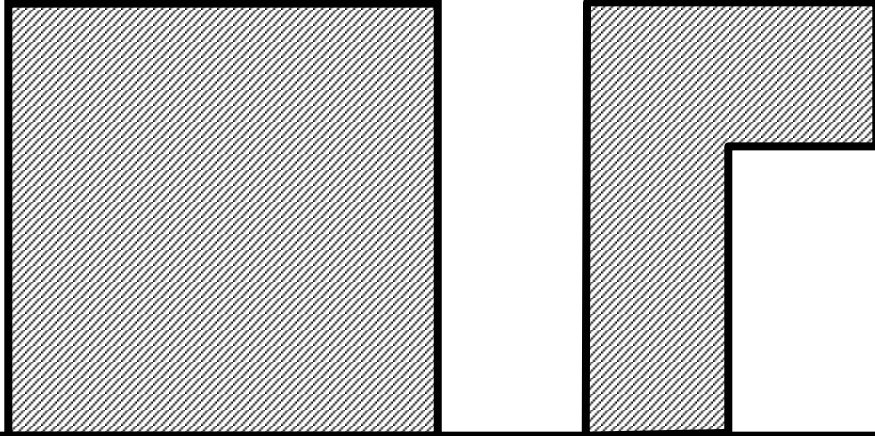

LT

CORTE 1 + CORTE 2

+ PLANTA TECHOS

+ FACHADA LATERAL

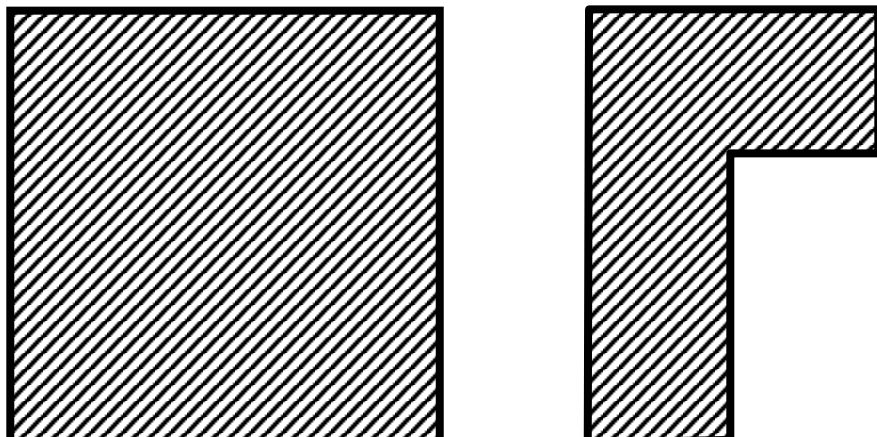

LT

CORTE 1 + CORTE 2

+ PLANTA TECHOS

+ FACHADA LATERAL

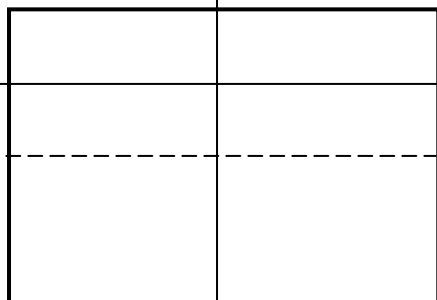

2

1

1

2

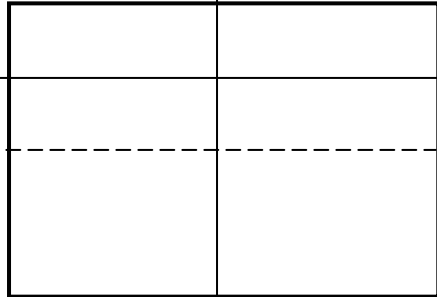
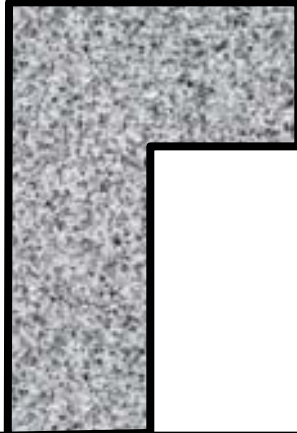
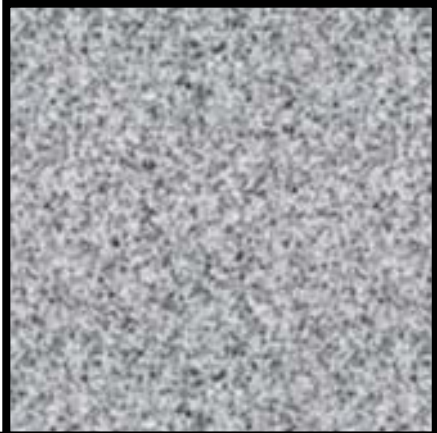

LT

CORTE 1 + CORTE 2

+ PLANTA TECHOS

+ FACHADA LATERAL

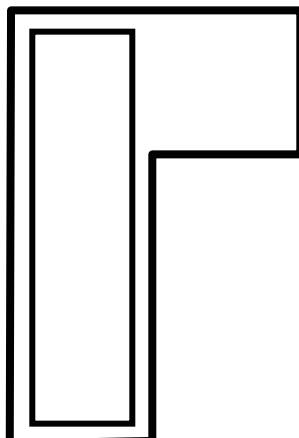
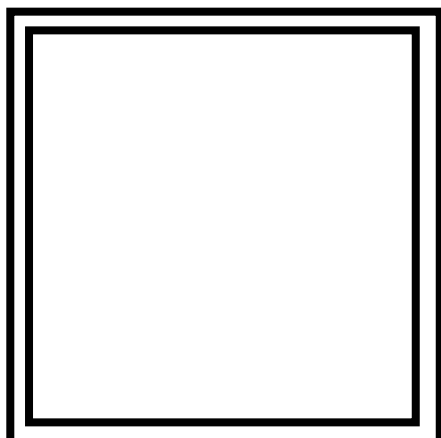

LT

CORTE 1 + CORTE 2

+ PLANTA TECHOS

+ FACHADA LATERAL

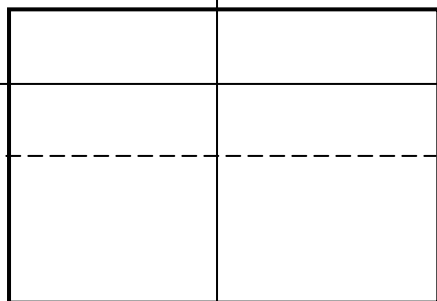

2

1

1

2

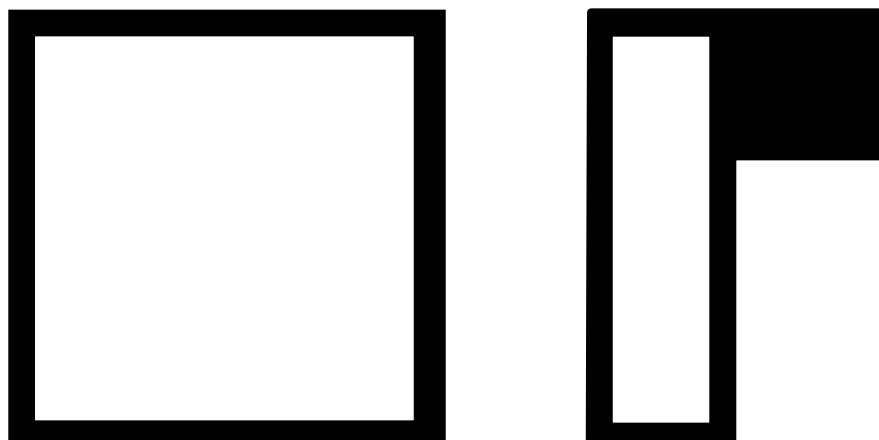

LT

CORTE 1 + CORTE 2

+ PLANTA TECHOS

+ FACHADA LATERAL

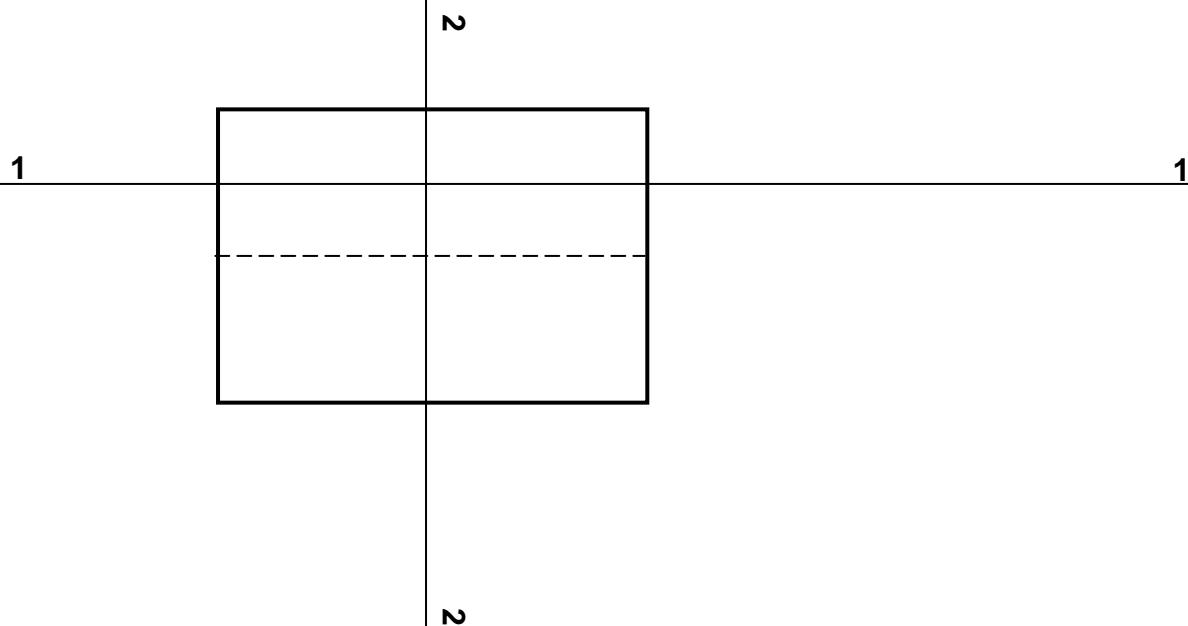

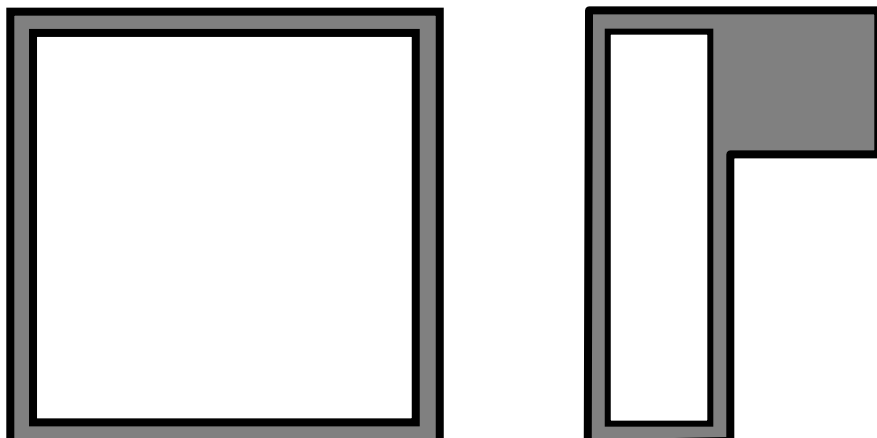

LT

CORTE 1 + CORTE 2

+ PLANTA TECHOS

+ FACHADA LATERAL

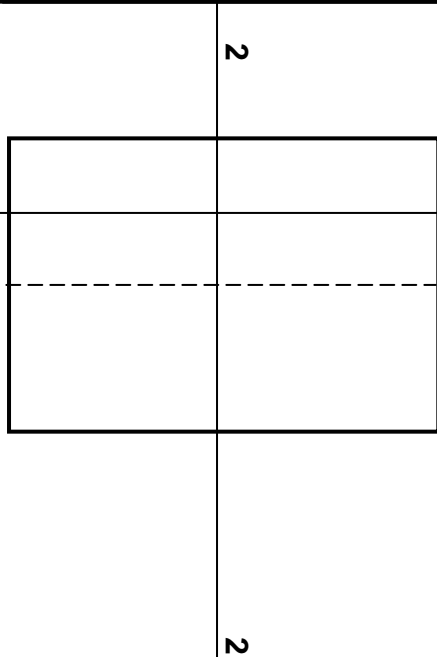

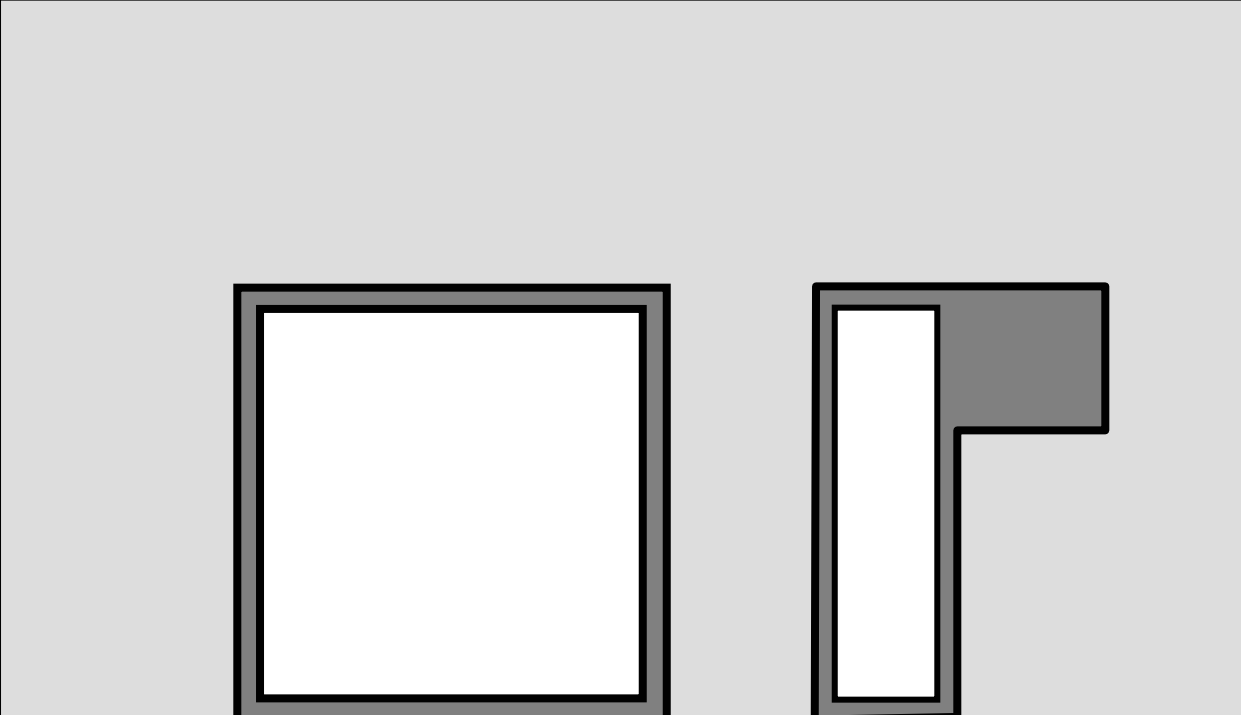

LT

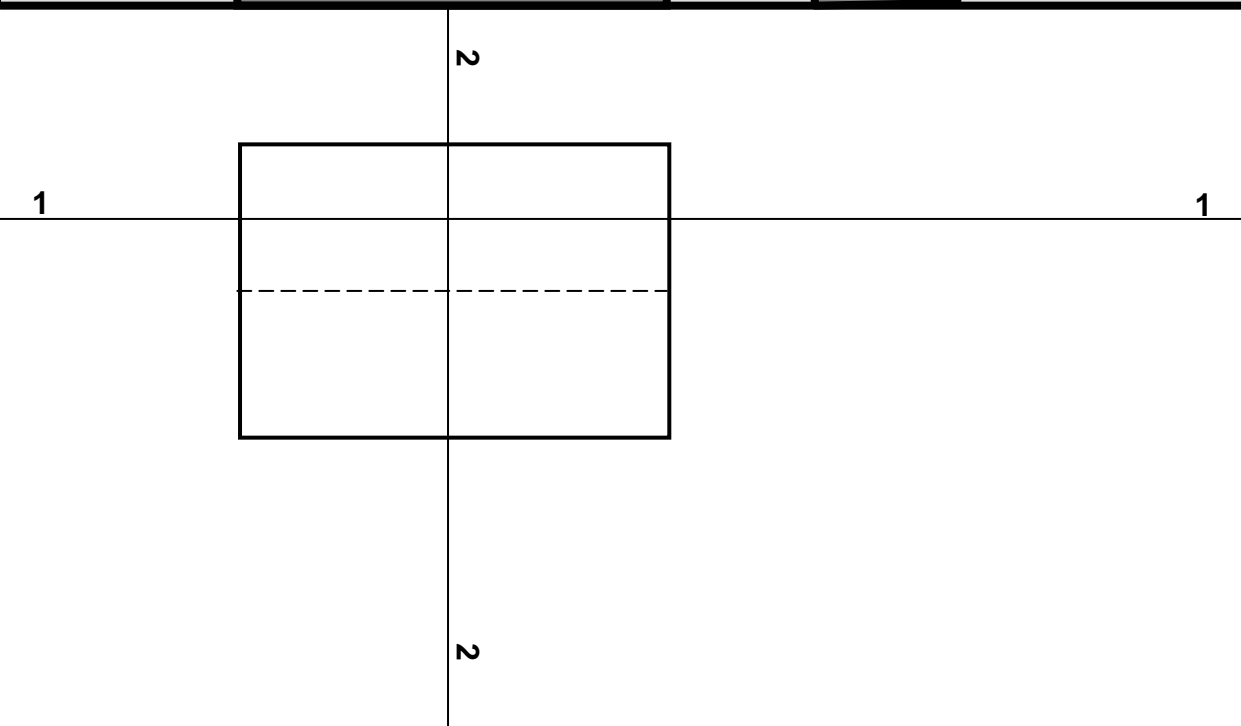

CORTE 1 + CORTE 2

+ PLANTA TECHOS

+ FACHADA LATERAL

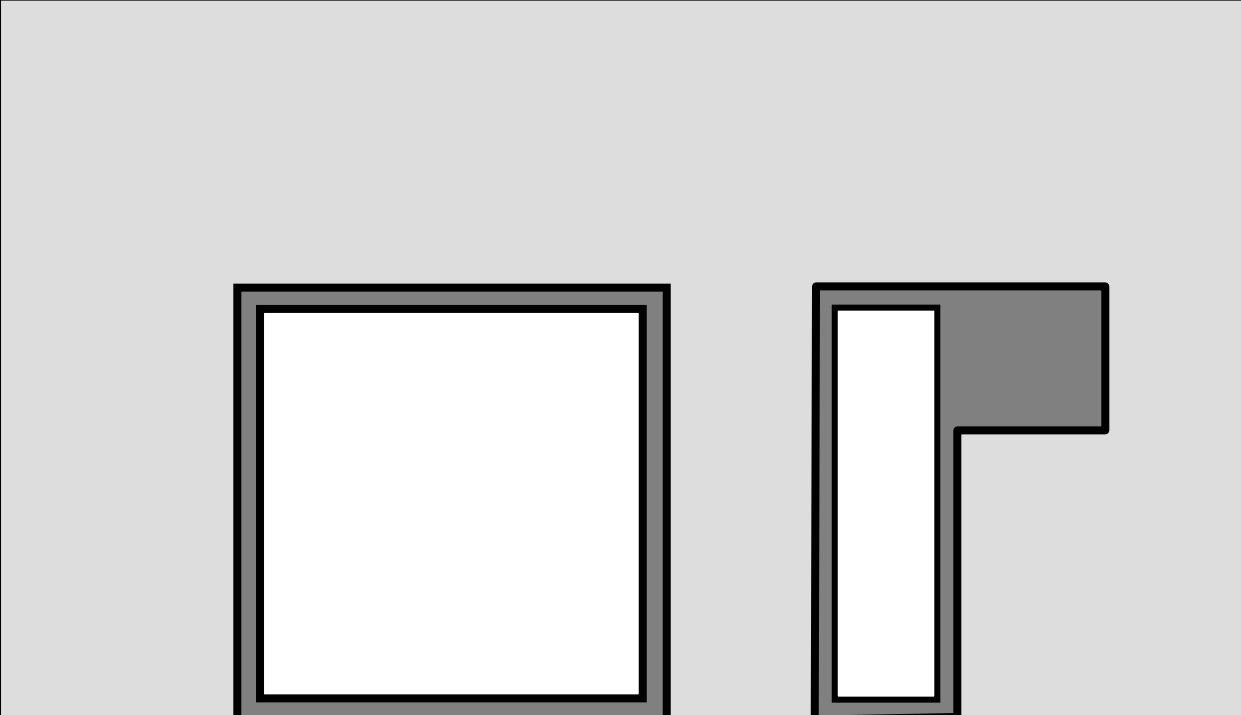

LT

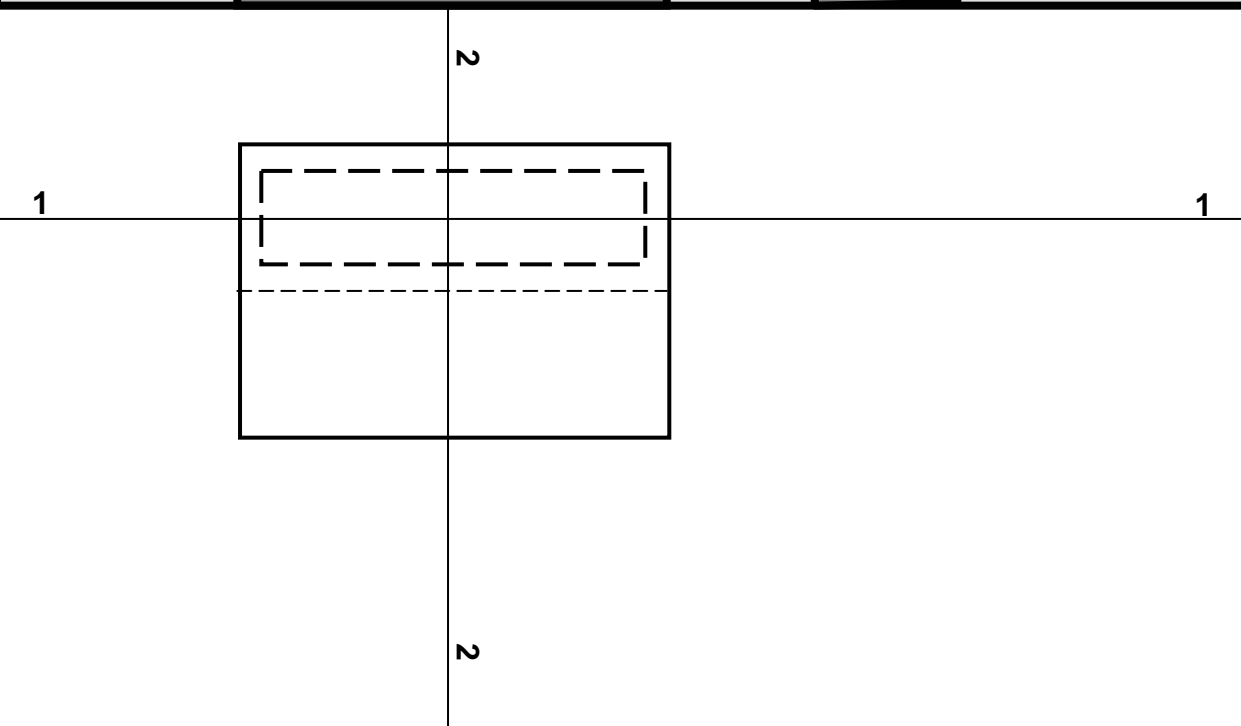

CORTE 1 + CORTE 2

+ PLANTA TECHOS

+ FACHADA LATERAL

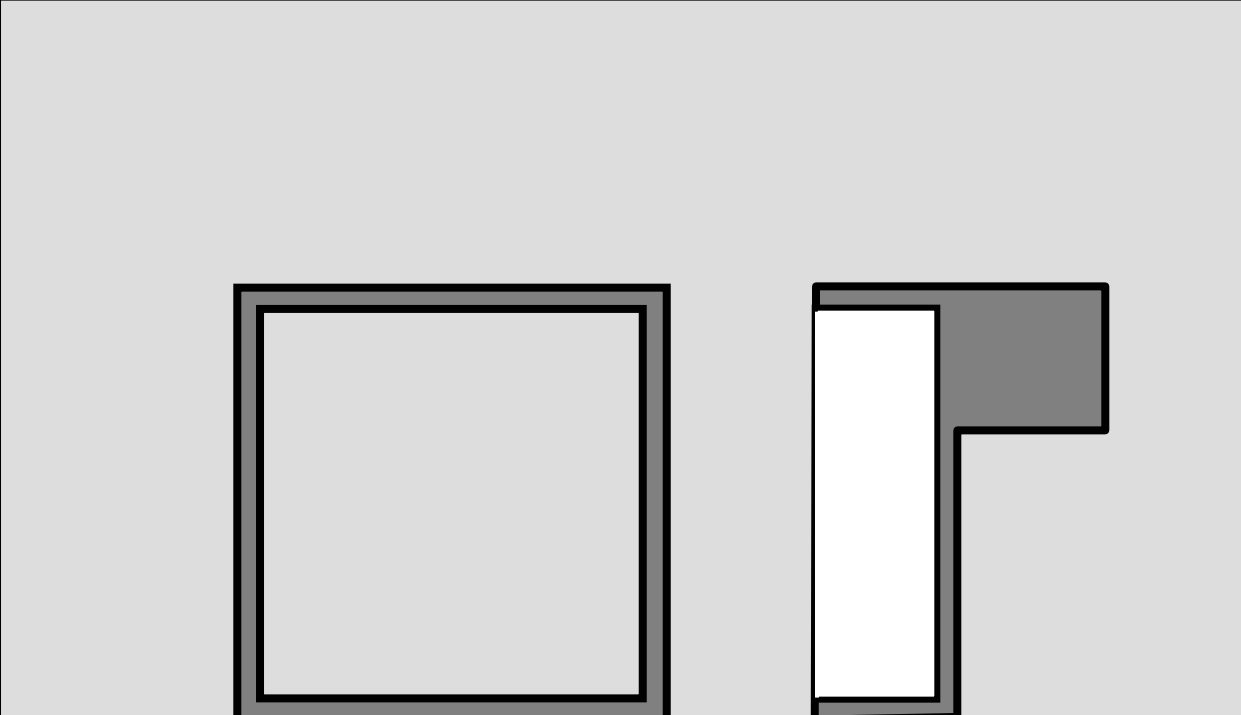

LT

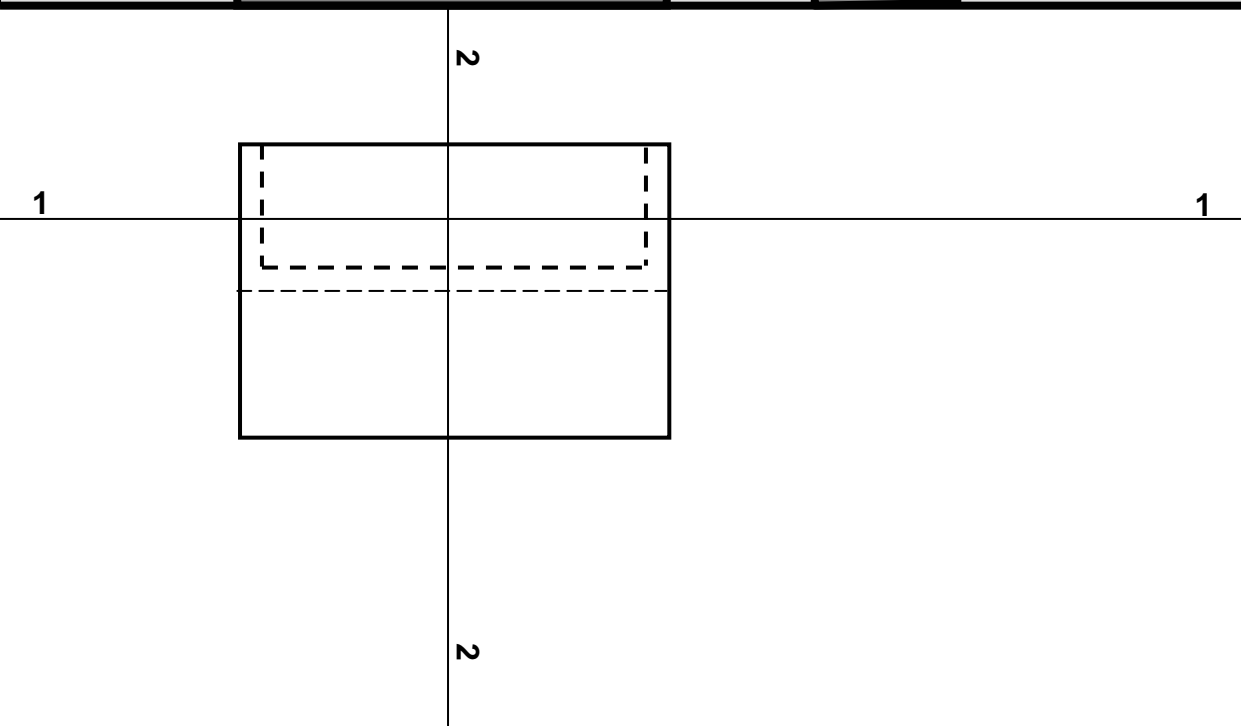

CORTE 1 + CORTE 2

+ PLANTA TECHOS

+ FACHADA LATERAL

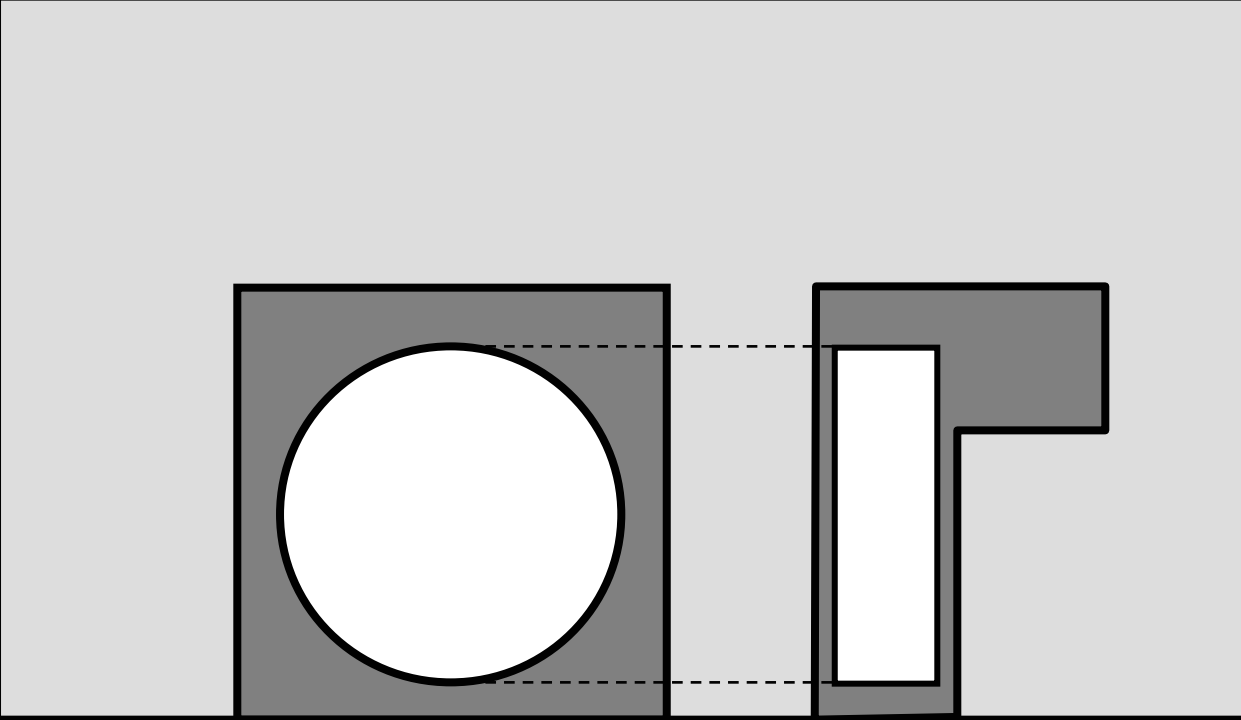

LT

CORTE 1 + CORTE 2

+ PLANTA TECHOS

+ FACHADA LATERAL

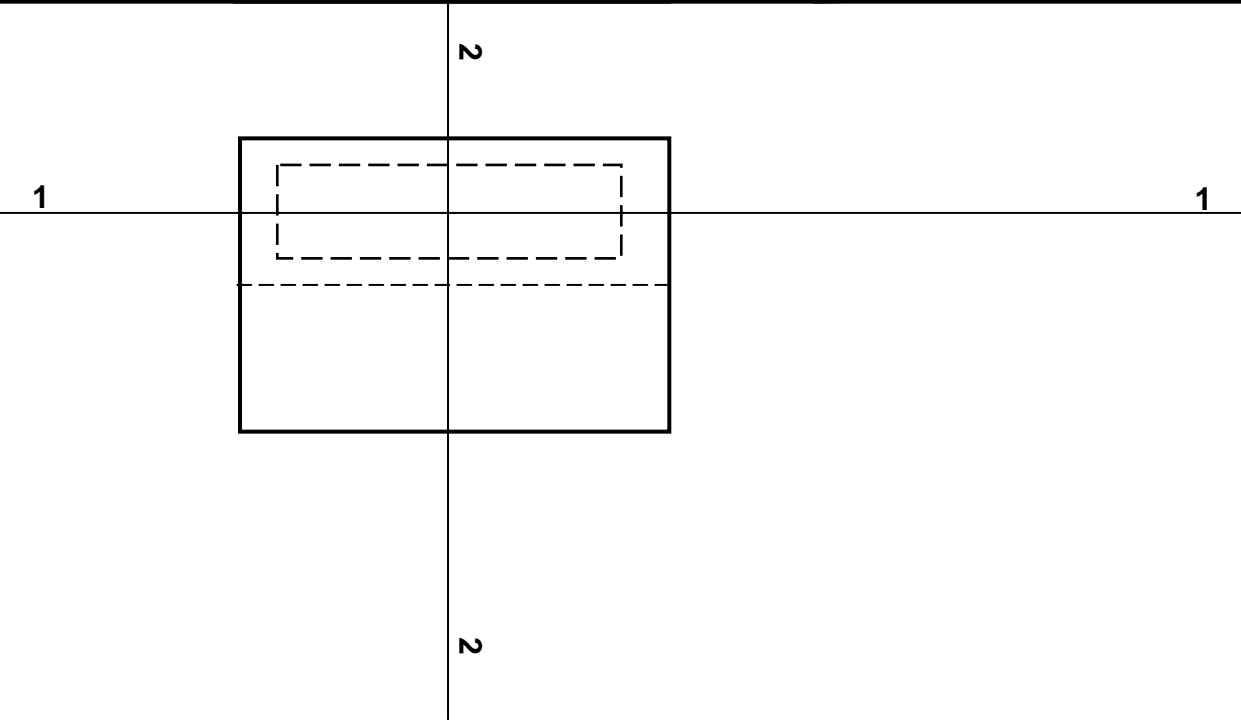

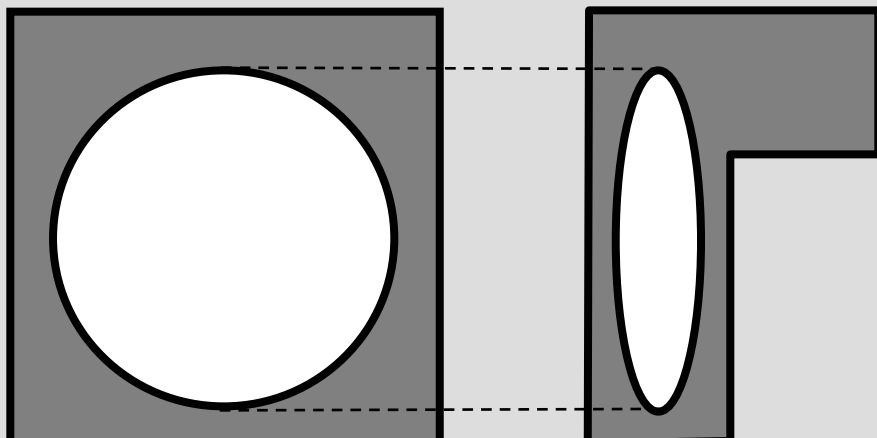

LT

CORTE 1 + CORTE 2

+ PLANTA TECHOS

+ FACHADA LATERAL

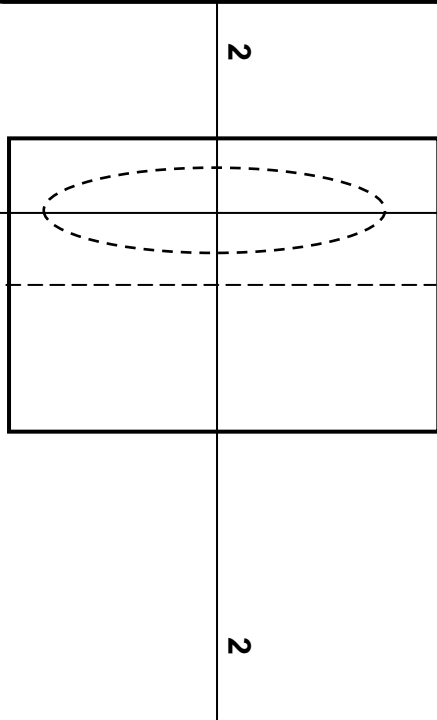

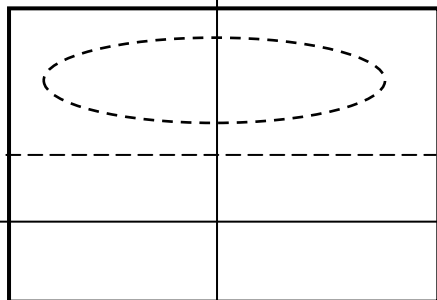
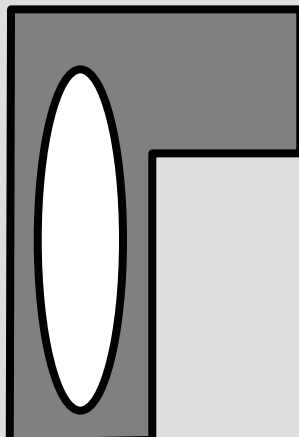
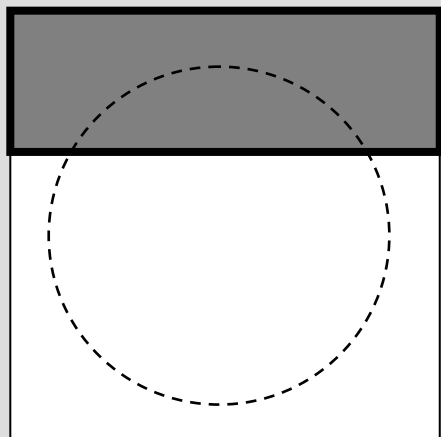

2

1

1

2

LT

CORTE 1 + CORTE 2

+ PLANTA TECHOS

+ FACHADA LATERAL

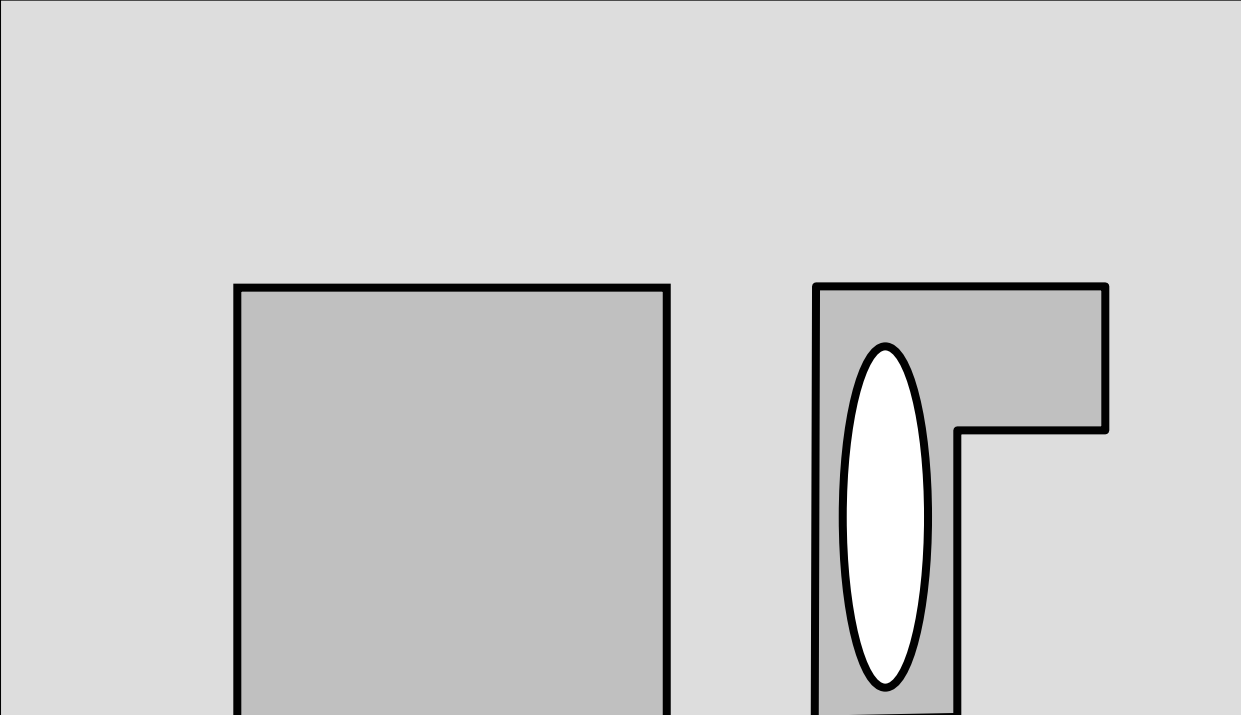

LT

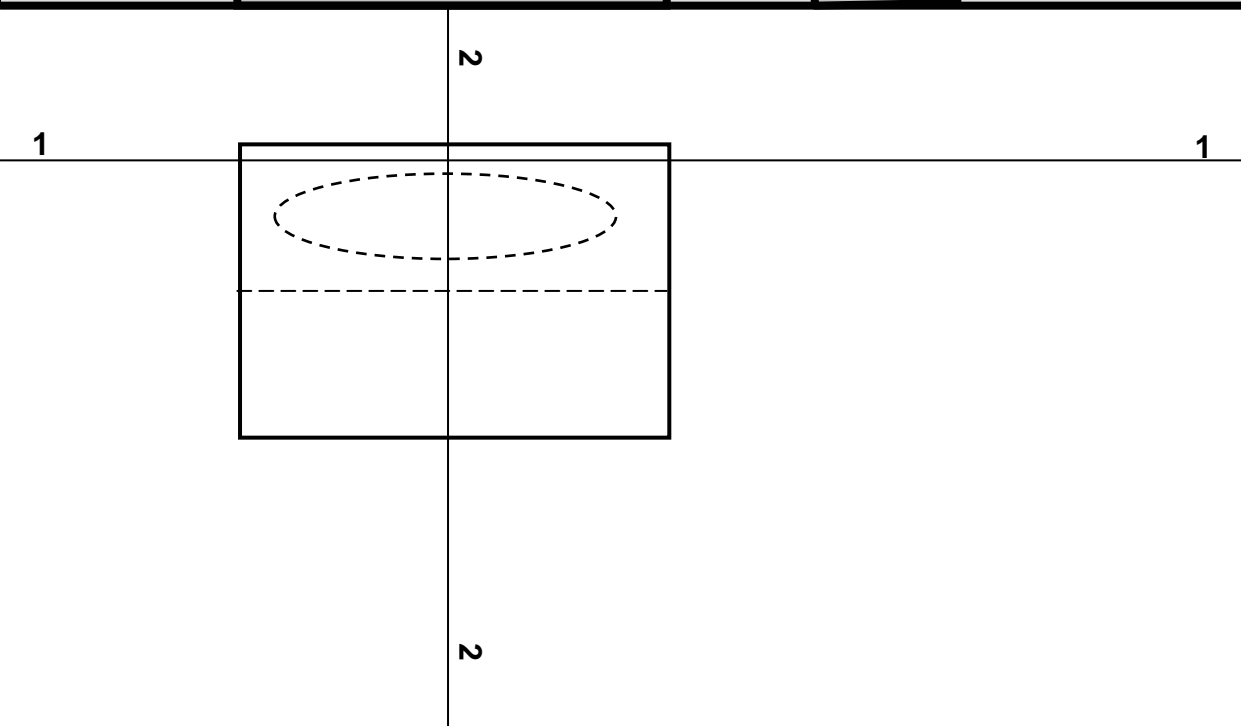

CORTE 1 + CORTE 2

+ PLANTA TECHOS

+ FACHADA LATERAL

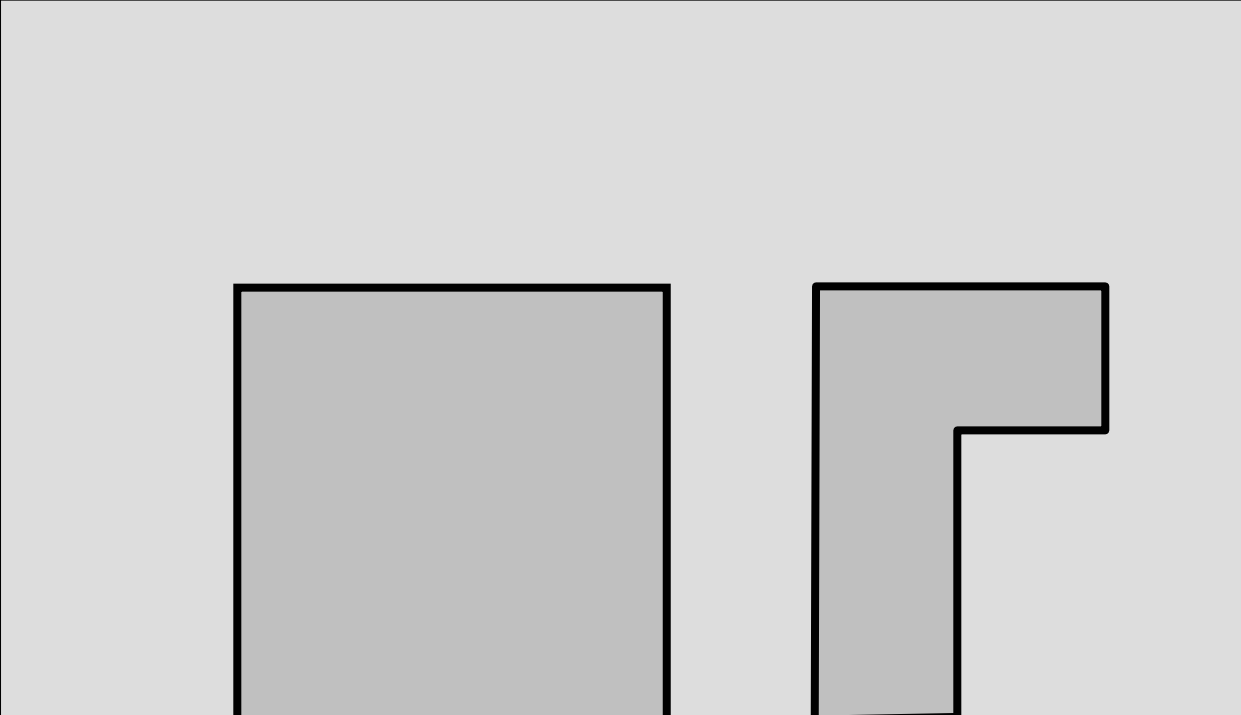

LT

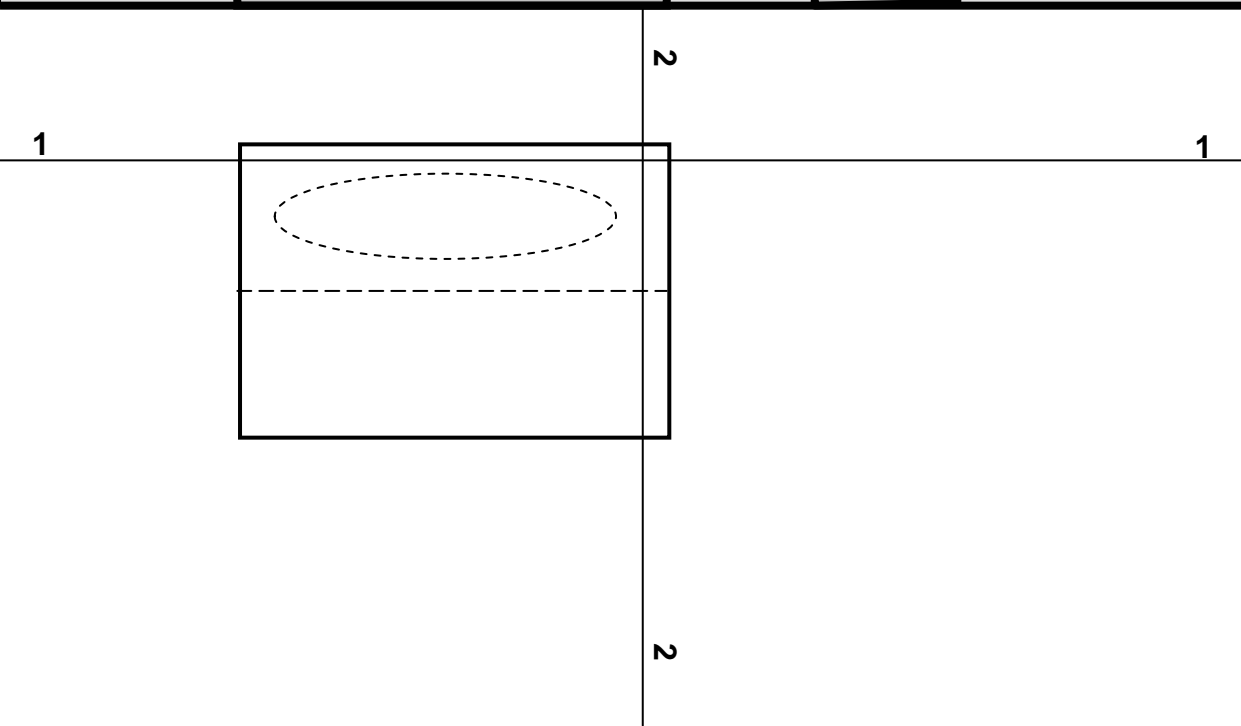

CORTE 1 + CORTE 2

+ PLANTA TECHOS

+ FACHADA LATERAL

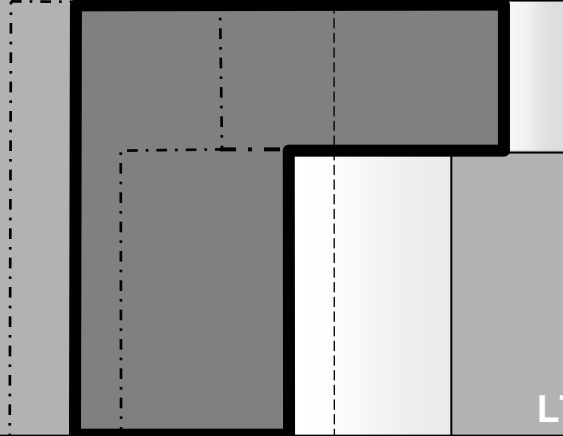
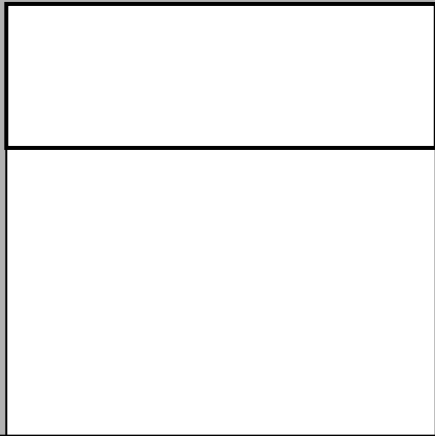

LT

CORTE 1

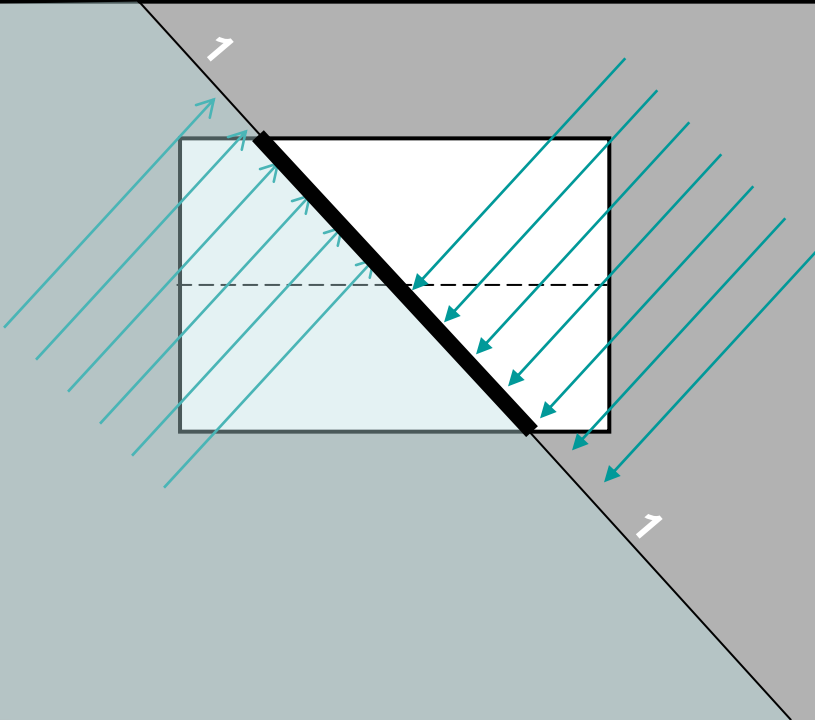

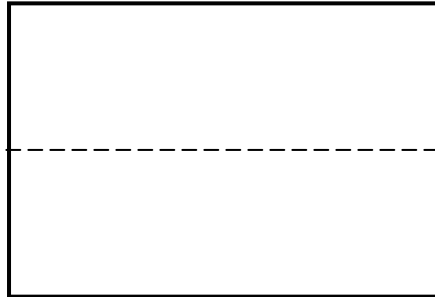
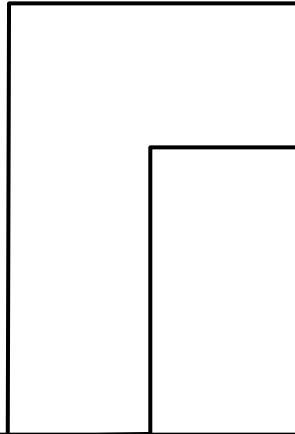
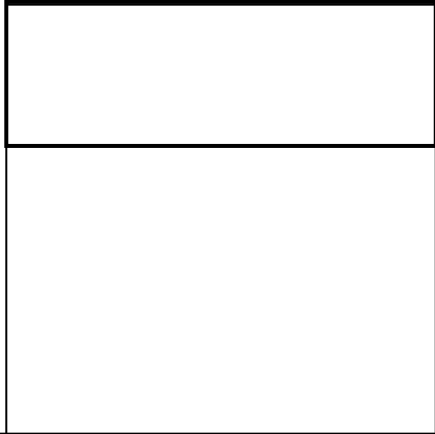

LT

FACHADA FRONTAL

+ PLANTA TECHOS

+ FACHADA LATERAL

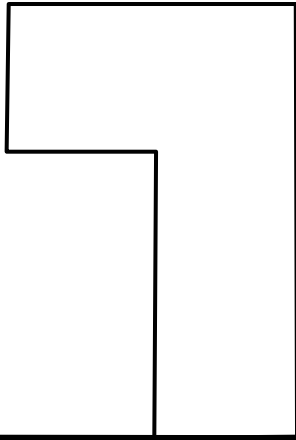

FACHADA LATERAL



FACHADA FRONTAL

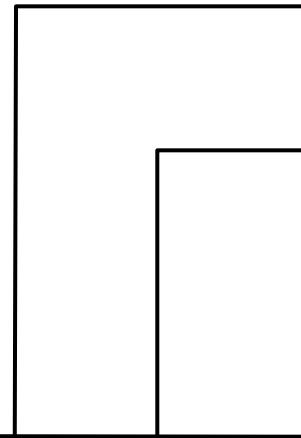

FACHADA LATERAL

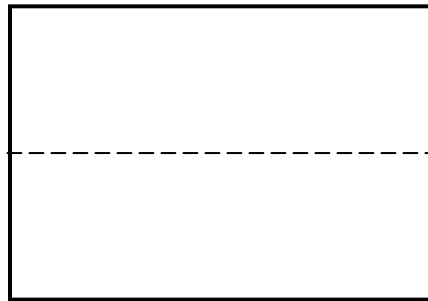

PLANTA TECHOS

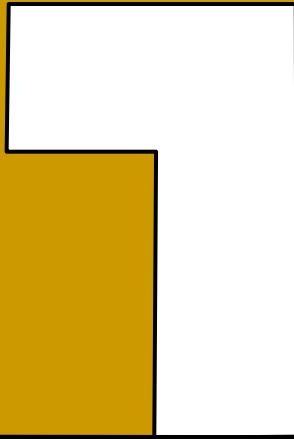

FACHADA LATERAL



FACHADA FRONTAL

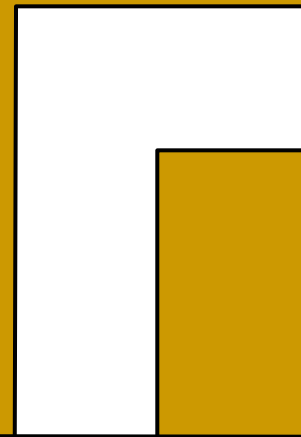

FACHADA LATERAL

LT

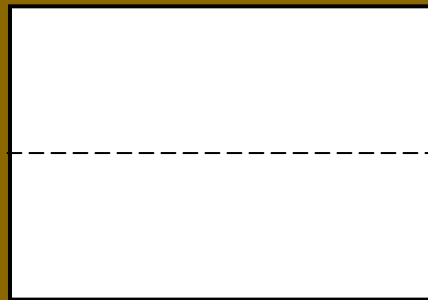

PLANTA TECHOS

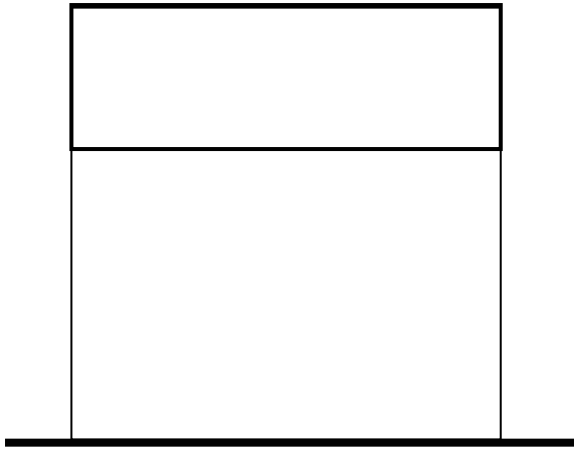

FACHADA FRONTAL

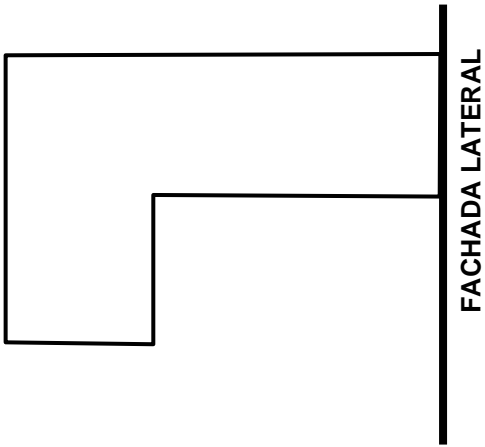

FACHADA LATERAL

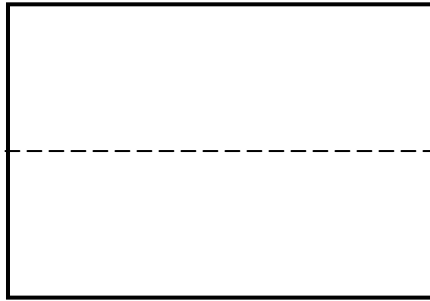

PLANTA TECHOS

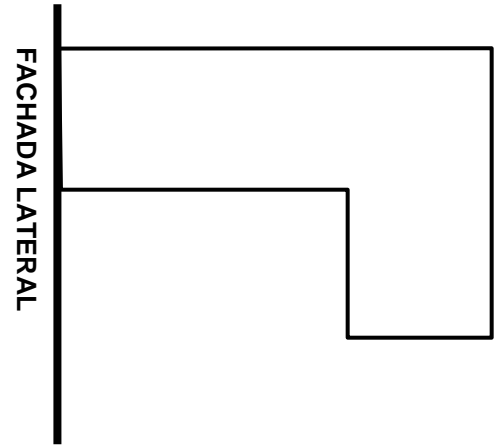

FACHADA LATERAL

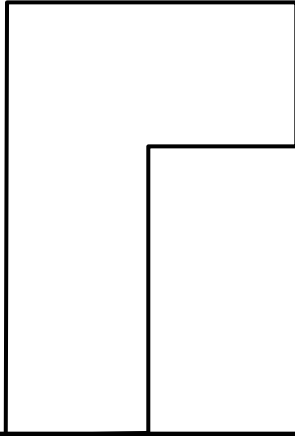
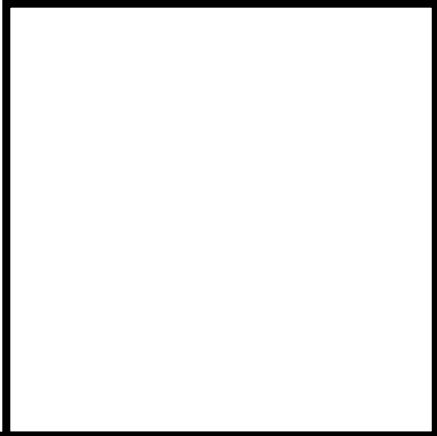

LT

CORTE 1

+ PLANTA TECHOS

+ FACHADA LATERAL

1

1

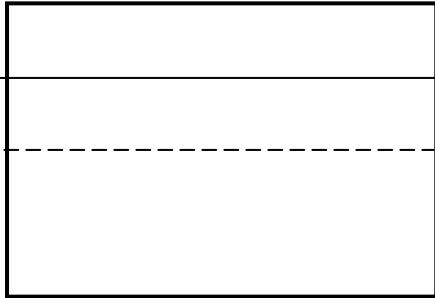

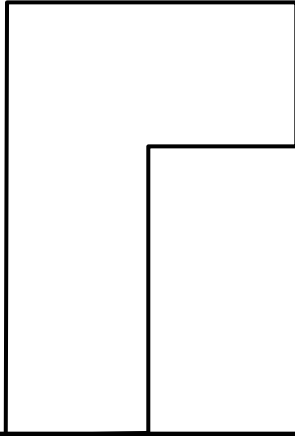
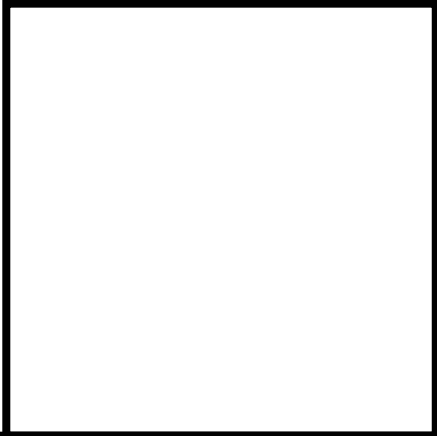

LT

CORTE 1

+ PLANTA TECHOS

+ FACHADA LATERAL

1

1

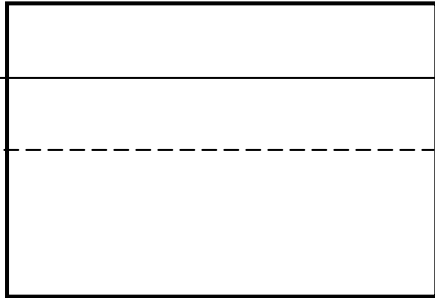

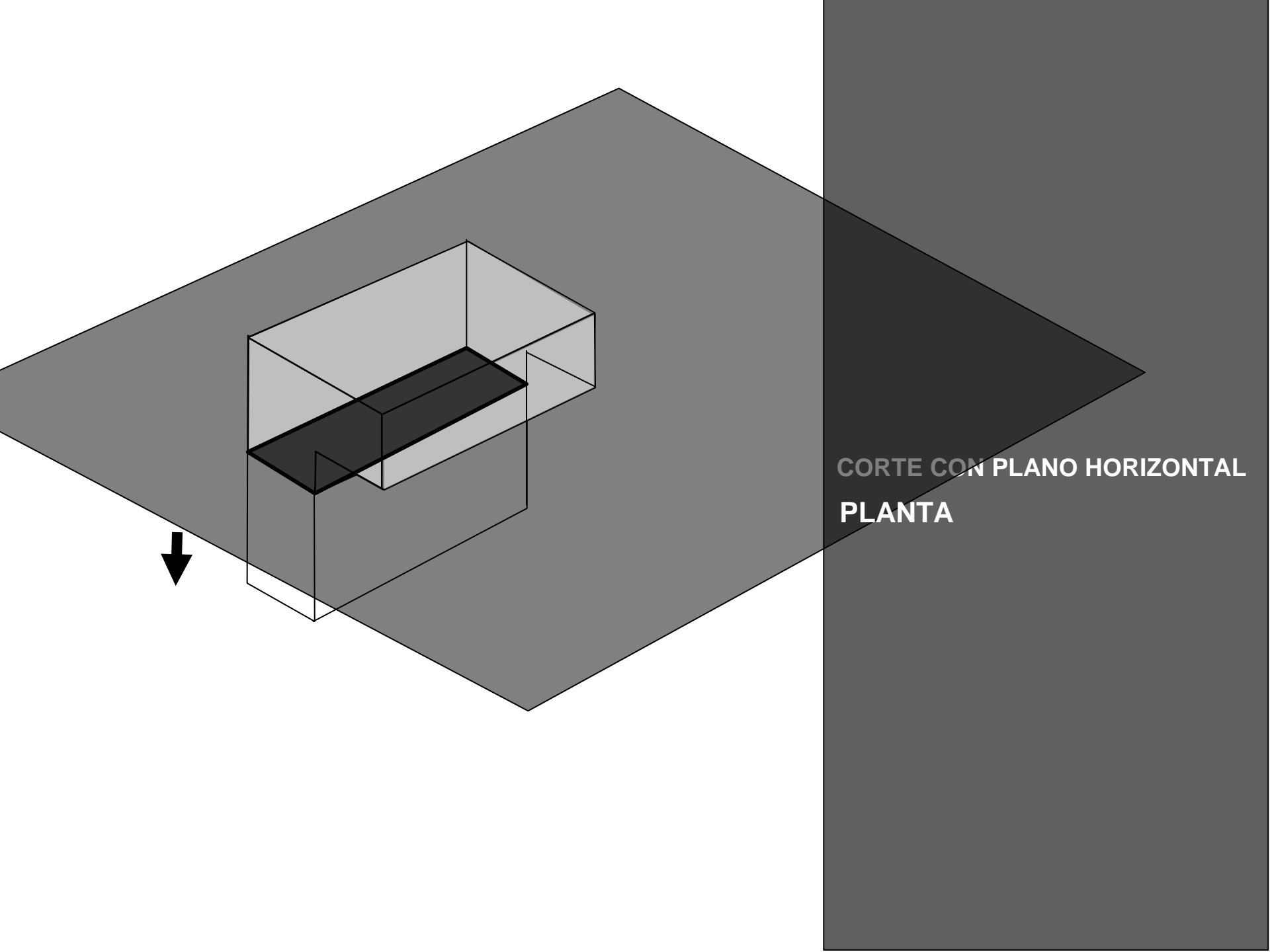

CORTE CON PLANO HORIZONTAL
PLANTA

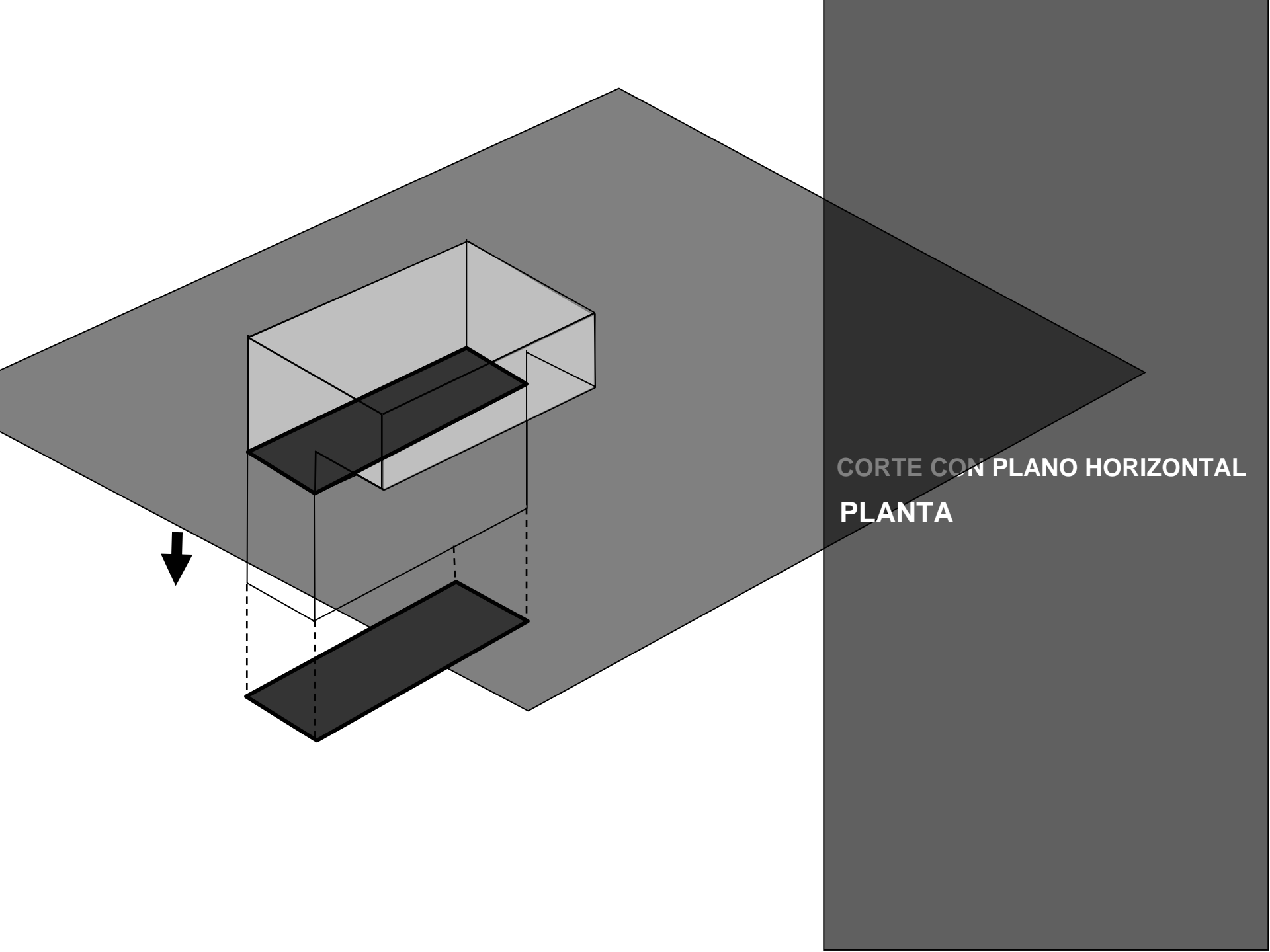

CORTE CON PLANO HORIZONTAL
PLANTA

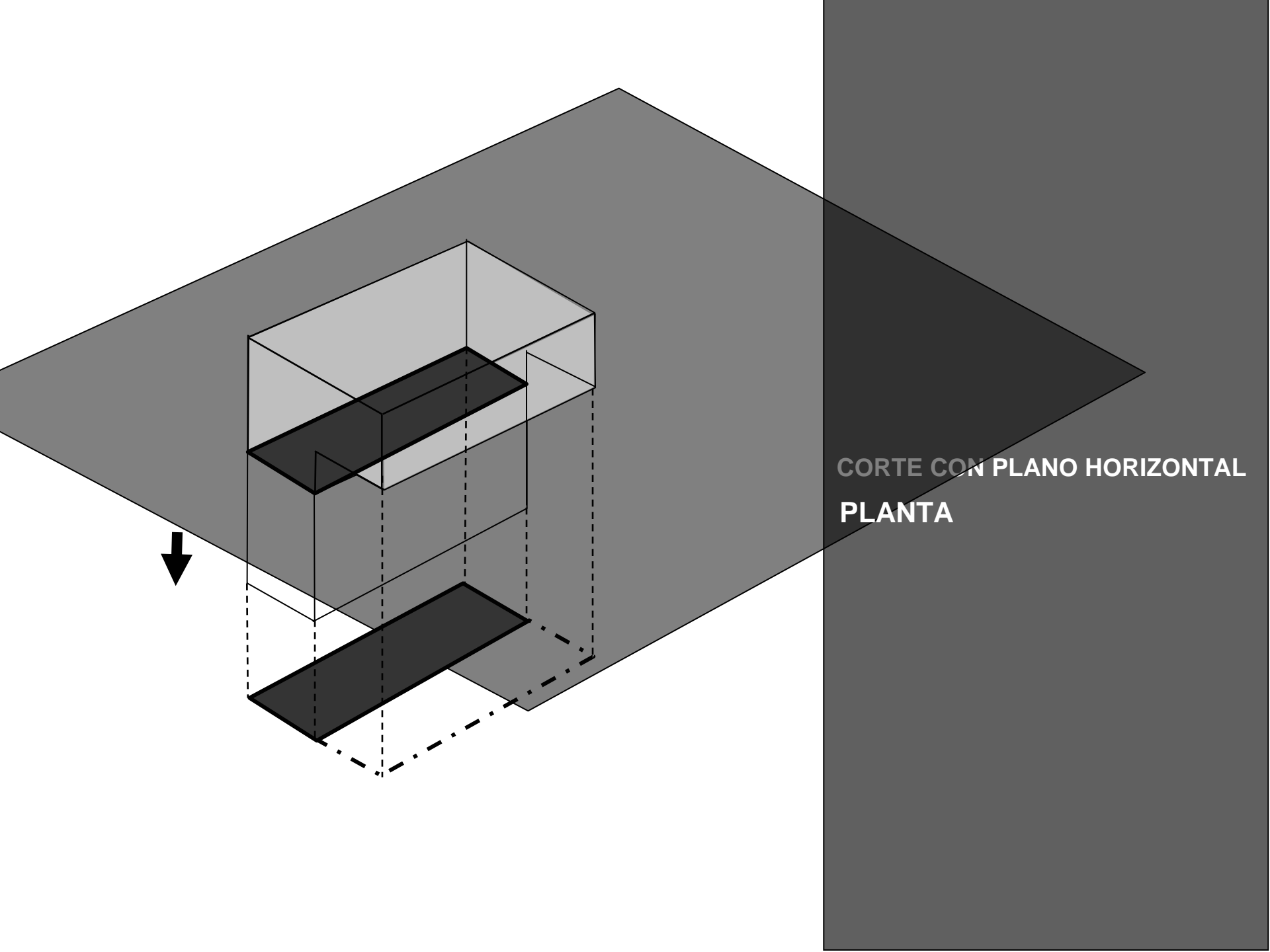

CORTE CON PLANO HORIZONTAL
PLANTA



FACHADA FRONTAL

FACHADA LATERAL



PLANTA NIVEL XXX

LT

FACHADA FRONTAL

+ PLANTA NIVEL XXX ó CORTE 3

+ FACHADA LATERAL

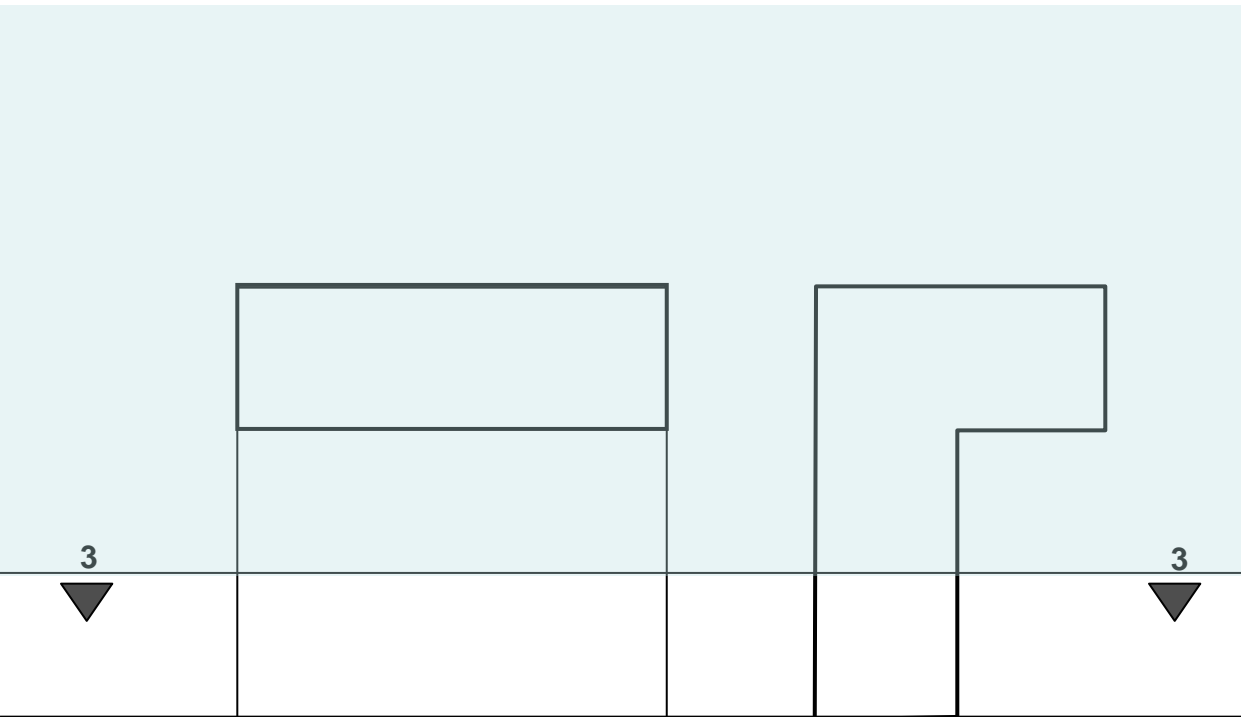

FACHADA FRONTAL

FACHADA LATERAL



PLANTA NIVEL XXX

LT





FACHADA FRONTAL

FACHADA LATERAL



PLANTA NIVEL XXX

LT



ESTRUCTURA GEOMÉTRICA SIN EXPRESIÓN

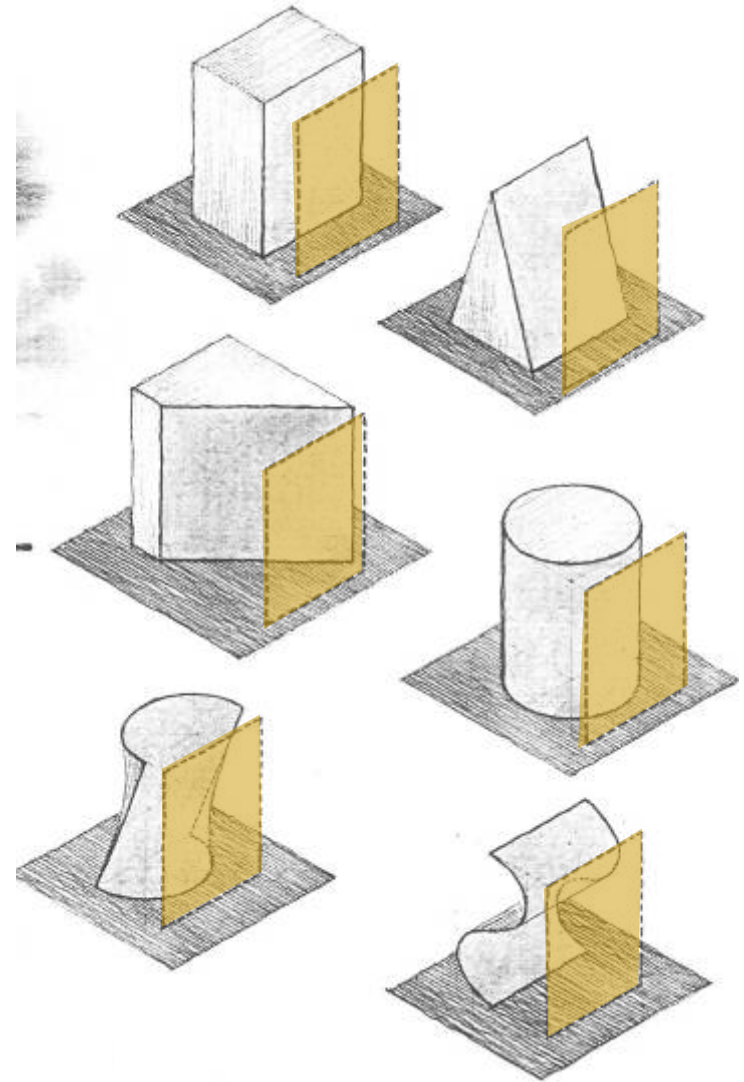
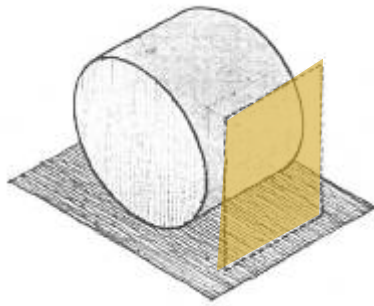
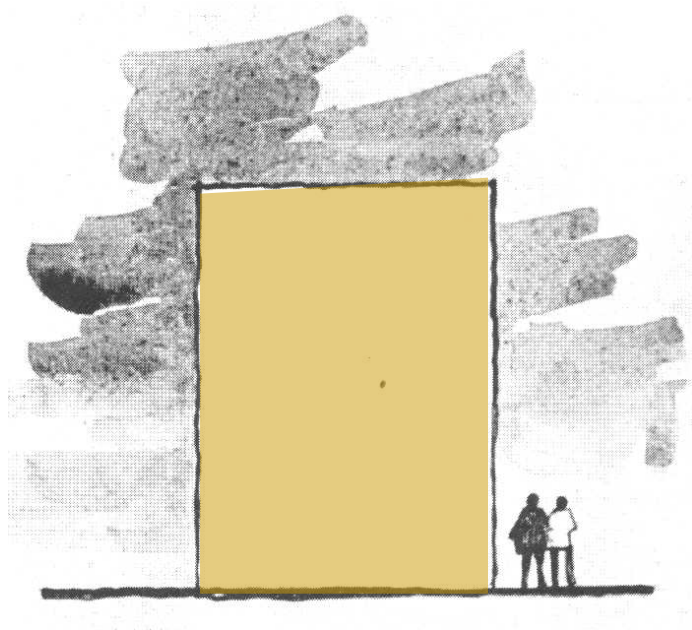

LT

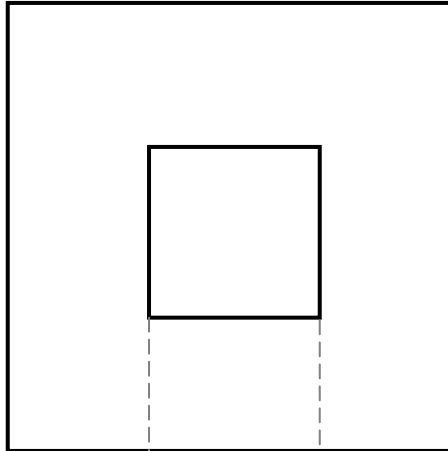

FACHADA

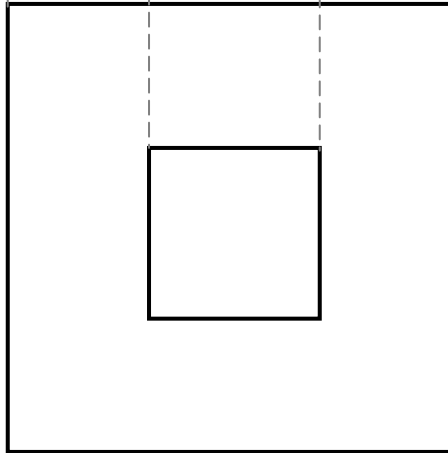

PLANTA

FOTOMONTAJE

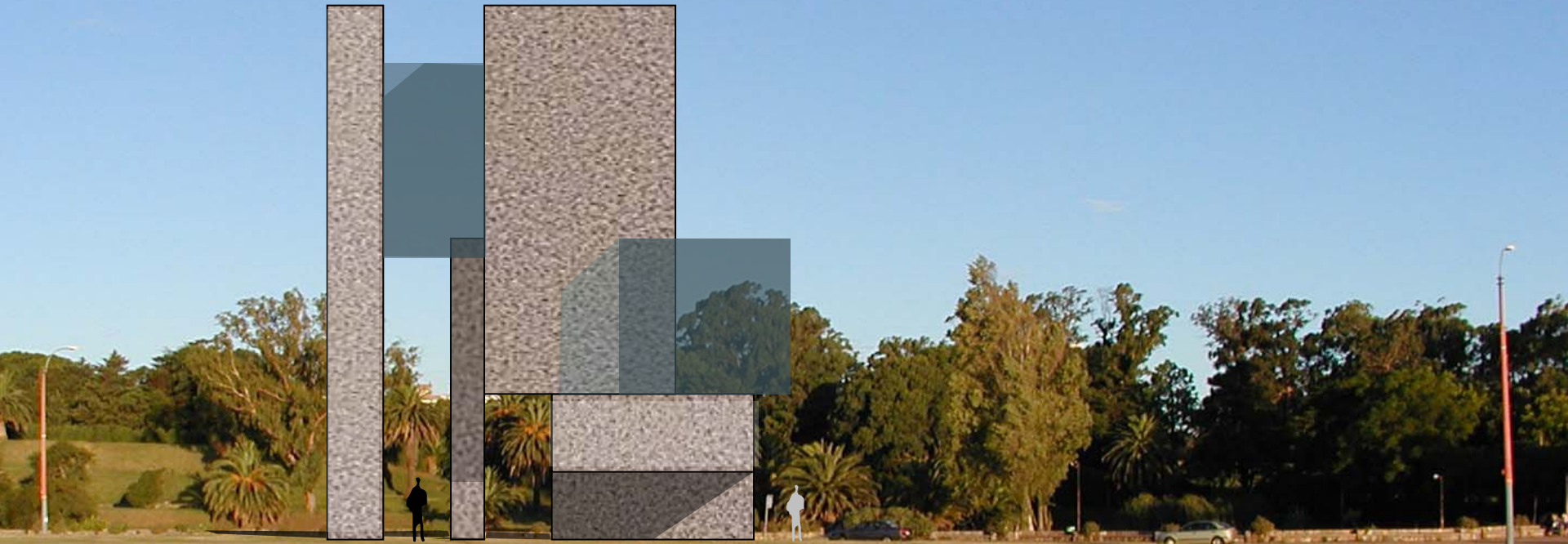

SDO fachada

FOTOMONTAJE



SDO corte

FOTOMONTAJE



SDO corte

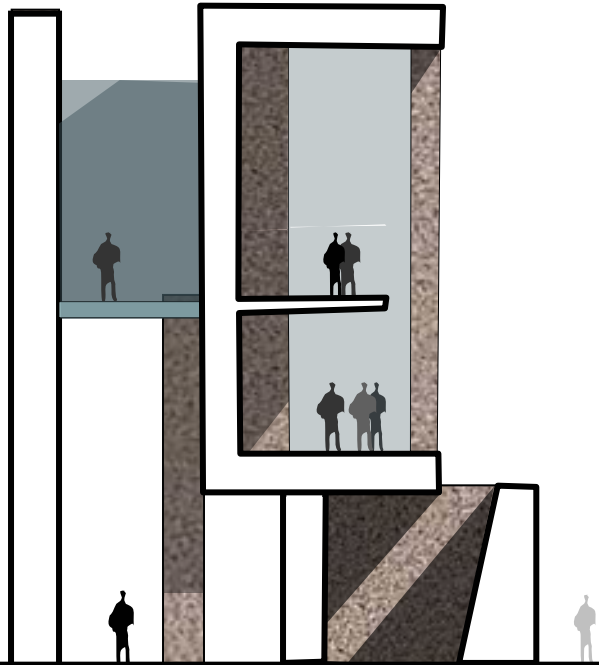

SDO corte

LT

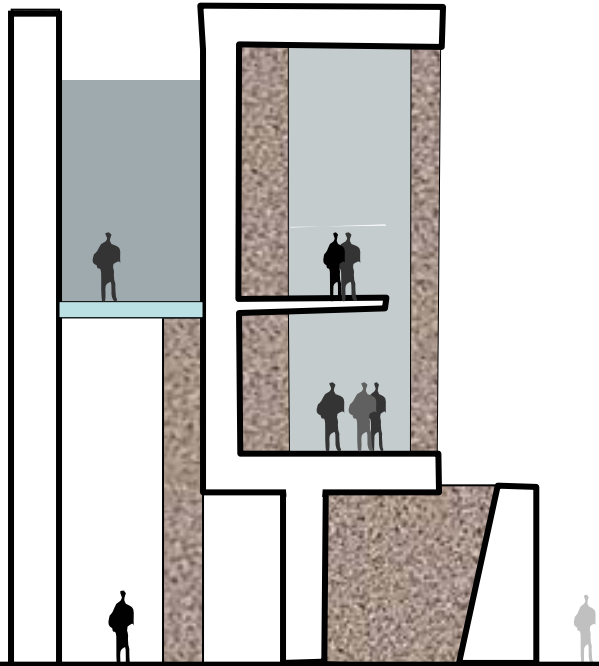

SDO corte

LT

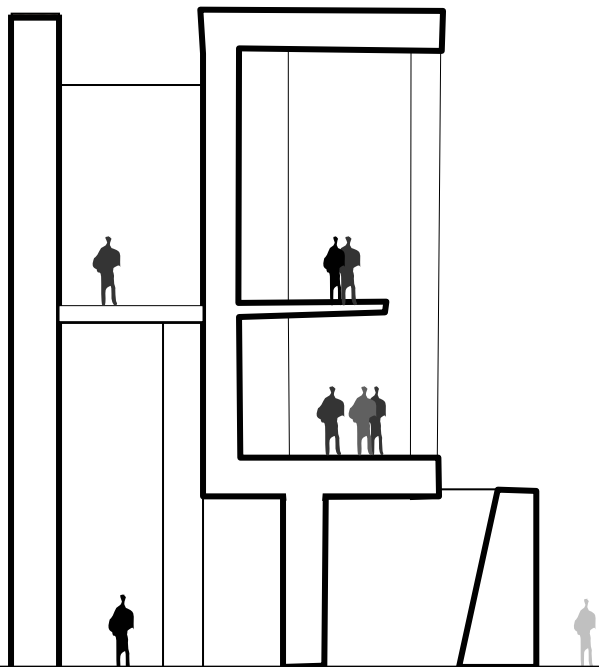

SDO corte

LT

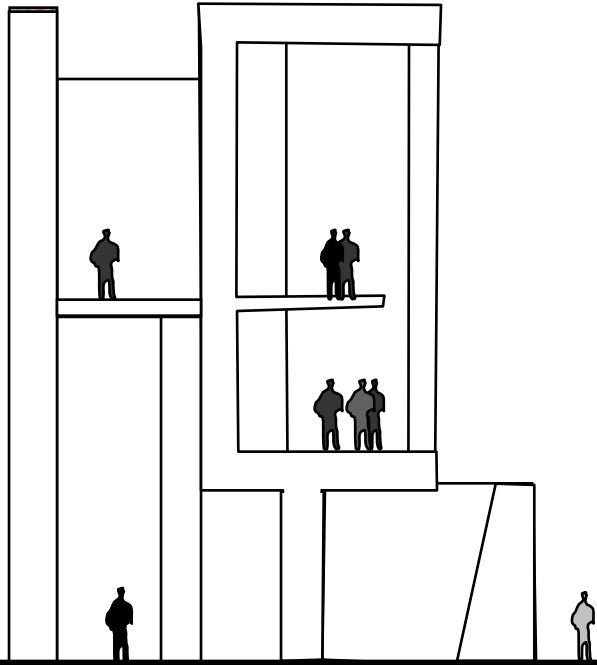

SDO corte

LT

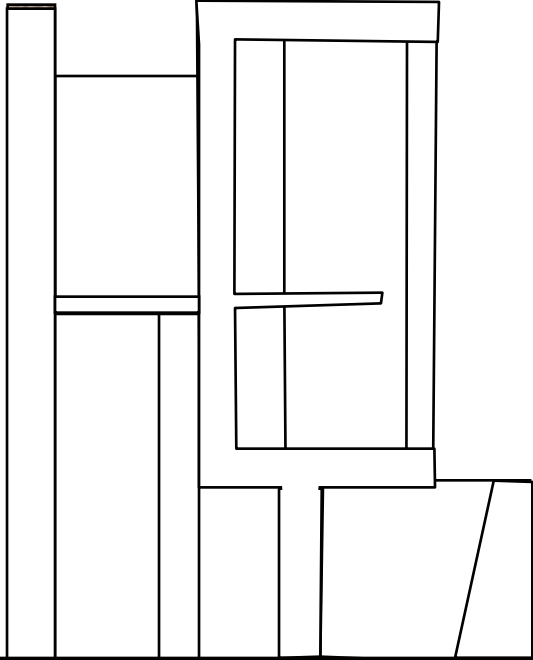

SDO corte

LT

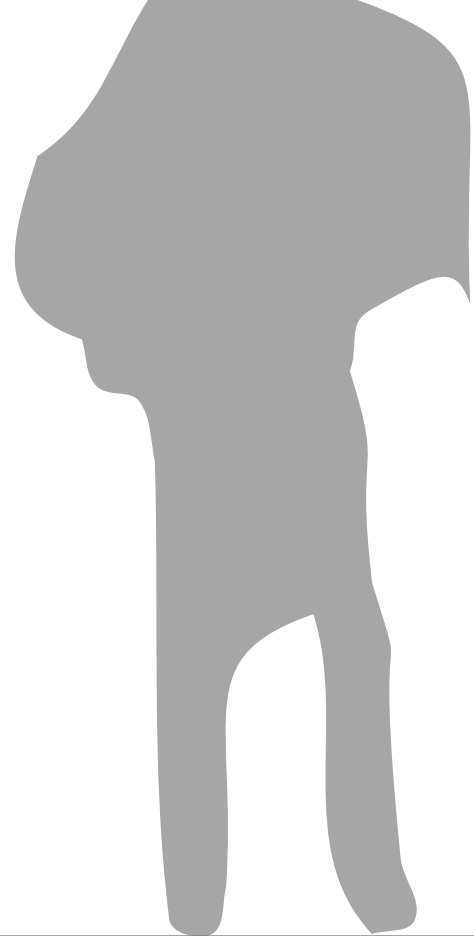
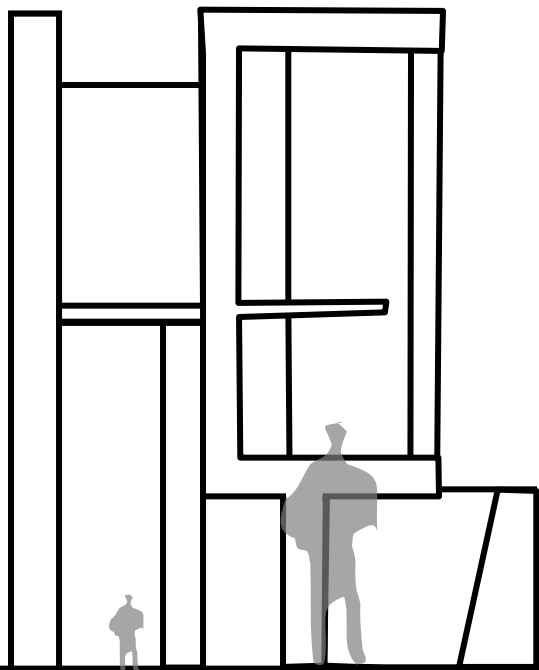

LT

SDO corte

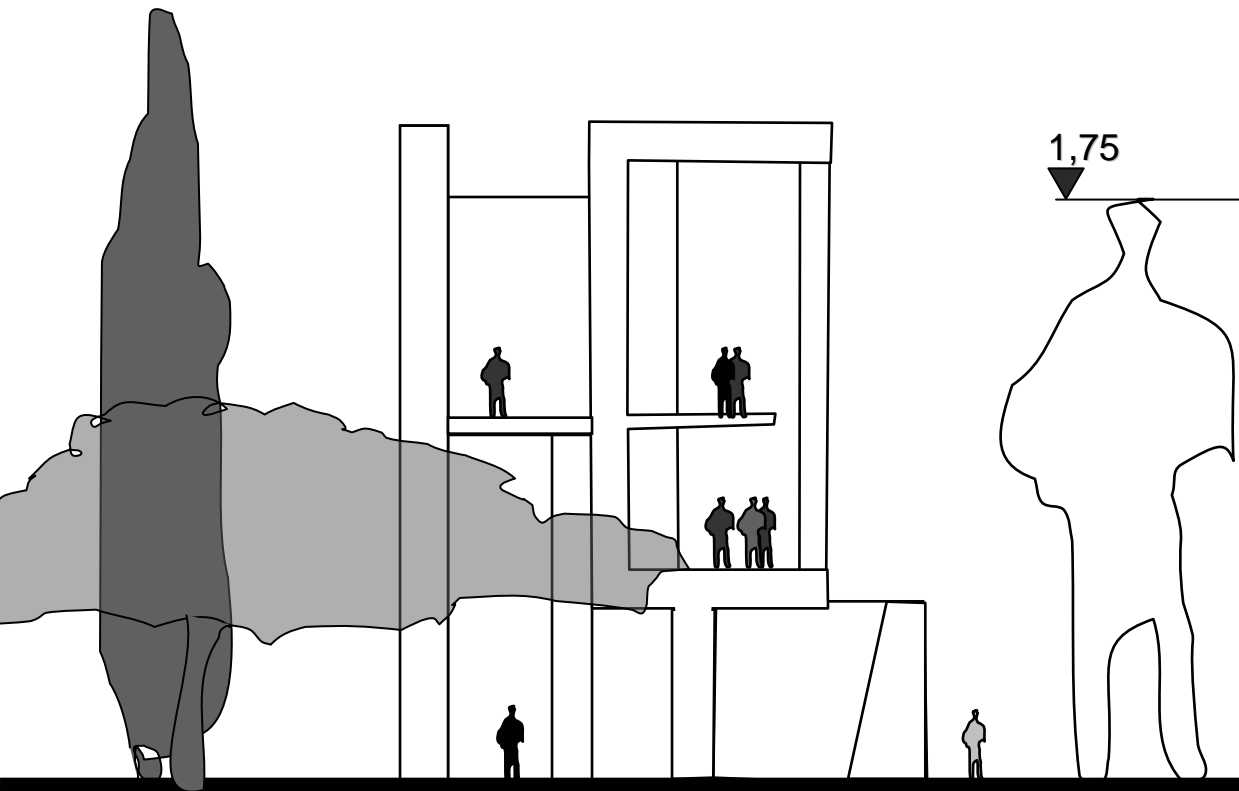

ESCALA

Permite relacionar el objeto con una unidad de medida

Escala "humana"
Es una forma **aproximada** de obtener las dimensiones del objeto mediante la comparación con otro objeto de dimensiones conocidas

SDO corte

ESCALA

Permite relacionar el objeto con una unidad de medida

Escala gráfica

Escala numérica

LT

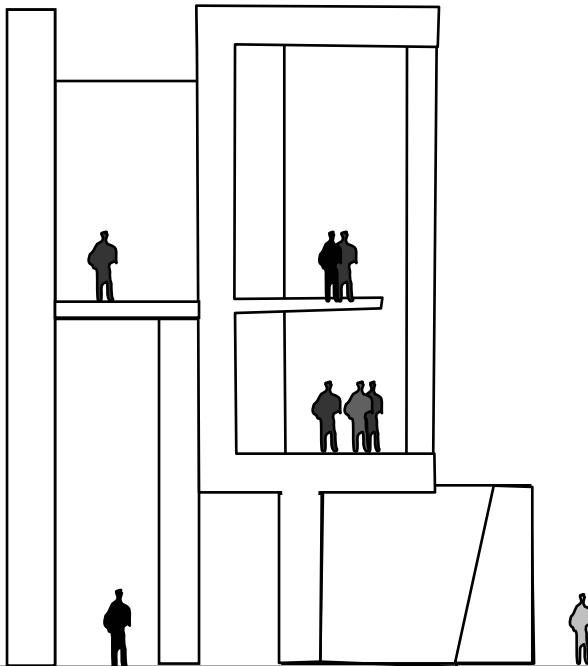

LT

SDO corte 1:200

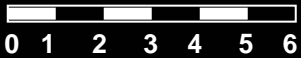

ESCALA numérica

imagen = escala x realidad

I (dibujo) = $E \times R$

1 cm = 1:200 x 200 cm

1 cm = $\frac{1}{200}$ x 200 cm

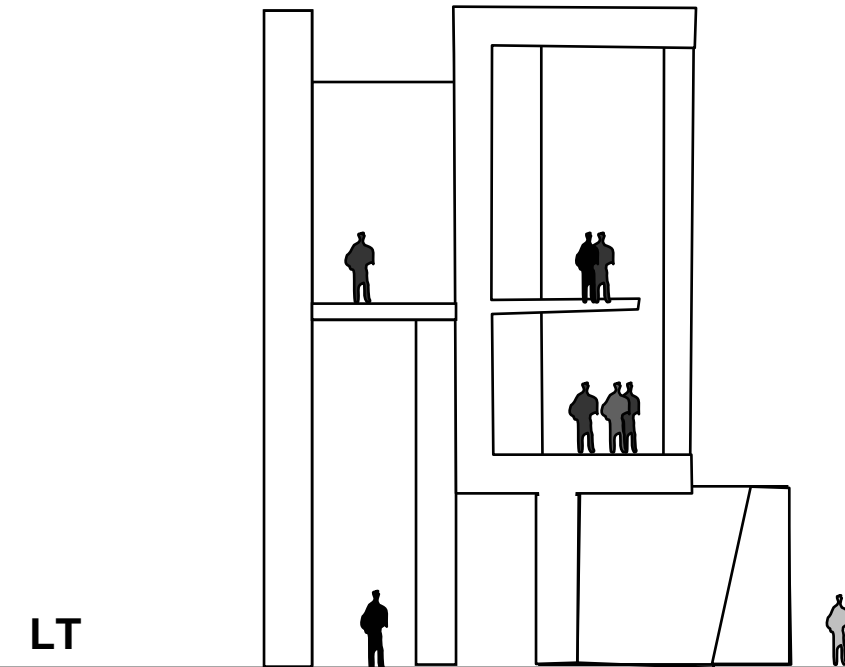

LT

LT

SDO corte 1:200

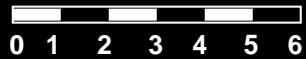

LT

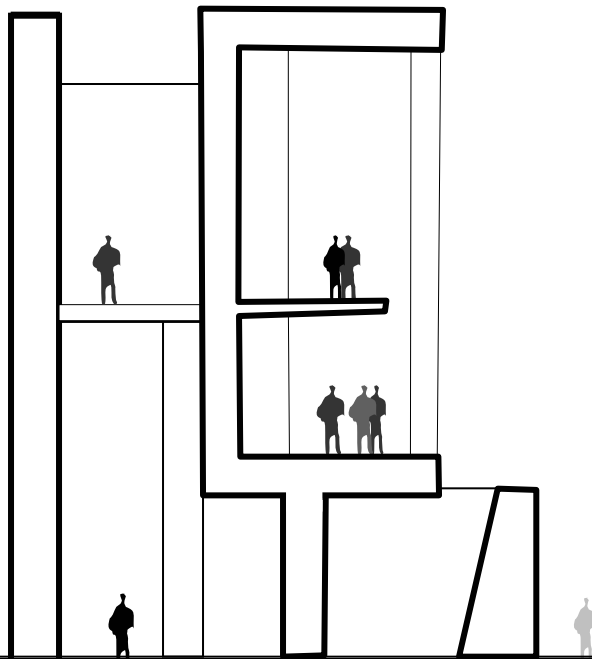

CORTE

Sección
Proyección
Trazo valorado

En el corte de un objeto hay una parte seccionada y otra proyectada.
Estas partes deben diferenciarse en la representación gráfica.

LT

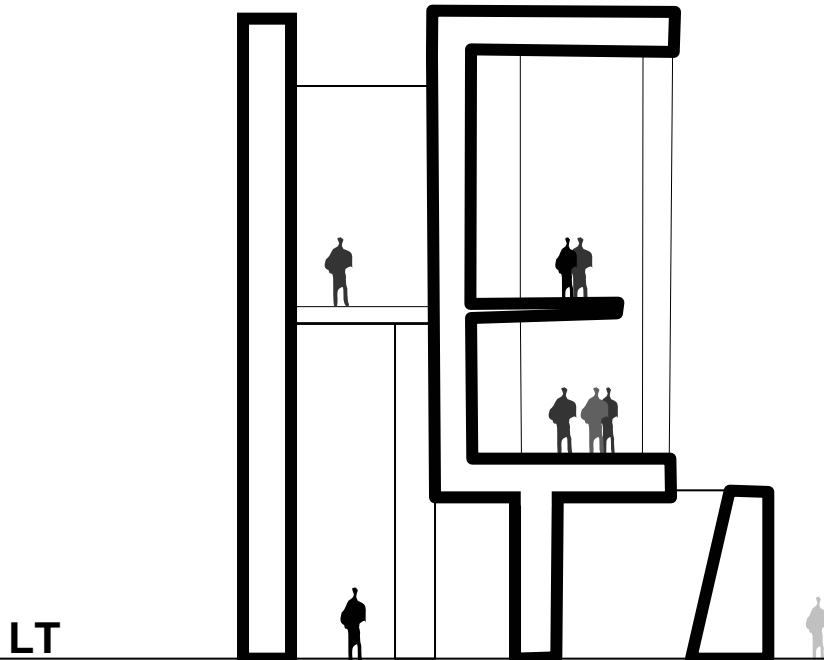

CORTE

Sección
Proyección
Trazo valorado

En el corte de un objeto hay una parte seccionada y otra proyectada.
Estas partes deben diferenciarse en la representación gráfica.

LT

LT

CORTE

Sección Proyección Sección pintada

En el corte de un objeto hay una parte seccionada y otra proyectada.
Estas partes deben diferenciarse en la representación gráfica.

LT

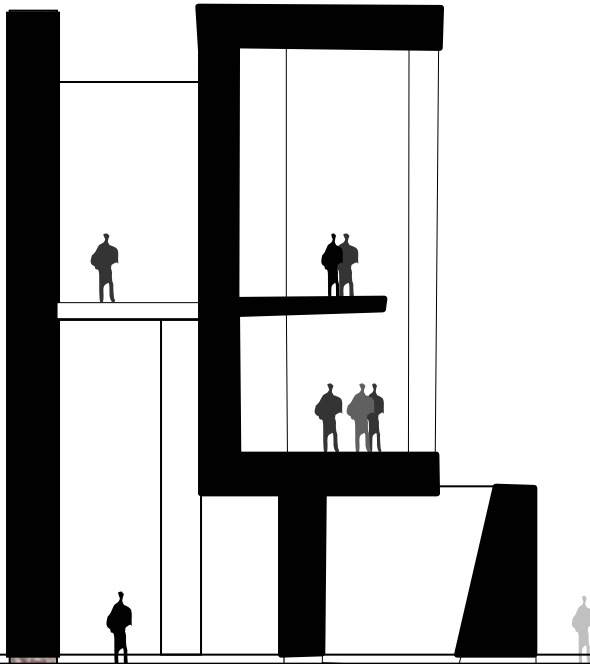

LT

SDO corte

CORTE

Sección Proyección Sección pintada

En el corte de un objeto hay una parte seccionada y otra proyectada.
Estas partes deben diferenciarse en la representación gráfica.

LT

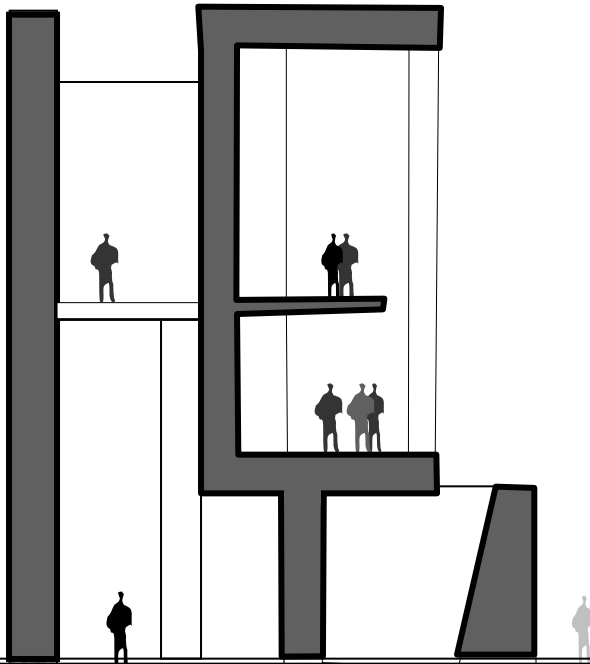

LT

SDO corte

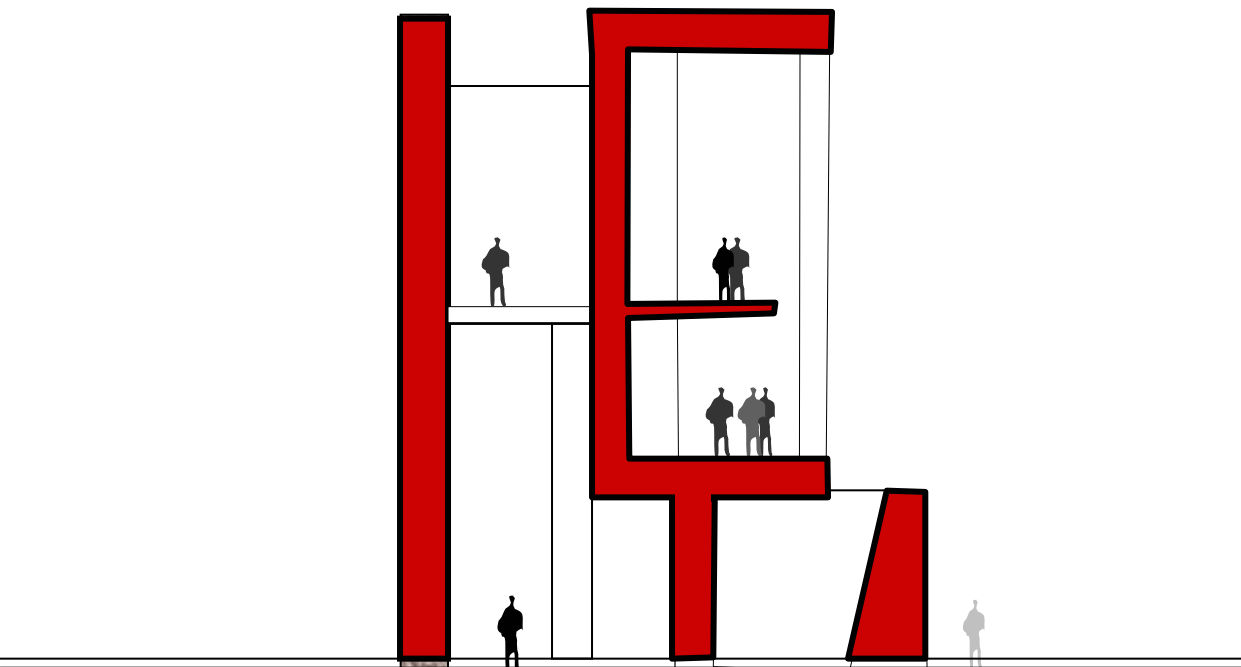

CORTE

**Sección
Proyección
Sección pintada**

En el corte de un objeto hay una parte seccionada y otra proyectada. Estas partes deben diferenciarse en la representación gráfica.

LT

SDO corte

CORTE

Sección
Proyección
Diferencia compositiva

En el corte de un objeto hay una parte seccionada y otra proyectada.
Estas partes deben diferenciarse en la representación gráfica.

LT

LT

SDO corte

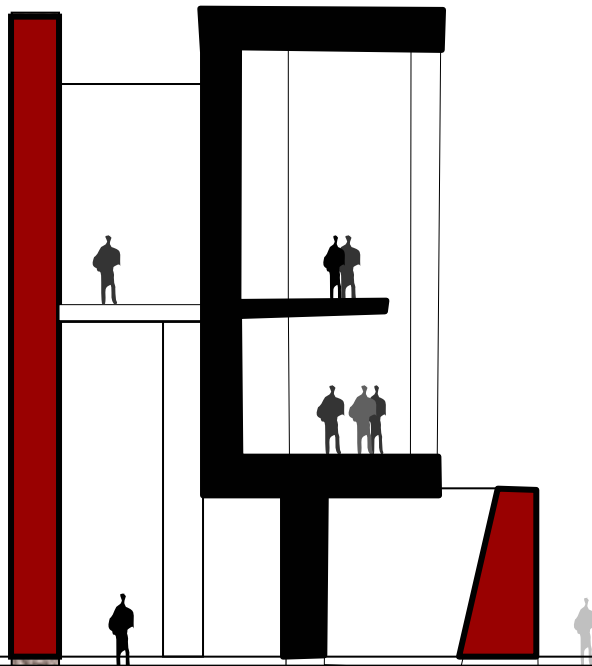

CORTE

Sección
Proyección
Diferencia de materiales

En el corte de un objeto hay una parte seccionada y otra proyectada.
Estas partes deben diferenciarse en la representación gráfica.

LT

LT

SDO corte

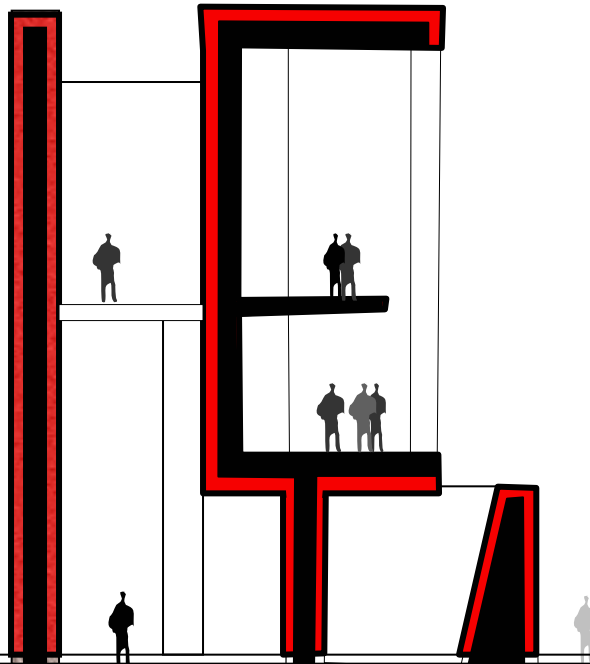

CORTE

Sección Proyección

En el corte de un objeto hay una parte seccionada y otra proyectada.
Estas partes deben diferenciarse en la representación gráfica.

LT

SDO corte

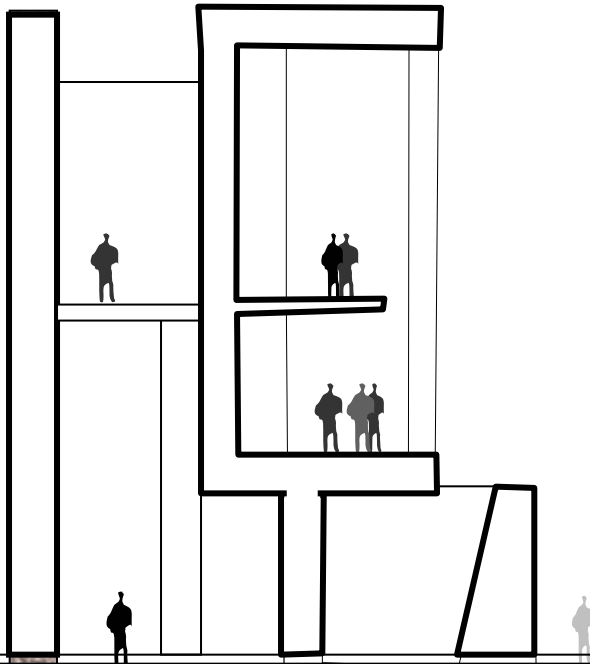

CORTE

Sección
Proyección
Trazo valorado

En el corte de un objeto hay una parte seccionada y otra proyectada.
Estas partes deben diferenciarse en la representación gráfica.

LT

SDO corte

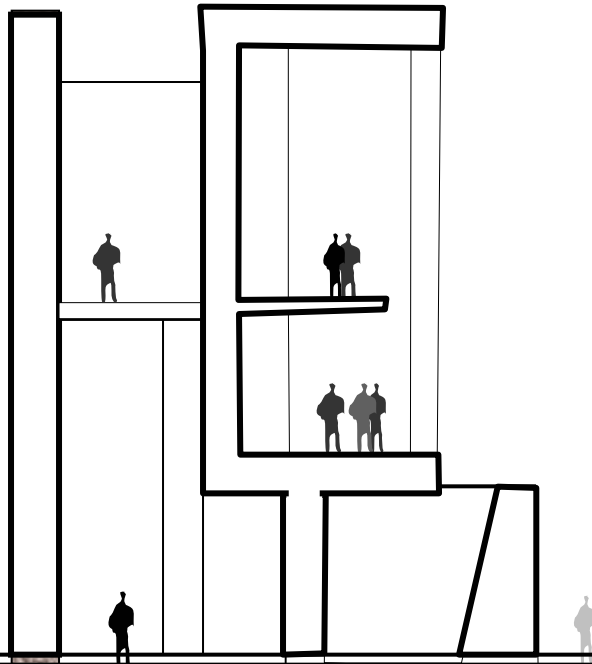

CORTE

Sección Proyección Fondo

En el corte de un objeto hay una parte seccionada y otra proyectada.
Estas partes deben diferenciarse en la representación gráfica.

LT

SDO corte

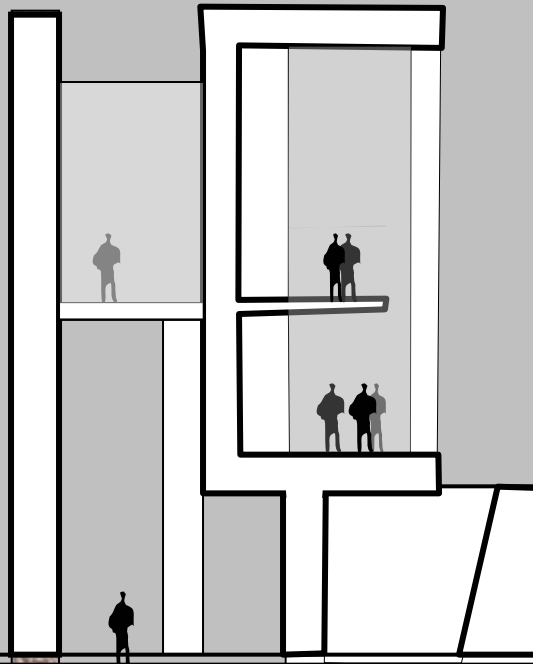

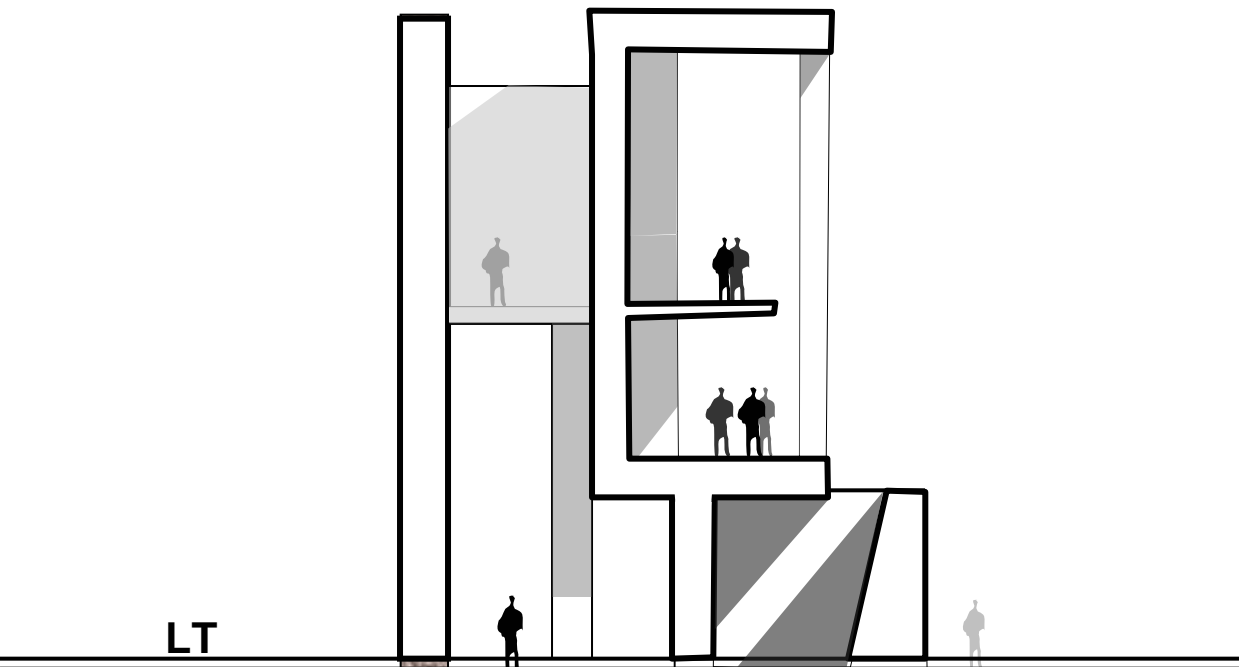

CORTE

Sección Proyección

En el corte de un objeto hay una parte seccionada y otra proyectada.

Estas partes deben diferenciarse en la representación gráfica.

LT
SDO corte

CORTE

Sección
Proyección
Sombras
Fondo

LT

SDO corte

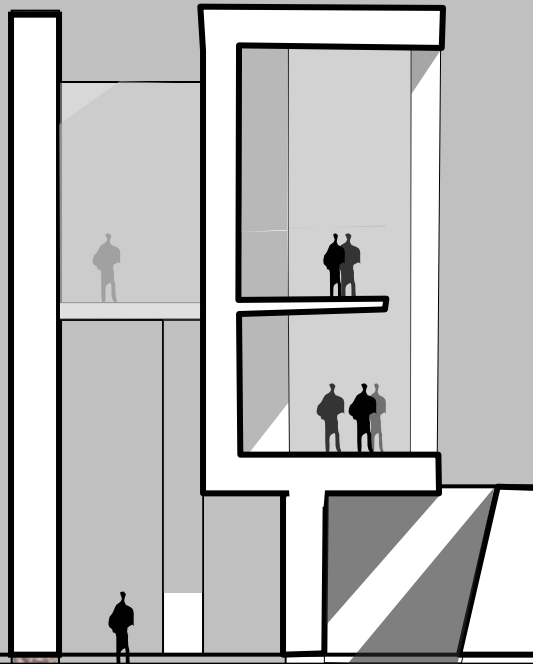

CORTE

Sección Proyección

En el corte de un objeto hay una parte seccionada y otra proyectada.

Estas partes deben diferenciarse en la representación gráfica.

LT

SDO corte

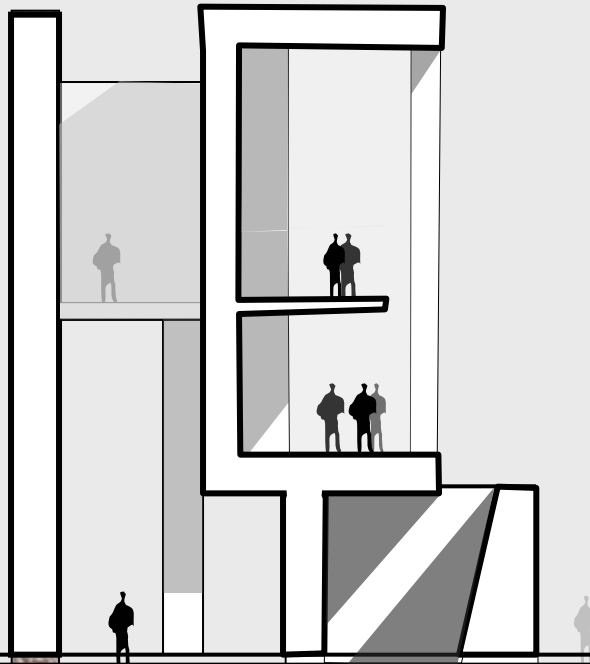

LT

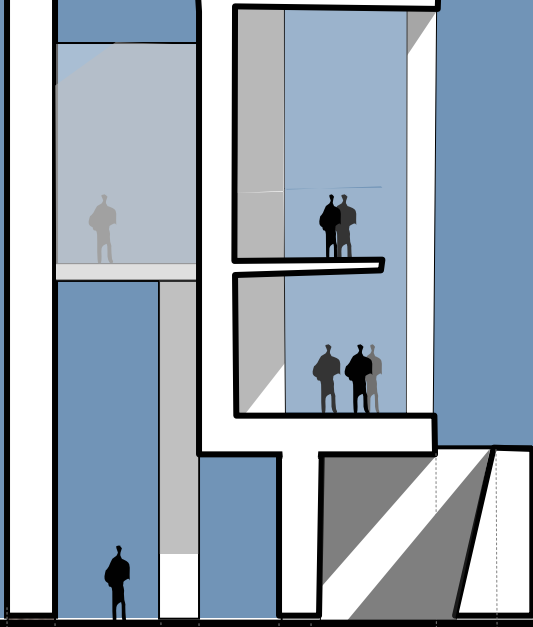

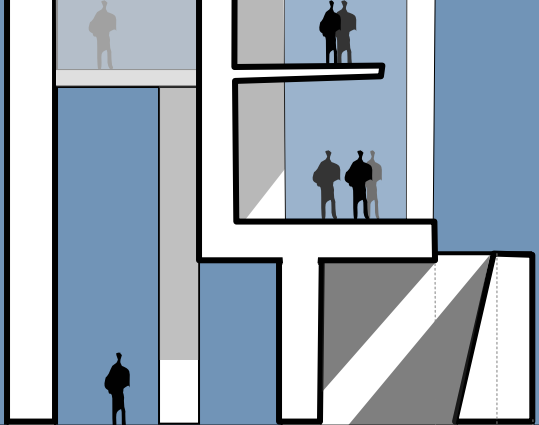

LT

CORTE 1

1

1

PLANTA TECHOS

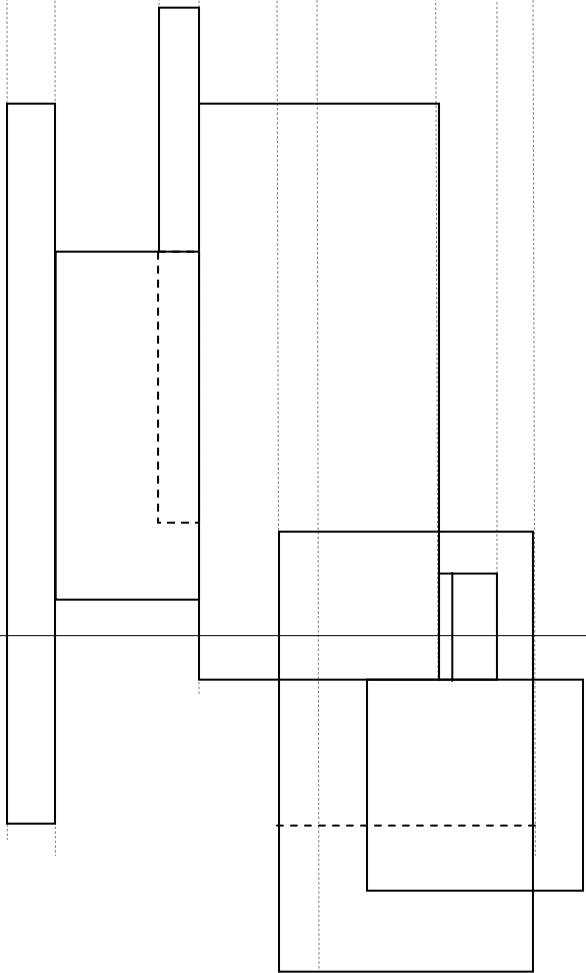

LT

CORTE 1

1

1

PLANTA TECHOS

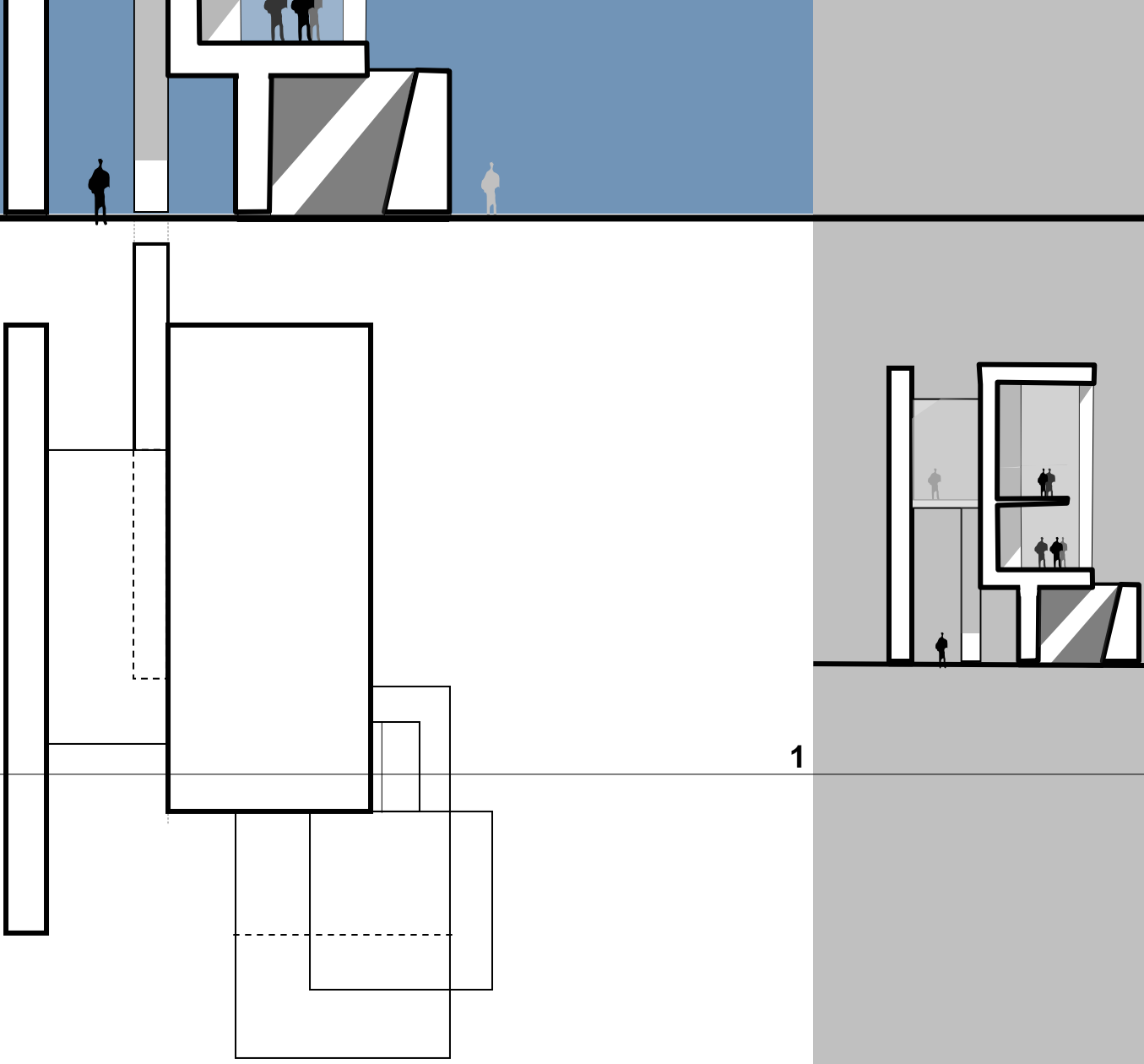

LT

CORTE 1

1

1

PLANTA TECHOS

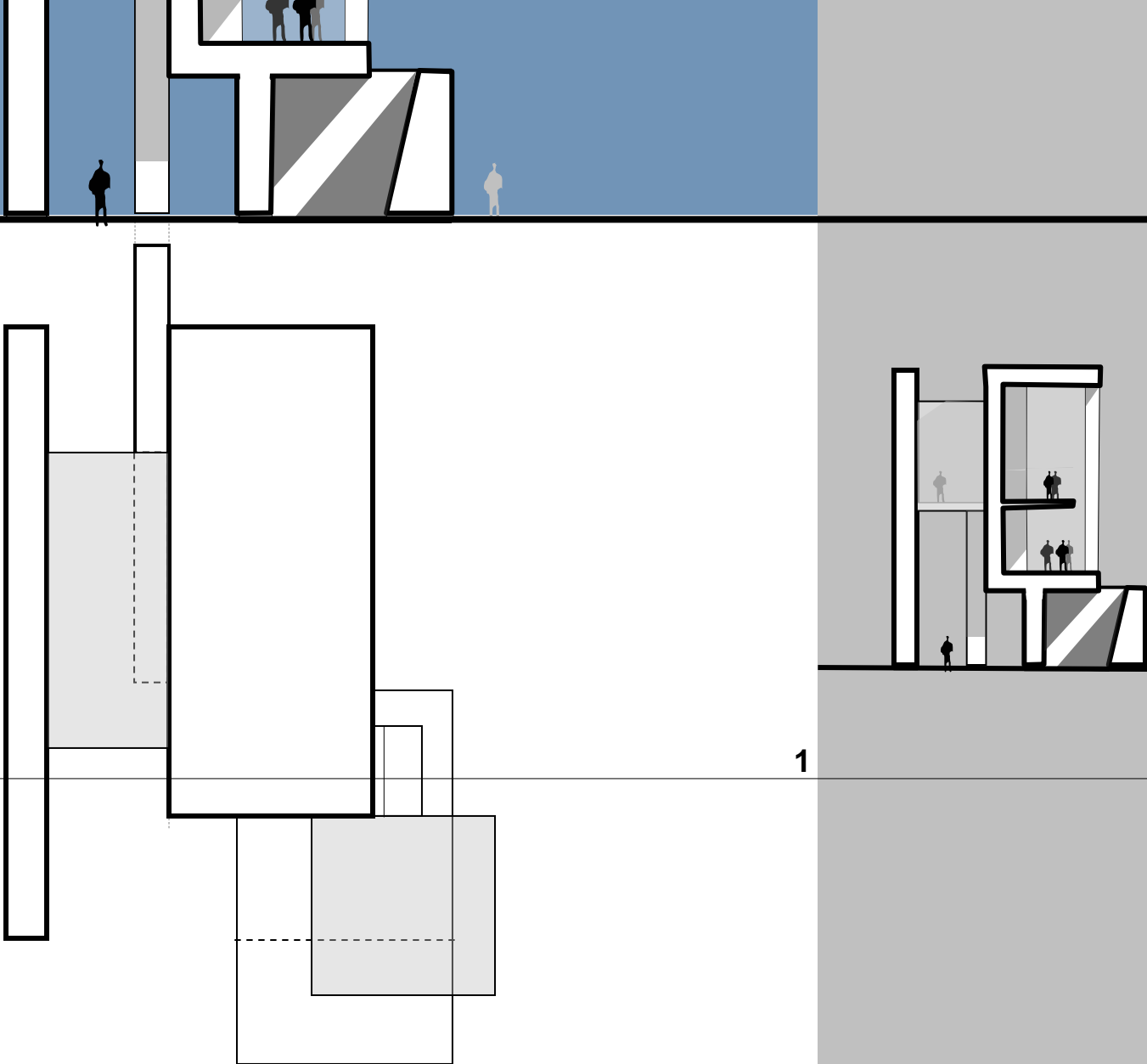

1

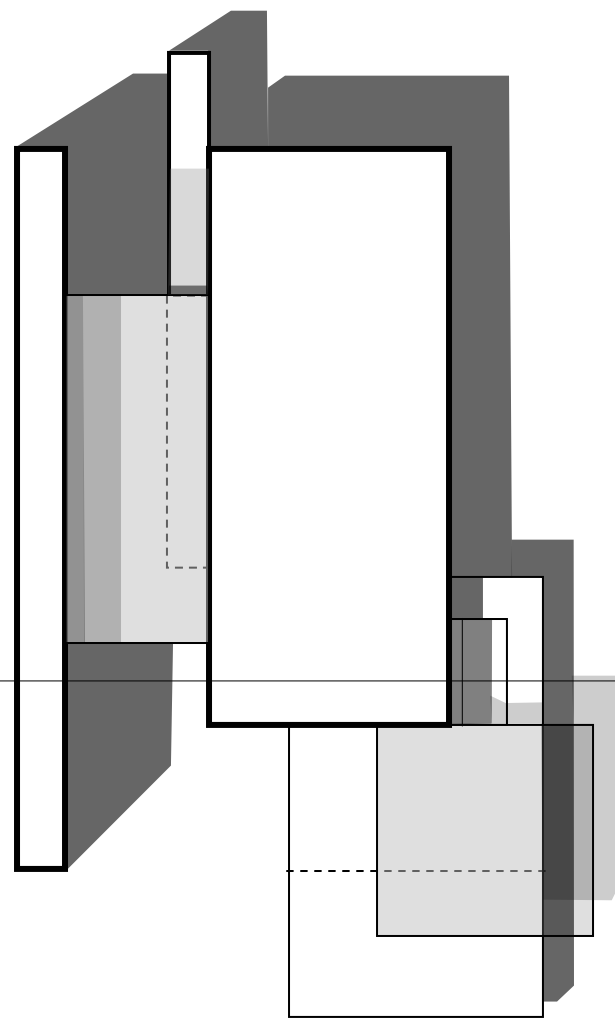

1

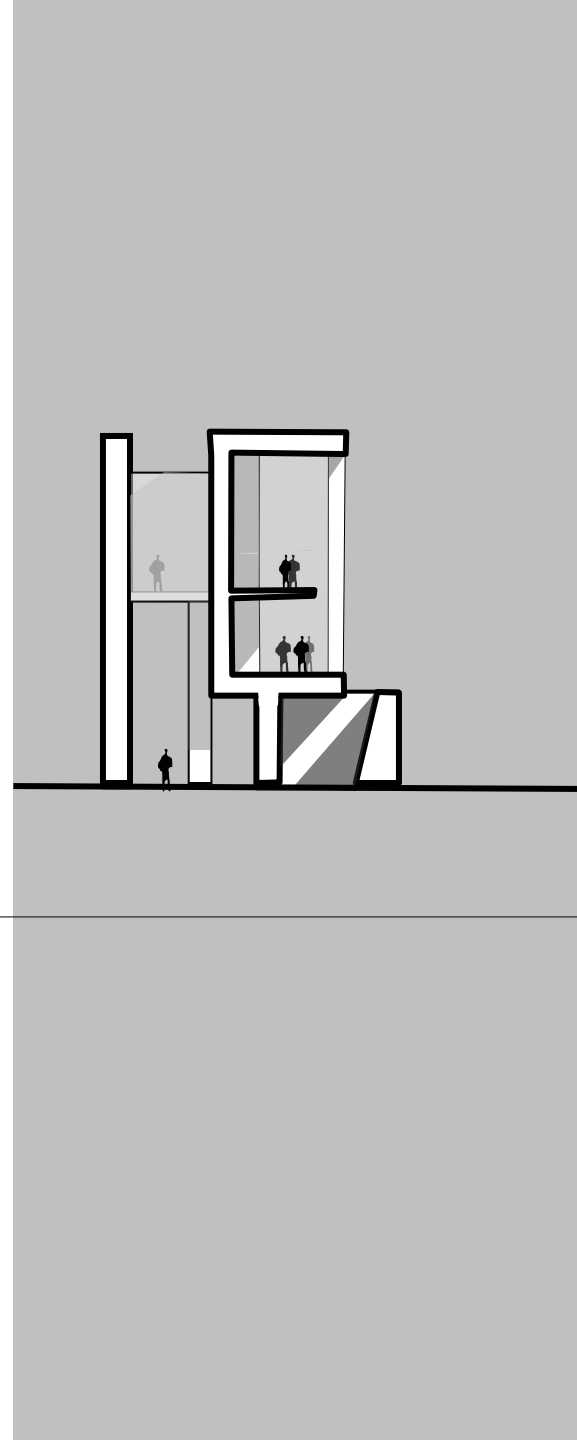

PLANTA TECHOS

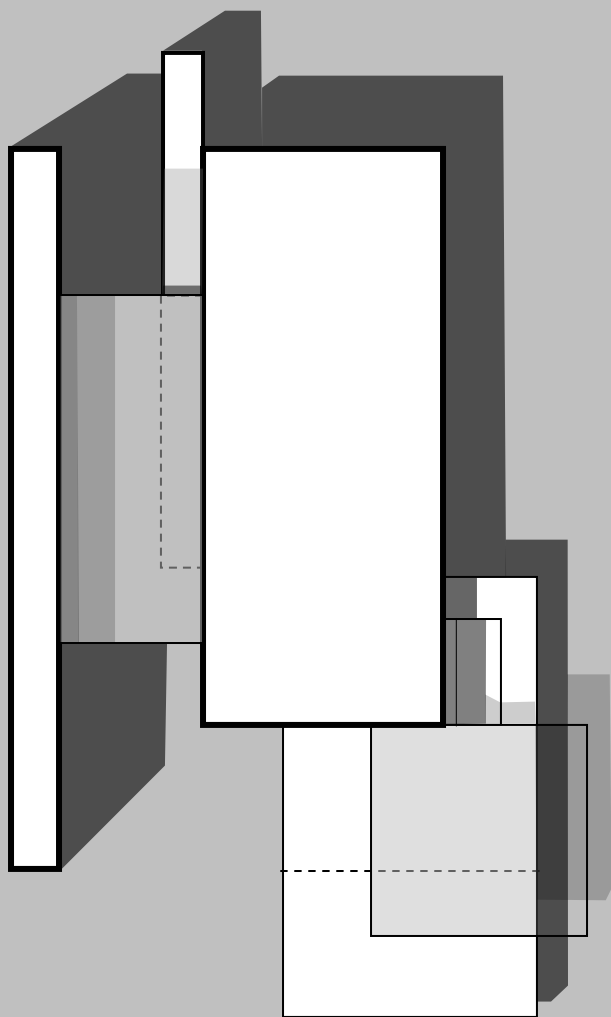

PLANTA TECHOS

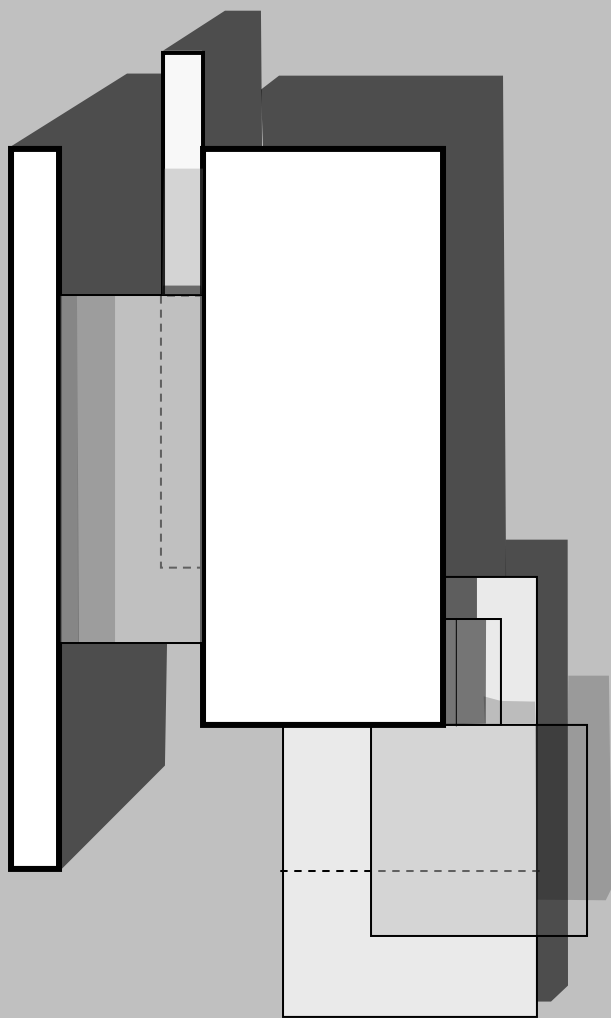

PLANTA TECHOS



fin