

MTE I

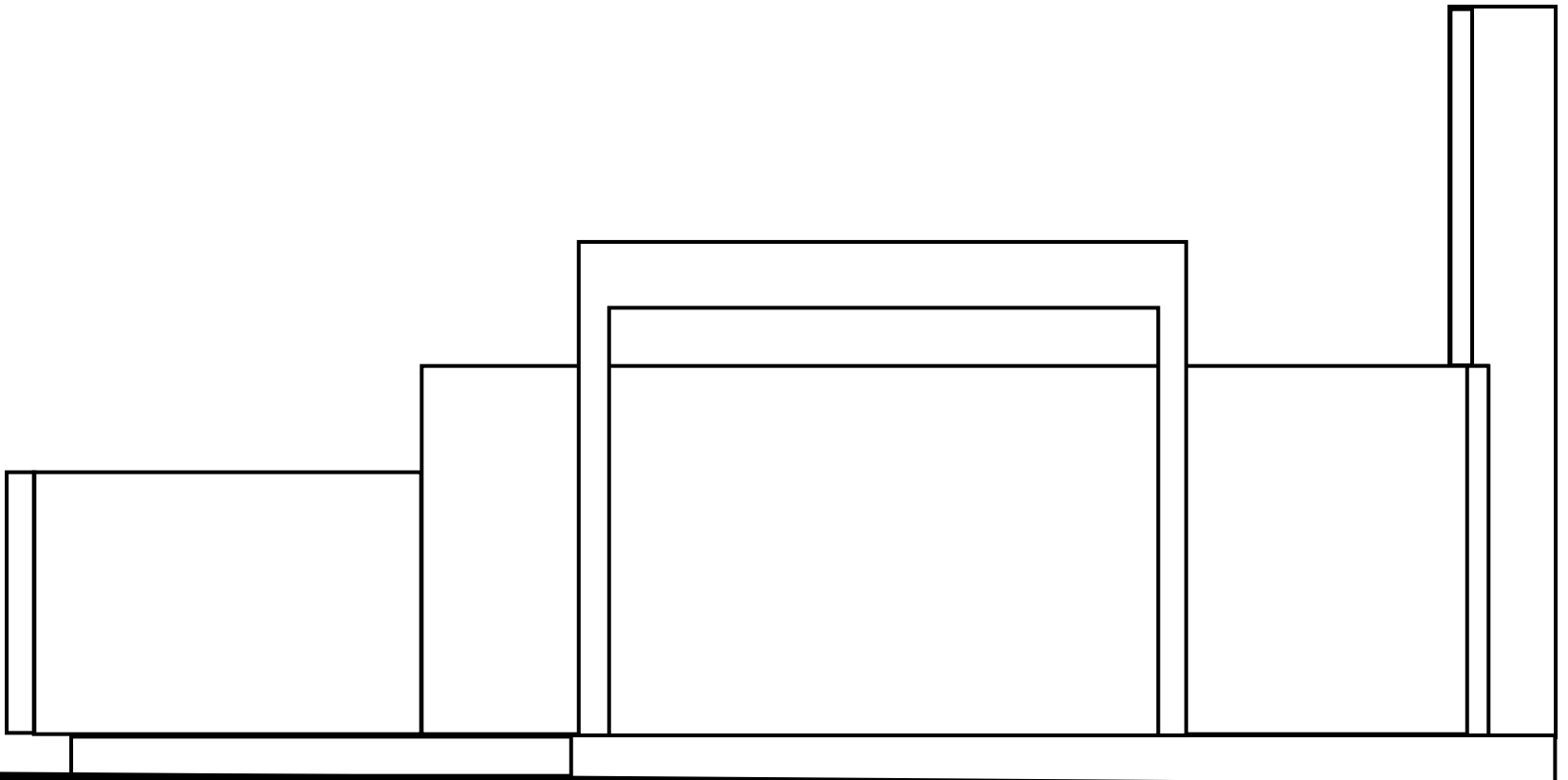

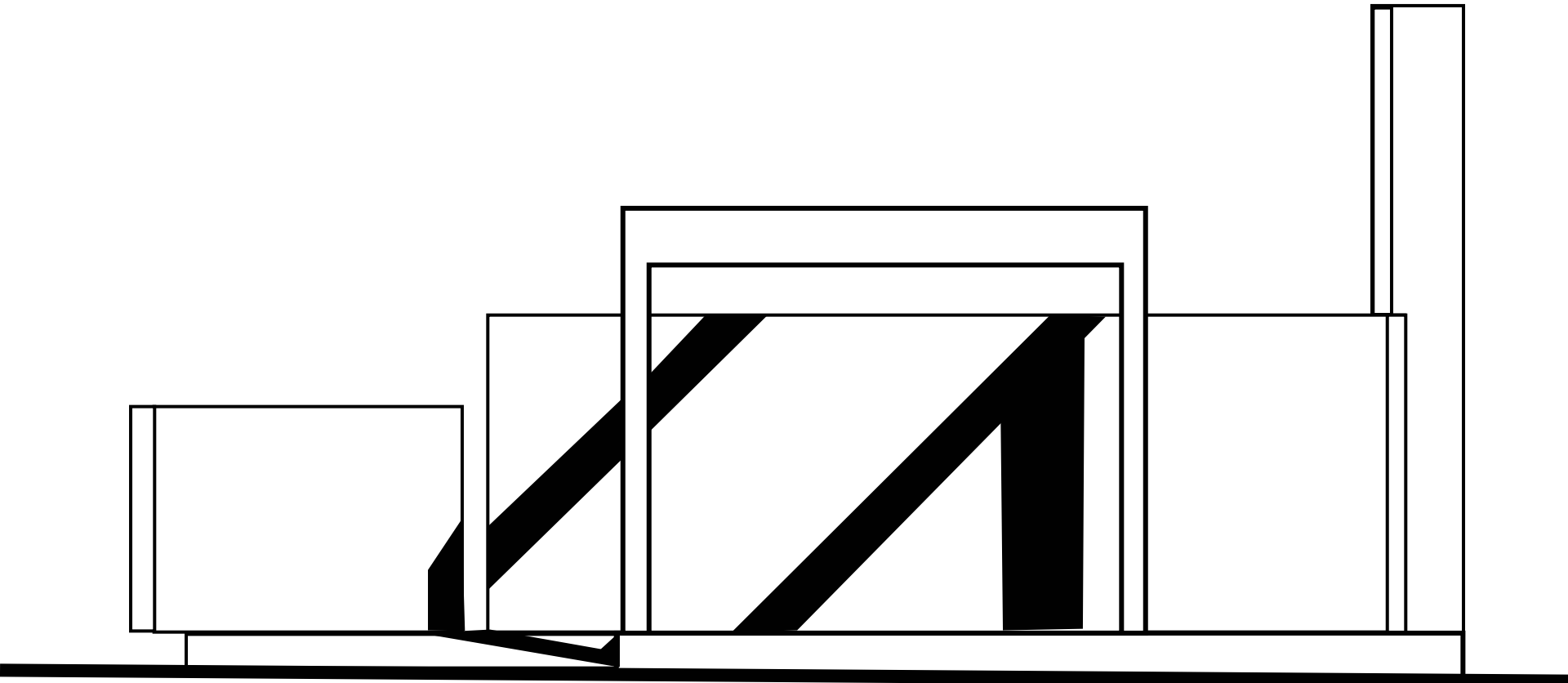

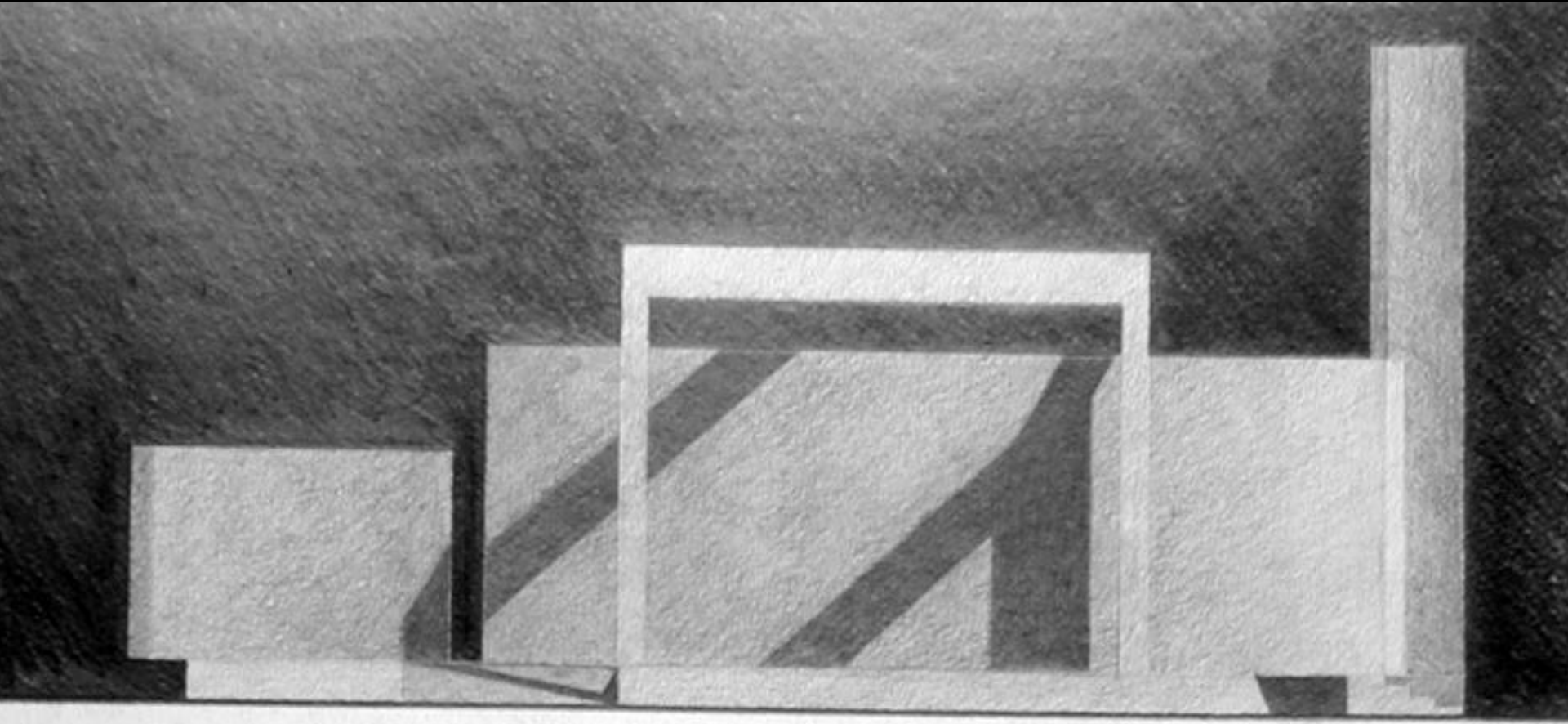

claroscuro



SOMBRAS PROPIAS

SOMBRAS ARROJADAS







PLANO DE LUZ Y SOMBRA

**CONTIENE TODOS LOS RAYOS
QUE PASAN POR LOS PUNTOS
DEL OBJETO**

**SU INTERSECCIÓN CON OTRO
OBJETO ES LA SOMBRA
ARROJADA SOBRE EL
OTRO OBJETO**

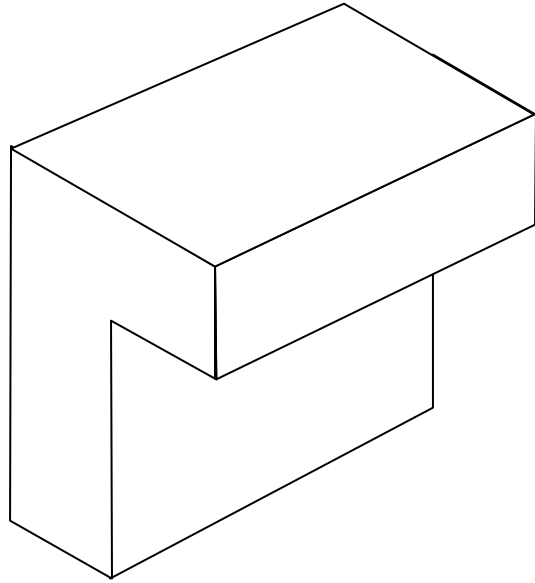

FOCO LUMINOSO NATURAL

**AXONOMETRÍA
SOMBRAS**

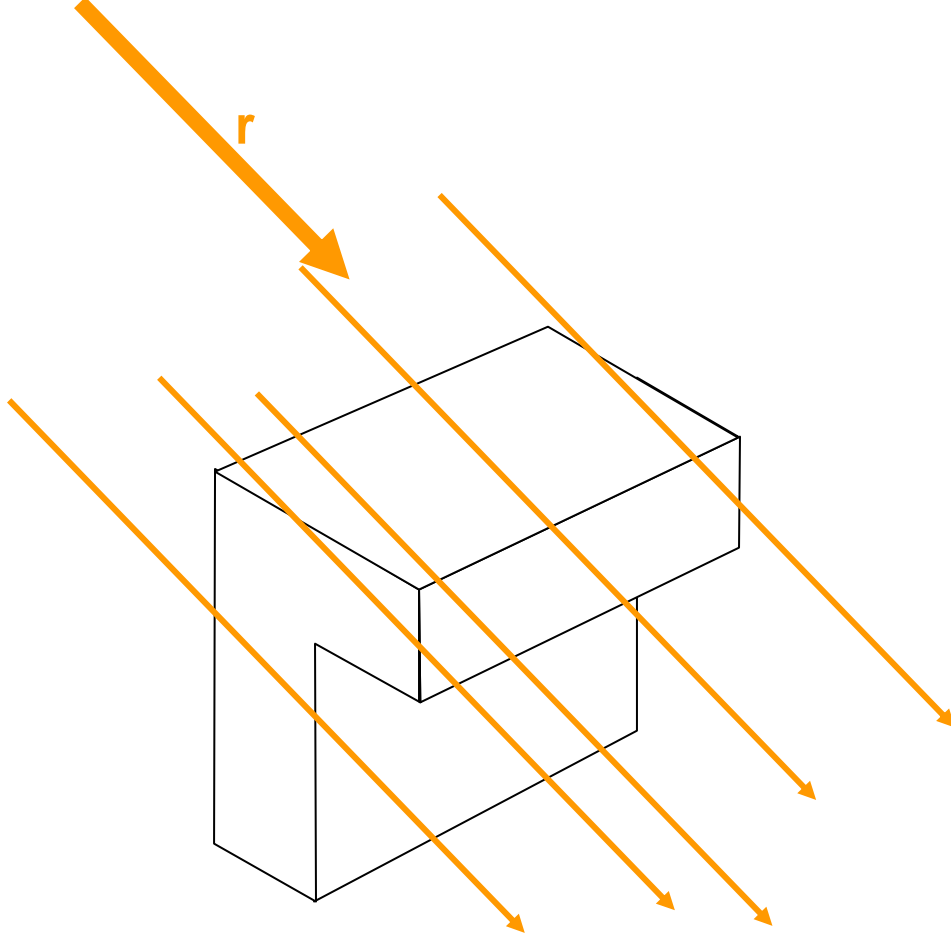

FOCO LUMINOSO NATURAL

**AXONOMETRÍA
SOMBRAS**

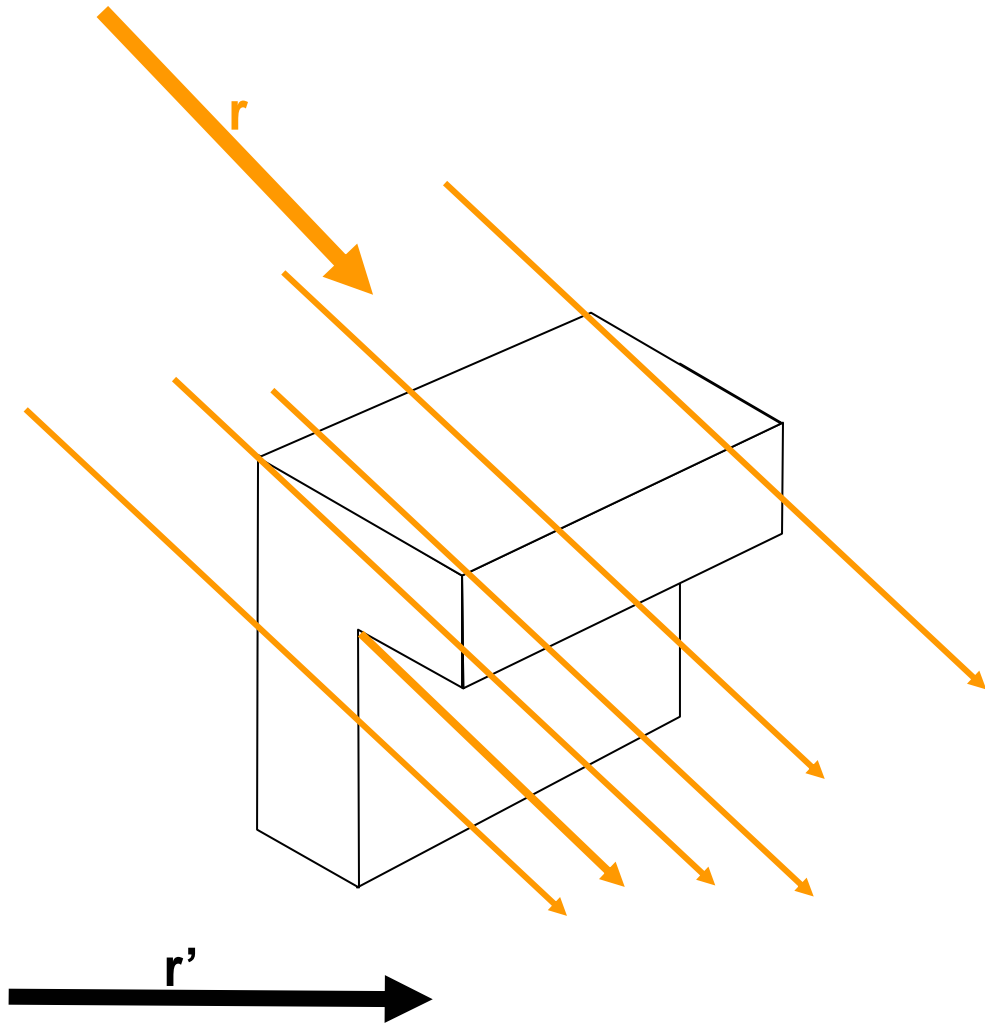

AXONOMETRÍA
SOMBRA

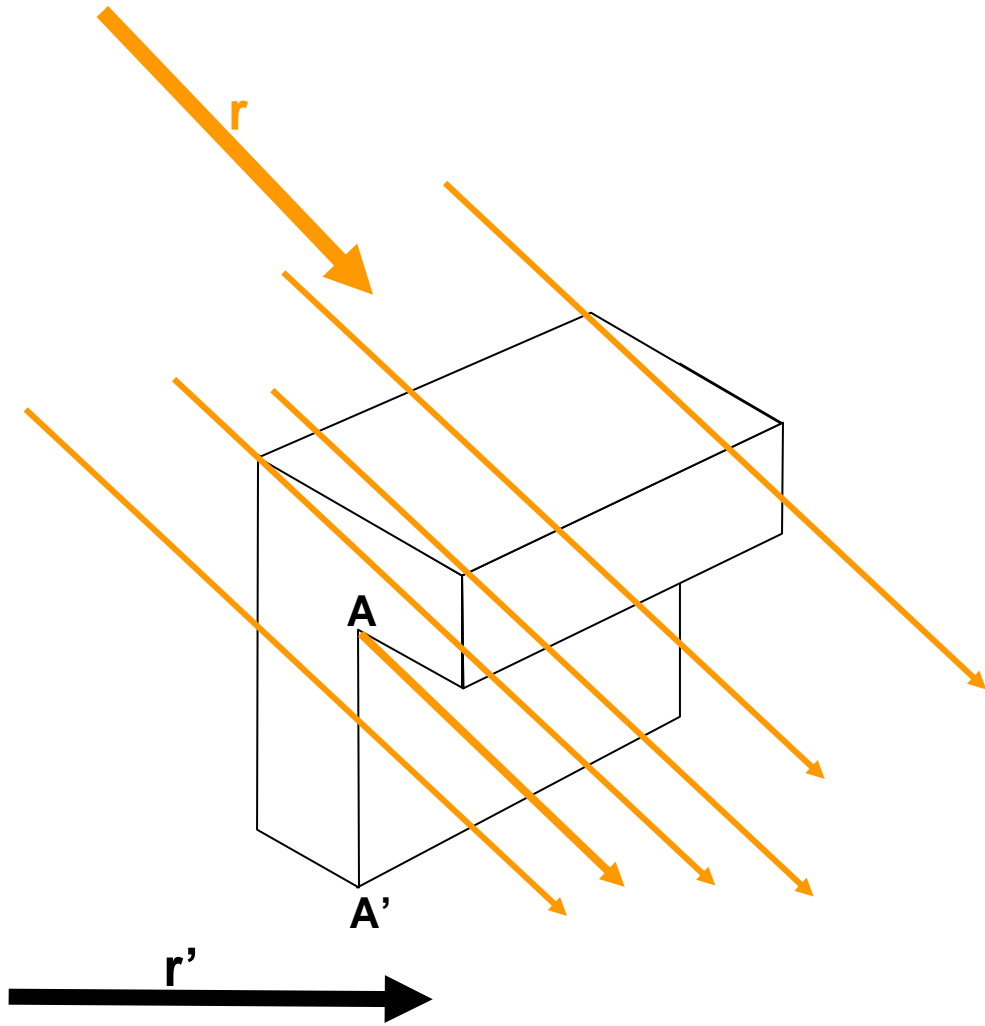

AXONOMETRÍA
SOMBRAS

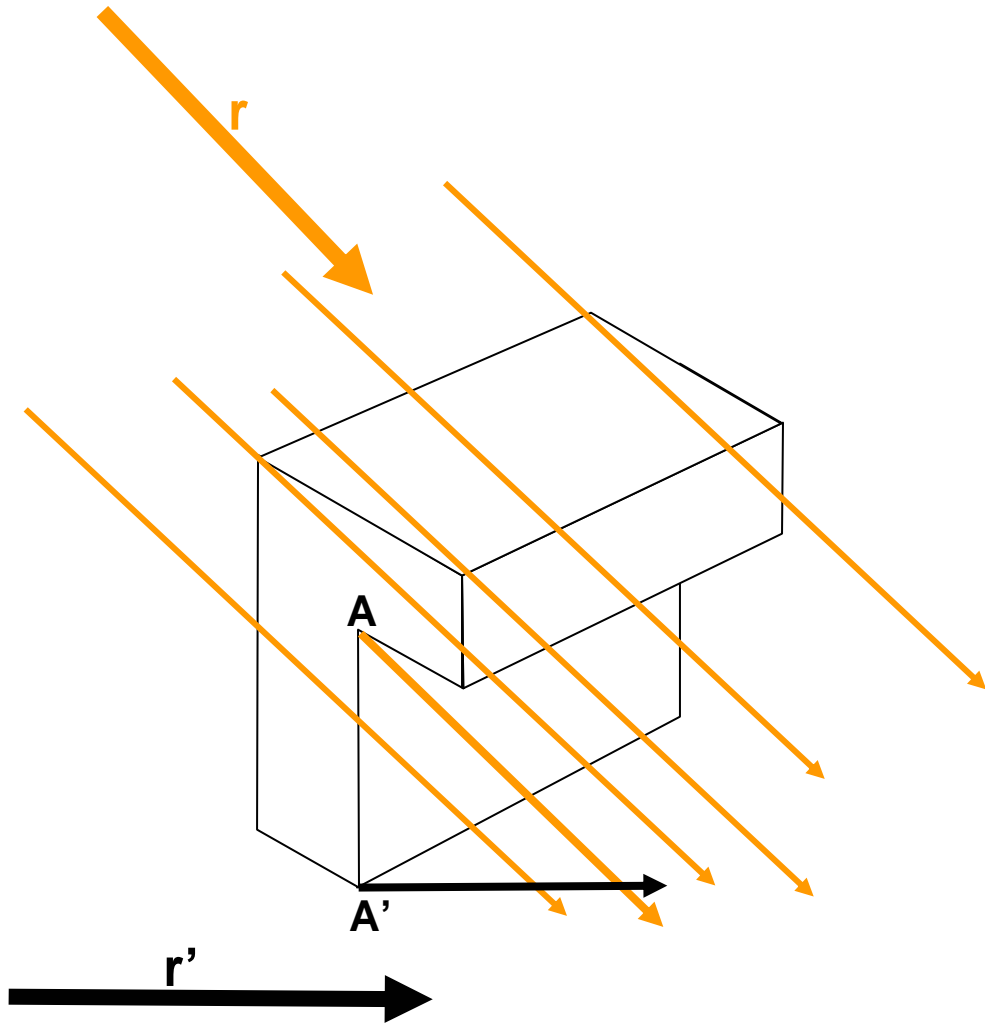

AXONOMETRÍA
SOMBRAS

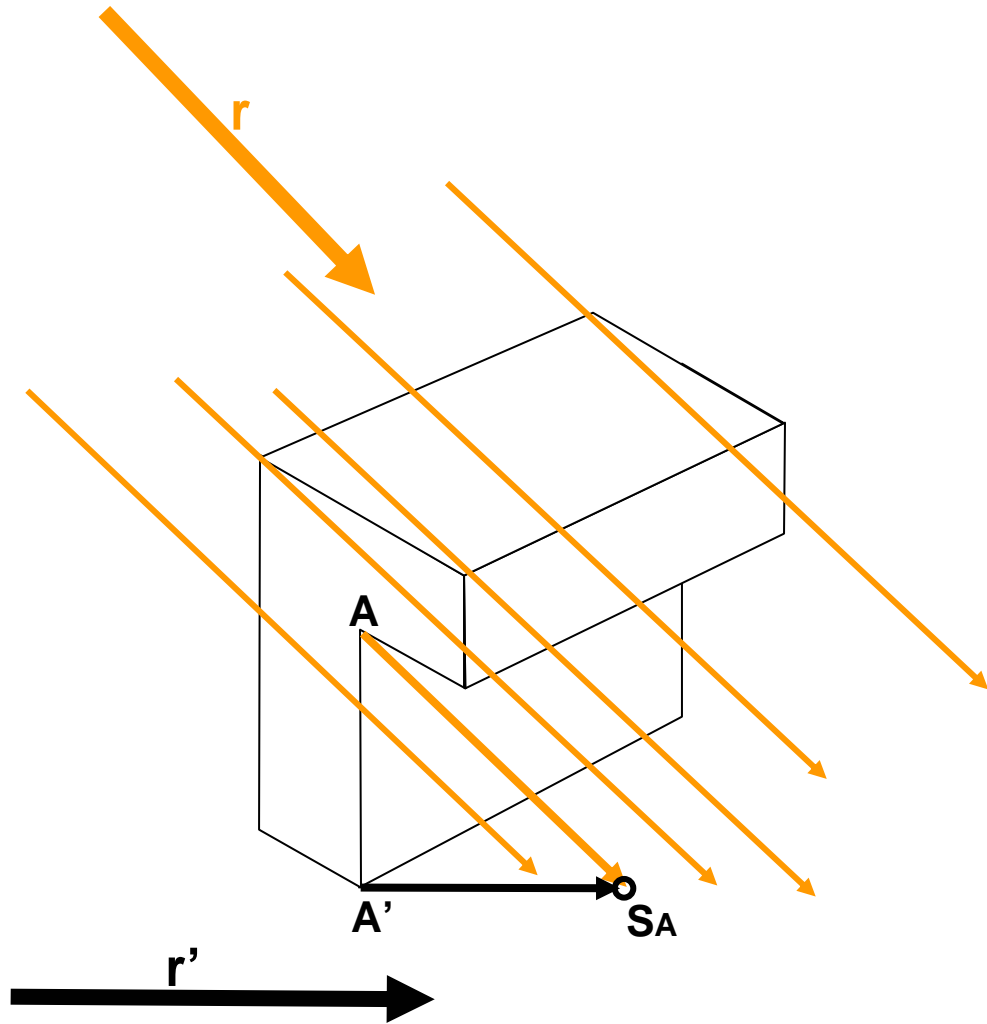

AXONOMETRÍA
SOMBRAS

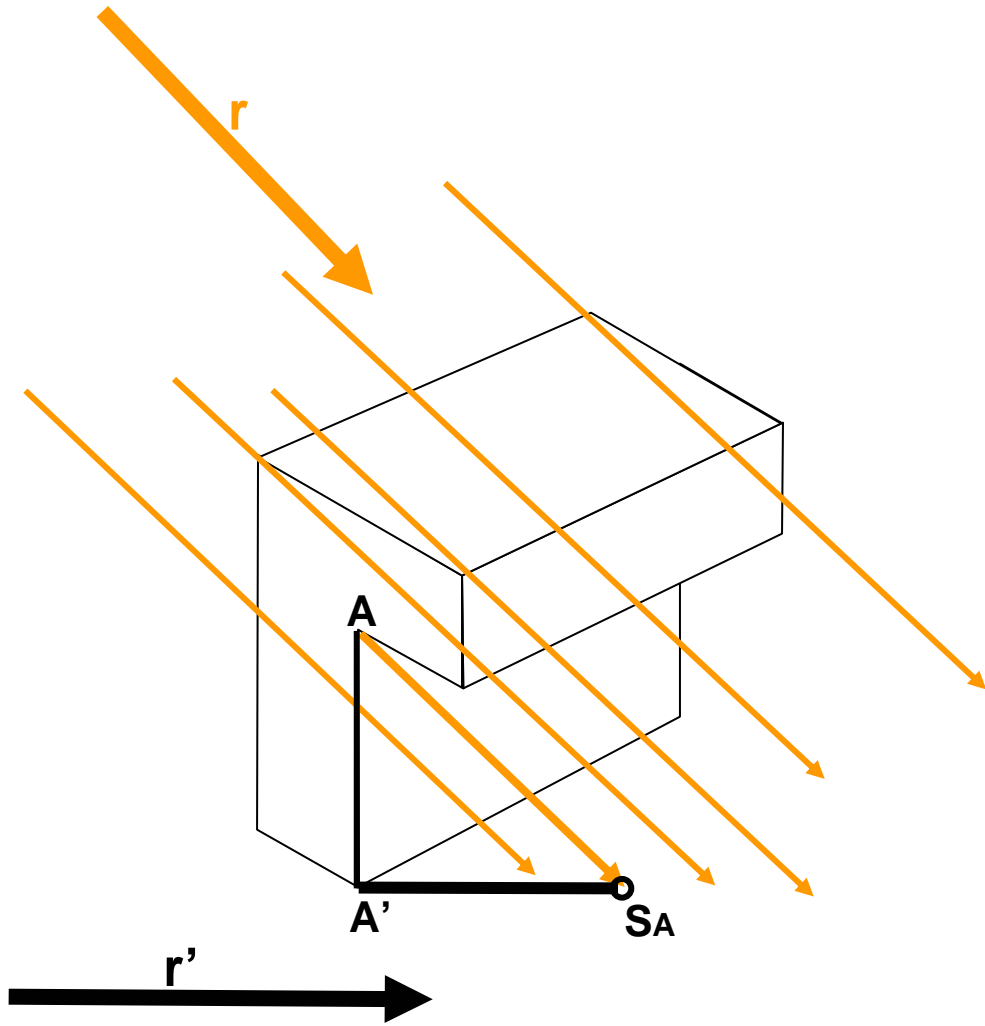

AXONOMETRÍA
SOMBRAS

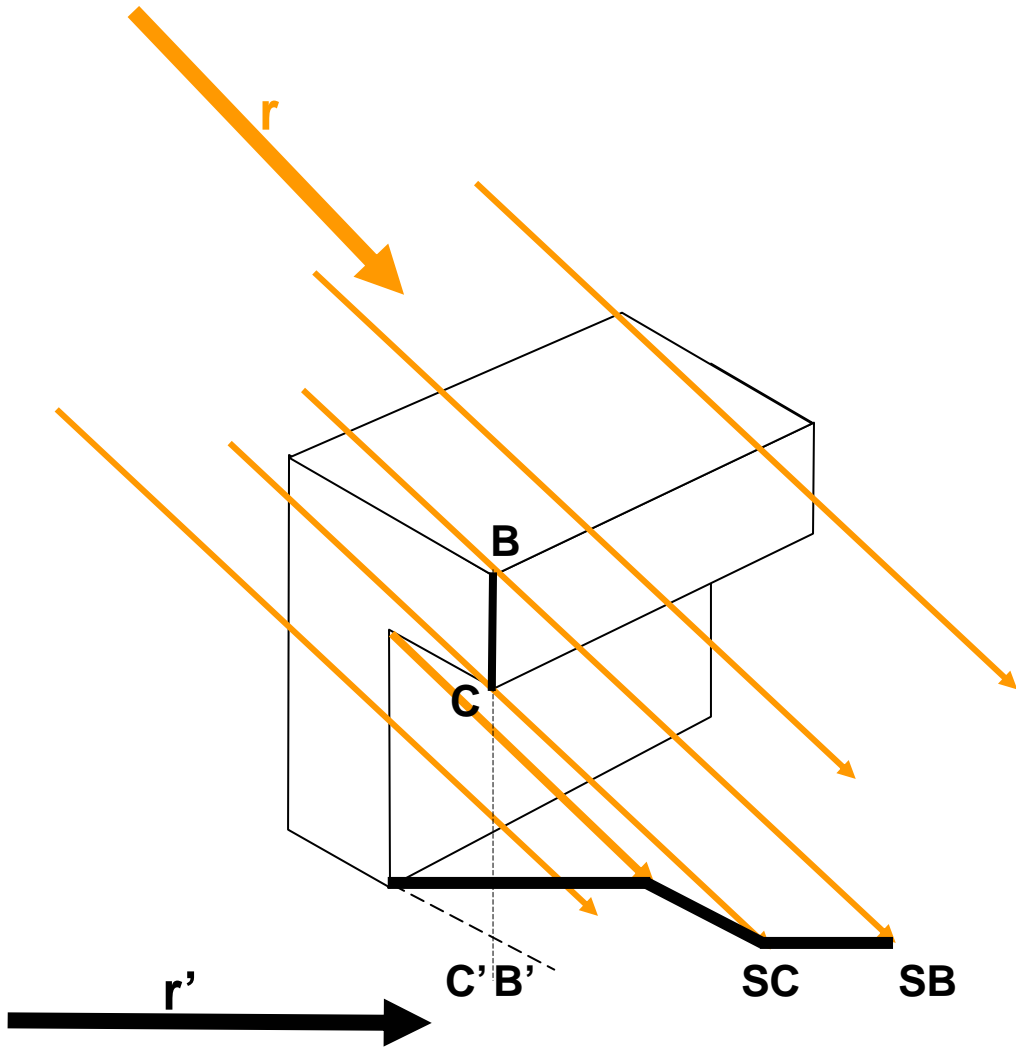

AXONOMETRÍA
SOMBRA

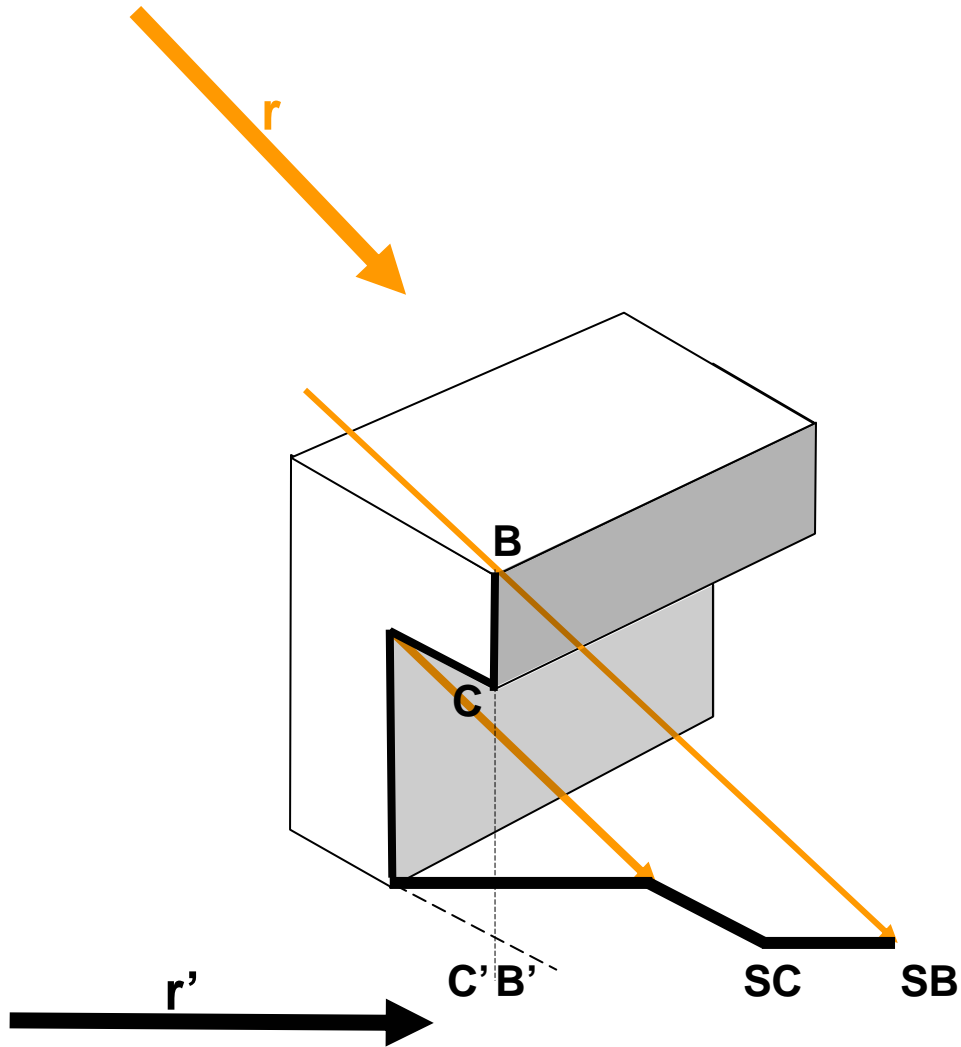

AXONOMETRÍA
SOMBRAS

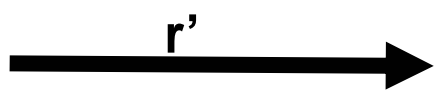
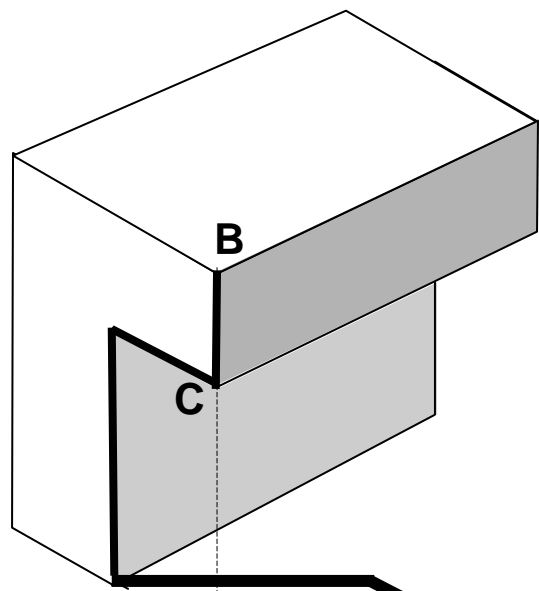
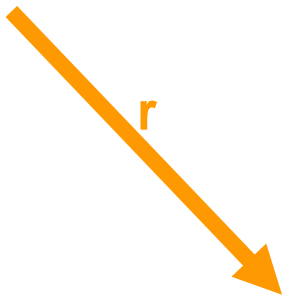

C'B'

SC

SB

AXONOMETRÍA
SOMBRAS

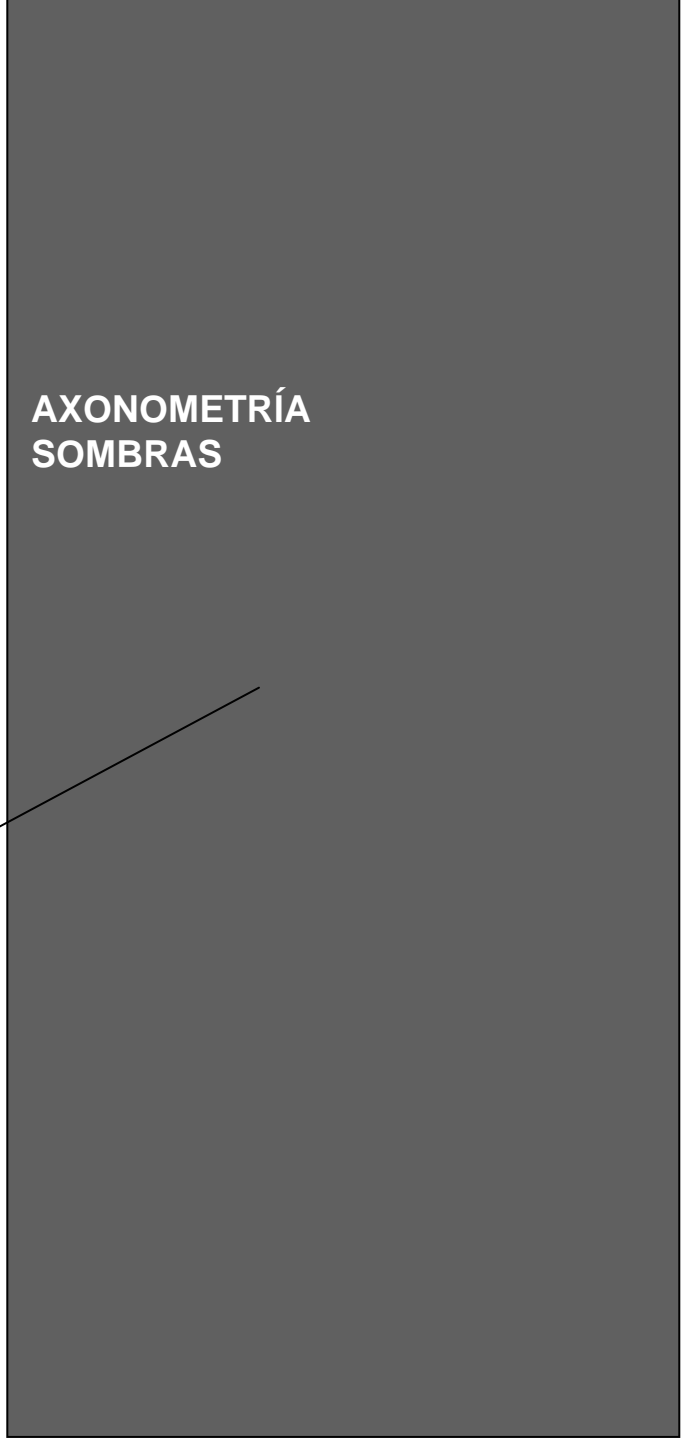

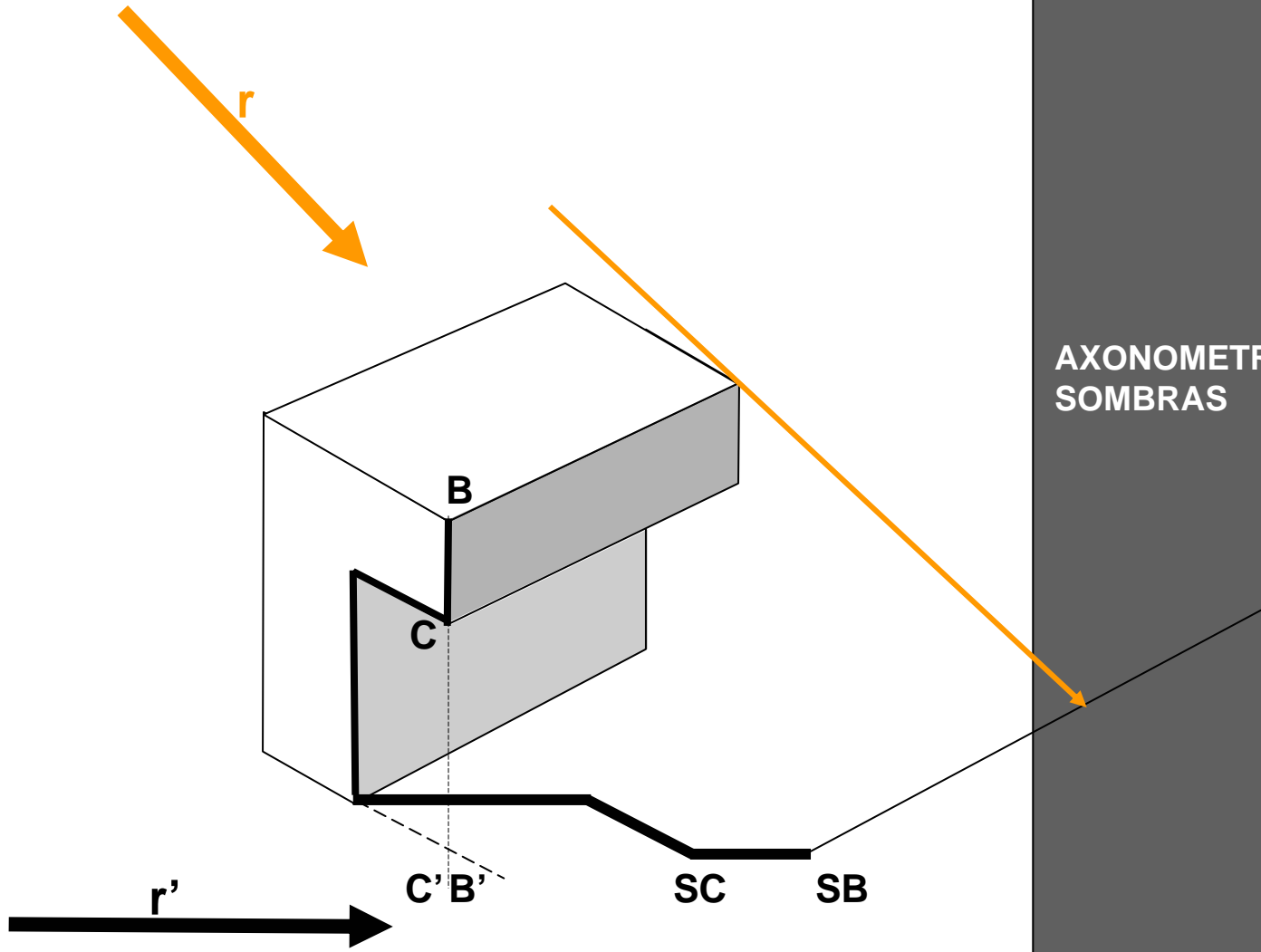

**AXONOMETRÍA
SOMBRAS**

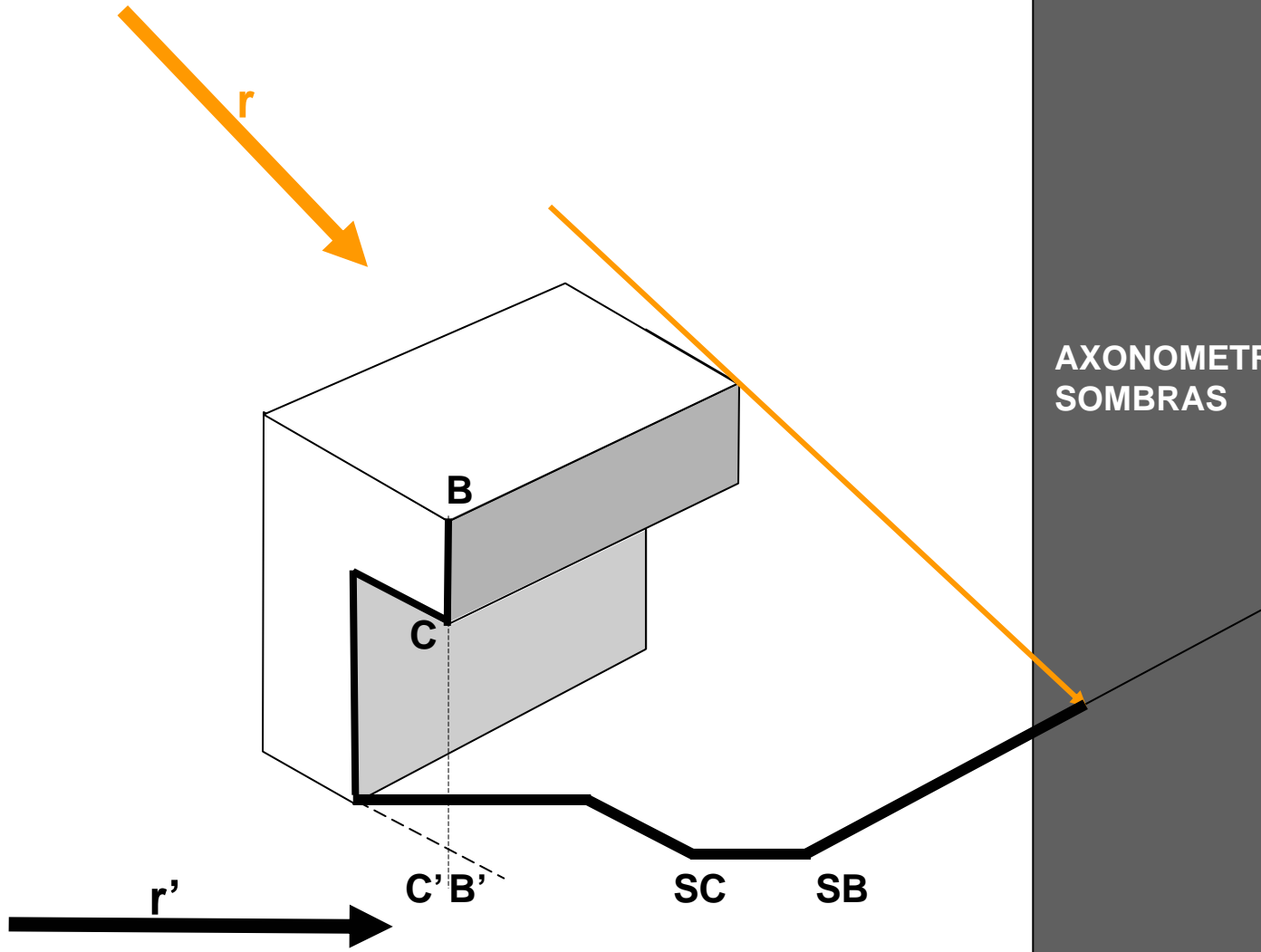

**AXONOMETRÍA
SOMBRAS**

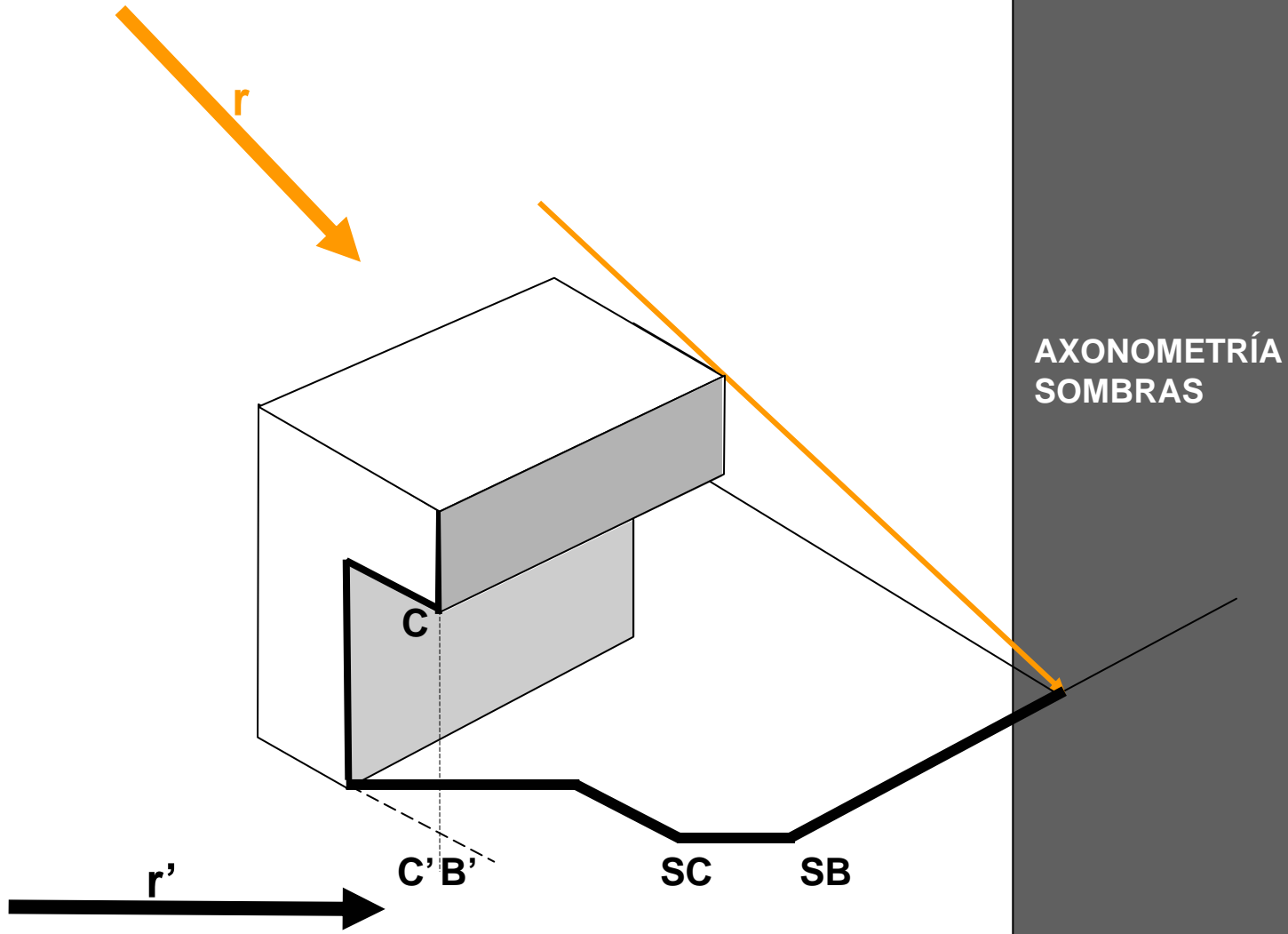

AXONOMETRÍA
SOMBRAS

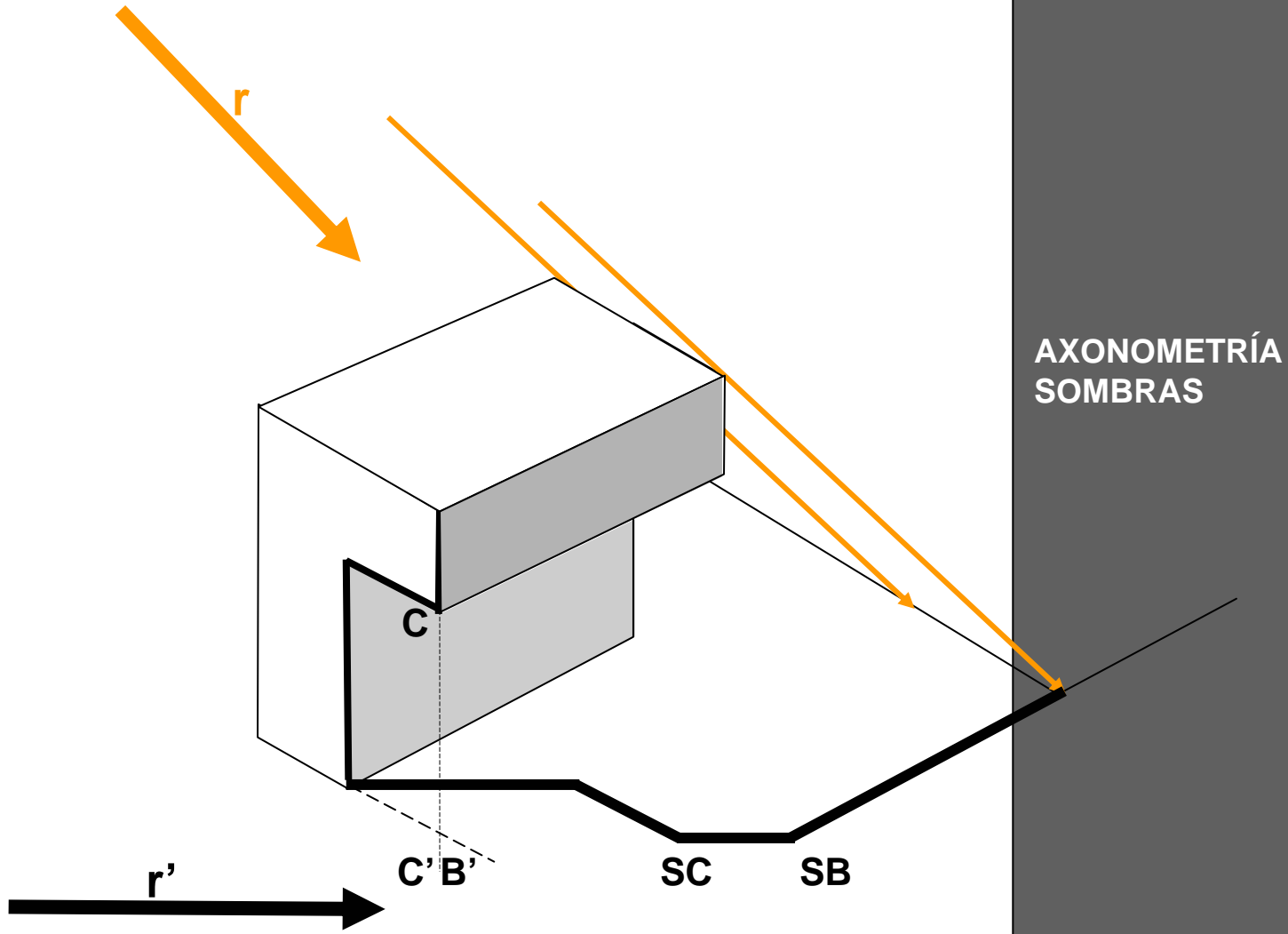

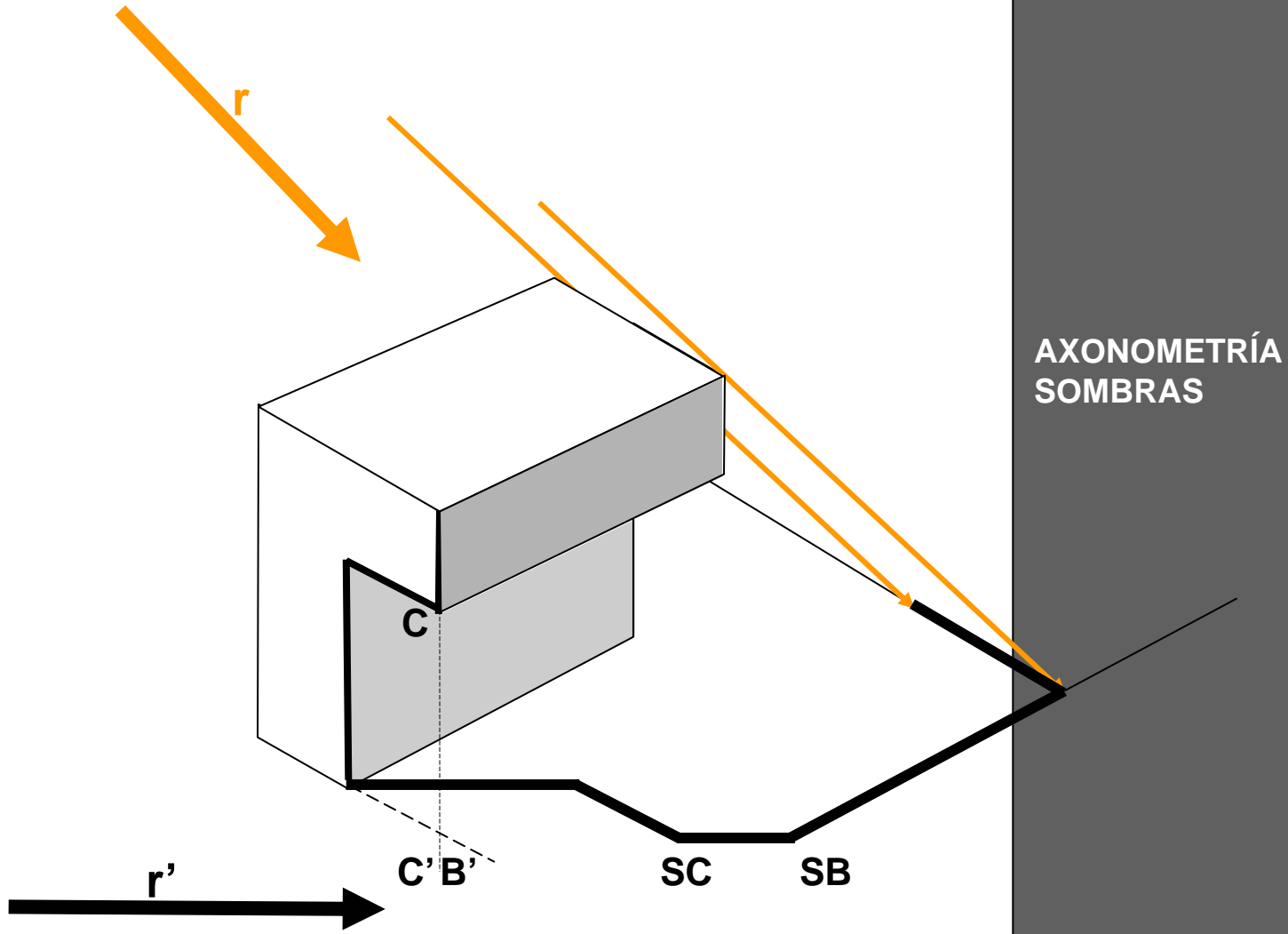

AXONOMETRÍA
SOMBRAS

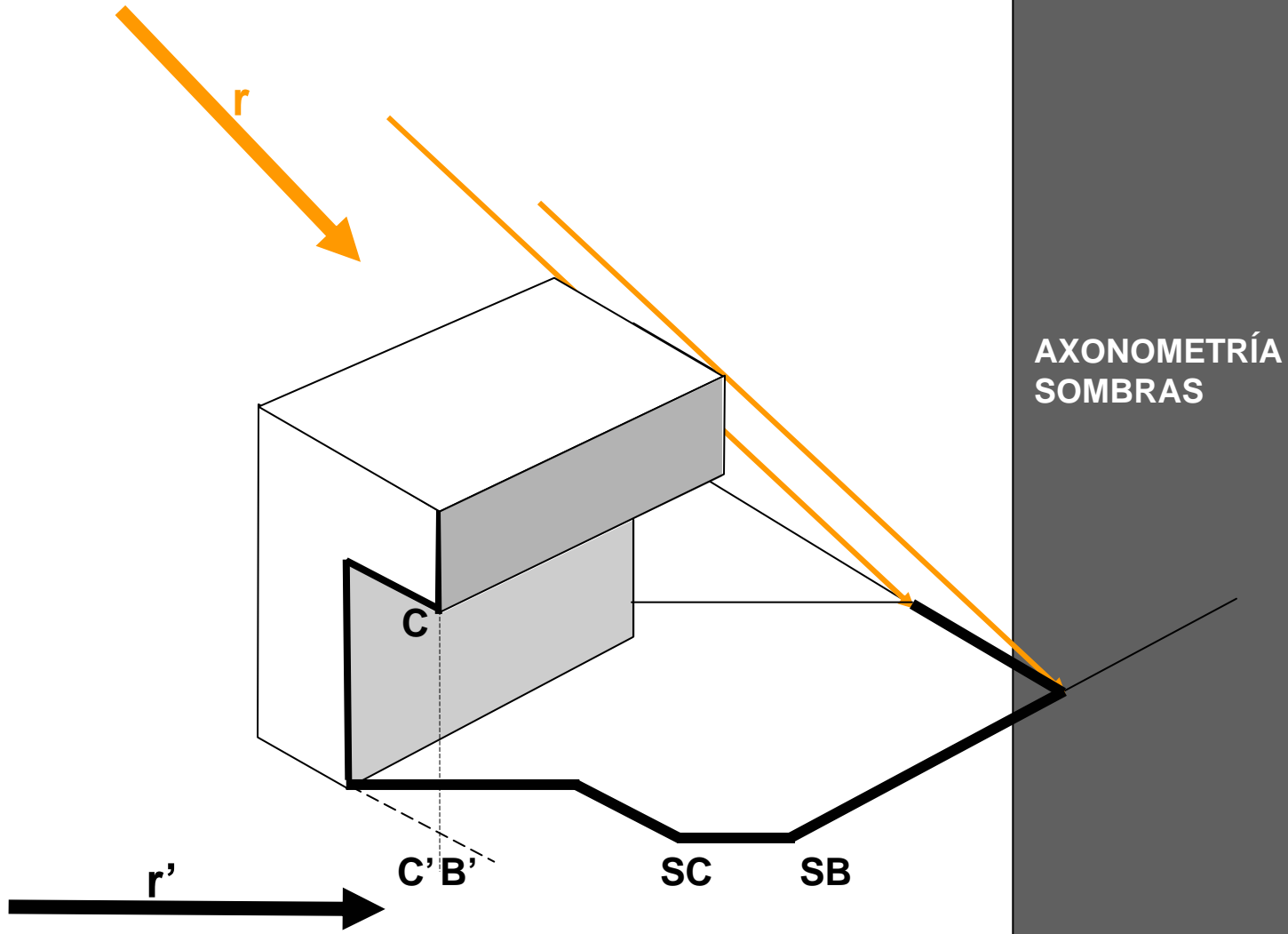

AXONOMETRÍA
SOMBRAS

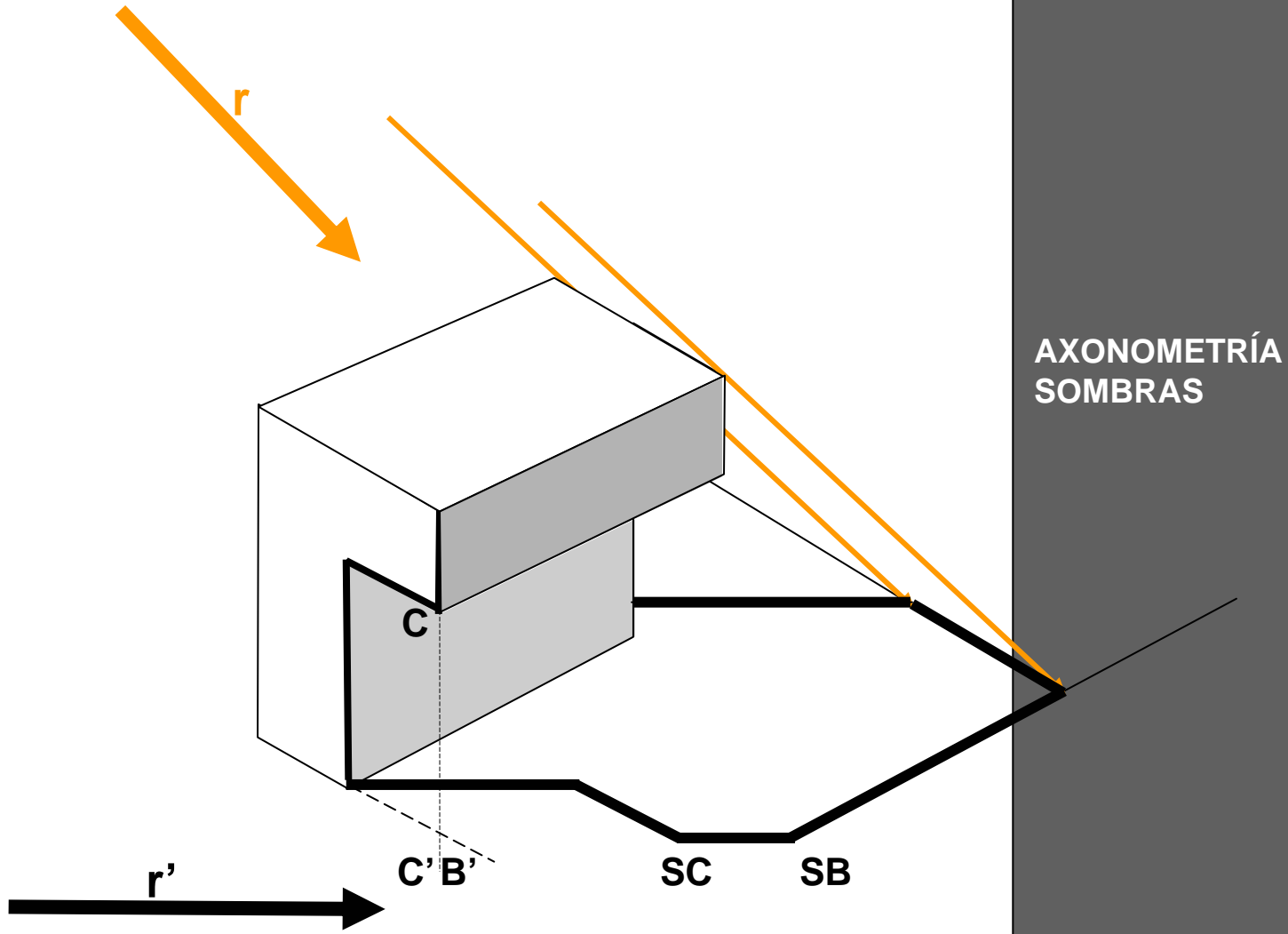

**AXONOMETRÍA
SOMBRAS**

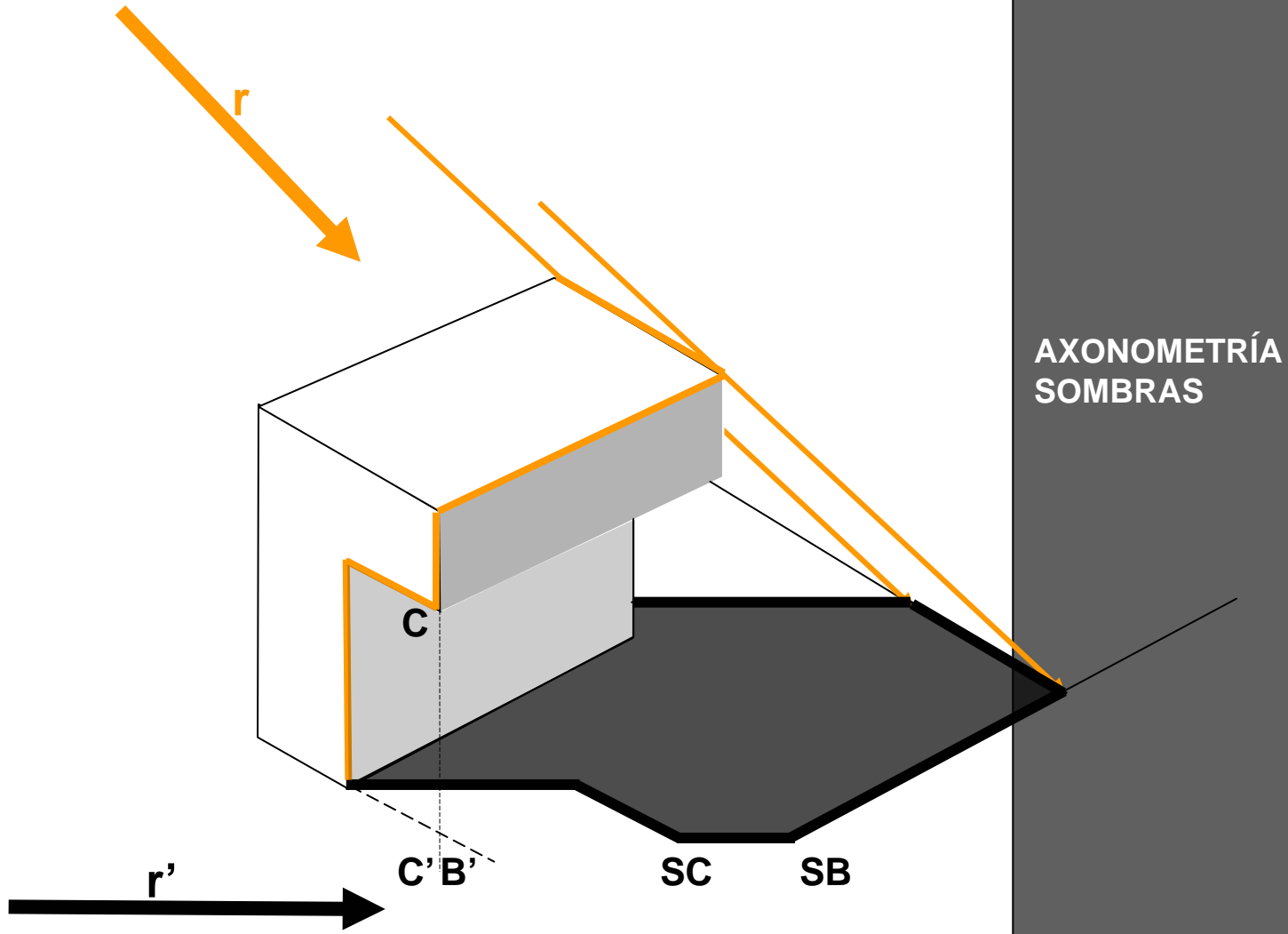

AXONOMETRÍA
SOMBRAS

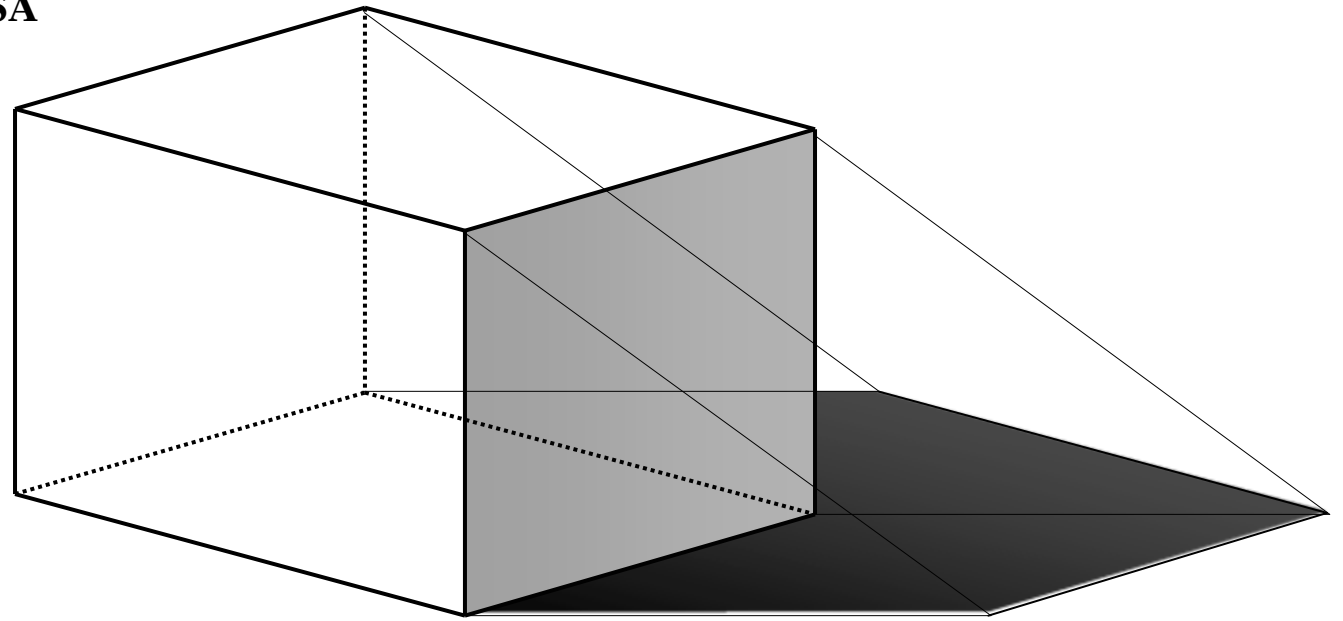
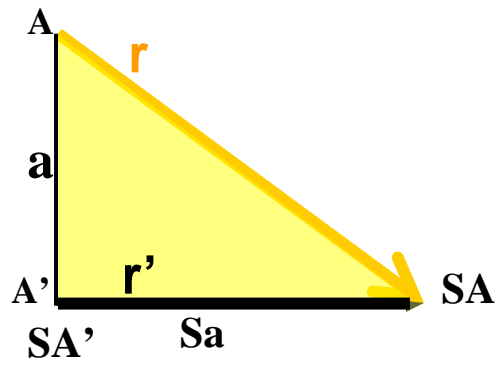

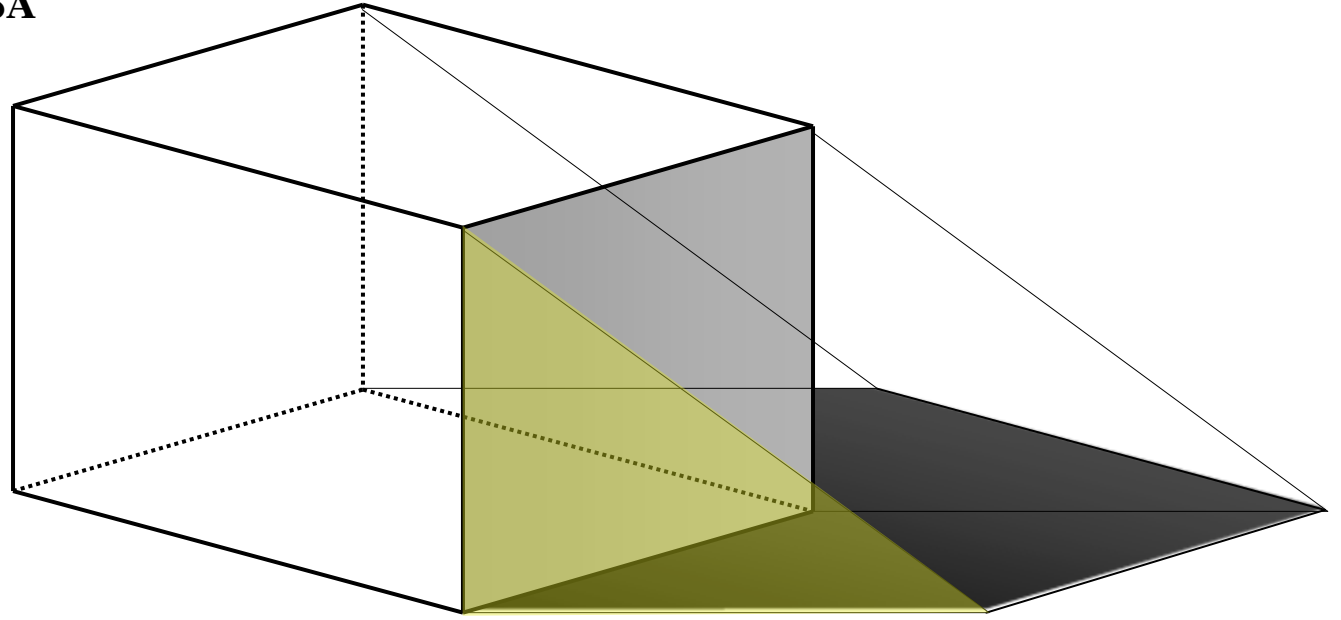
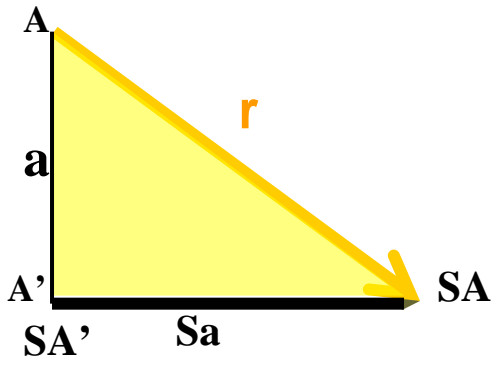

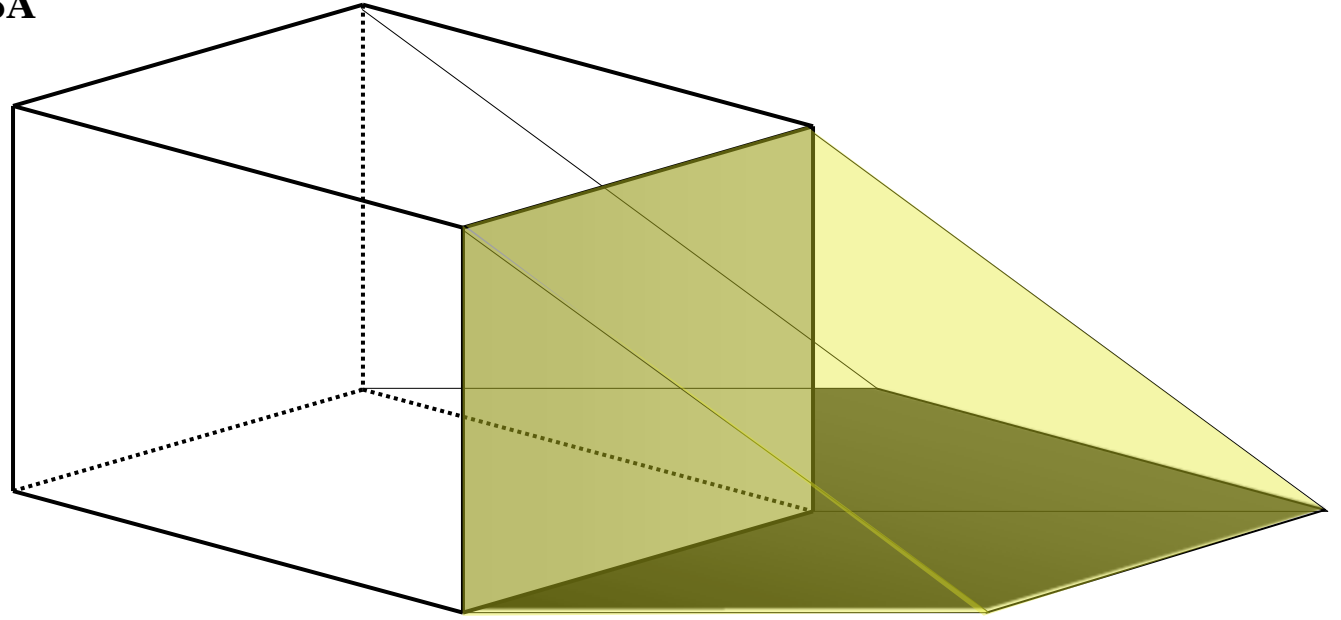
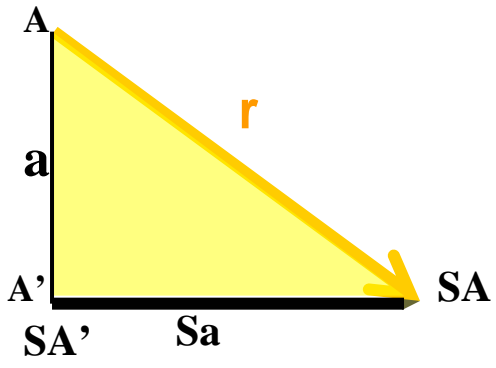

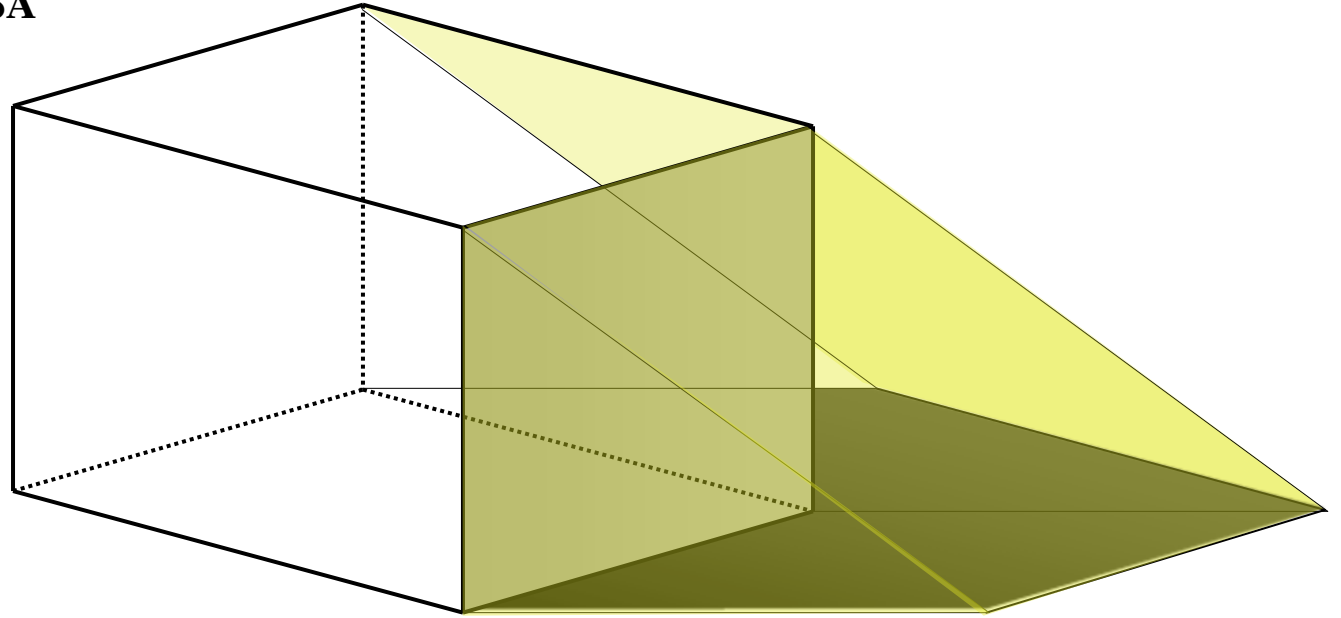
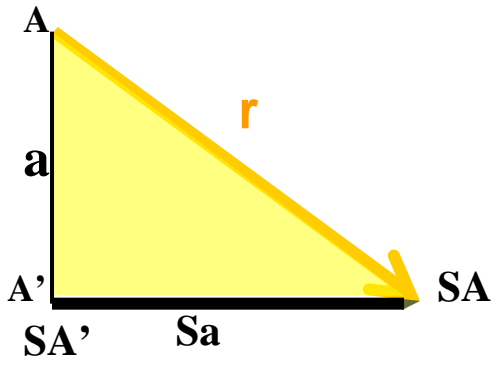

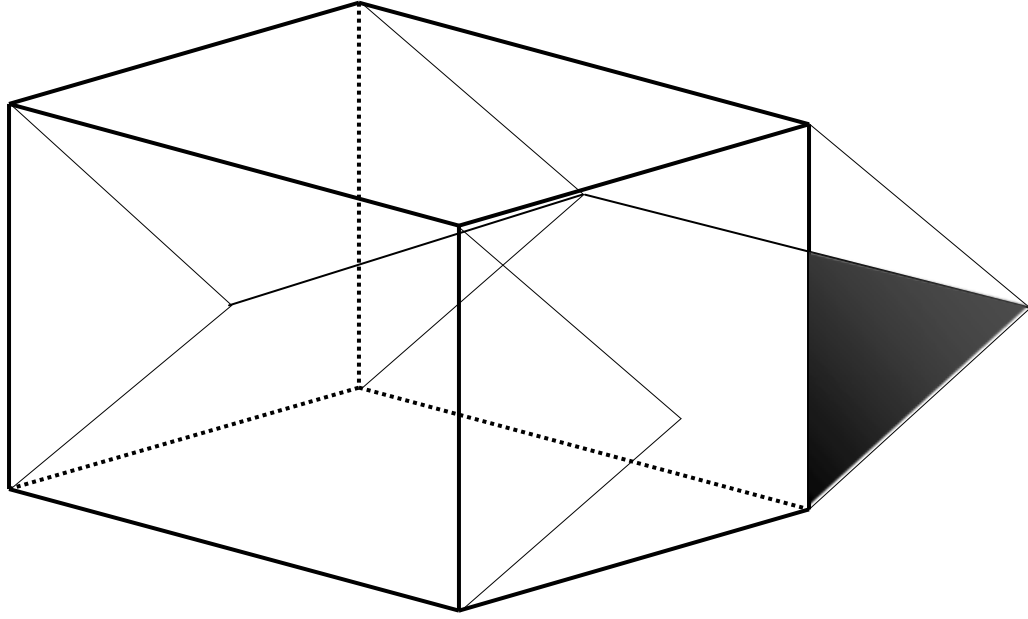
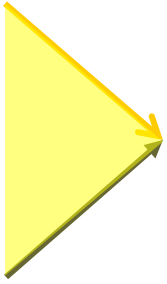

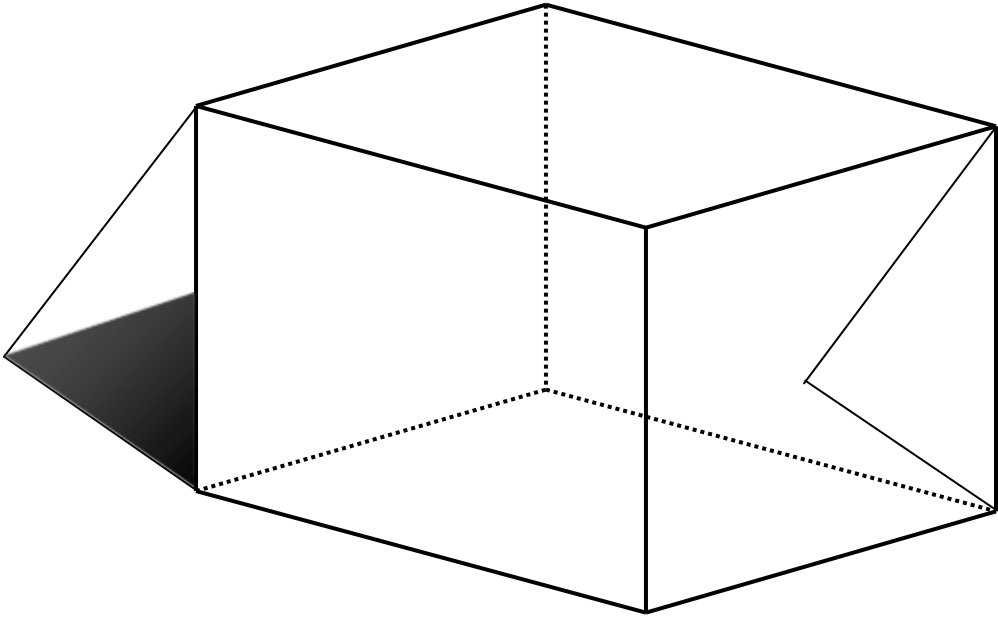

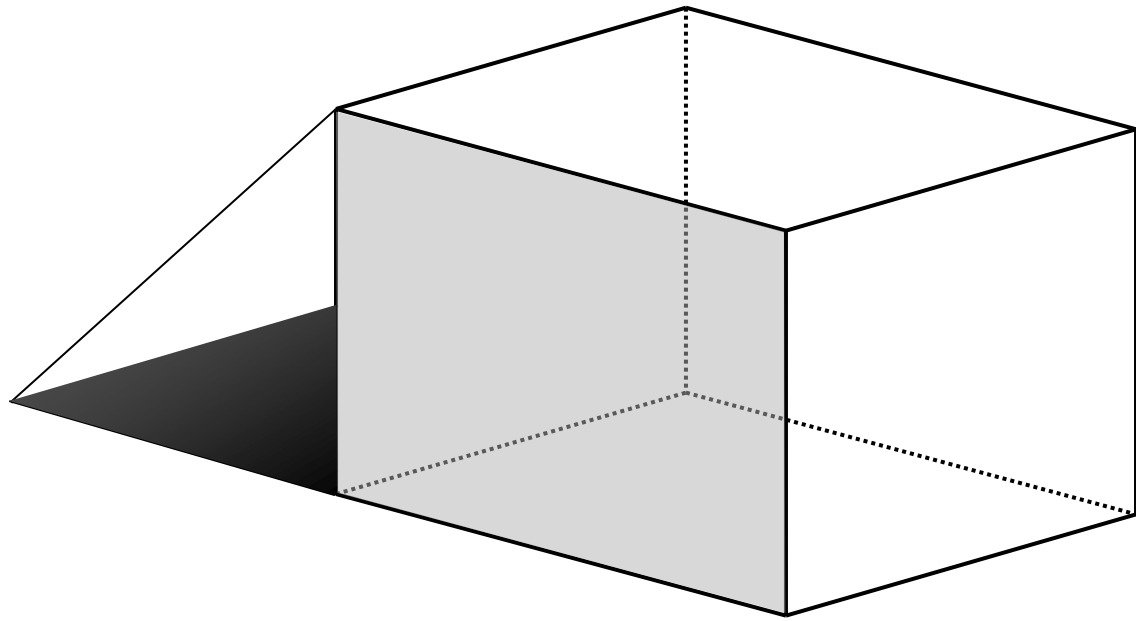
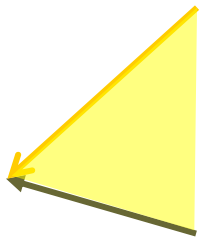

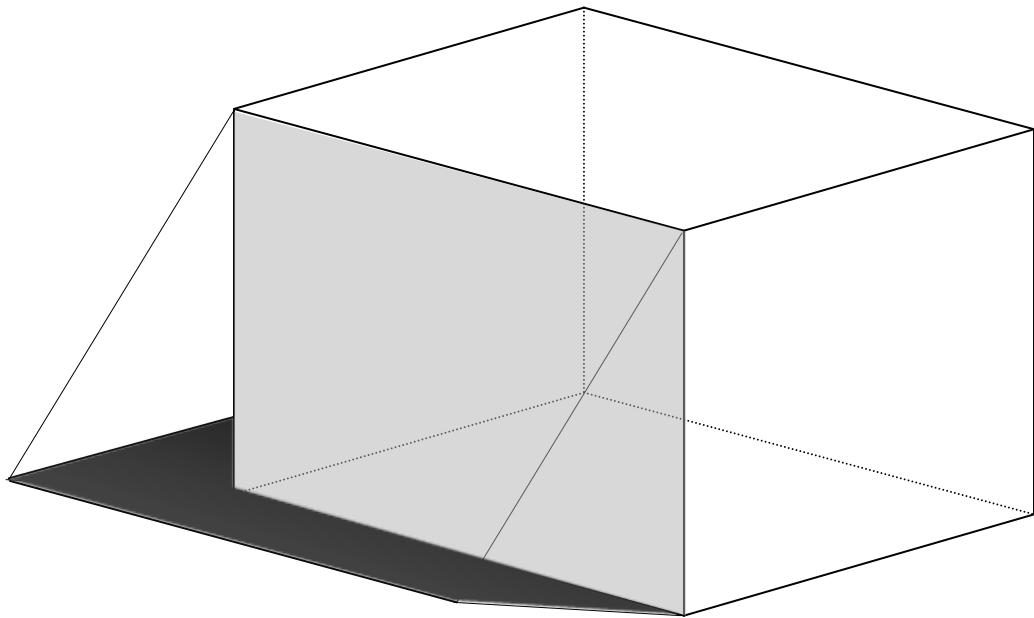
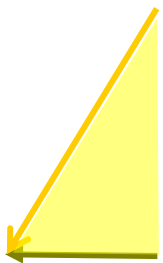

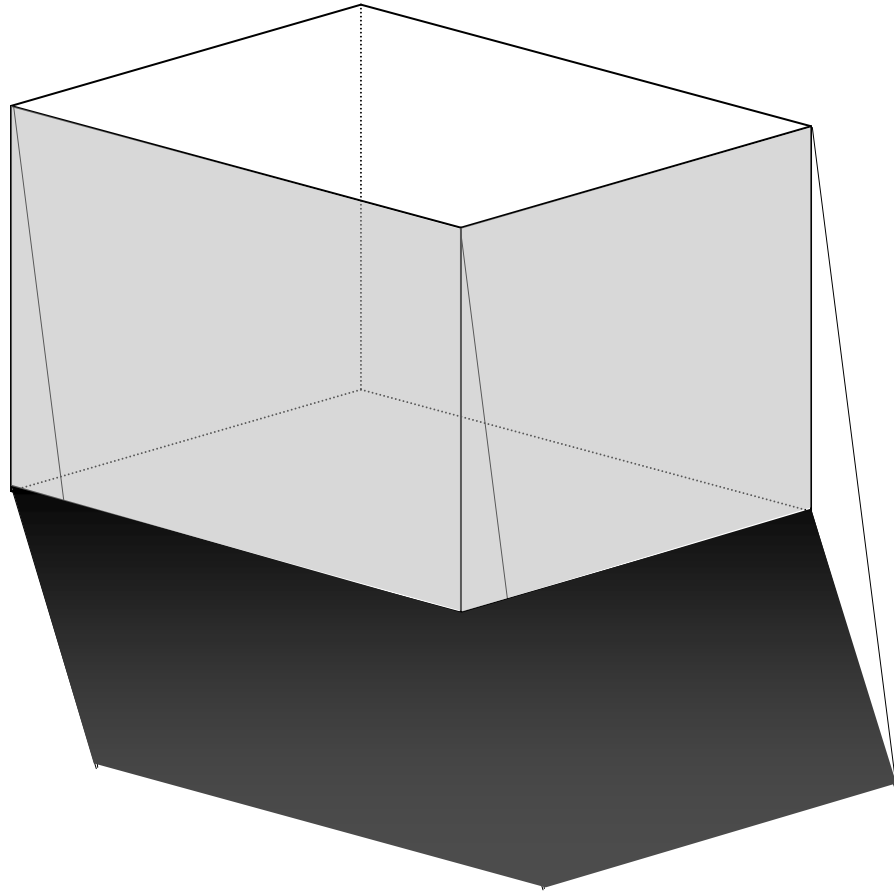

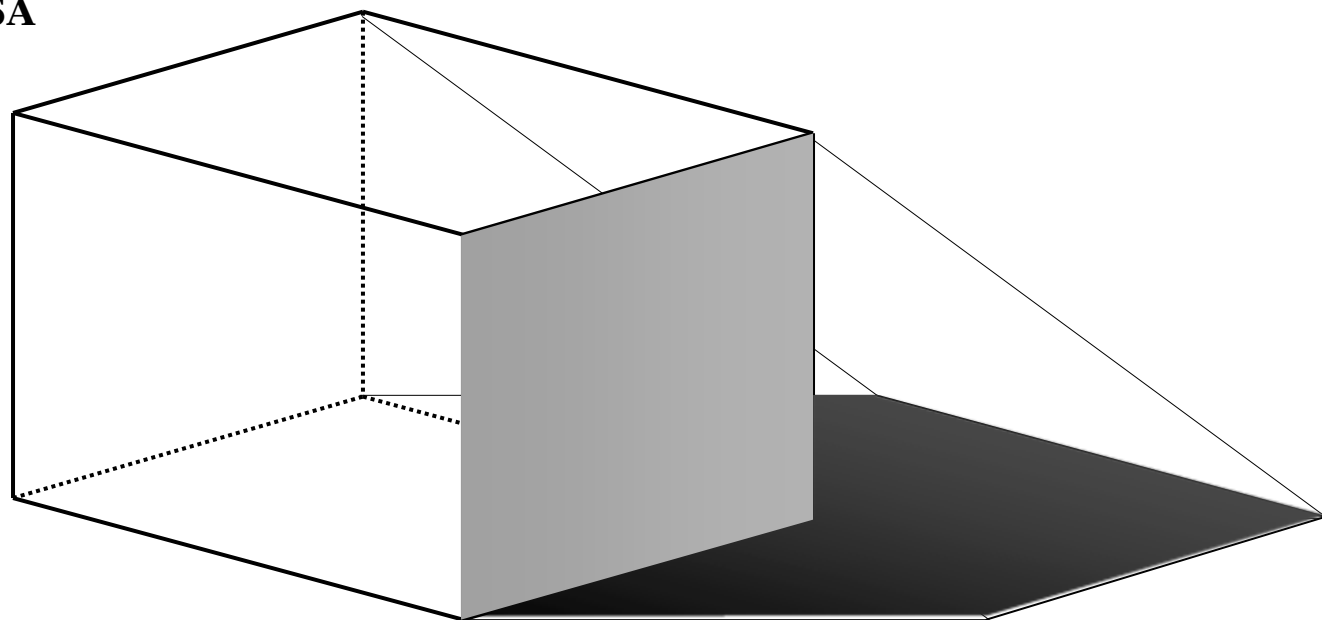
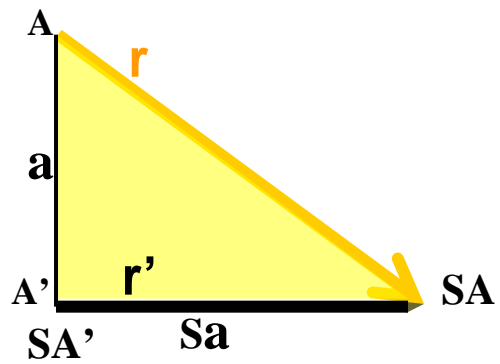

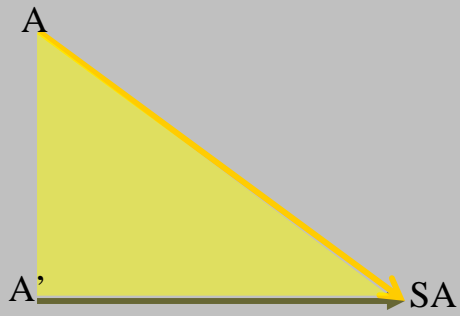

SEPARATRIZ DE LUZ Y SOMBRA

límite entre caras iluminadas y
caras en sombra propia

define el perfil de la sombra
arrojada

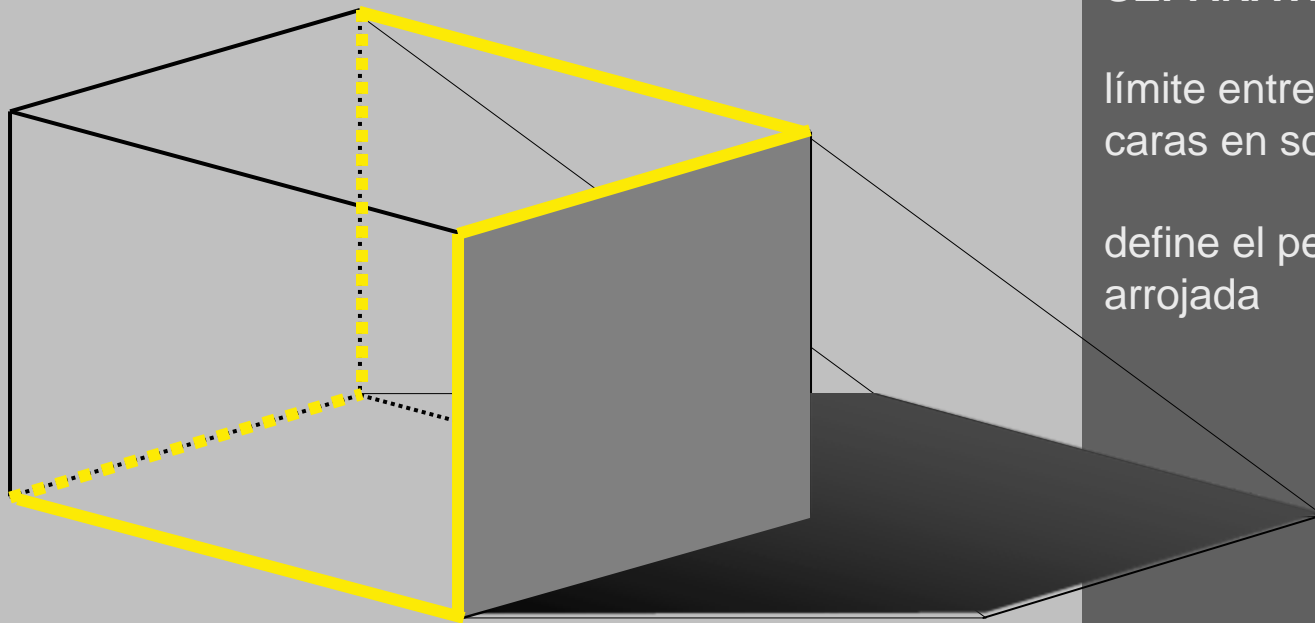

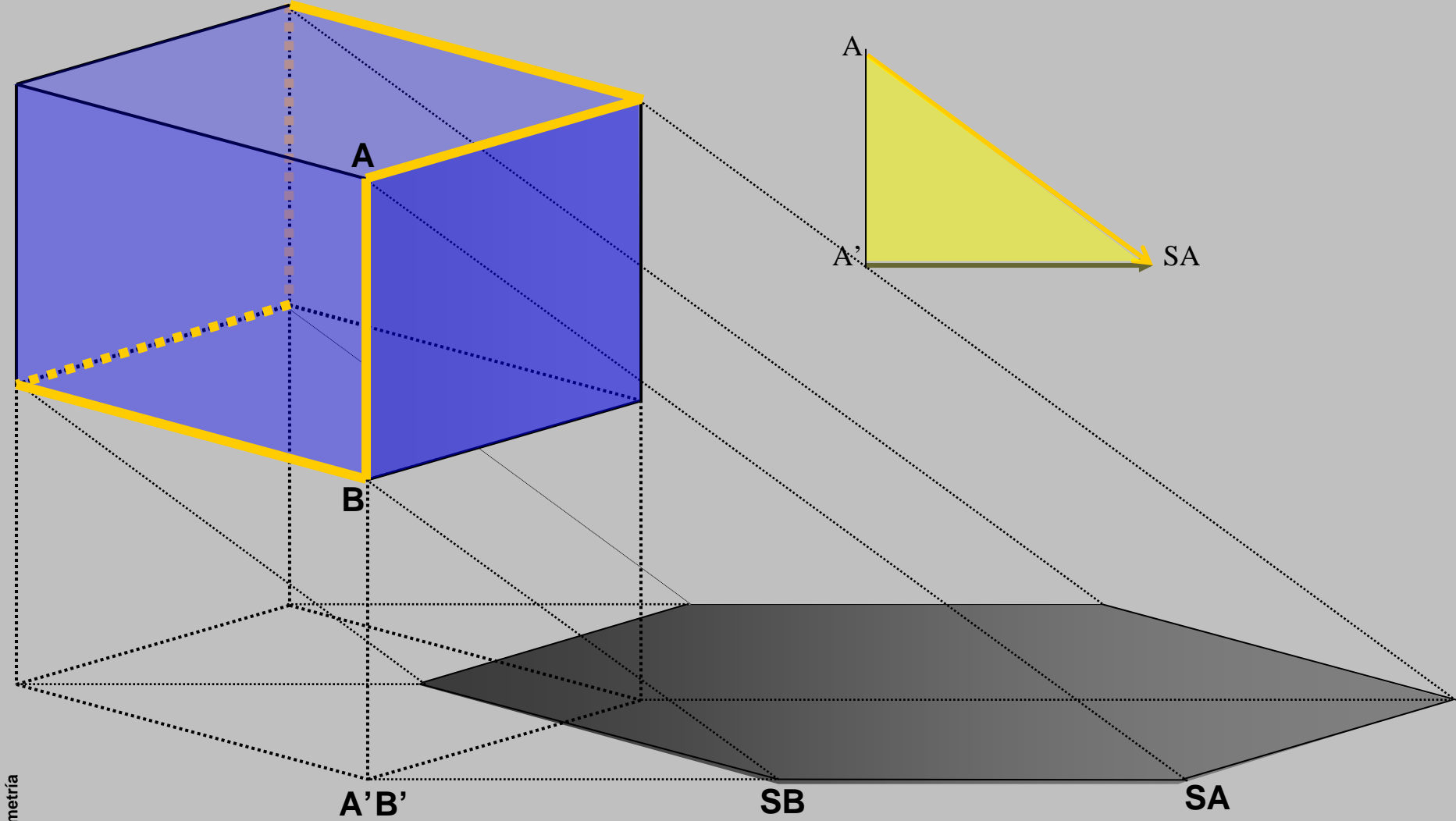

Axonometría

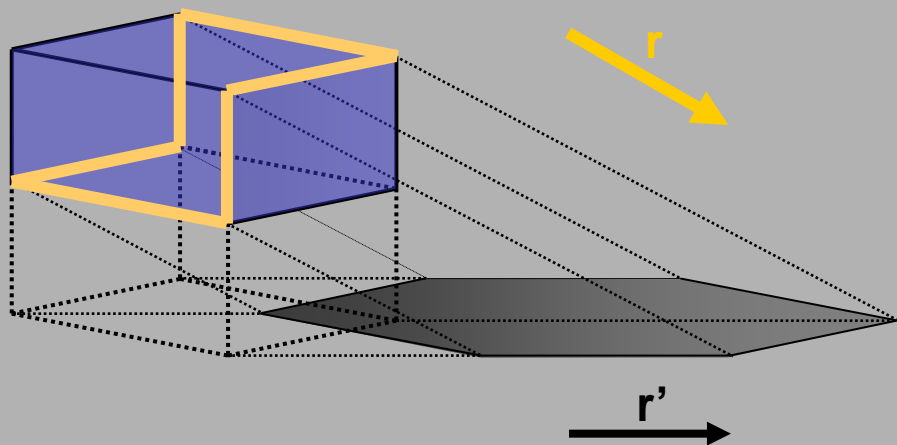

Diédrico Ortogonal

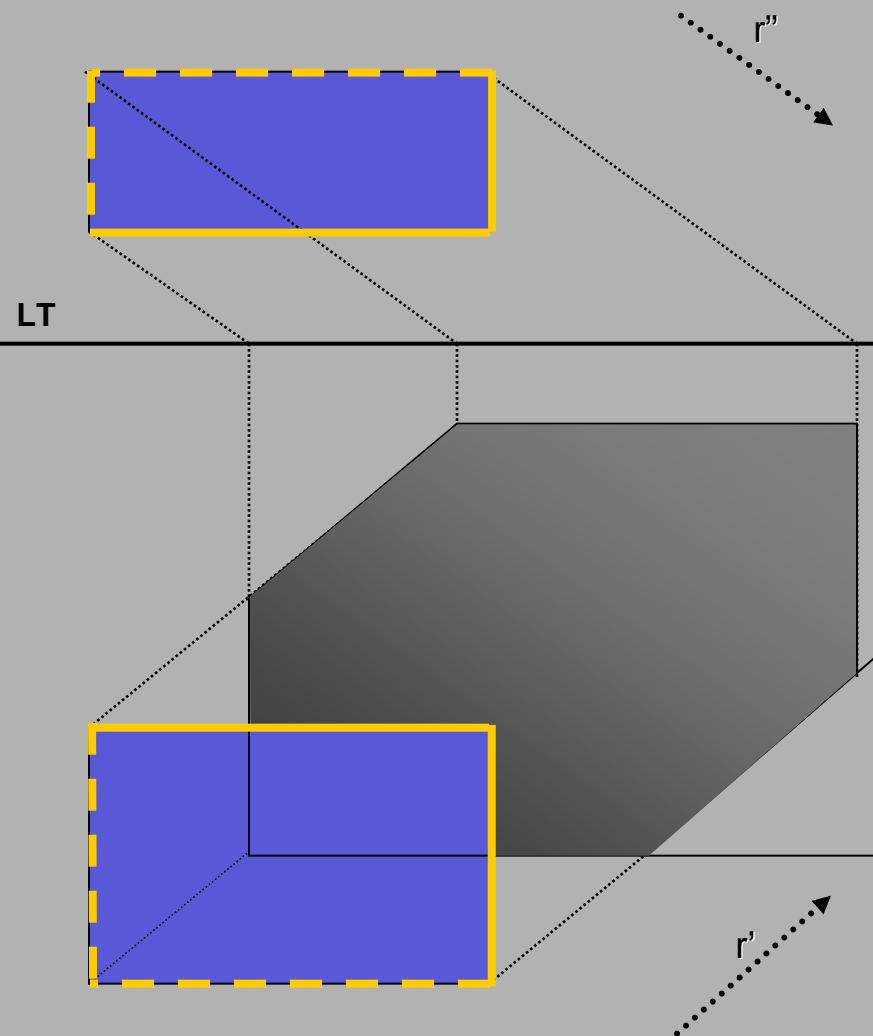

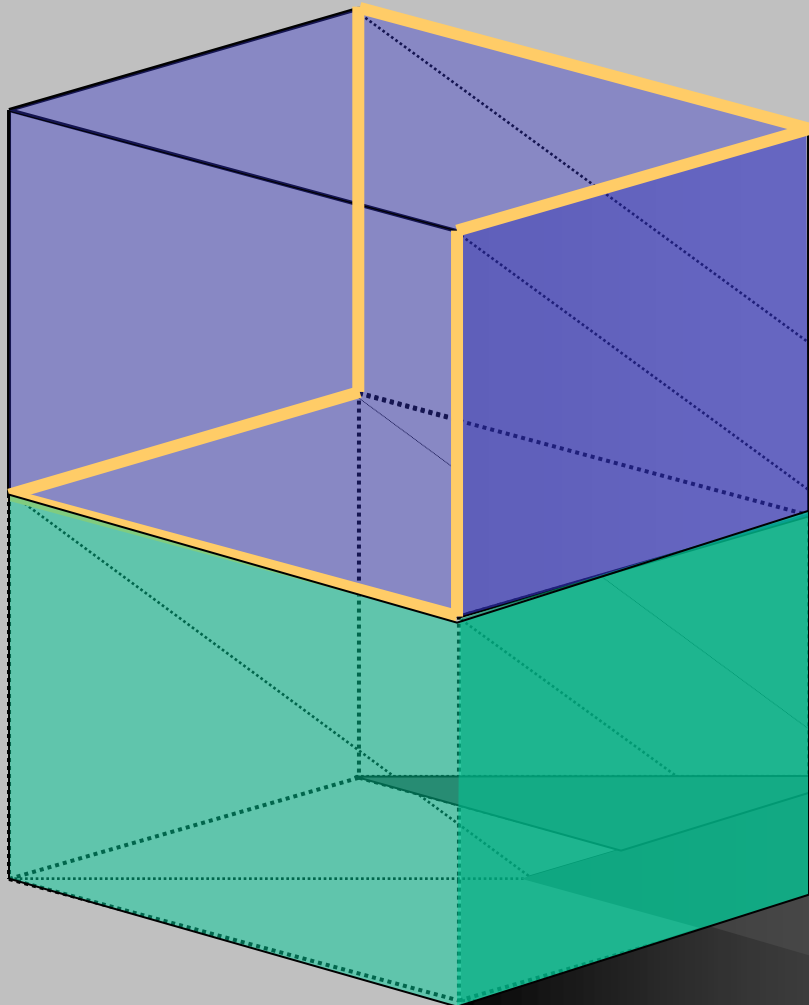

LT

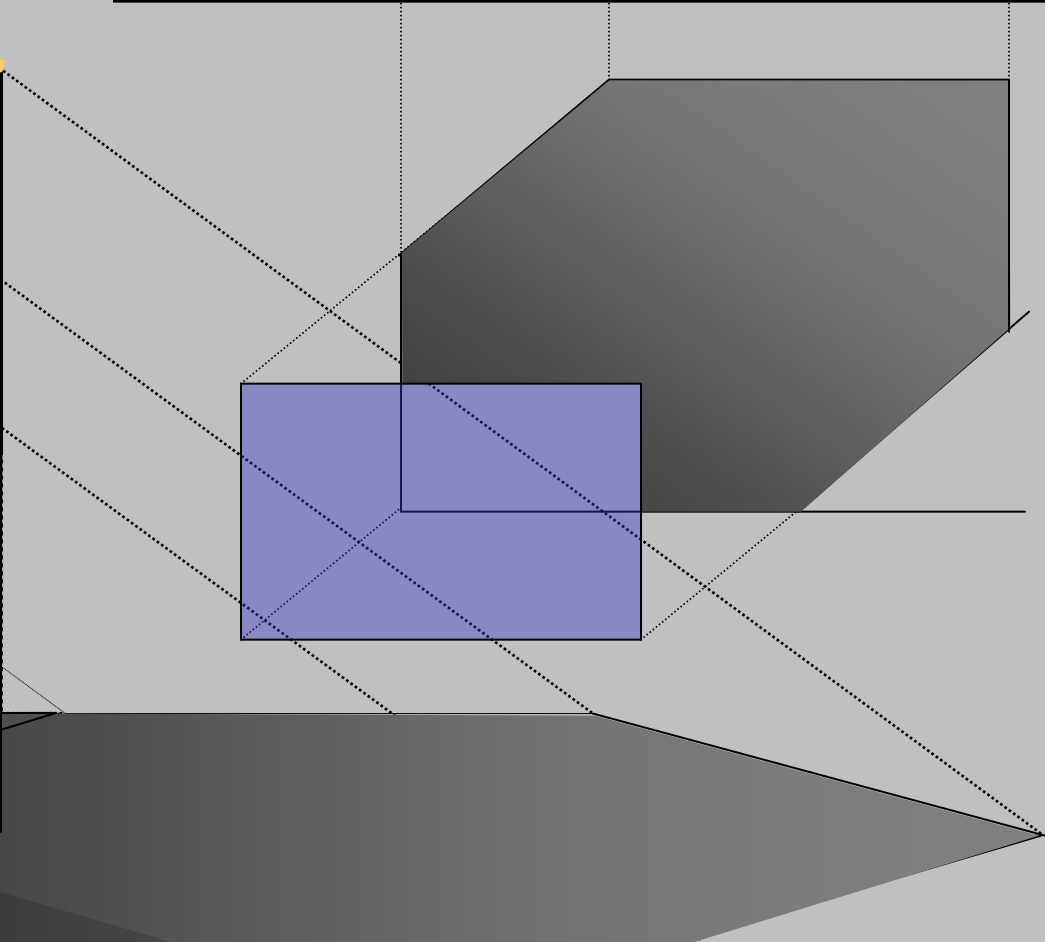
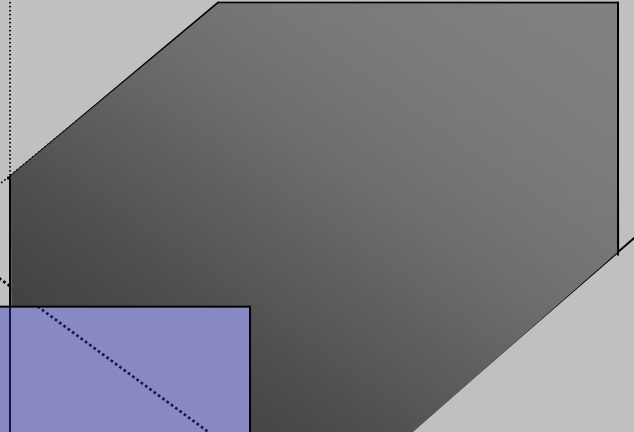
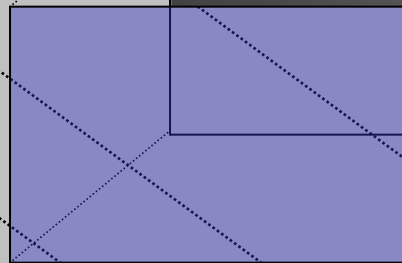
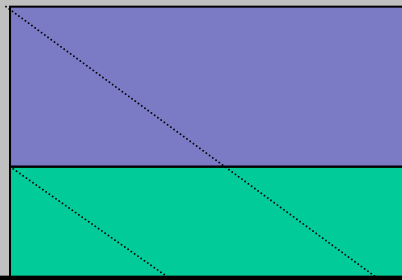

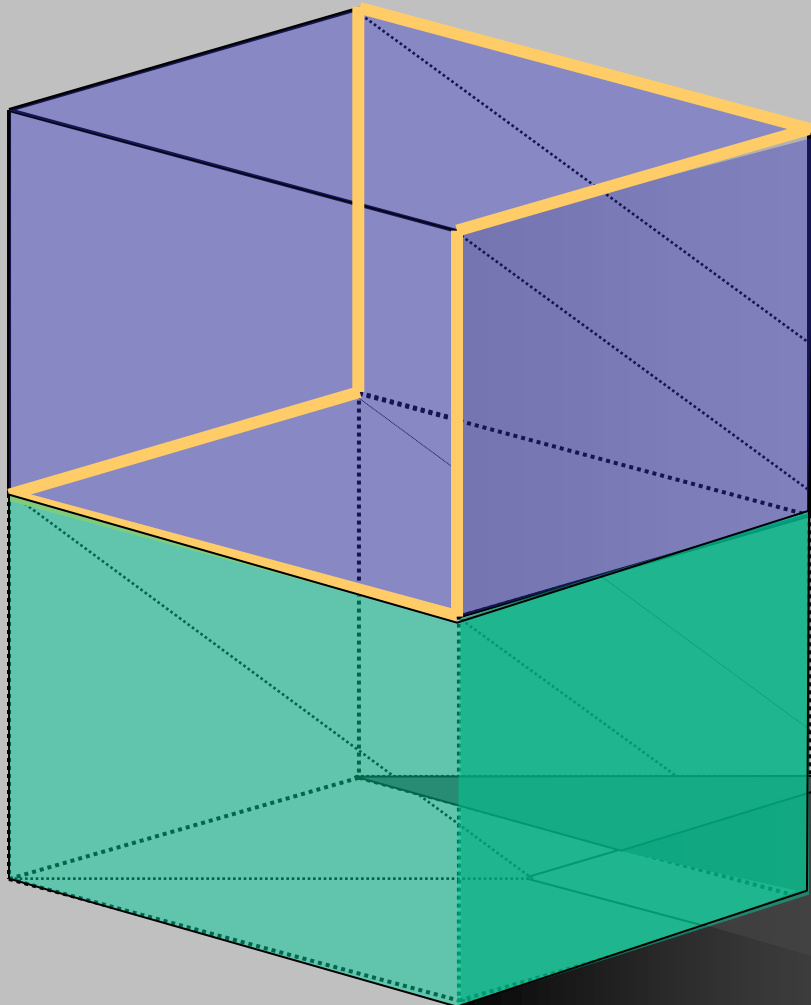

LT

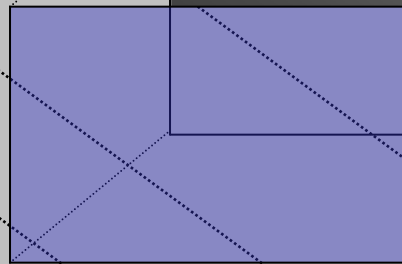
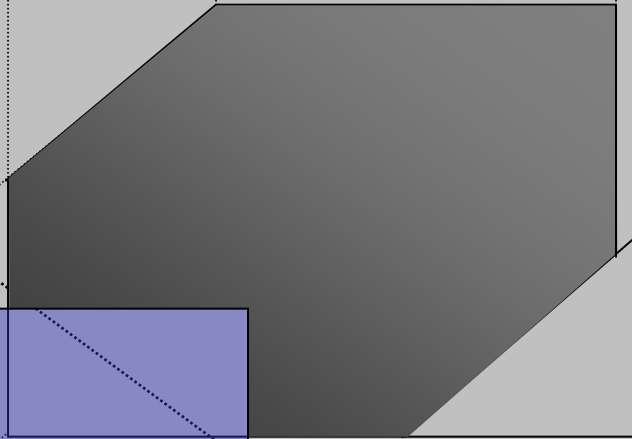
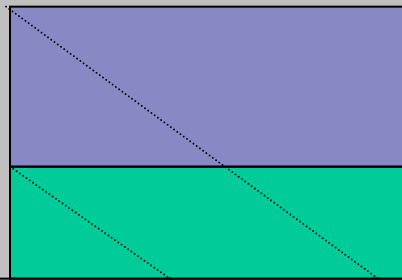

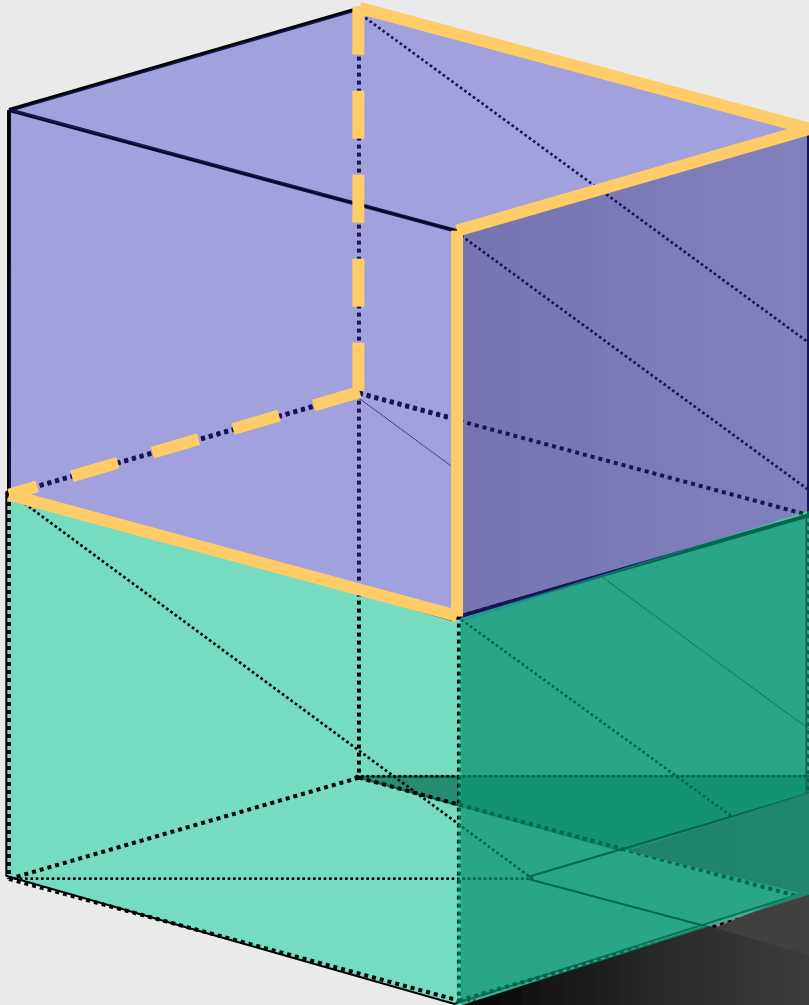

LT

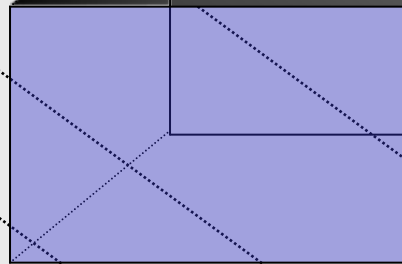
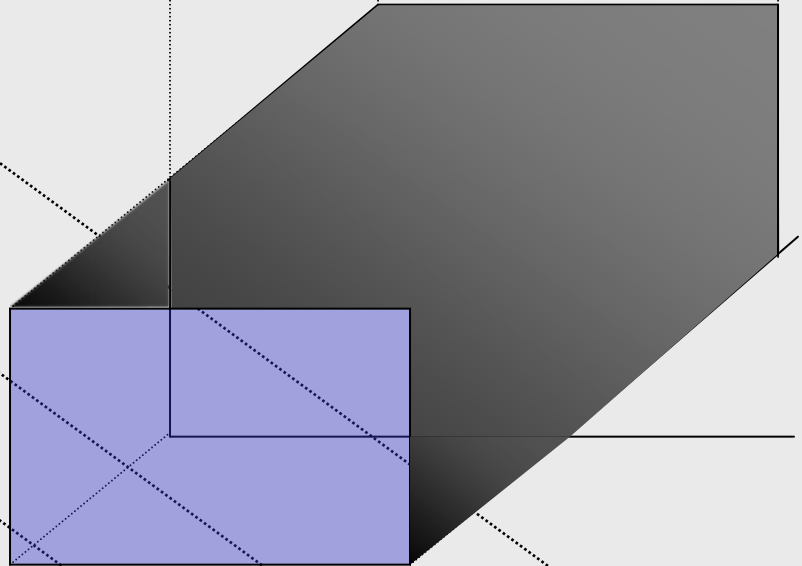
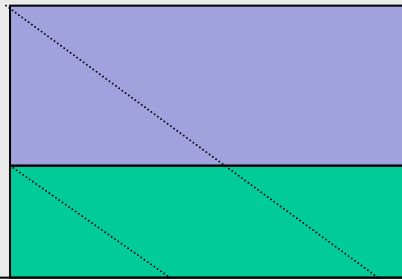

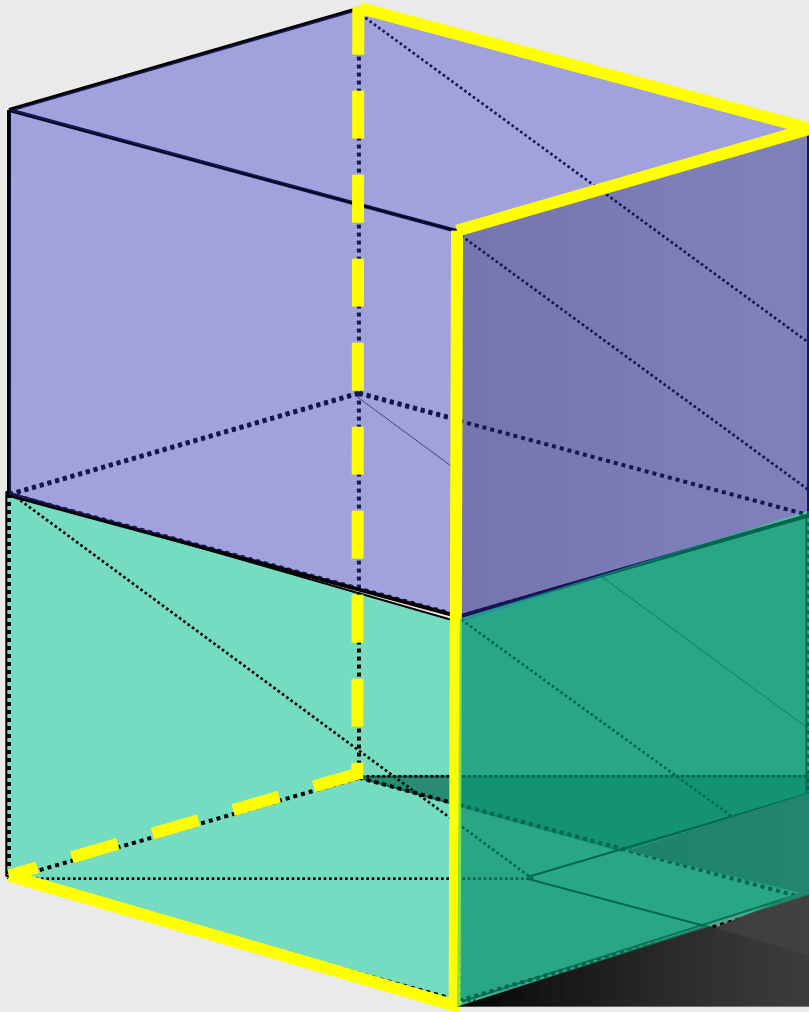

LT

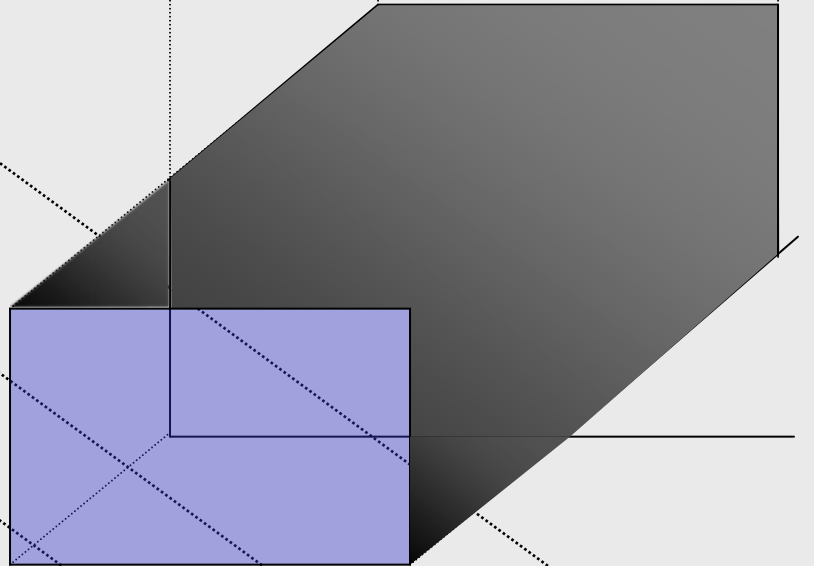
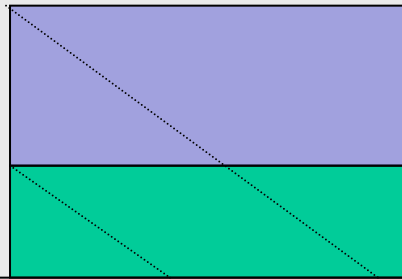

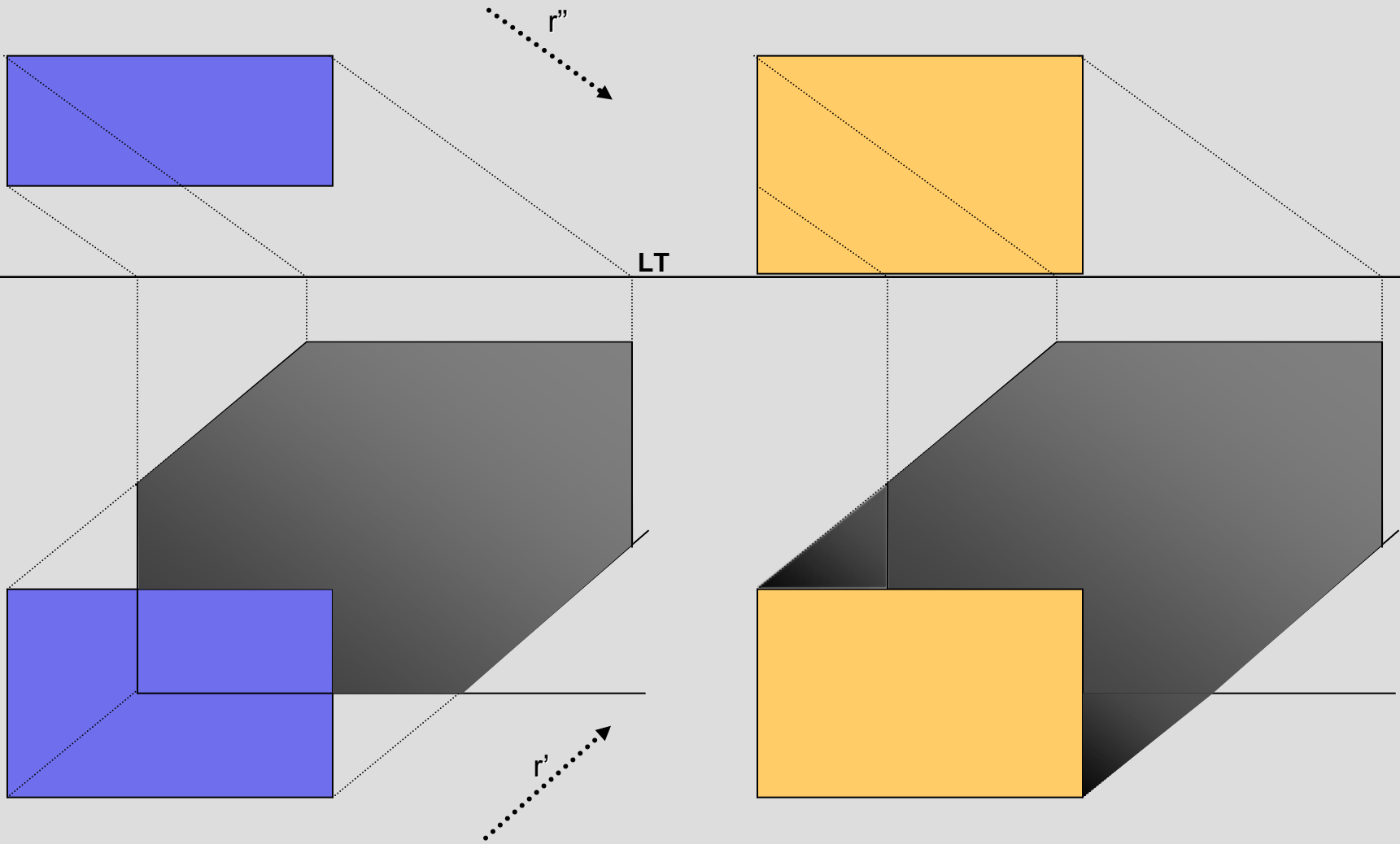

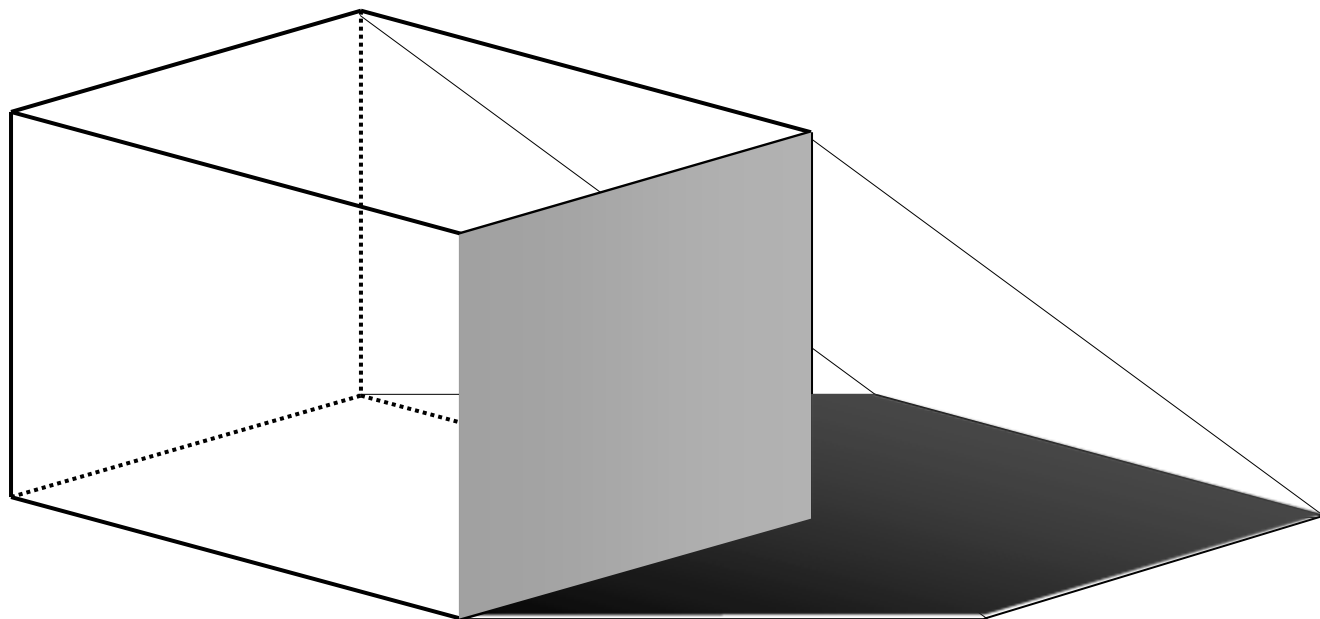

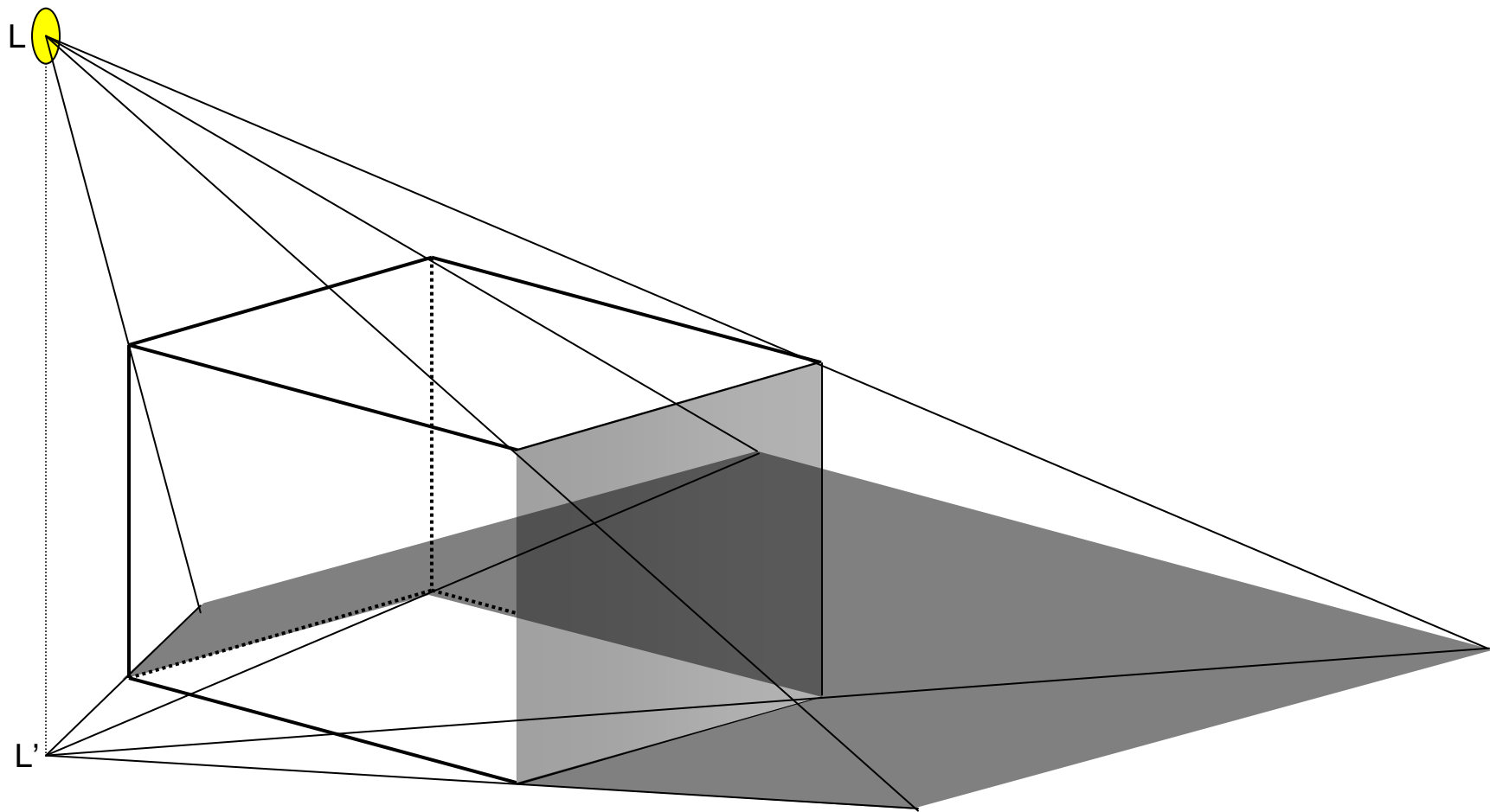

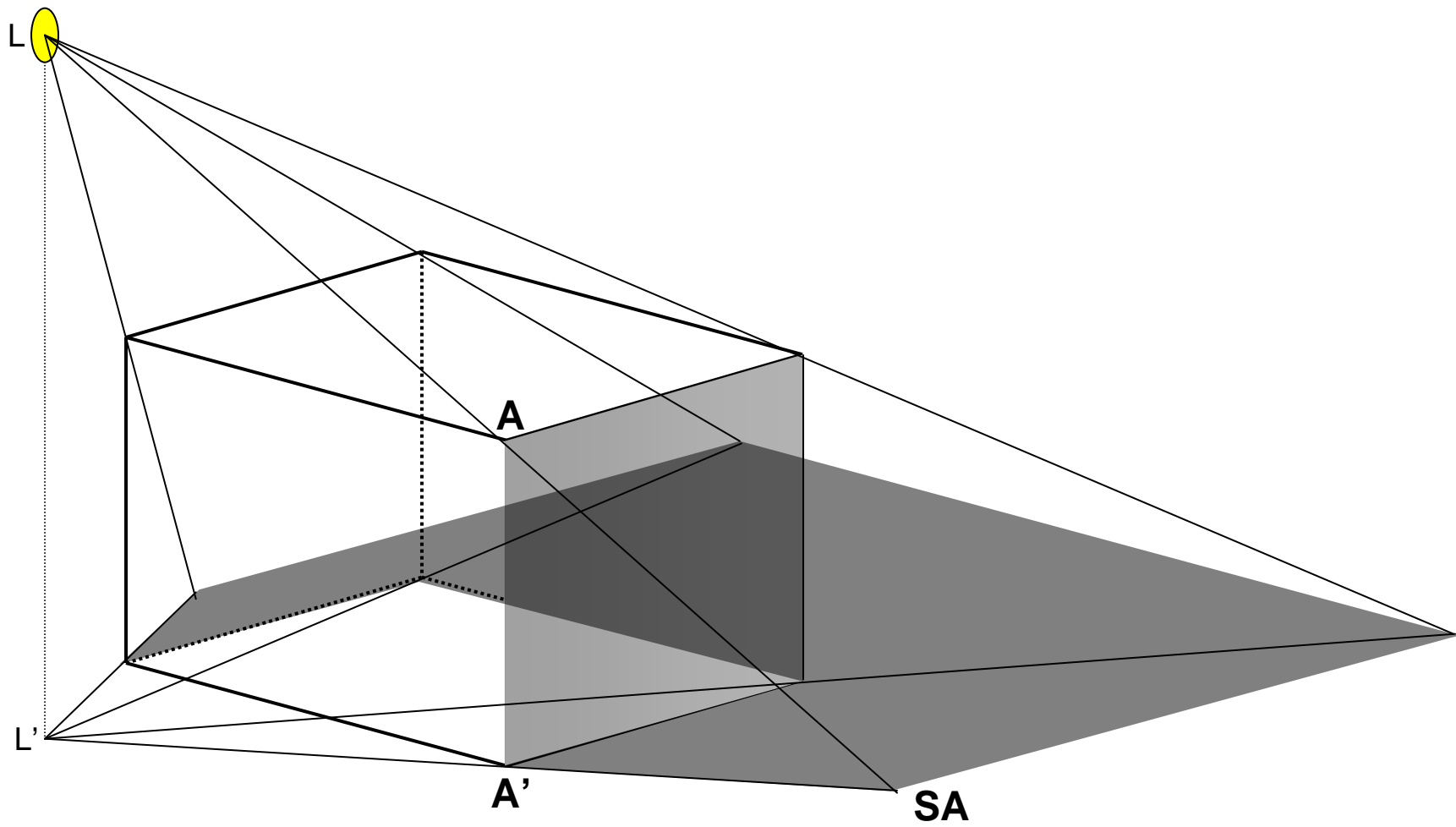

AXONOMETRÍA

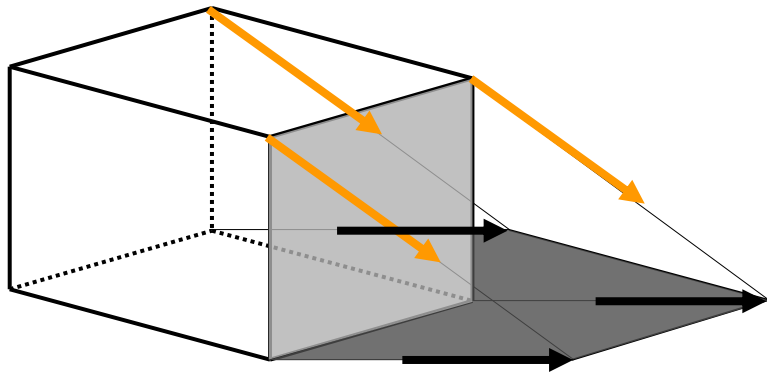

FOCO LUMINOSO NATURAL

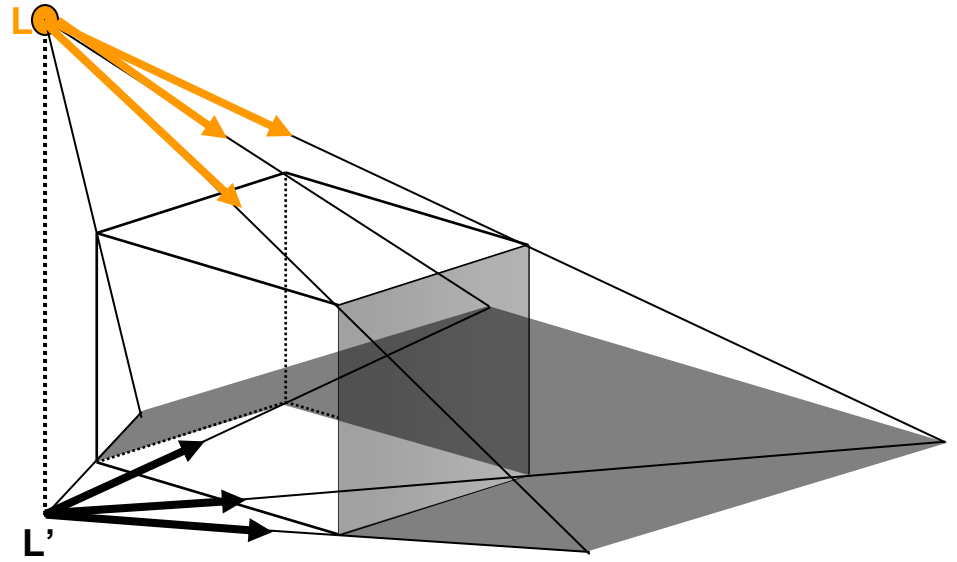

FOCO LUMINOSO ARTIFICIAL

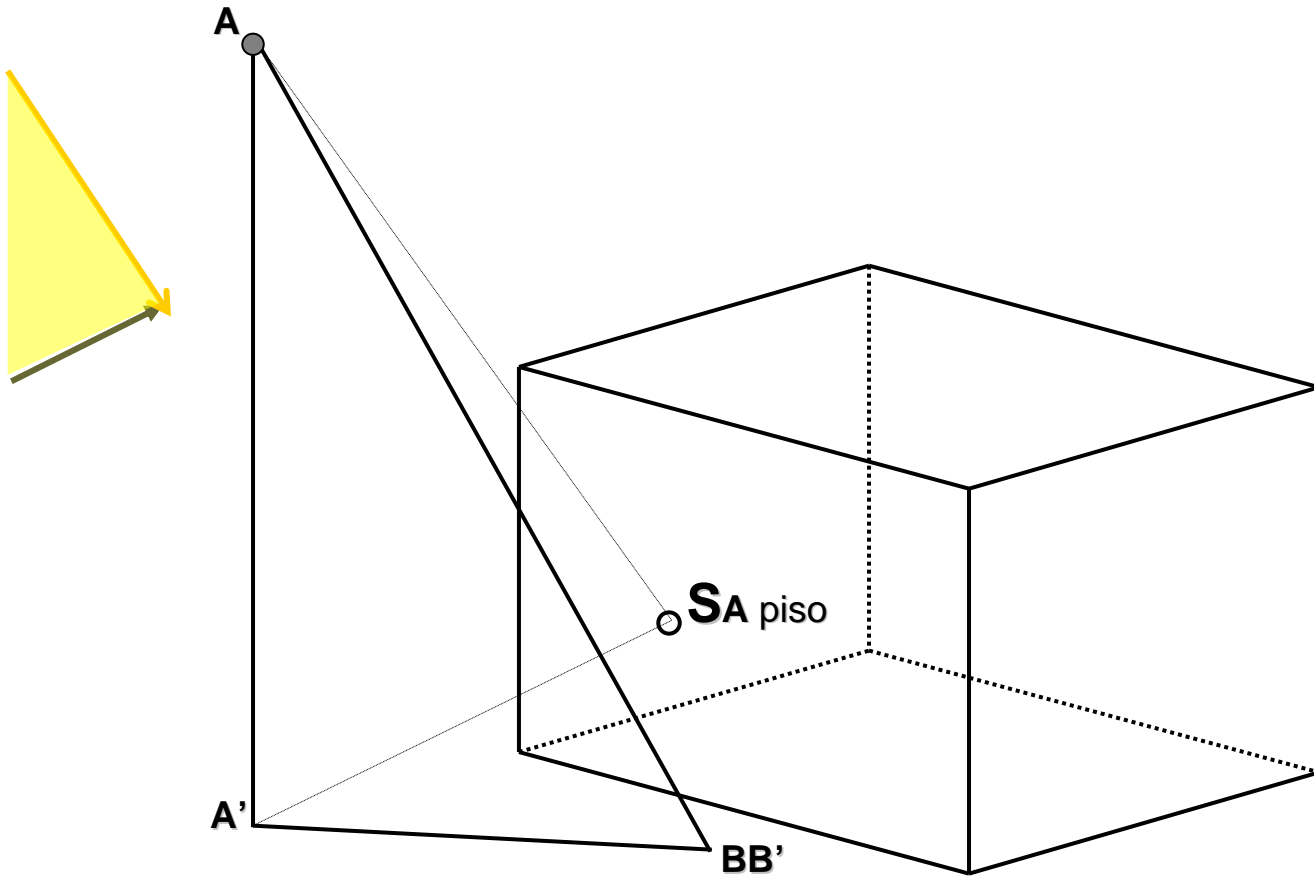

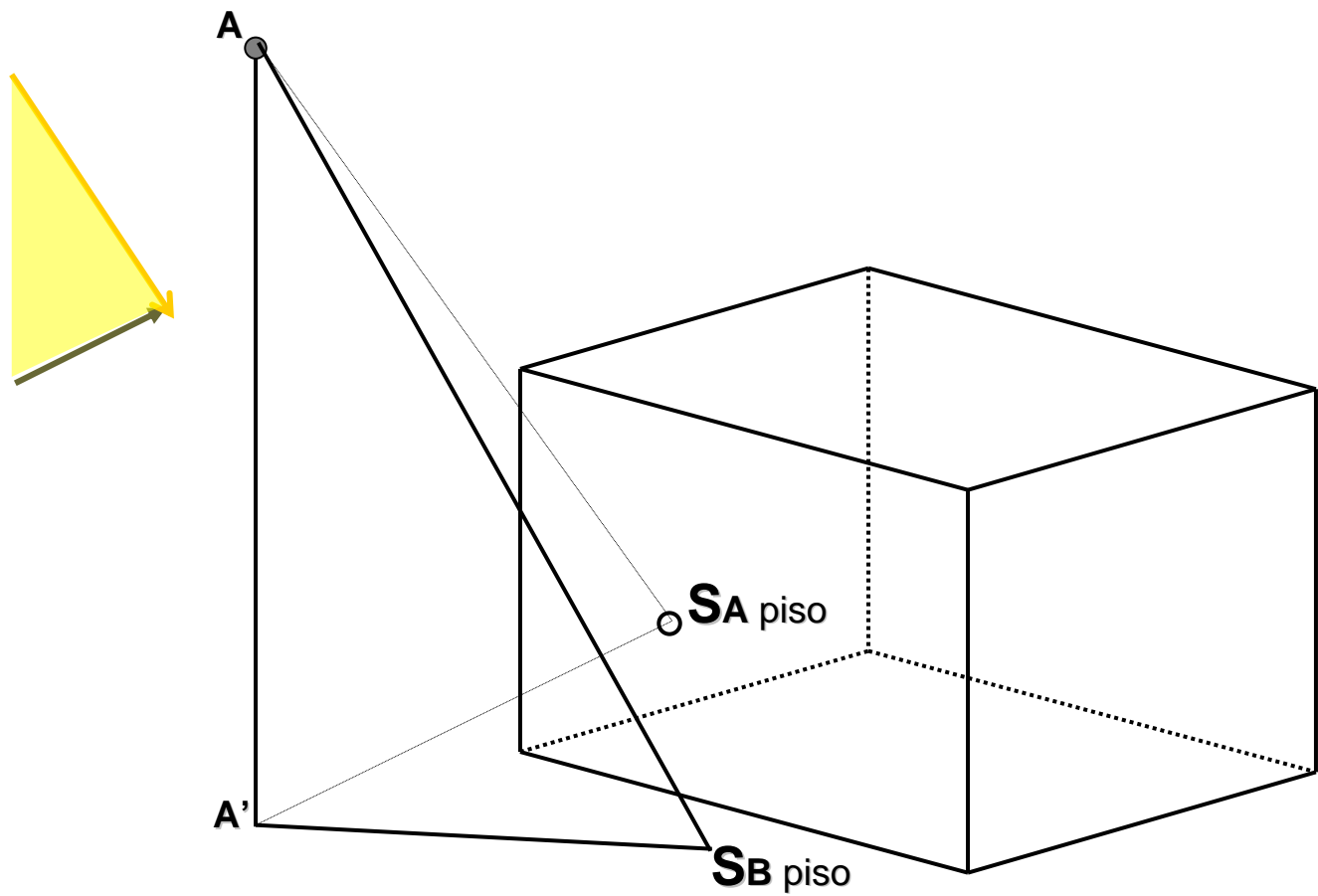

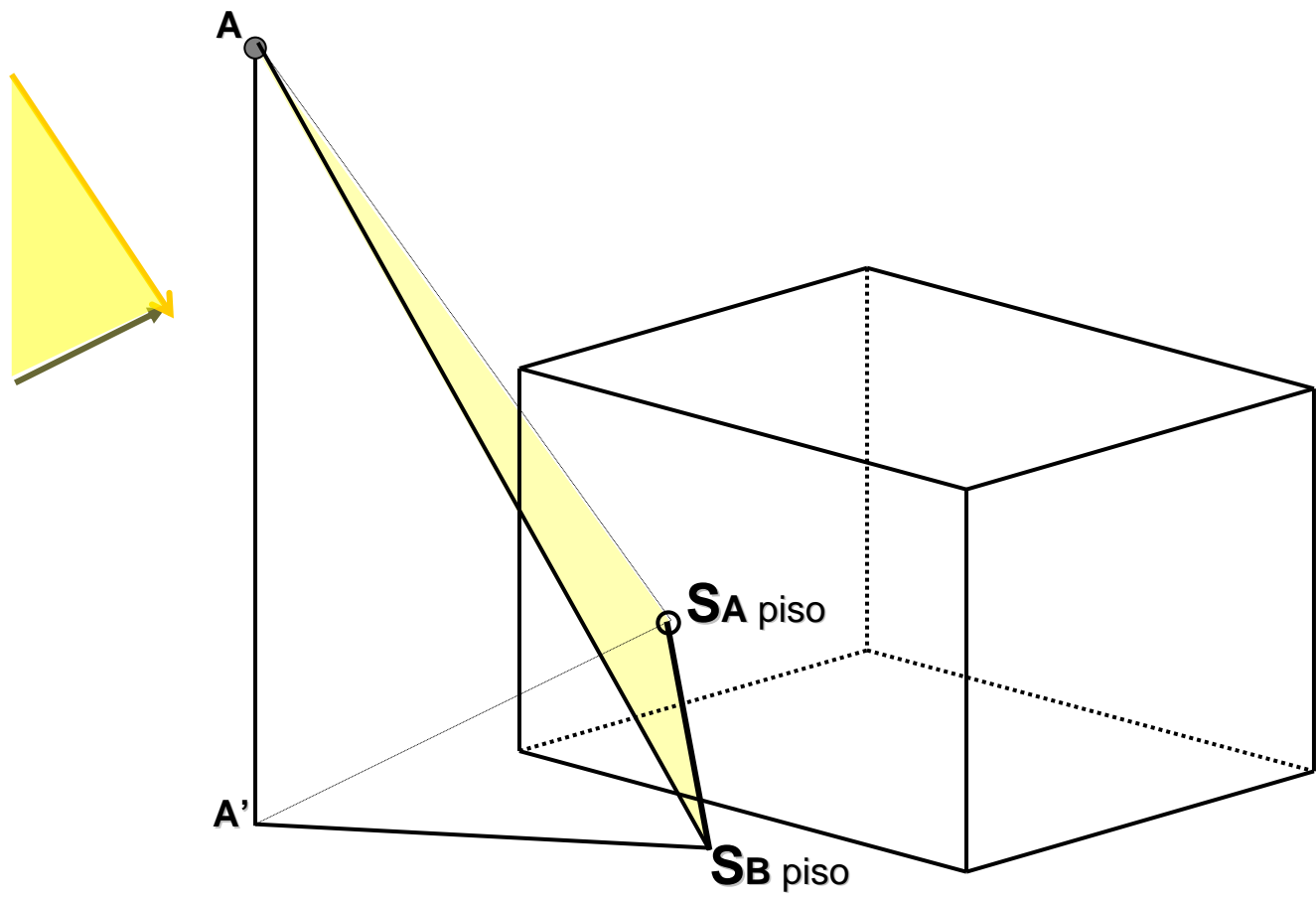

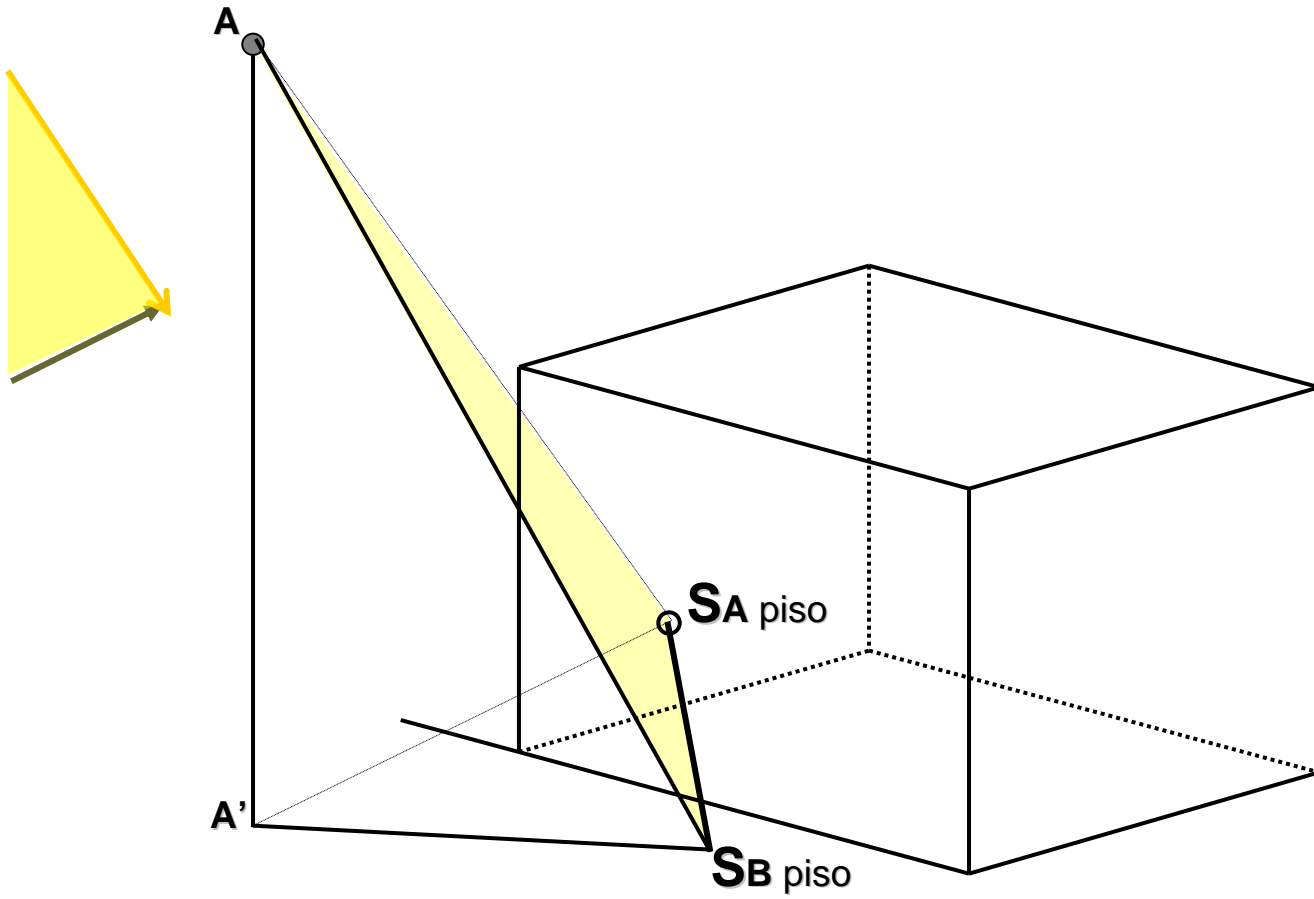

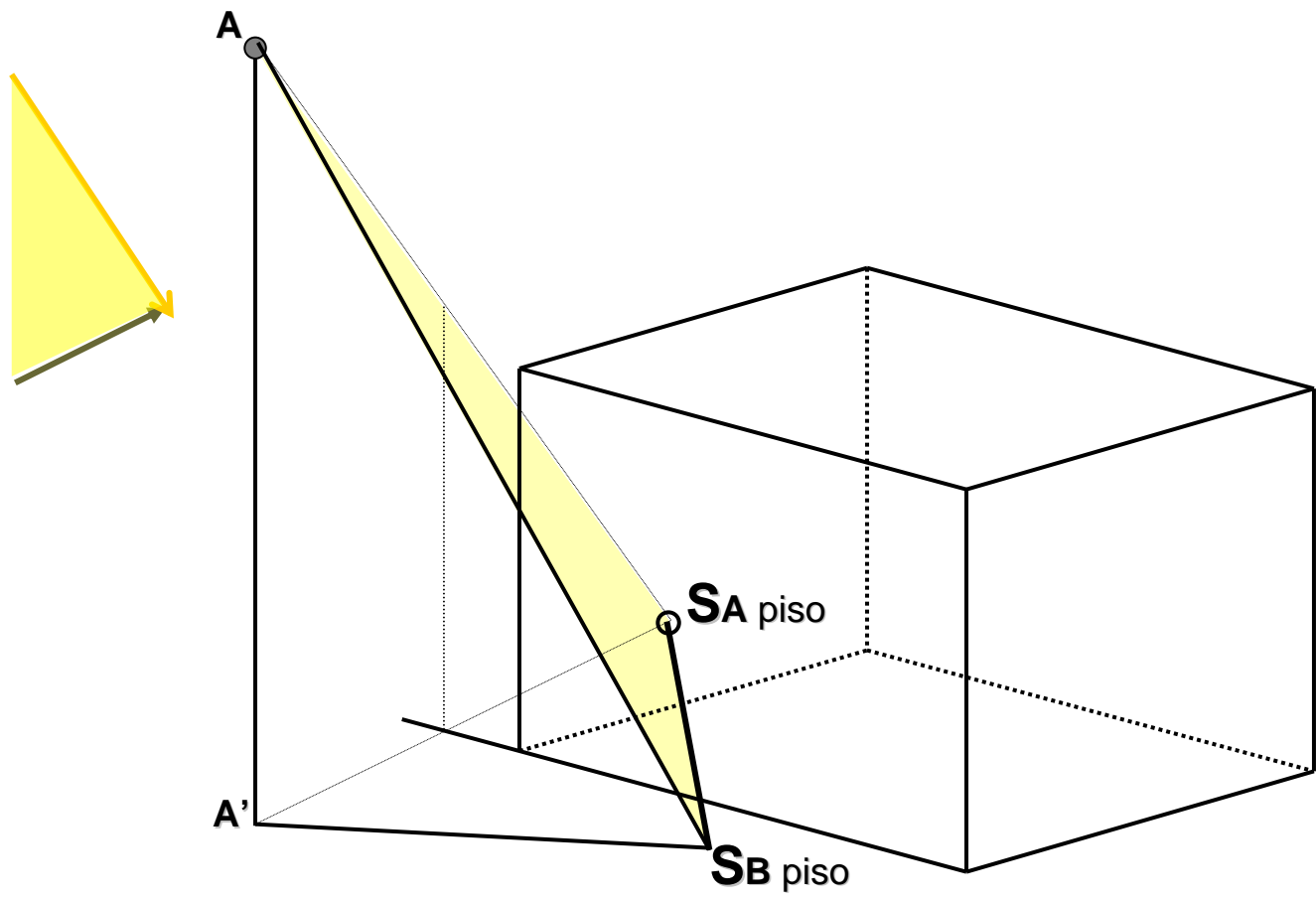

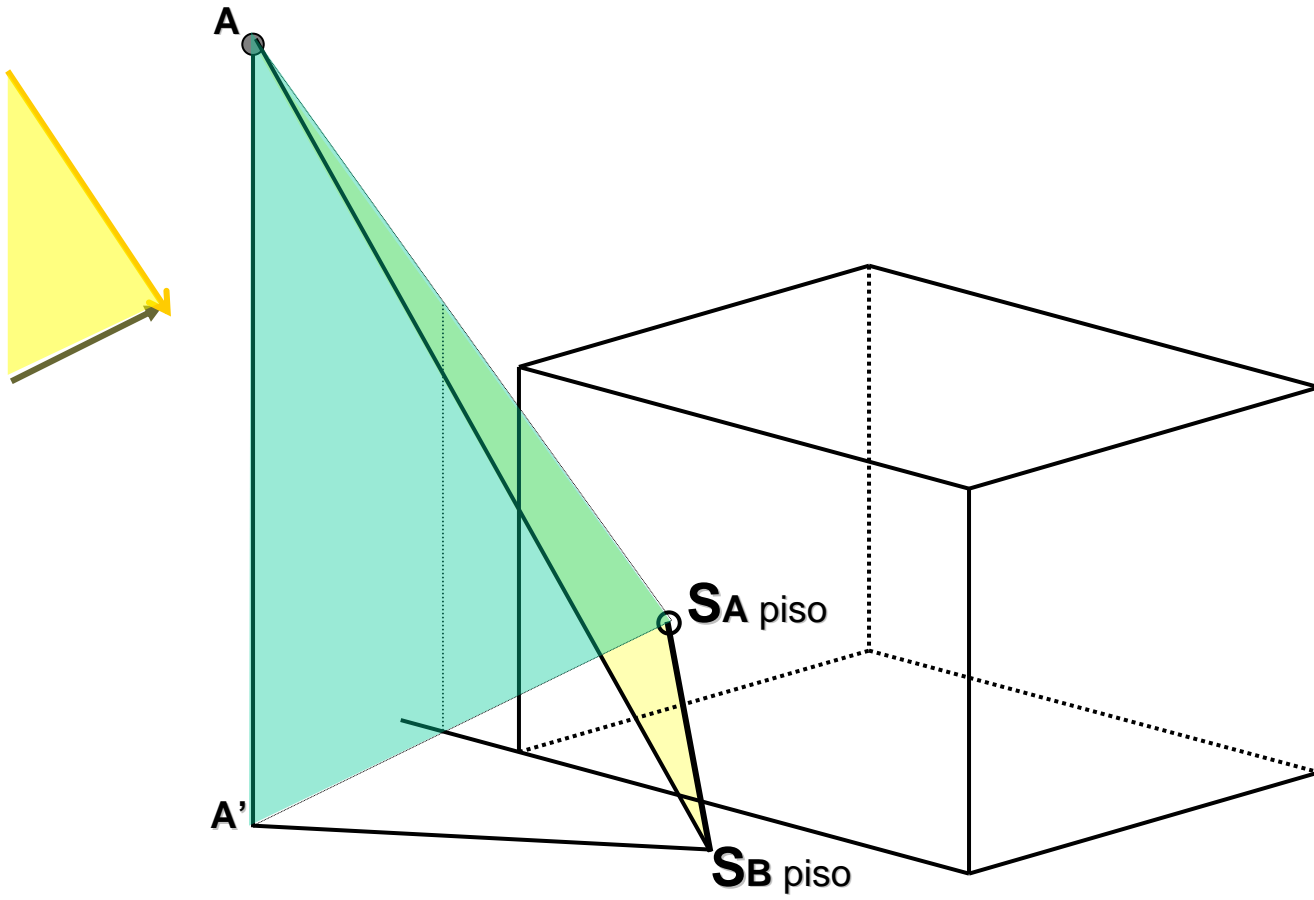

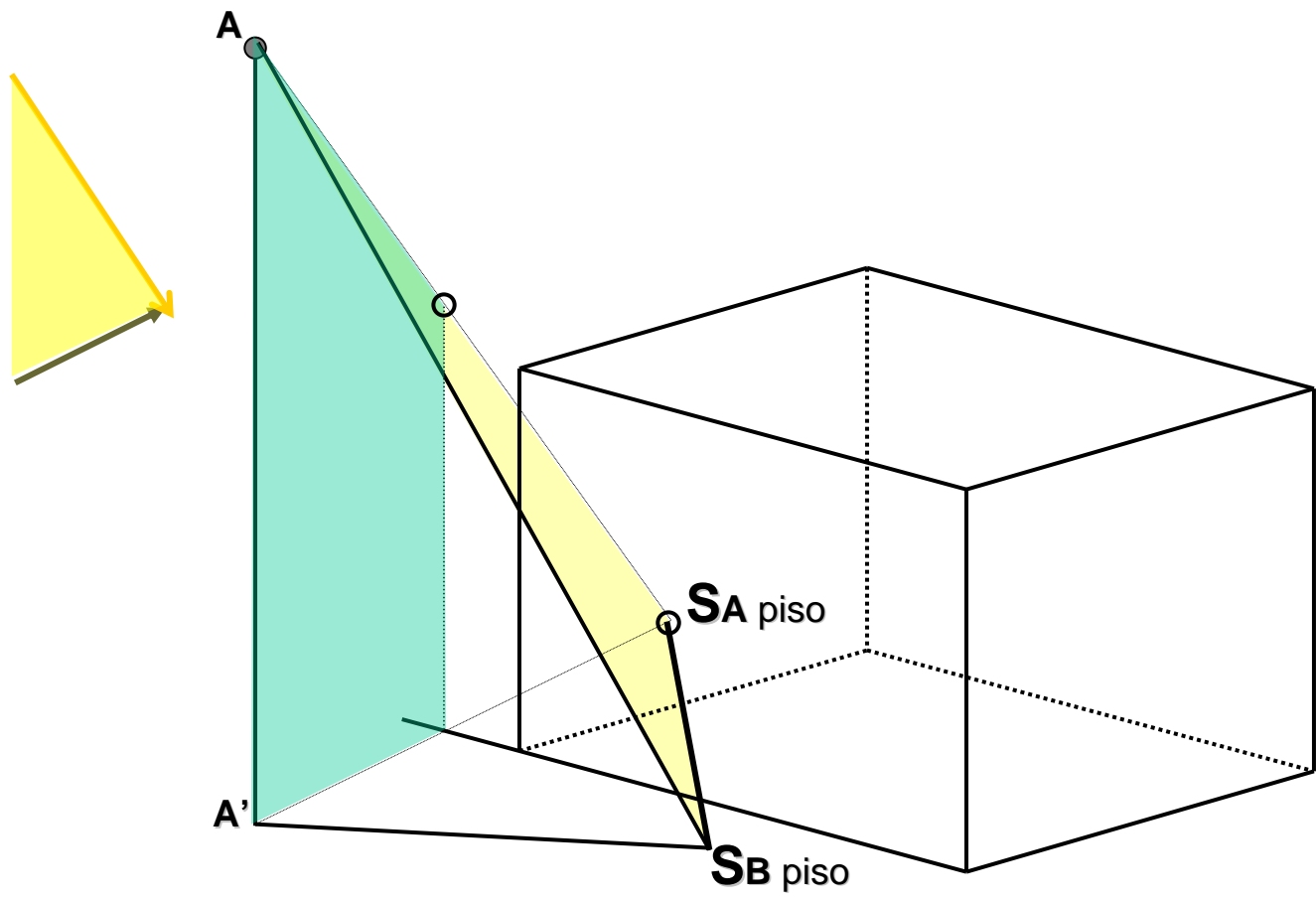

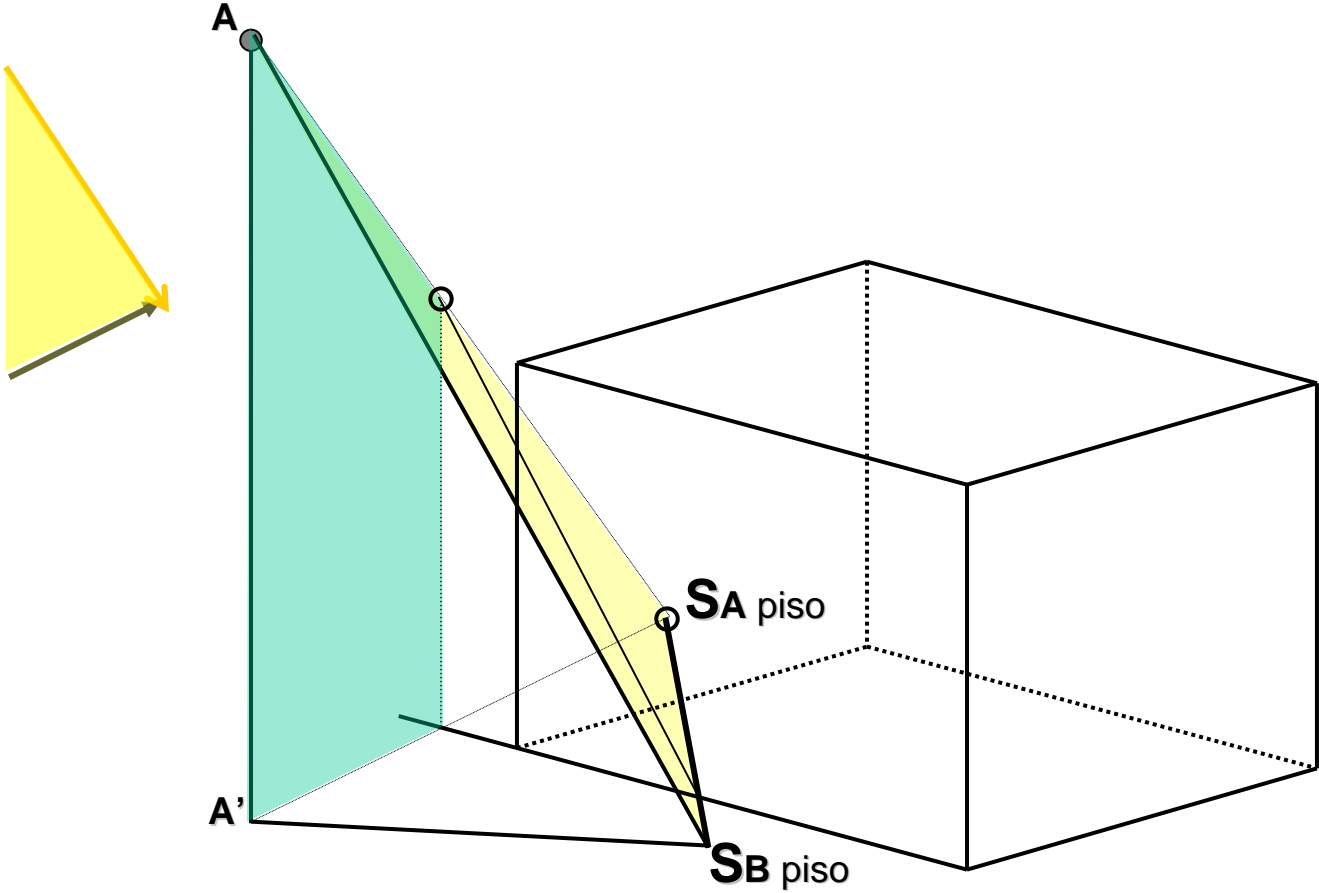

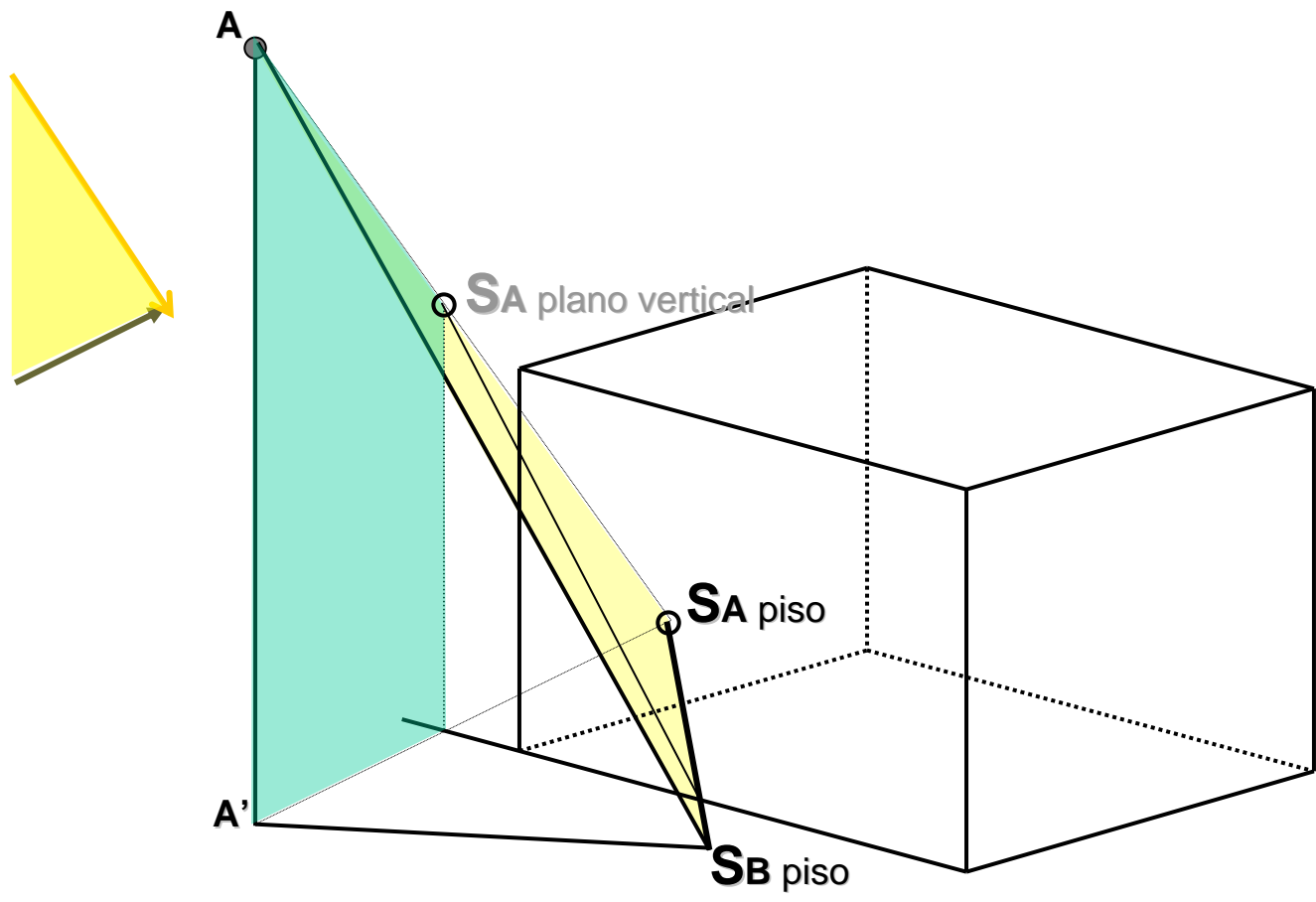

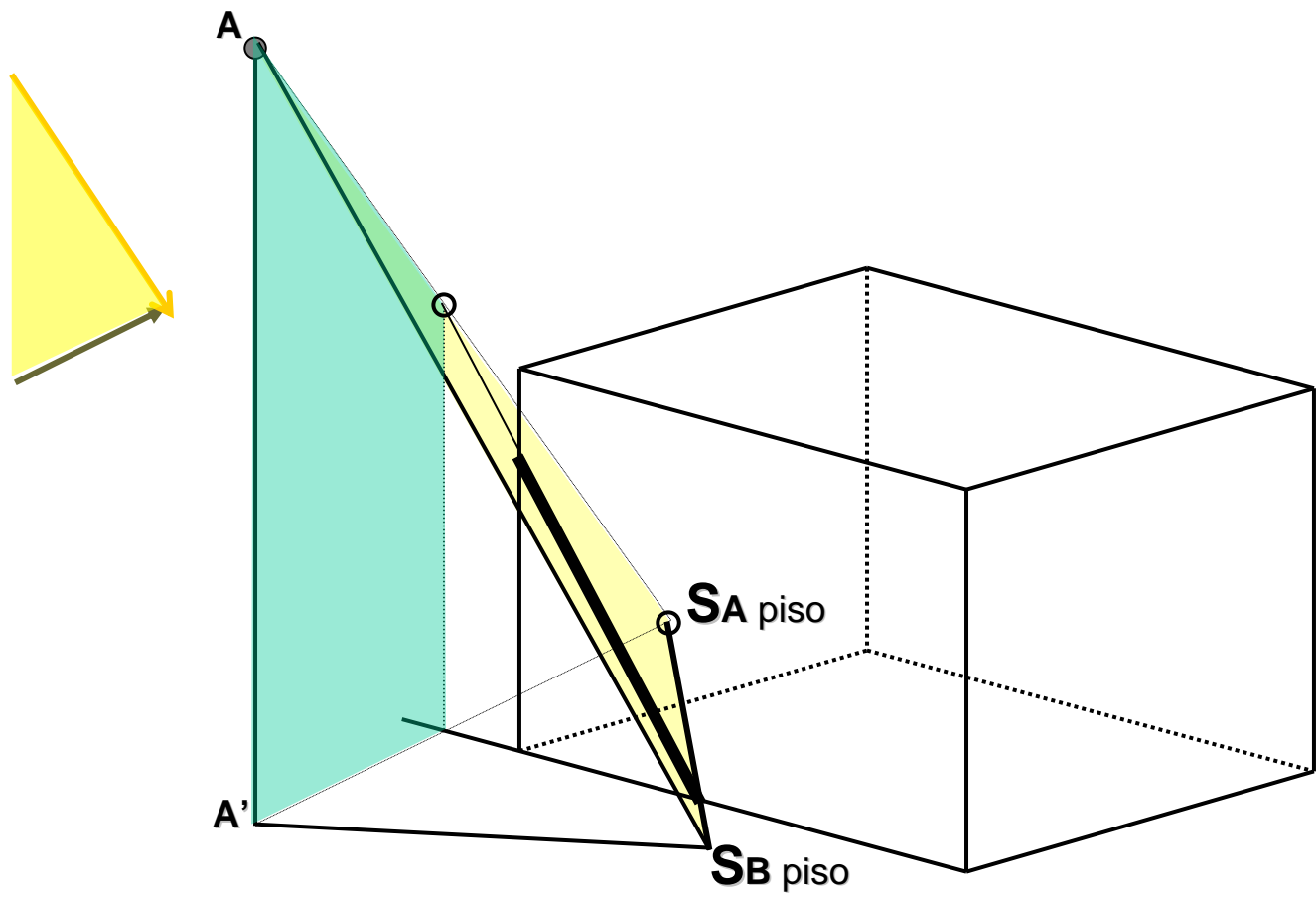

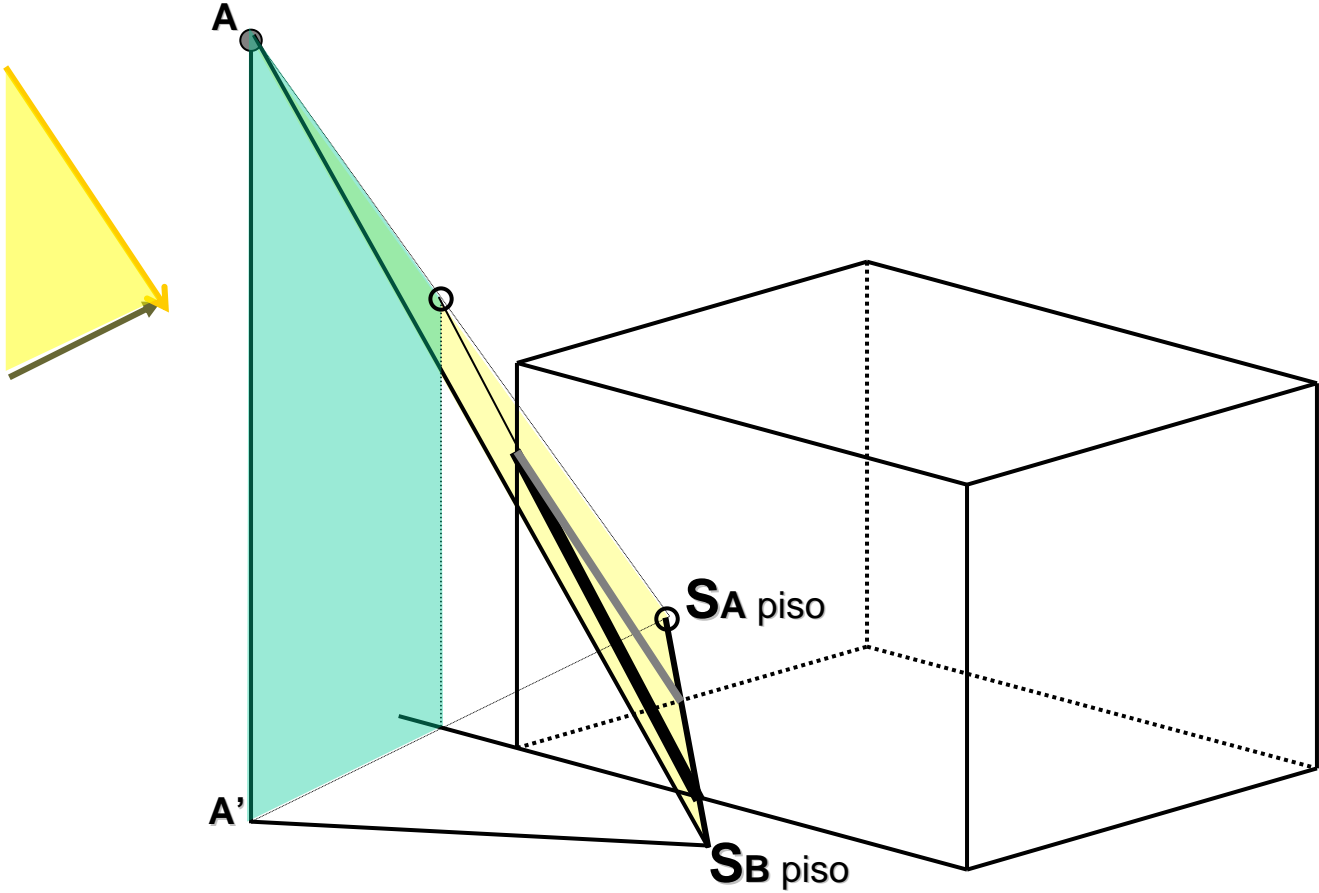

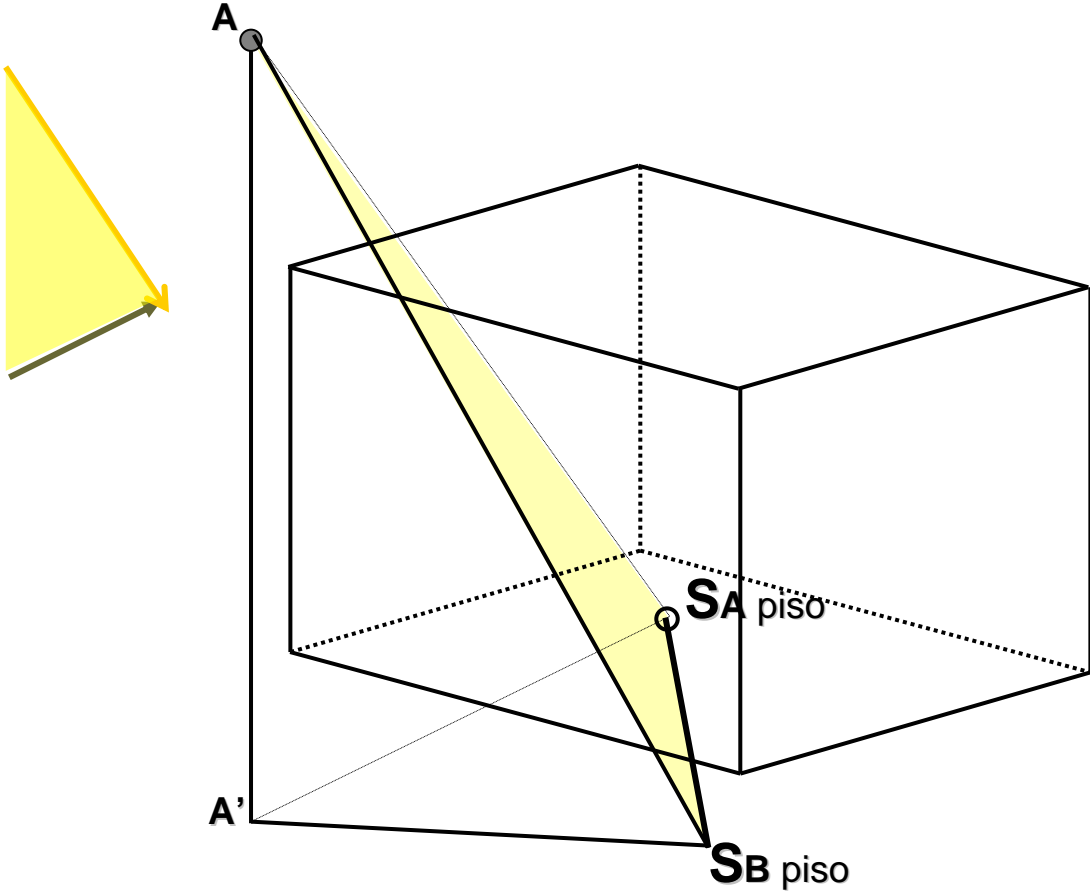

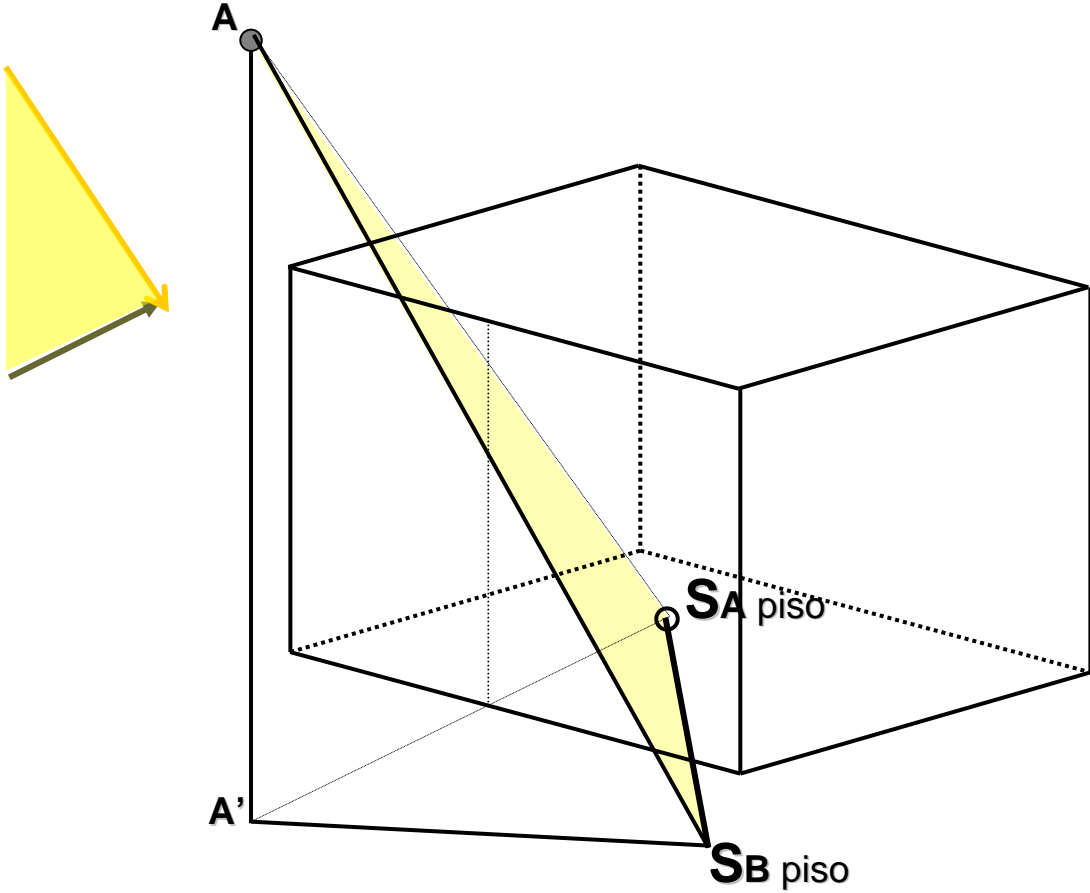

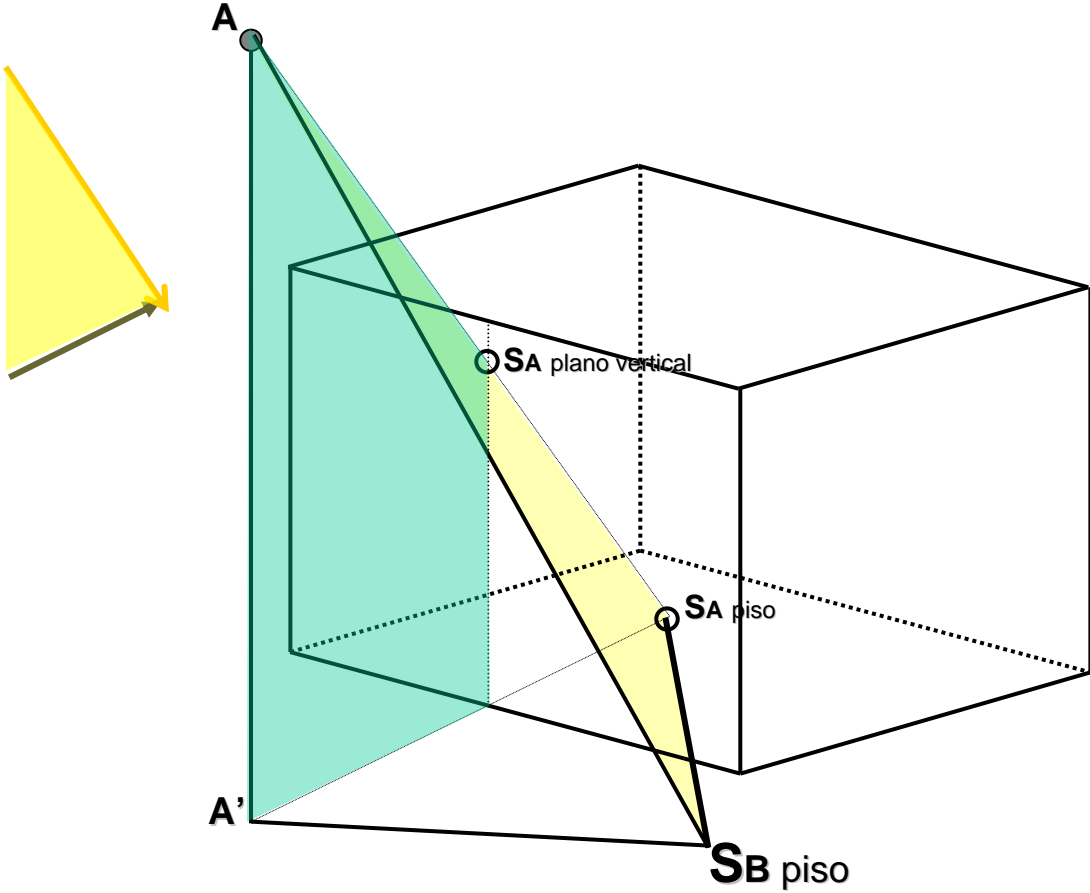

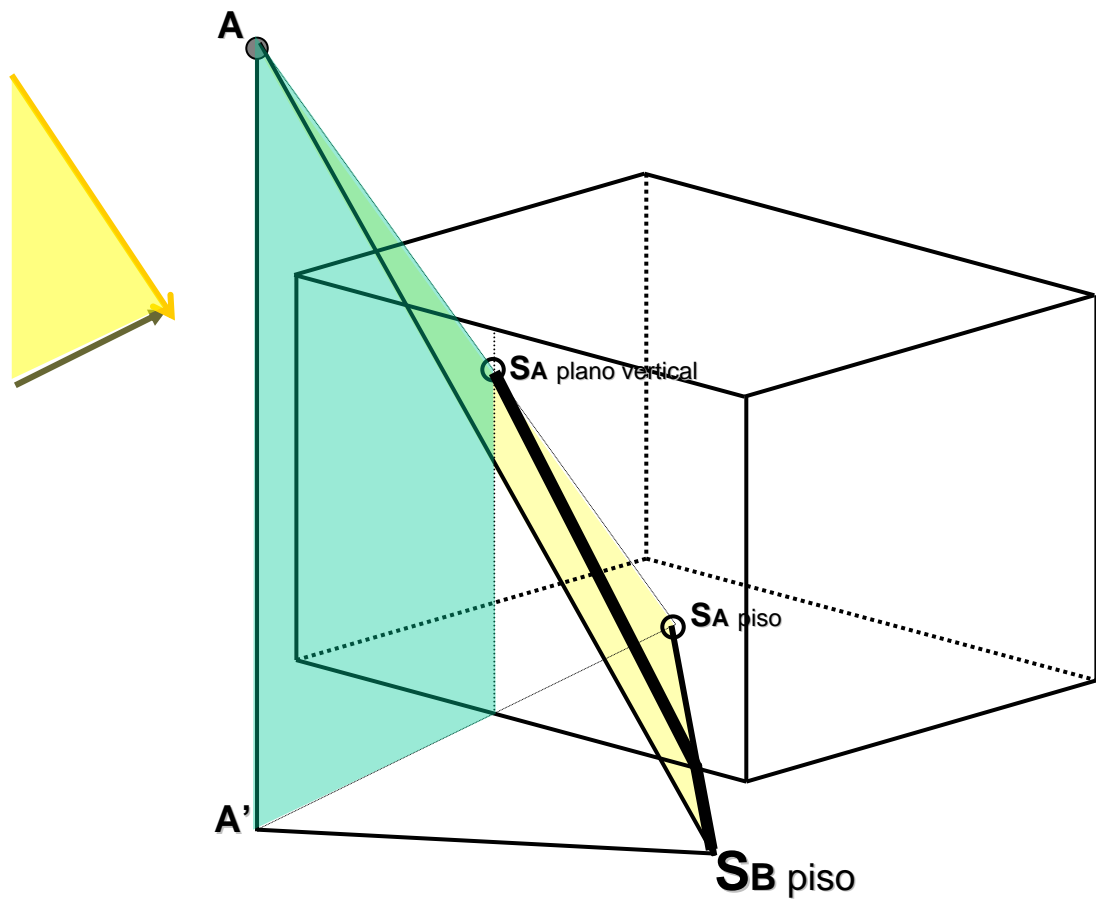

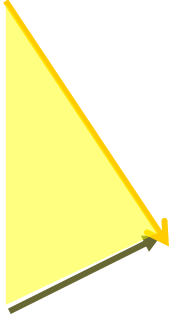
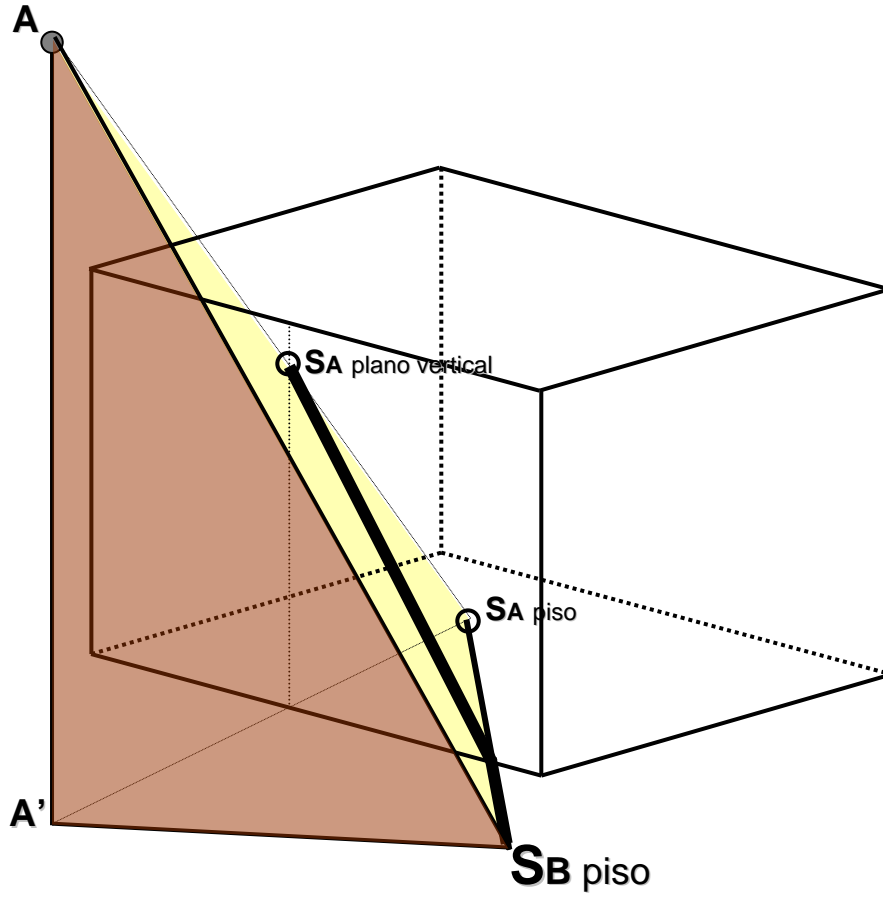

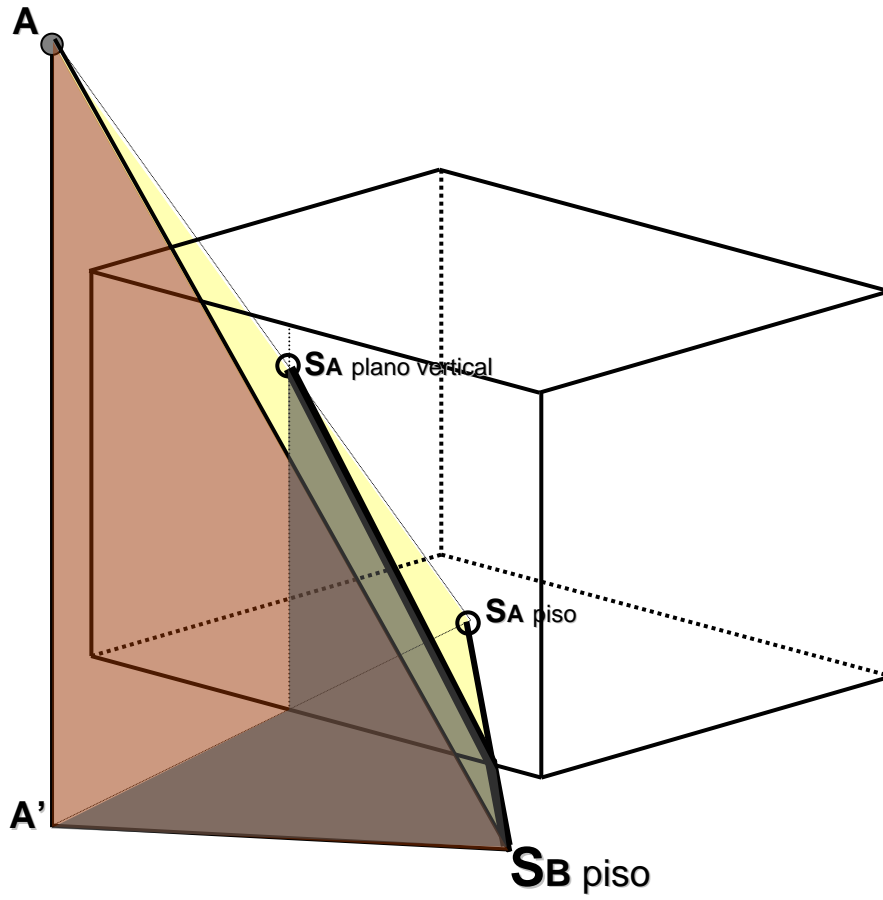

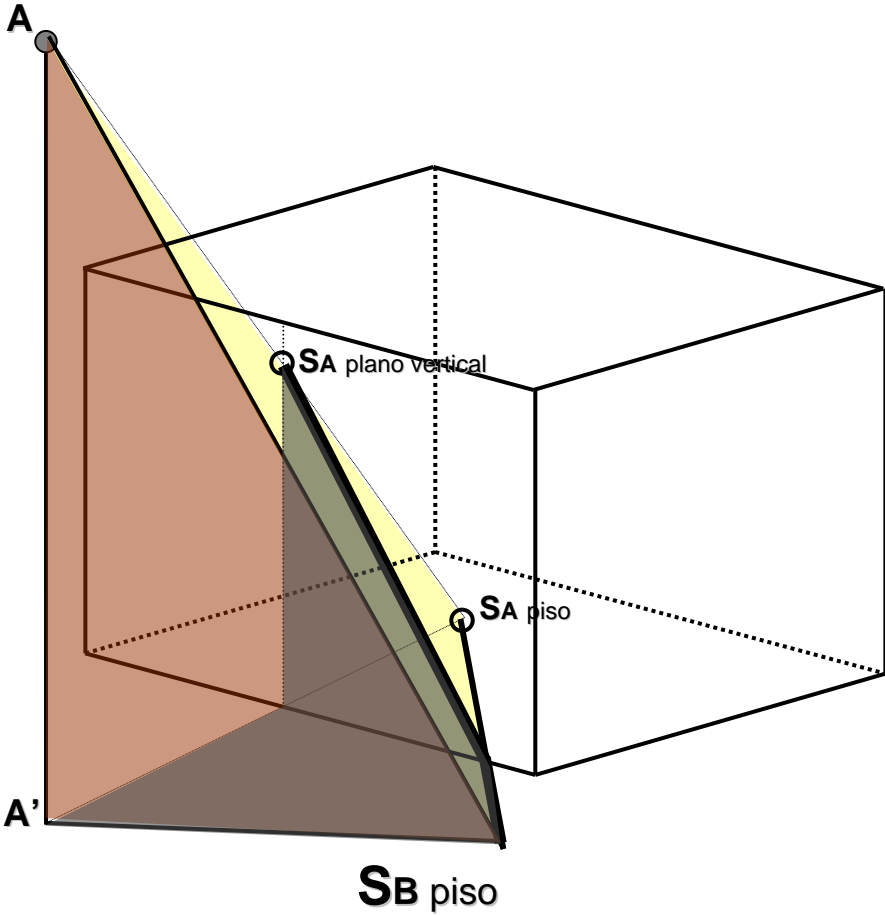

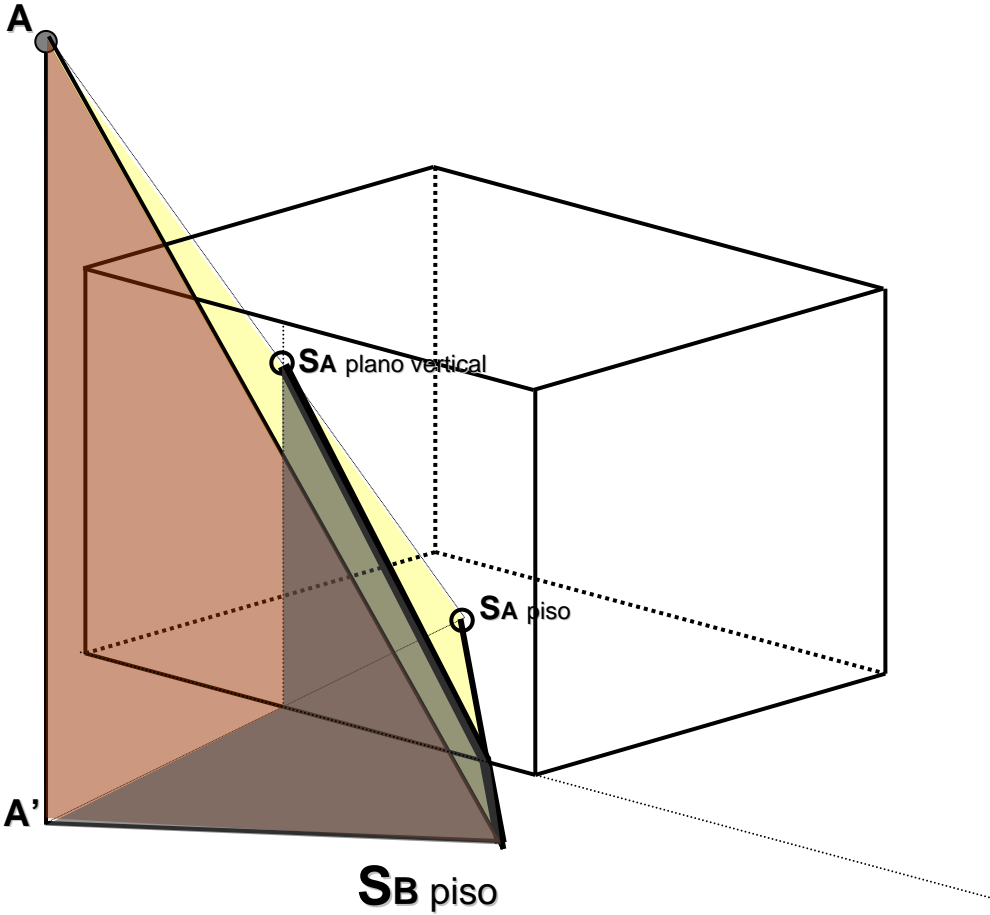

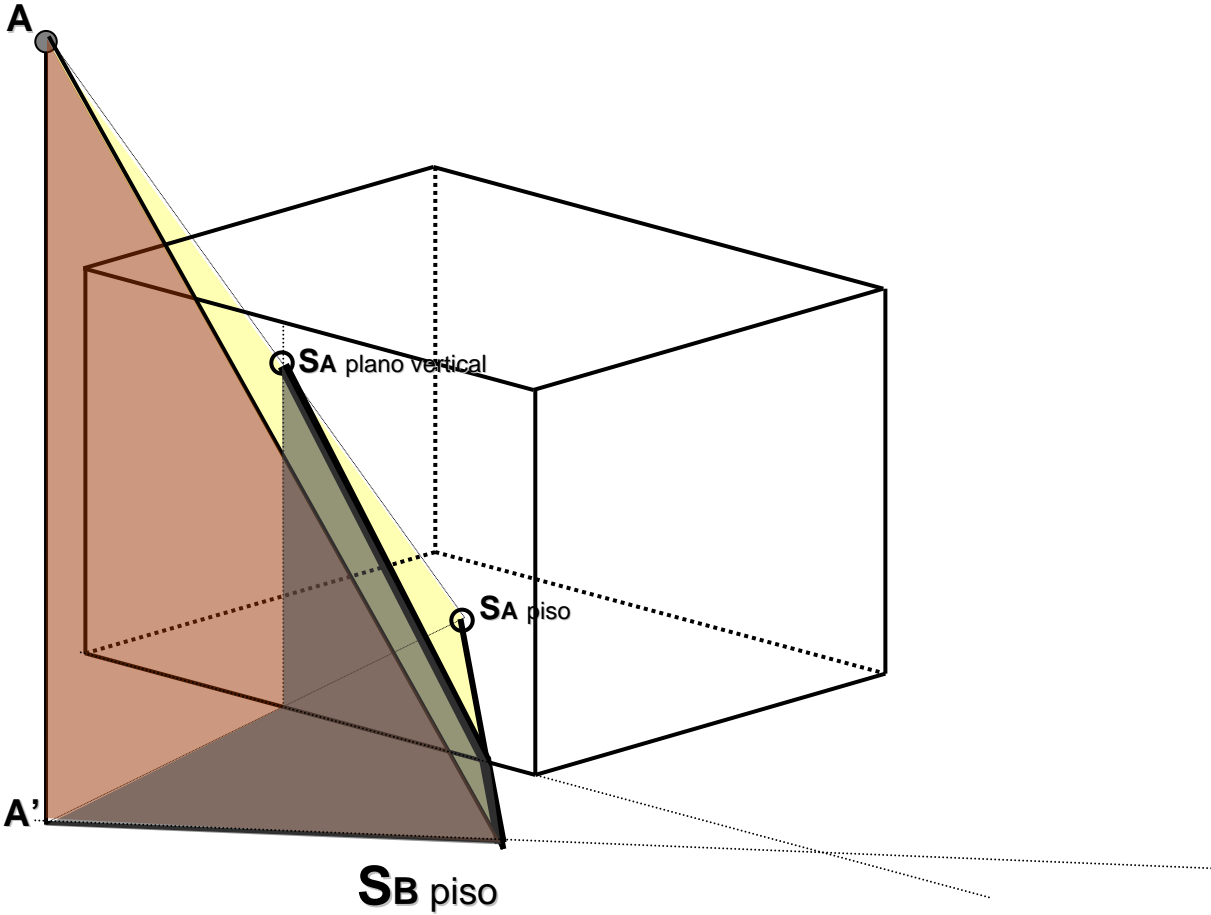

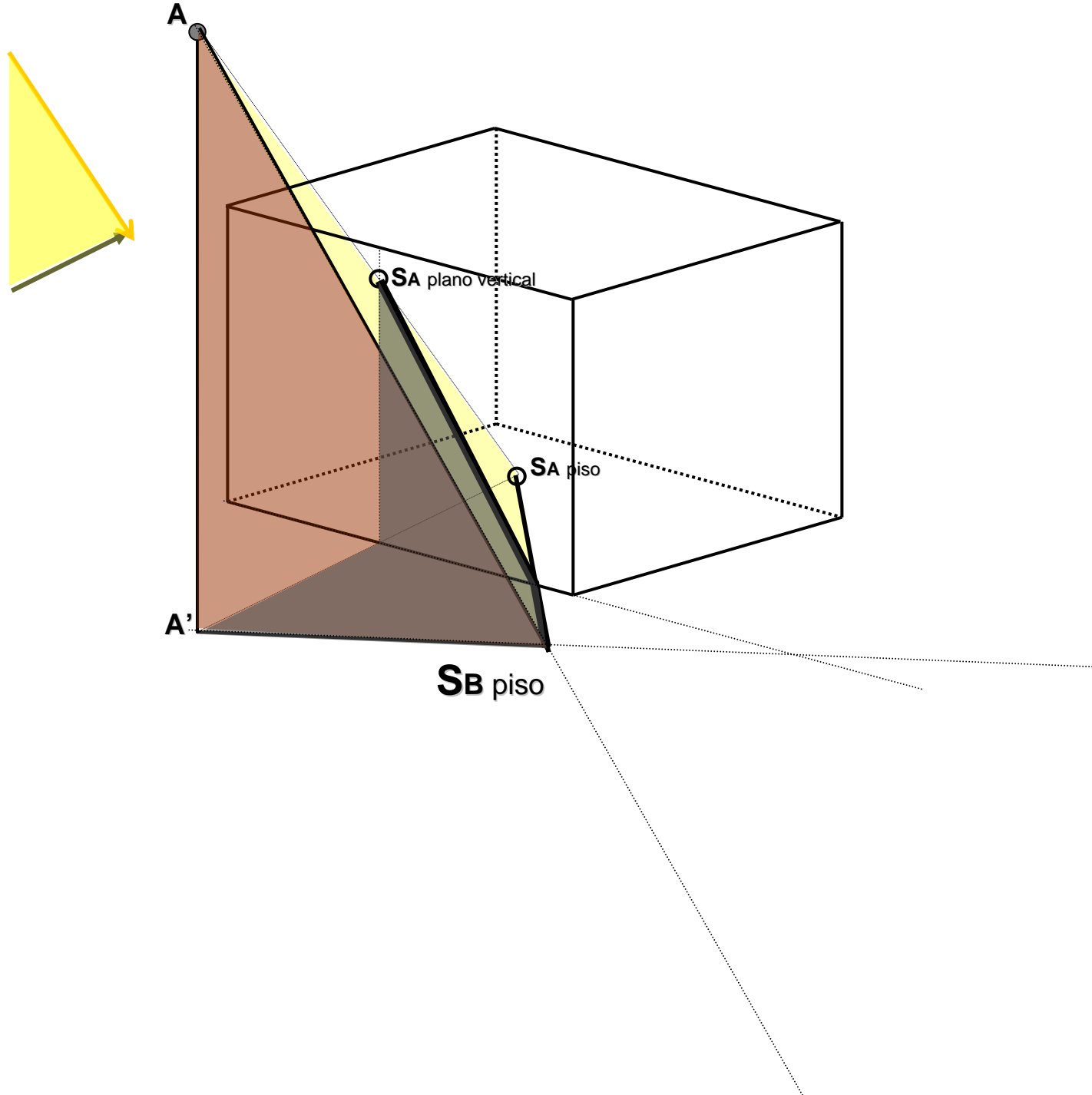

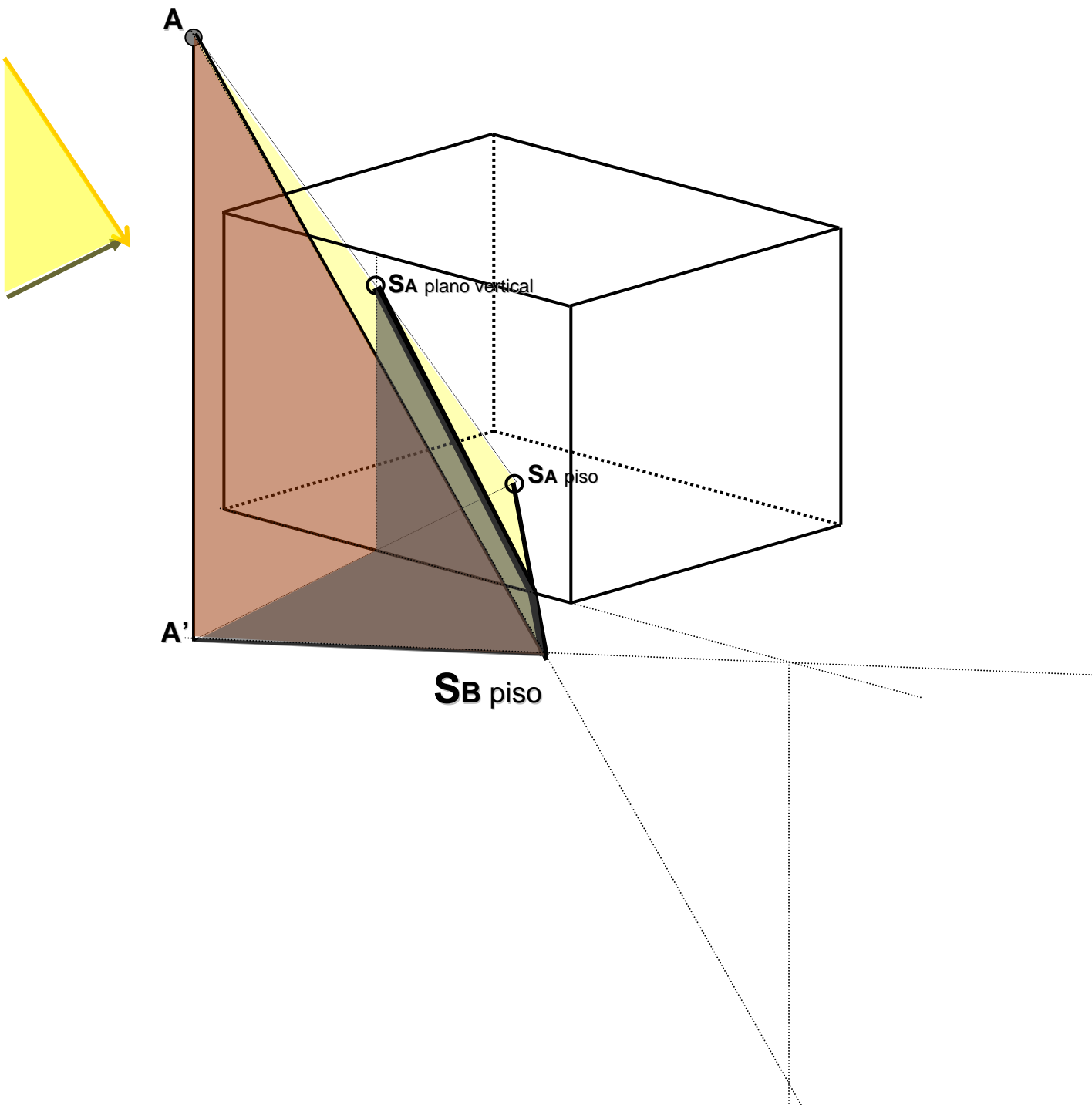

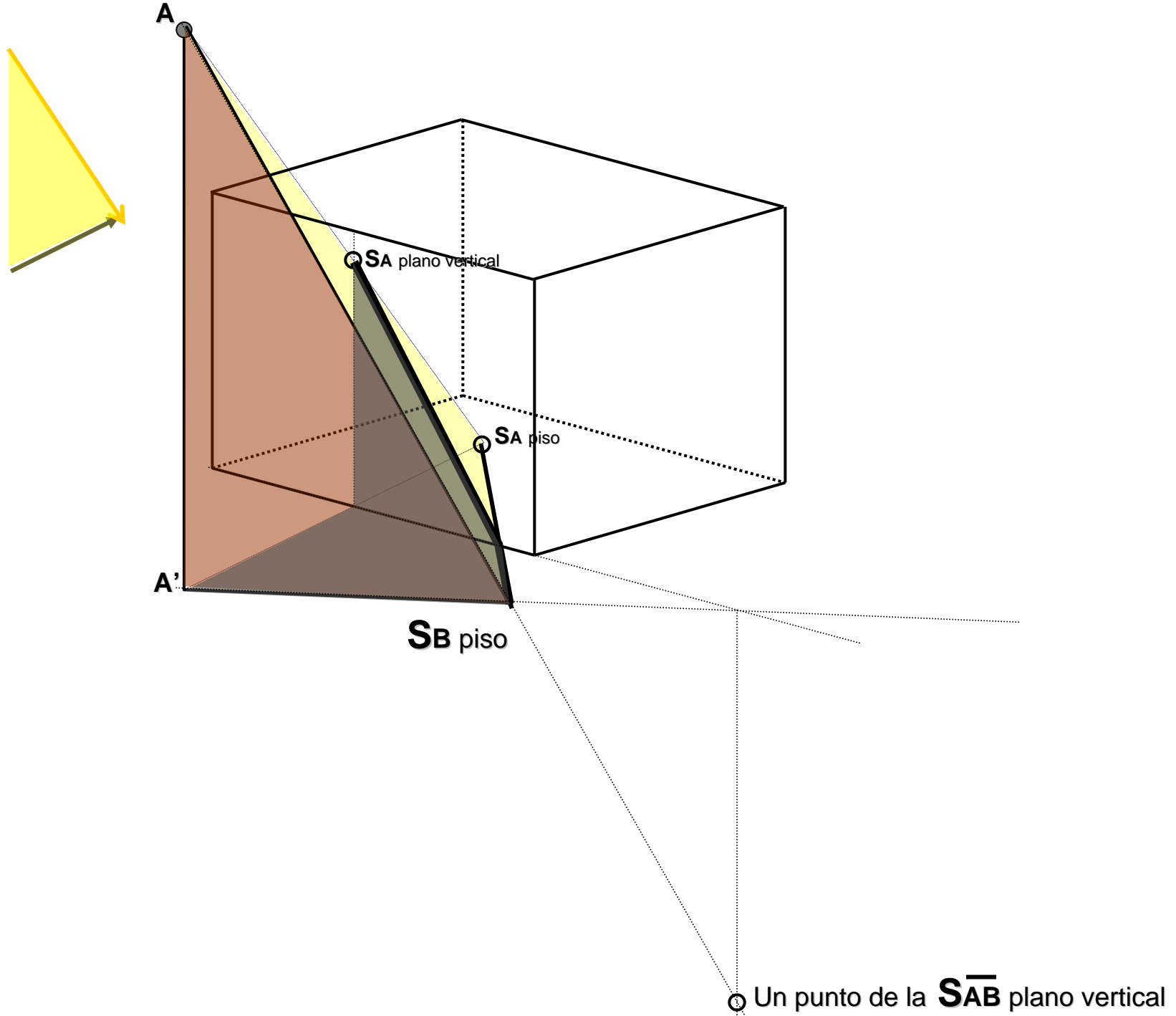

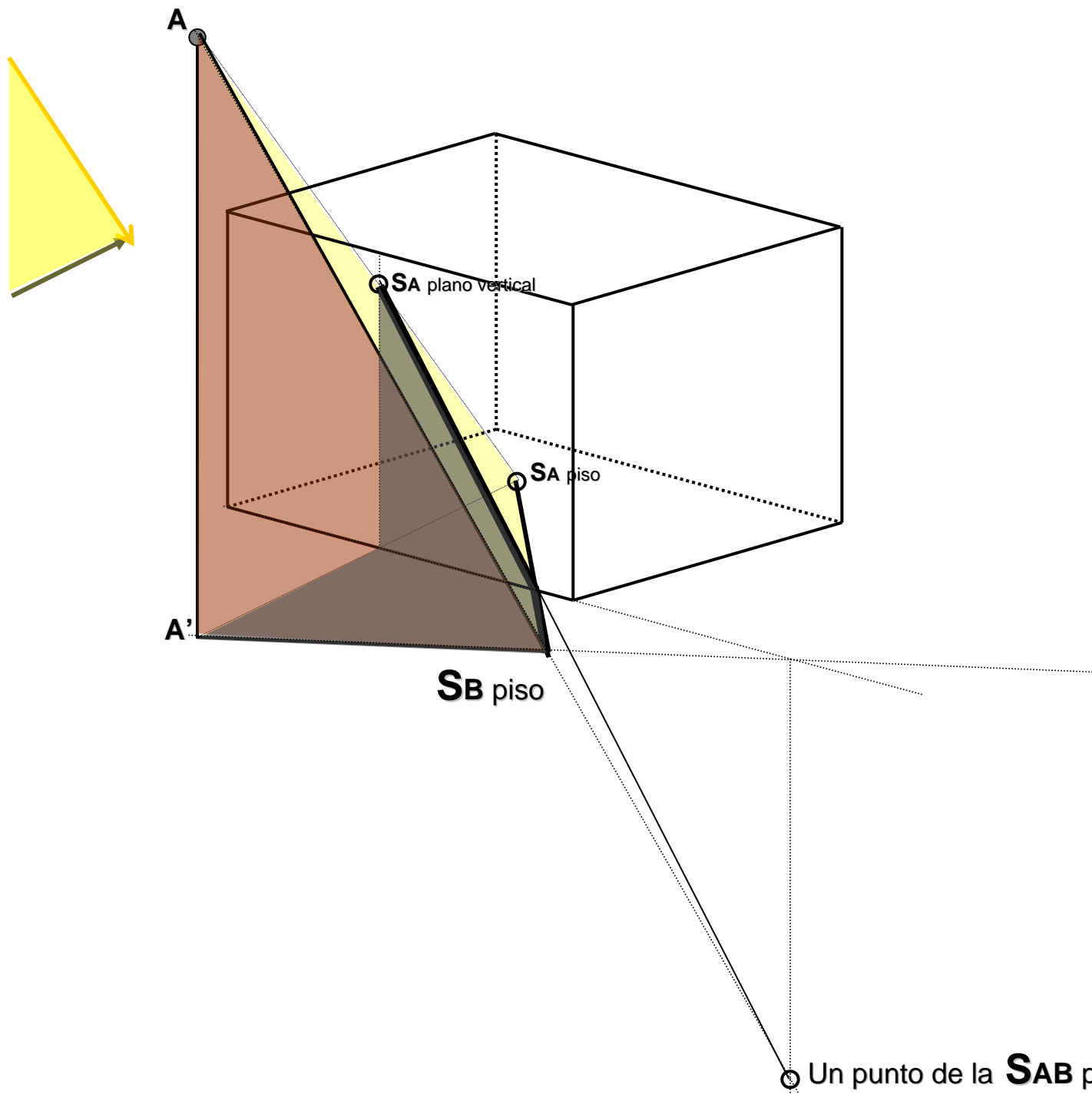

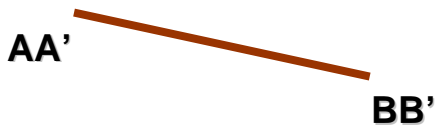
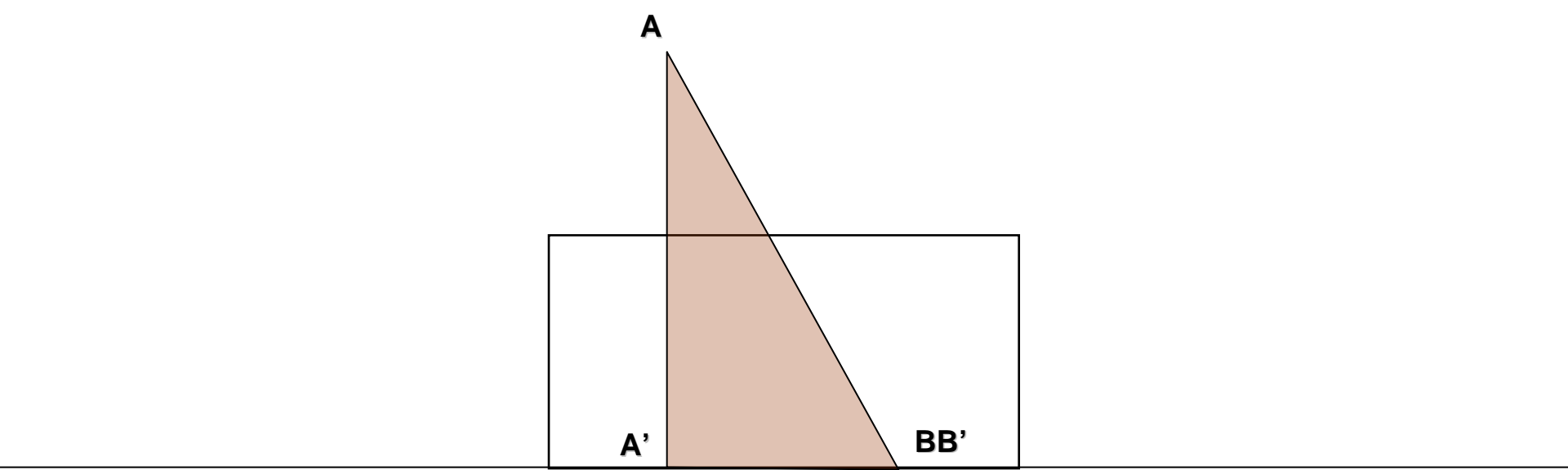

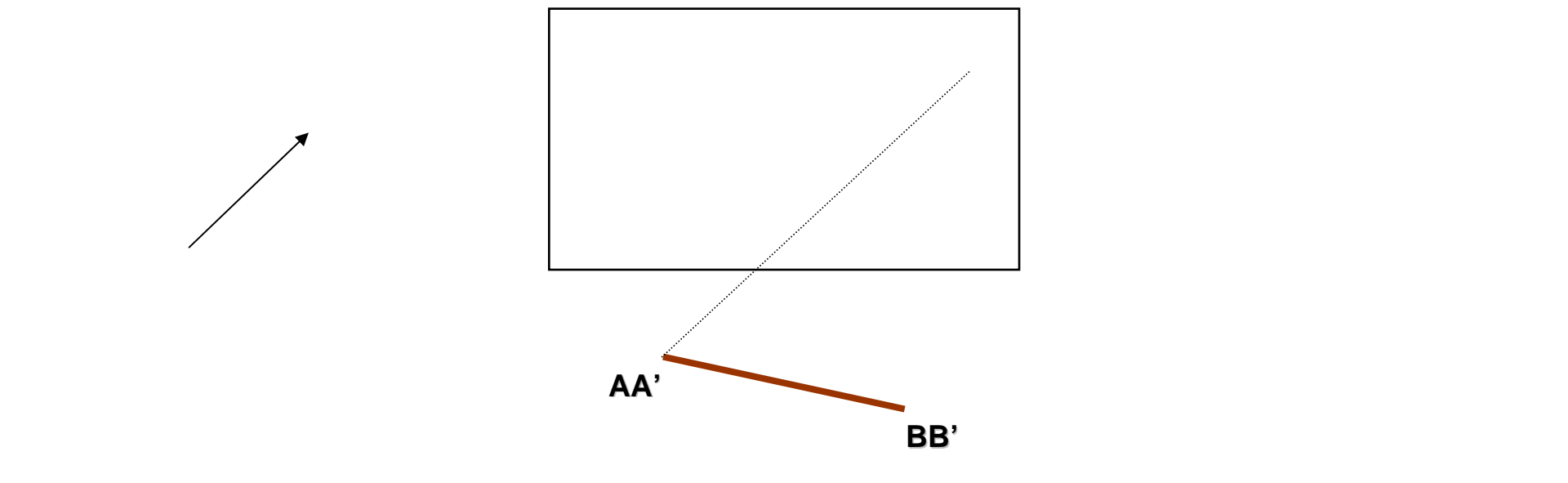
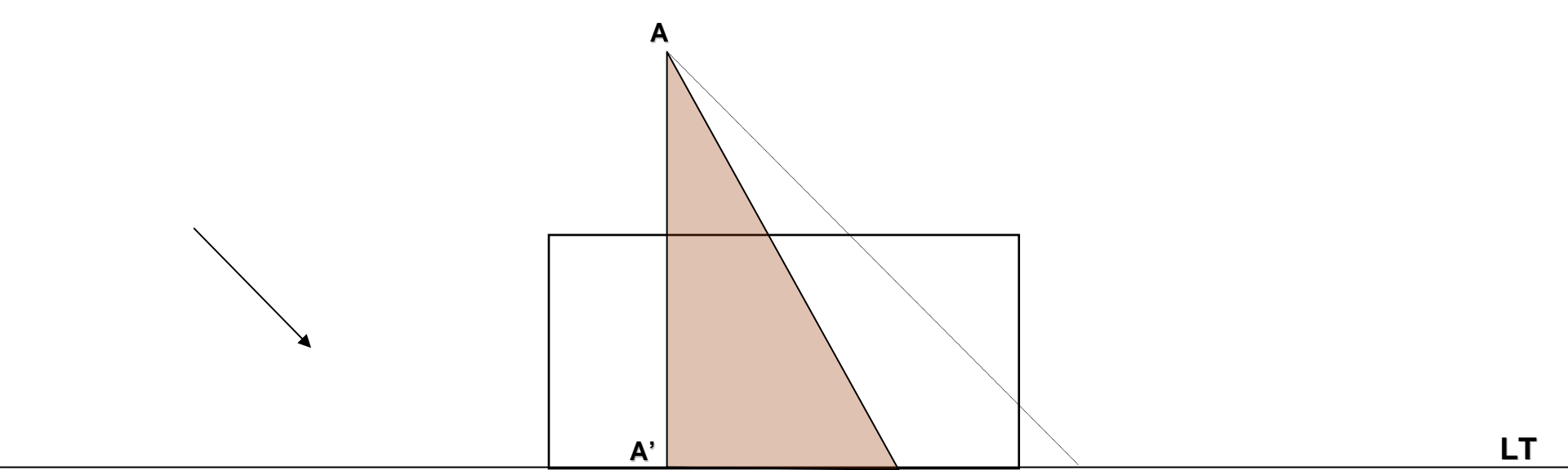

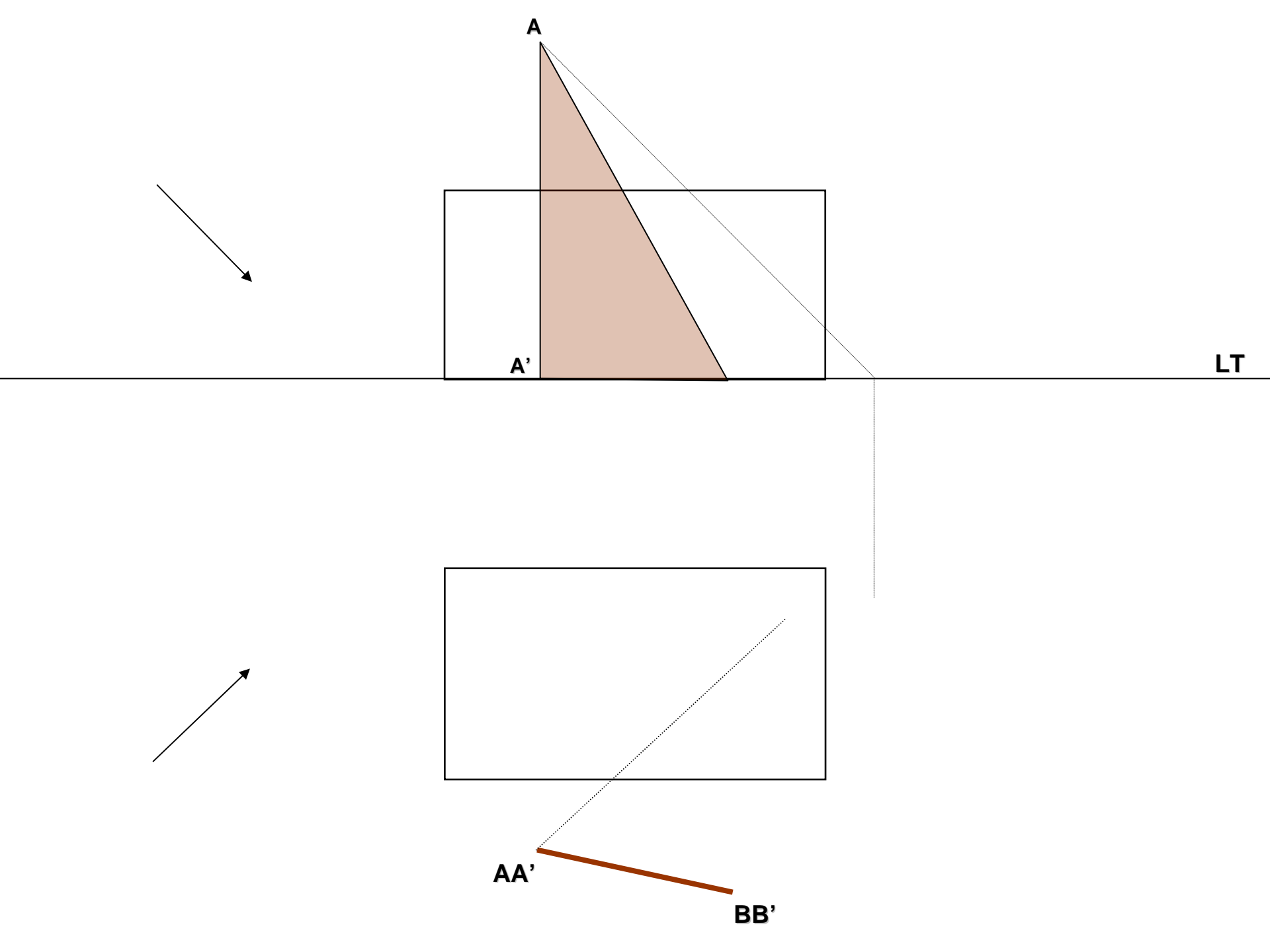

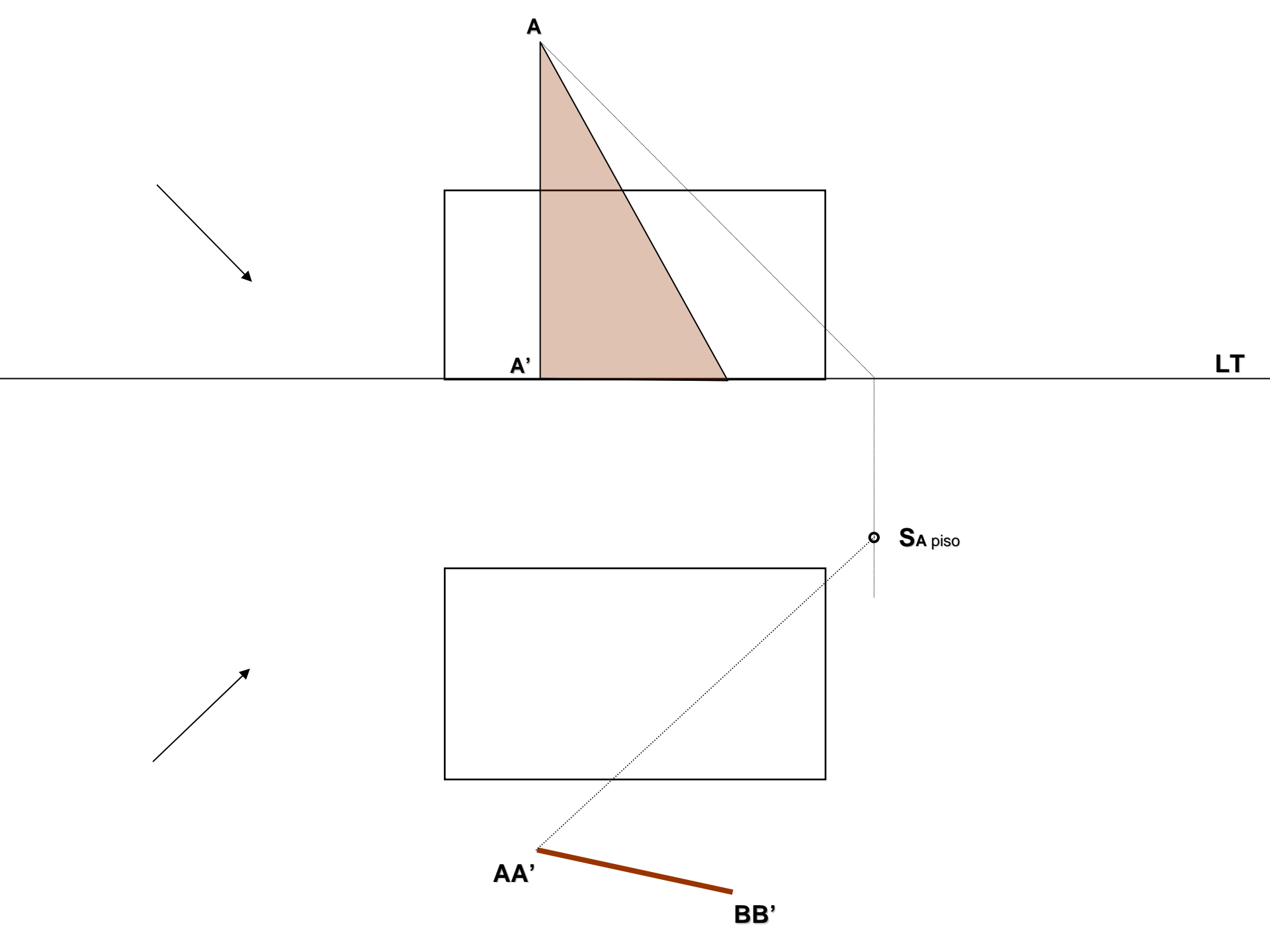

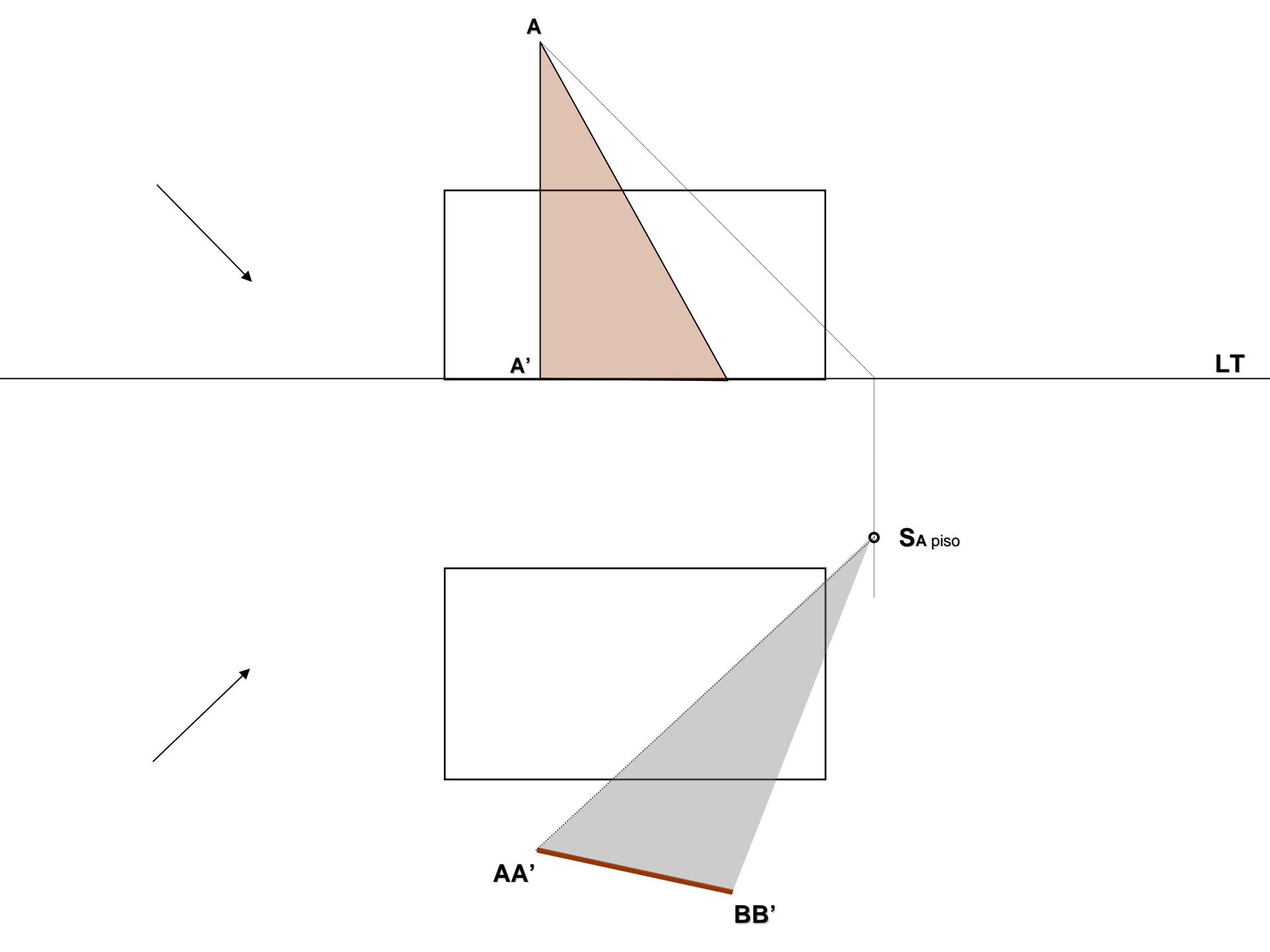

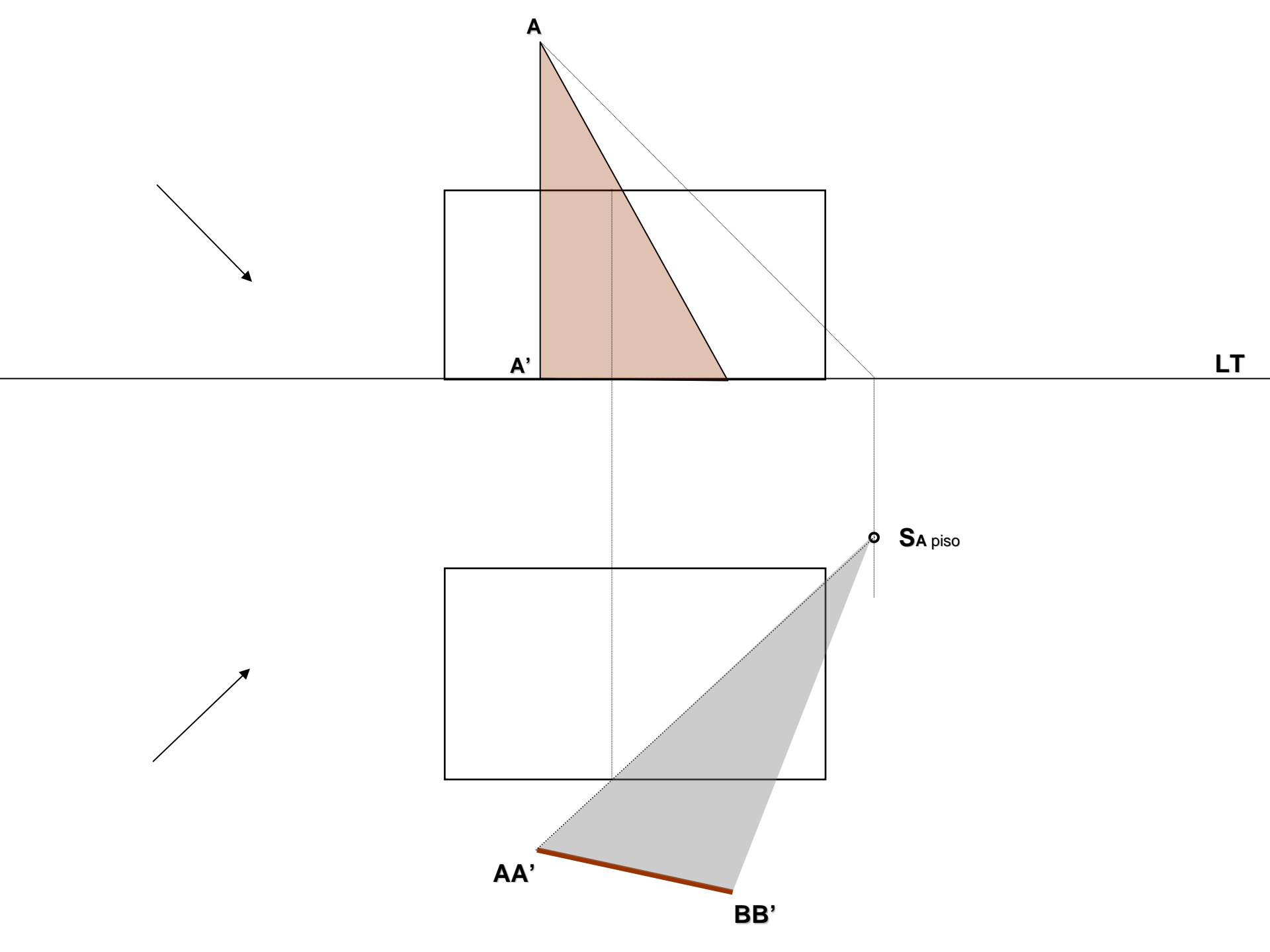

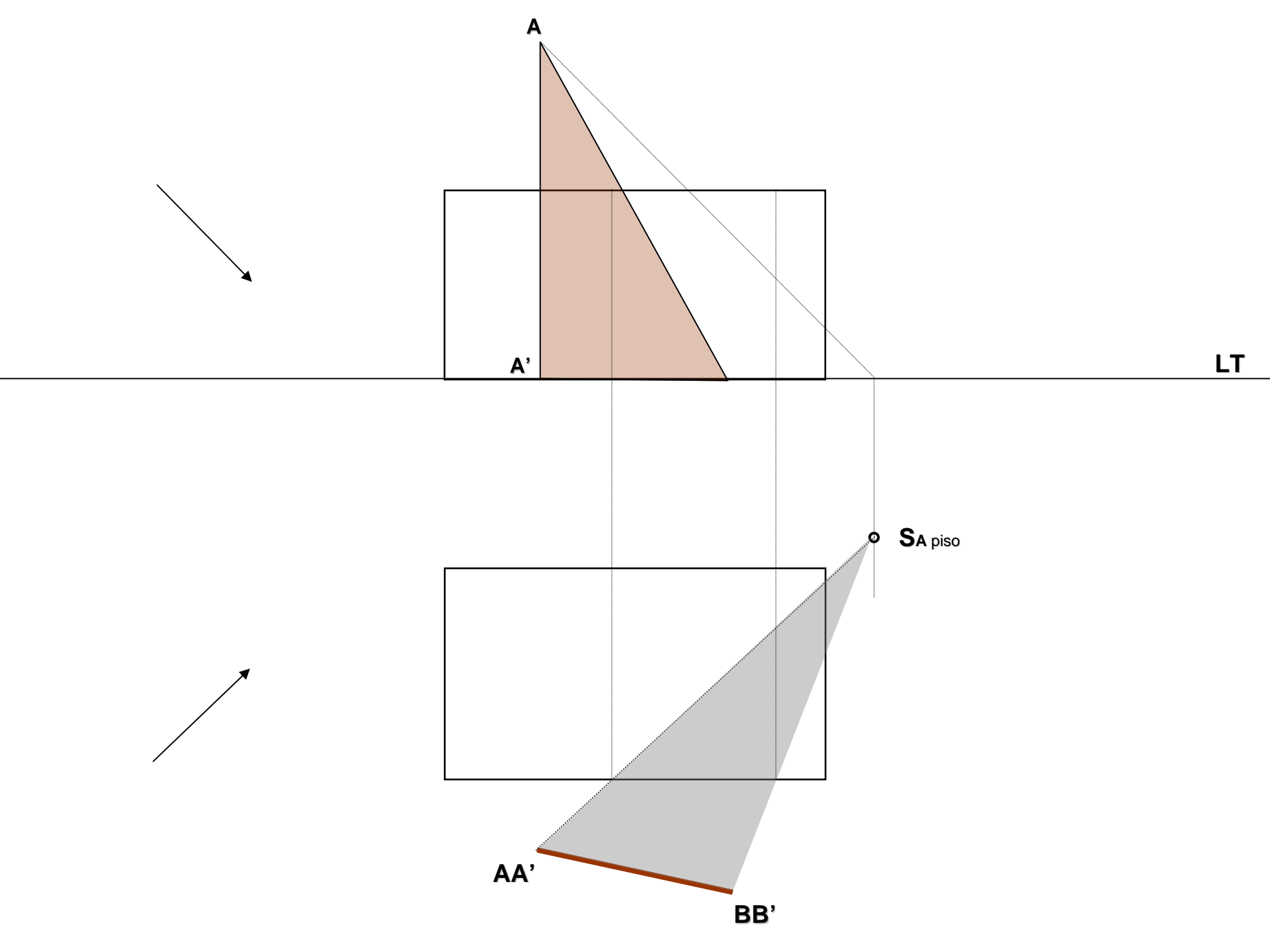

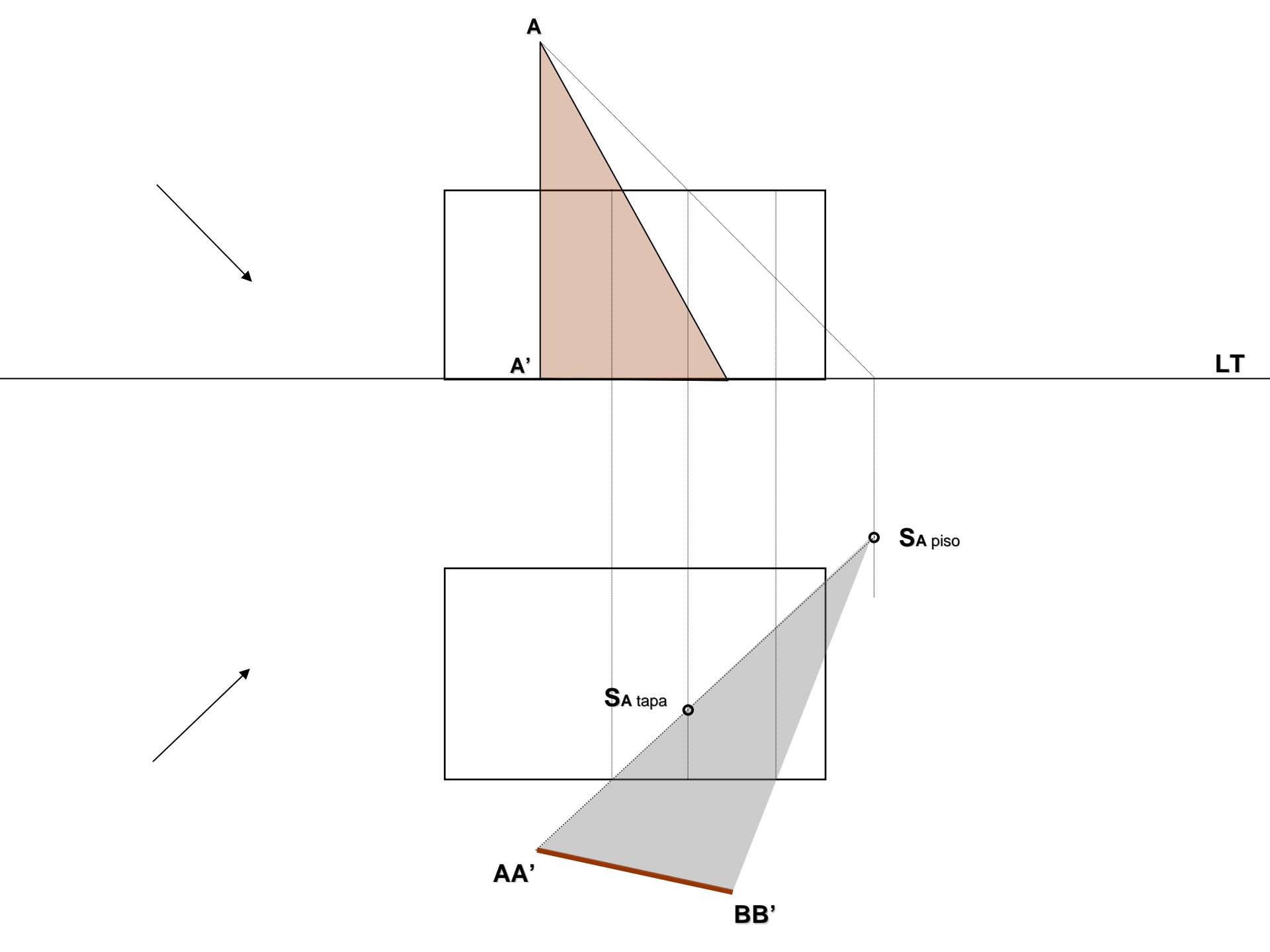

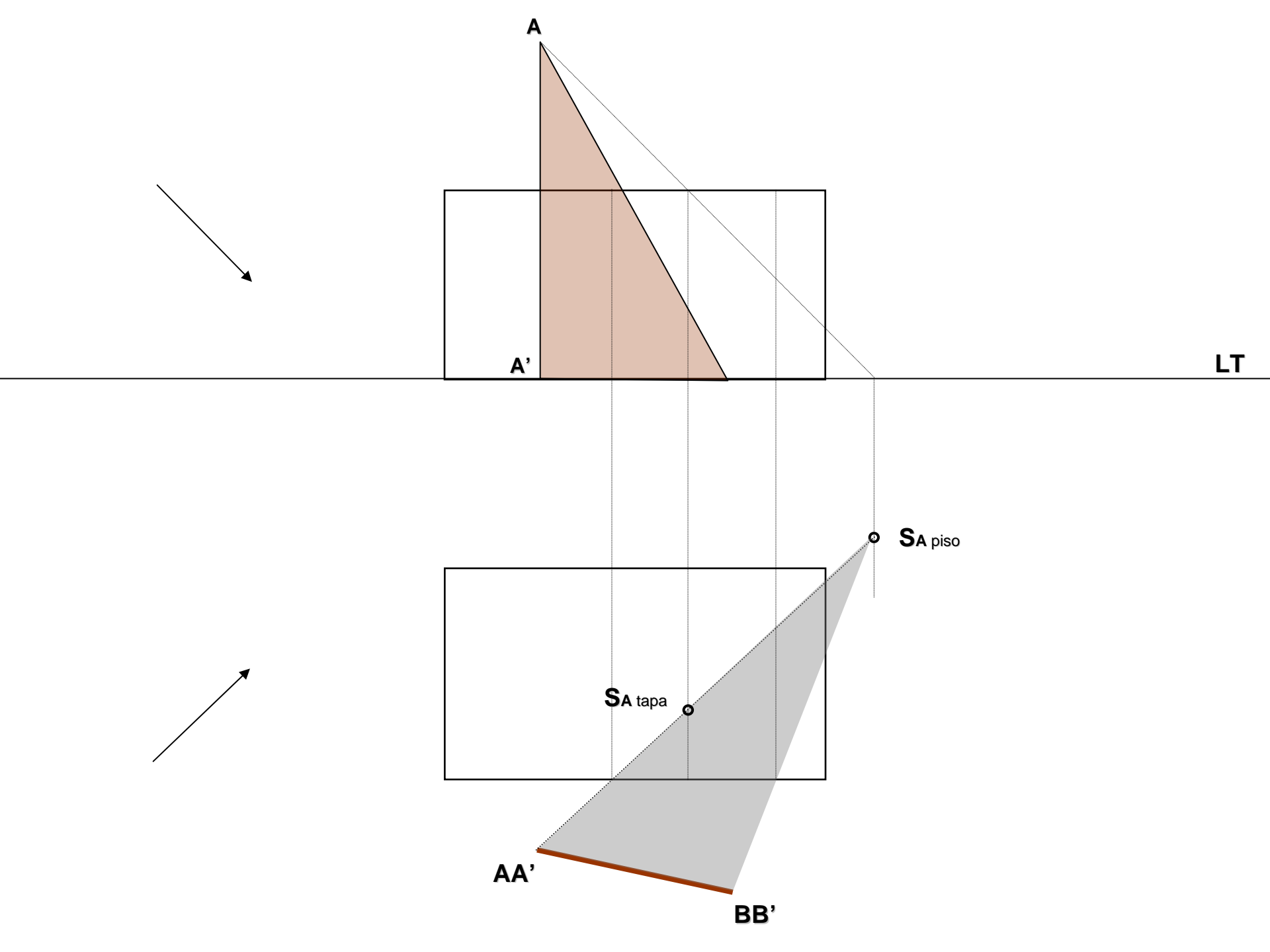

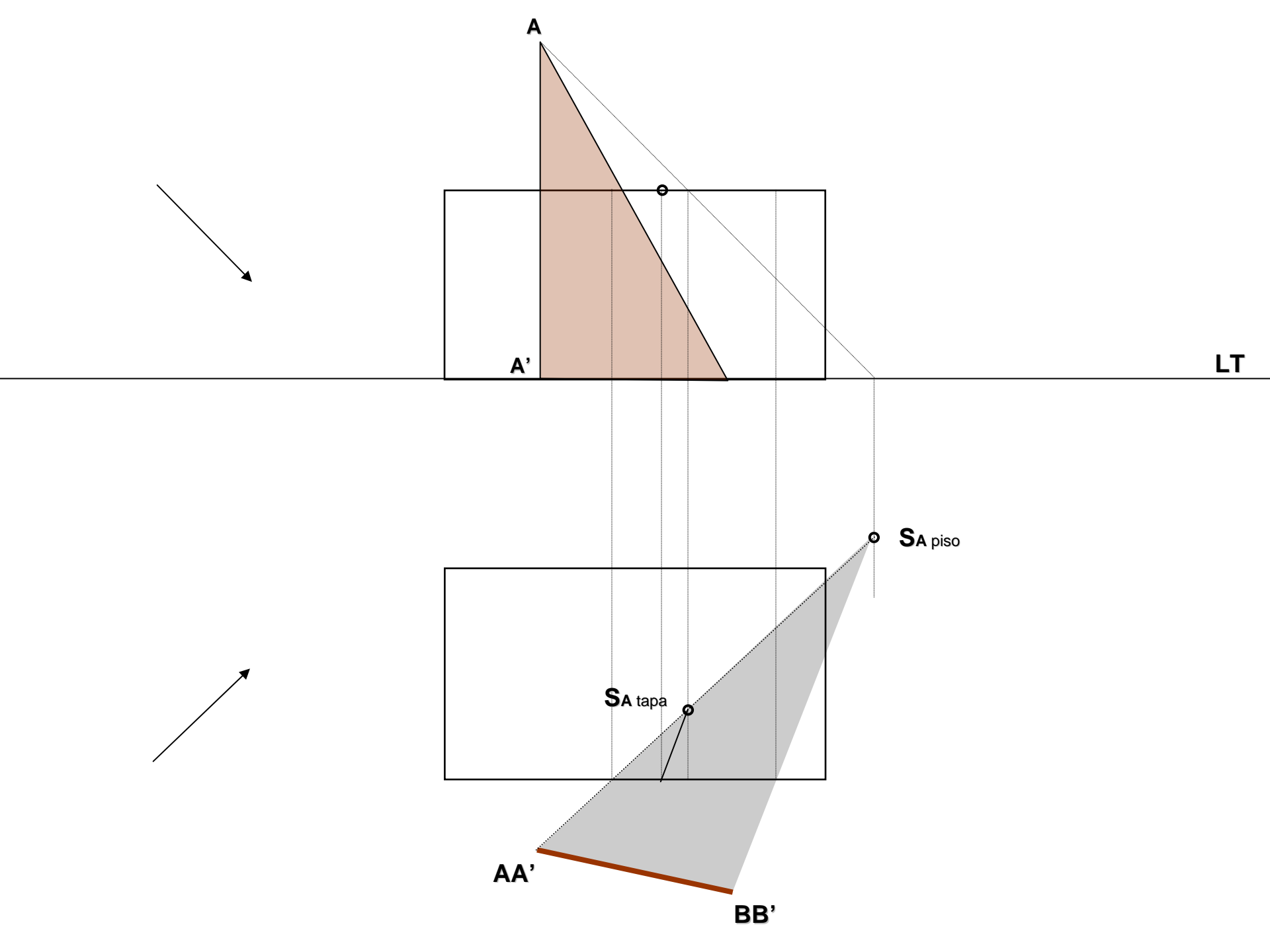

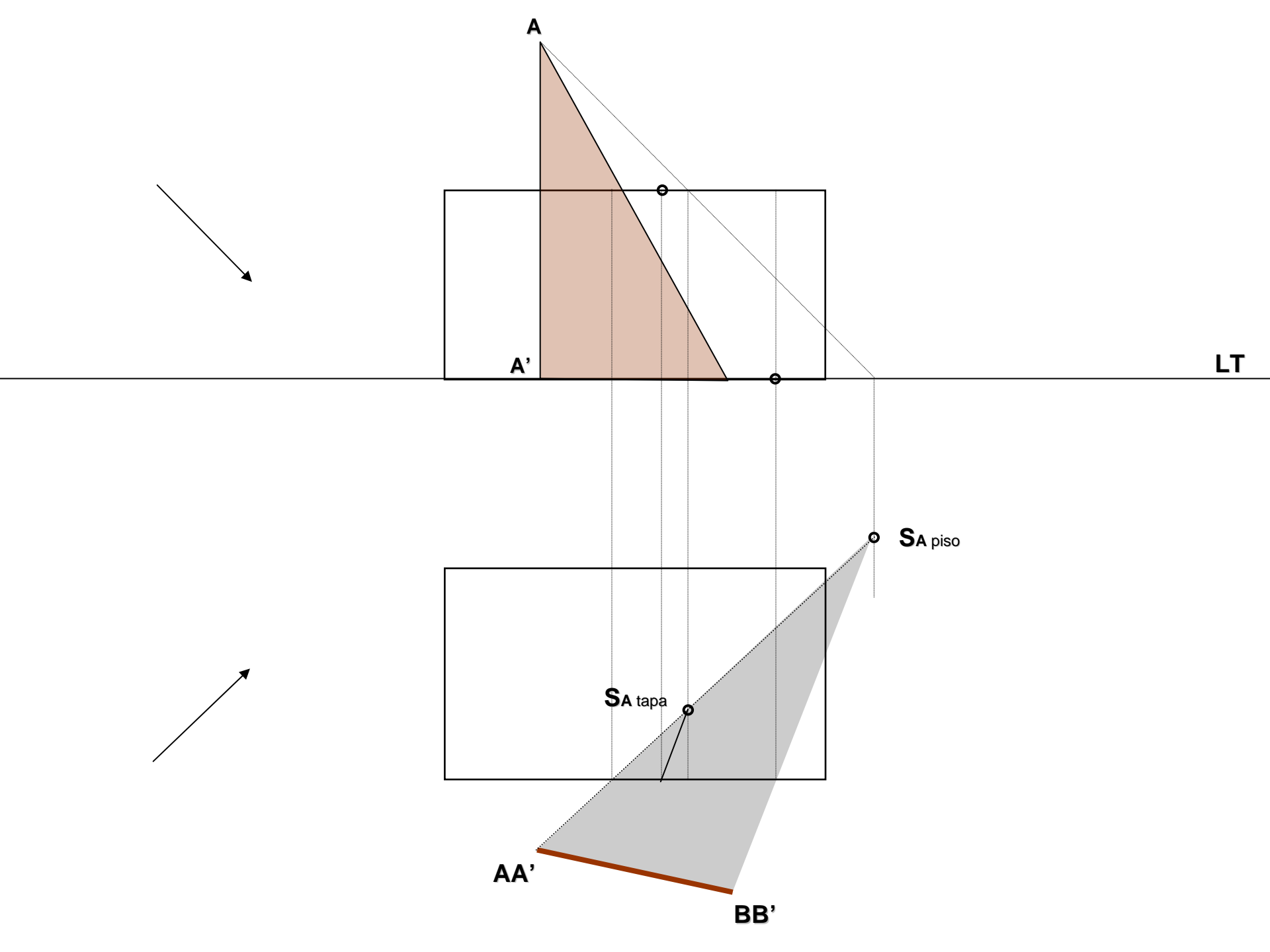

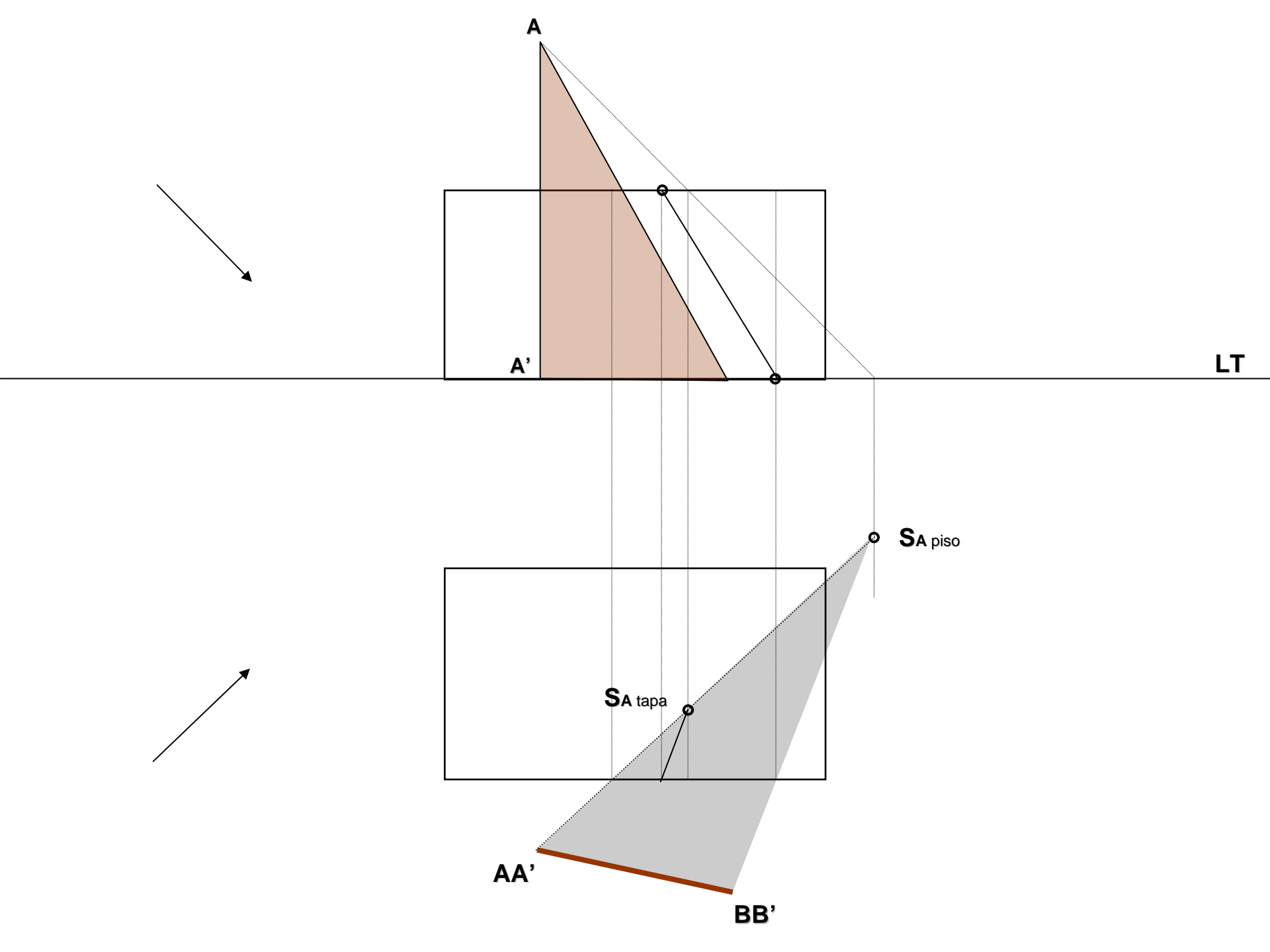

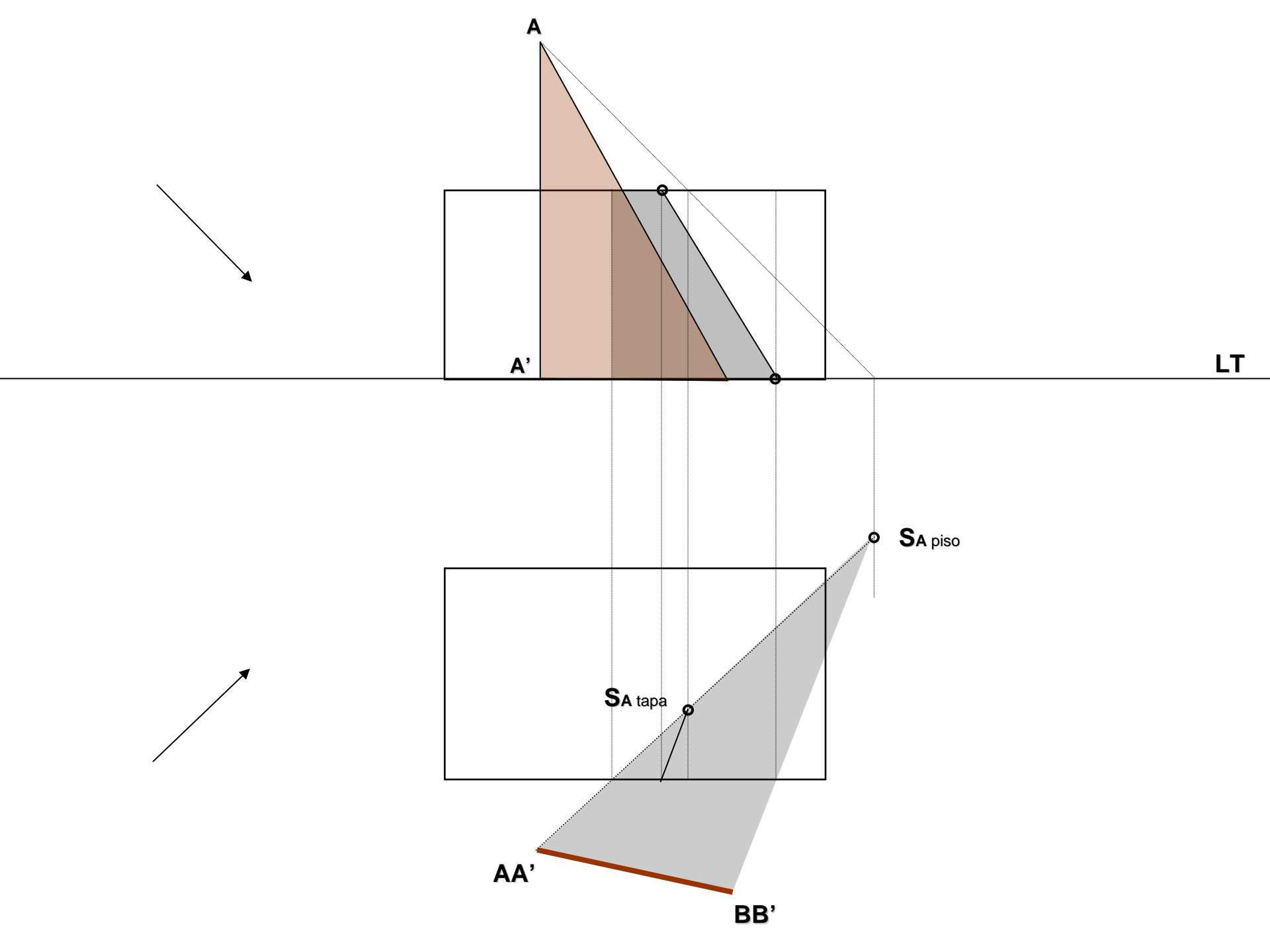

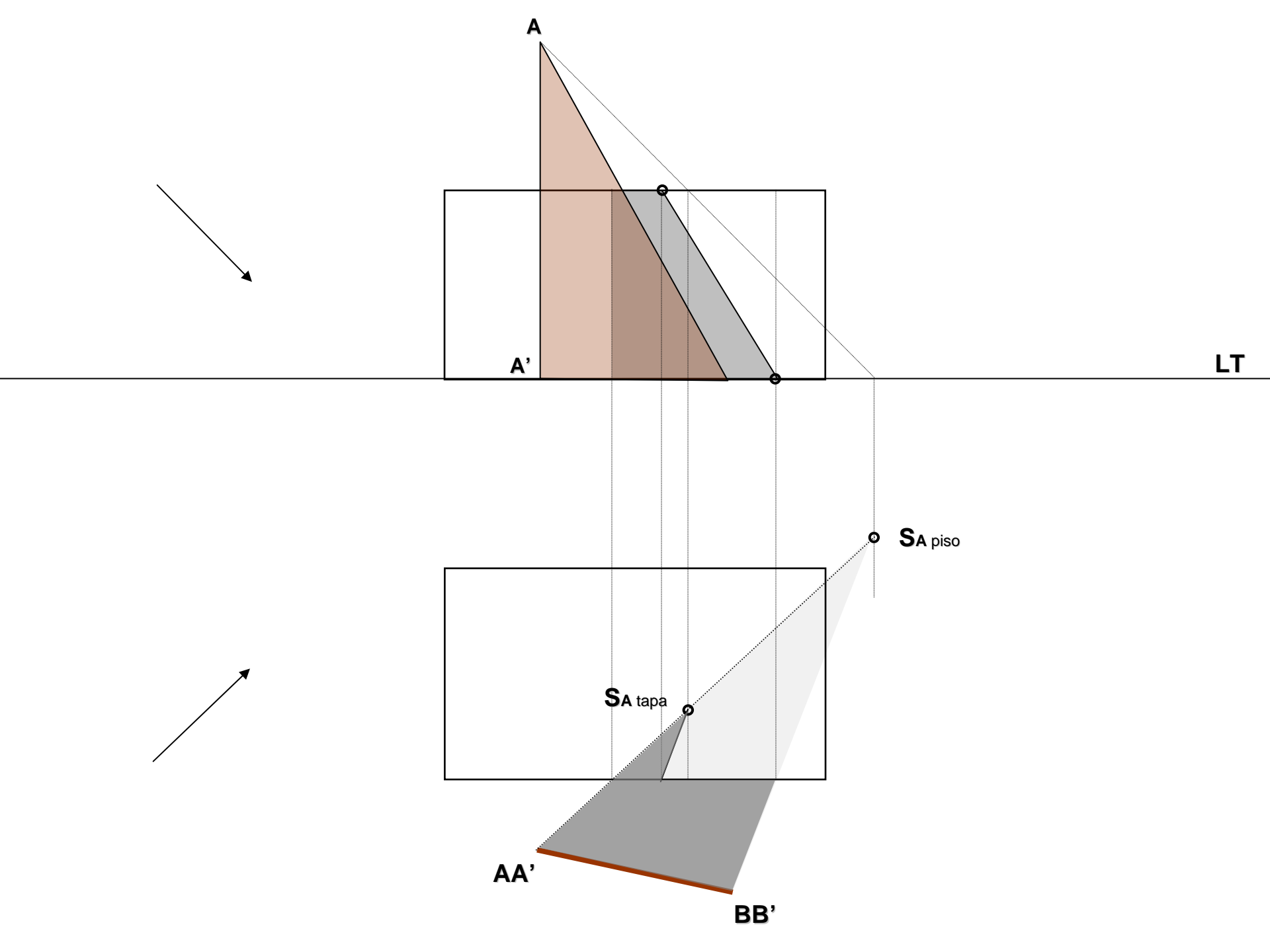

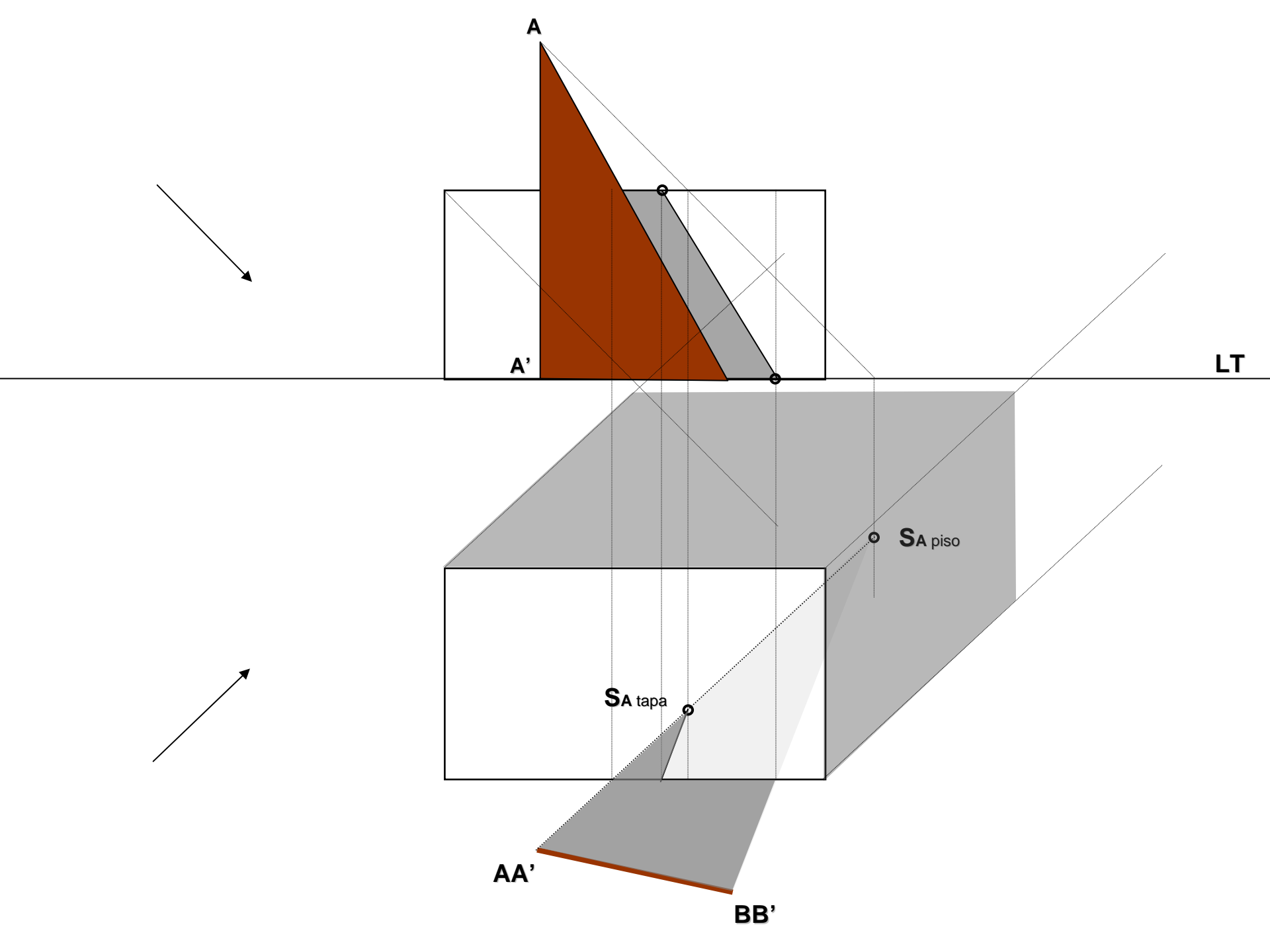

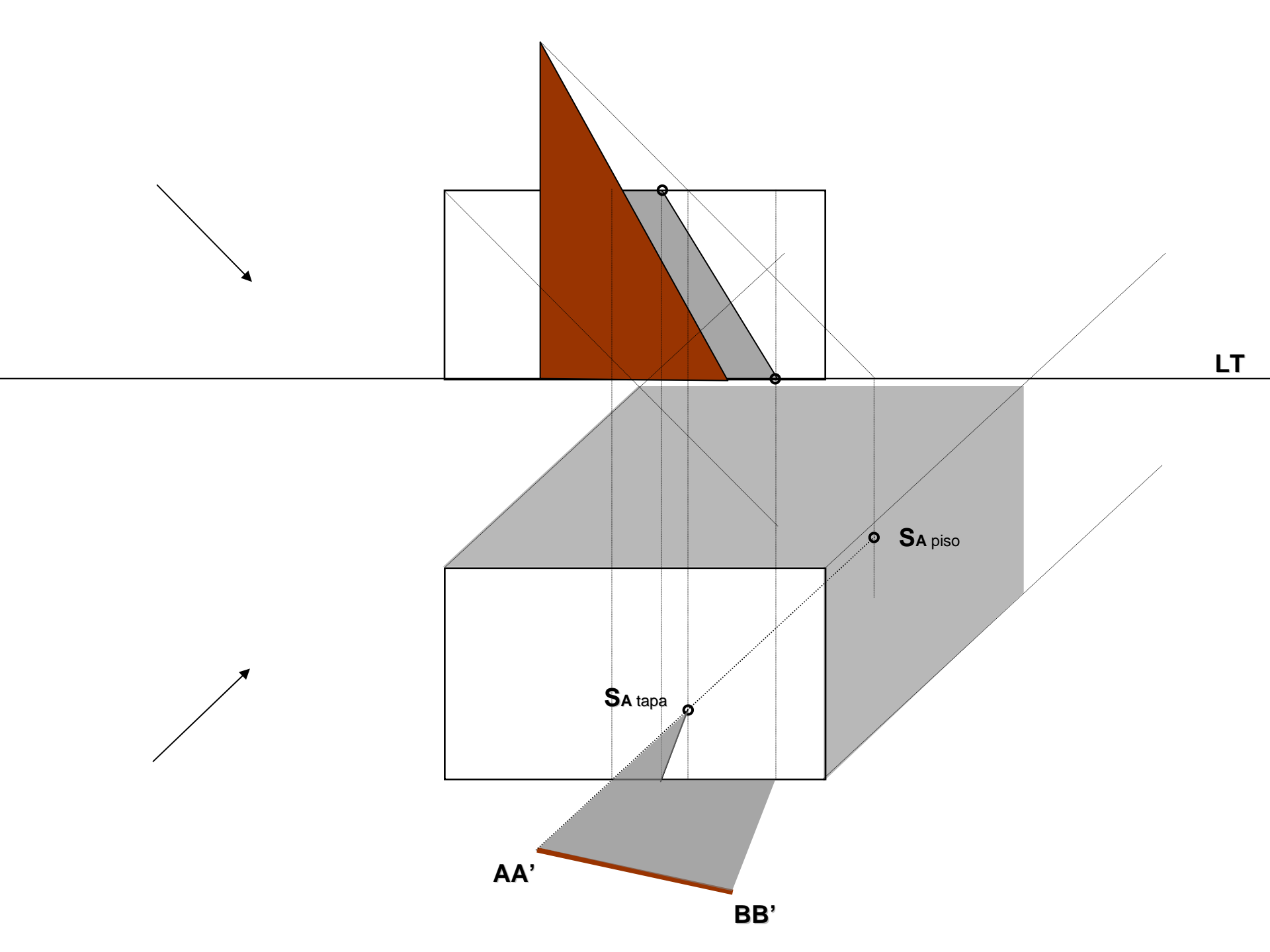

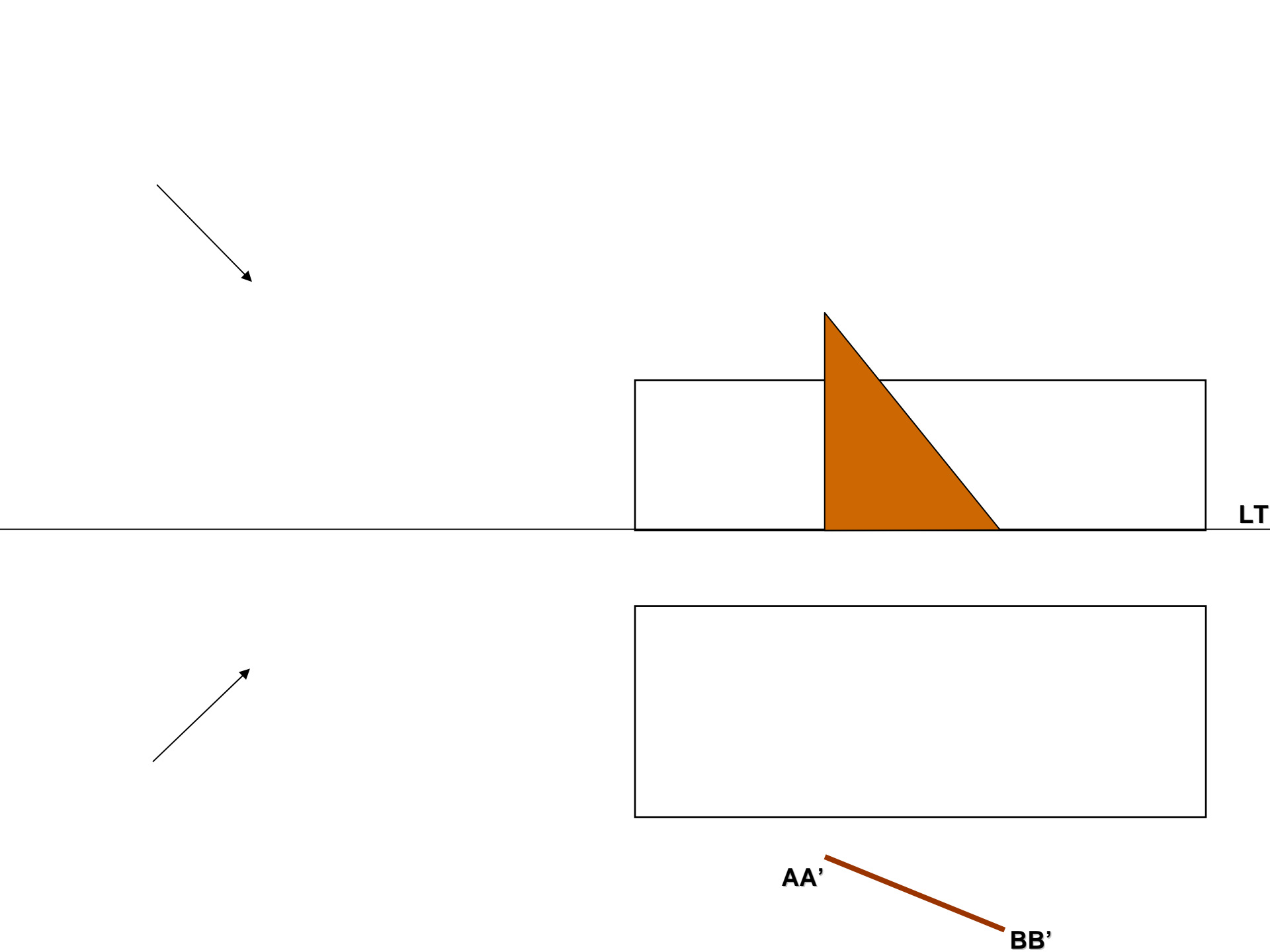

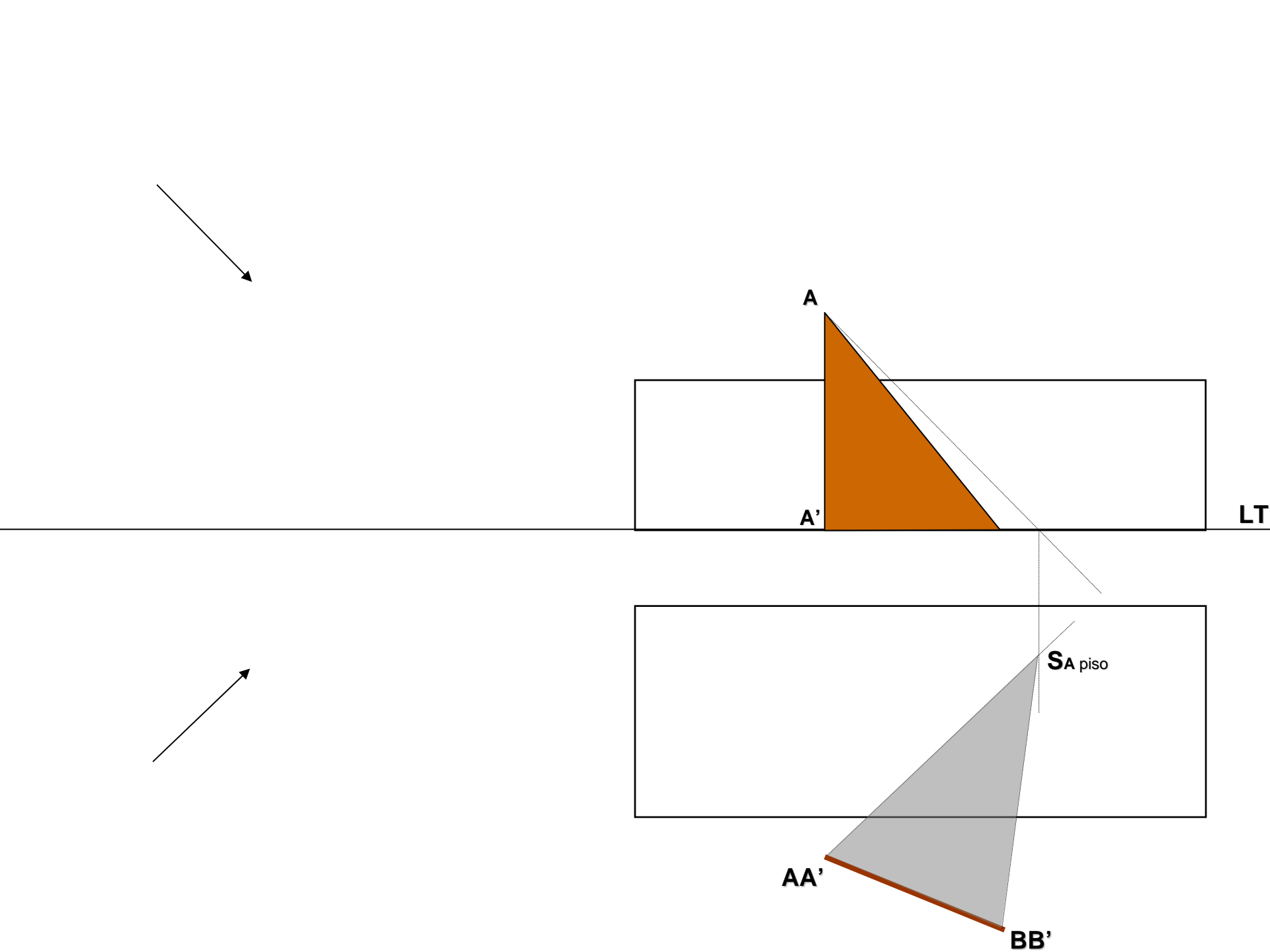

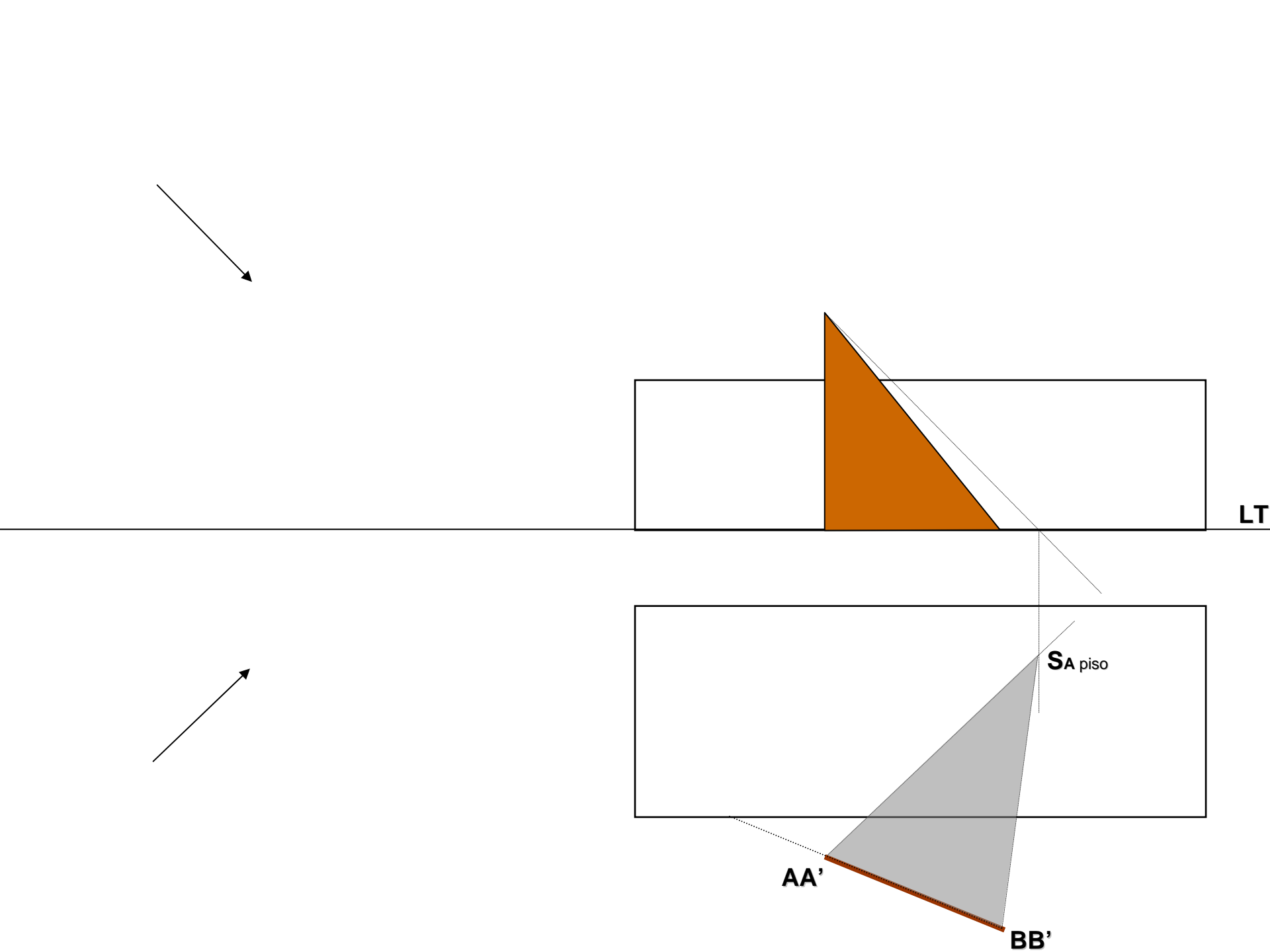

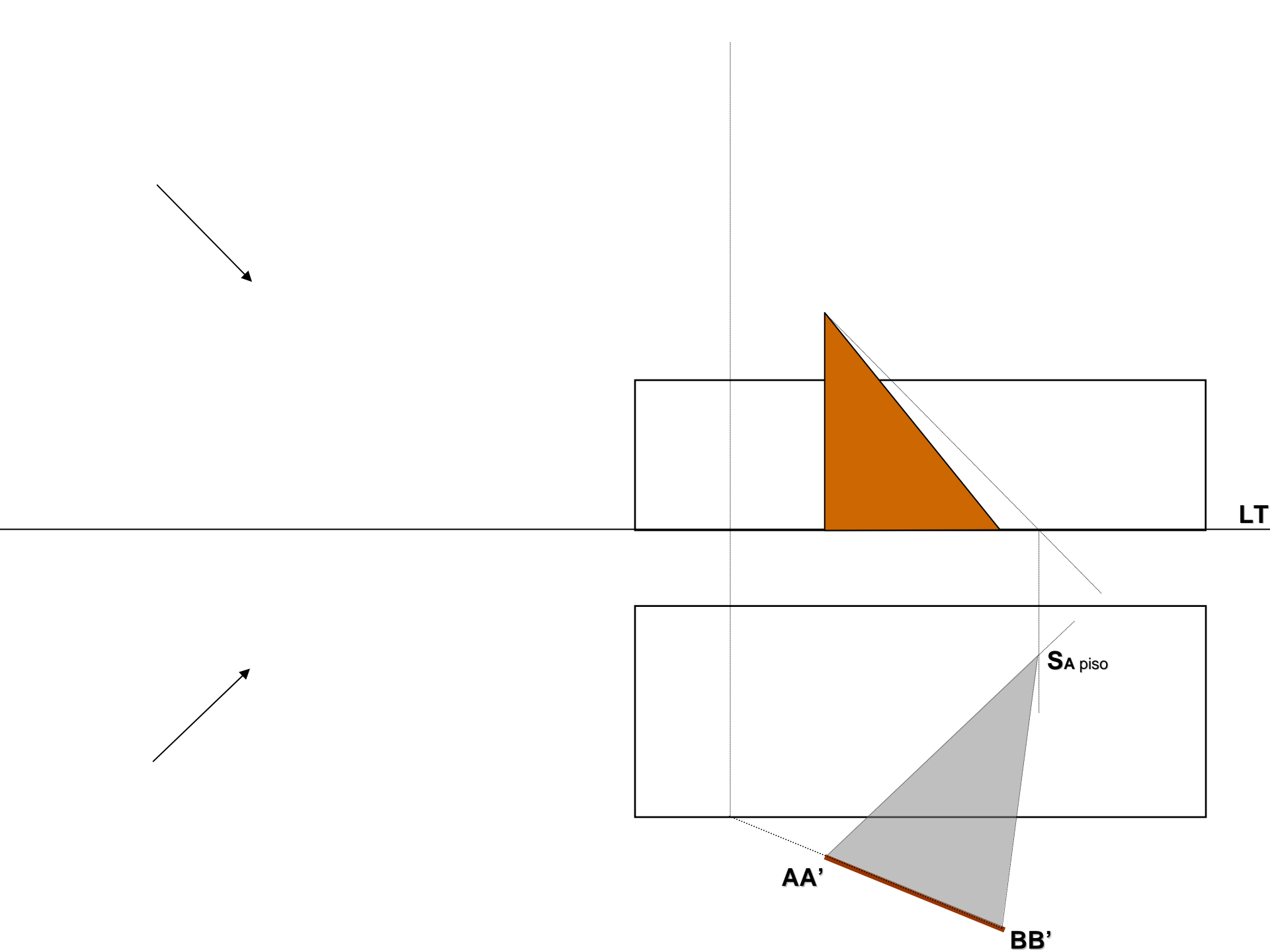

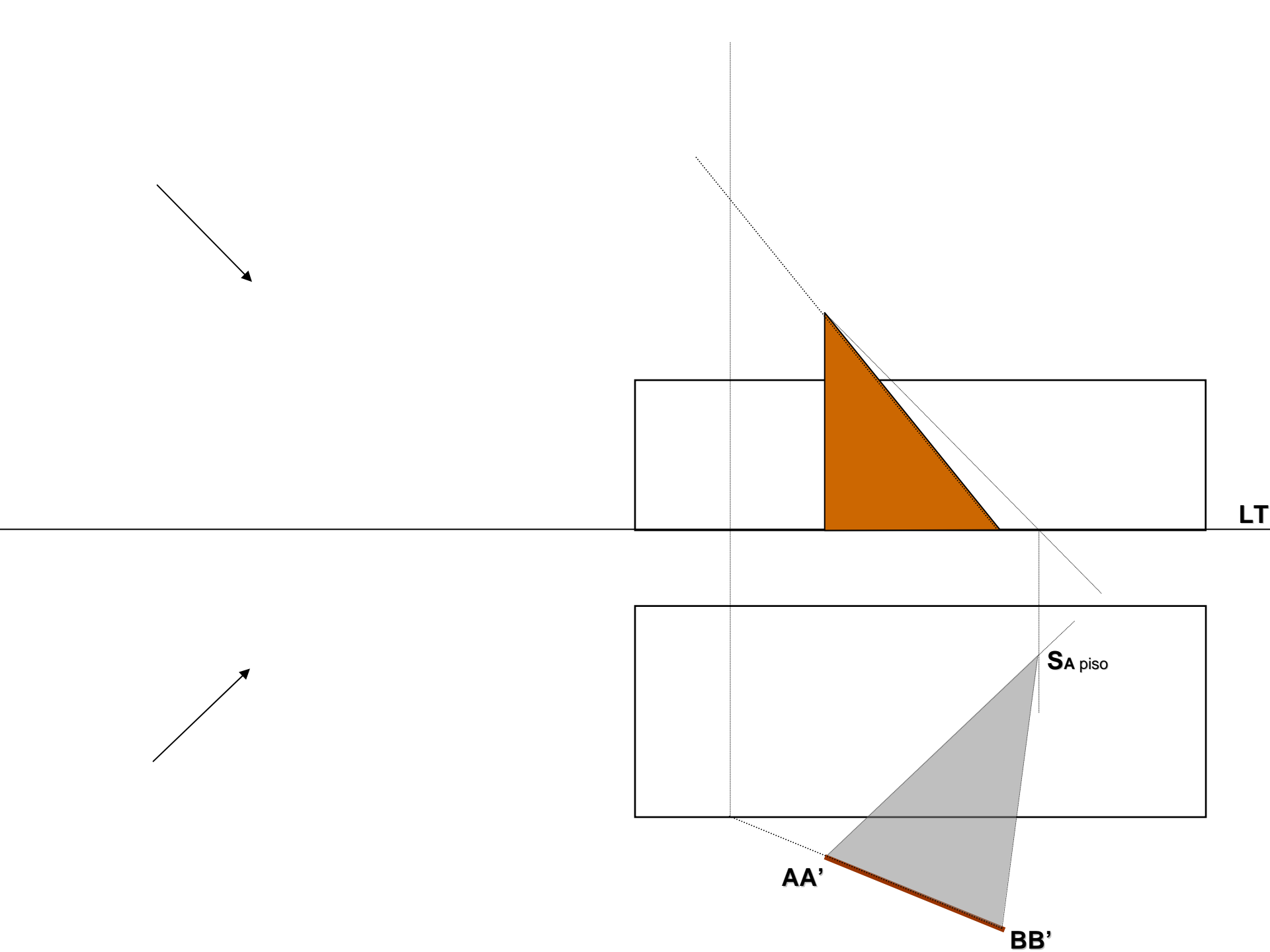

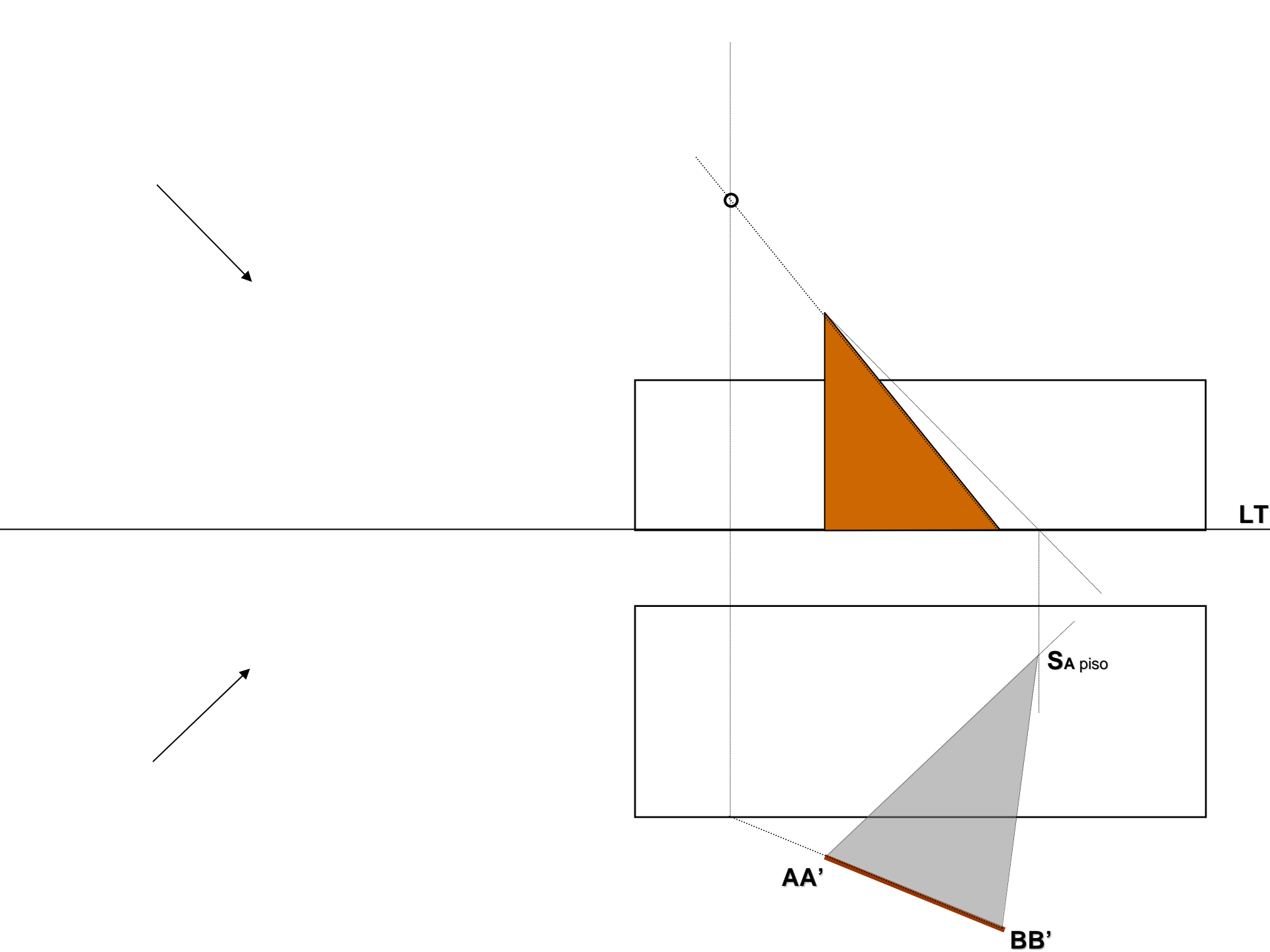

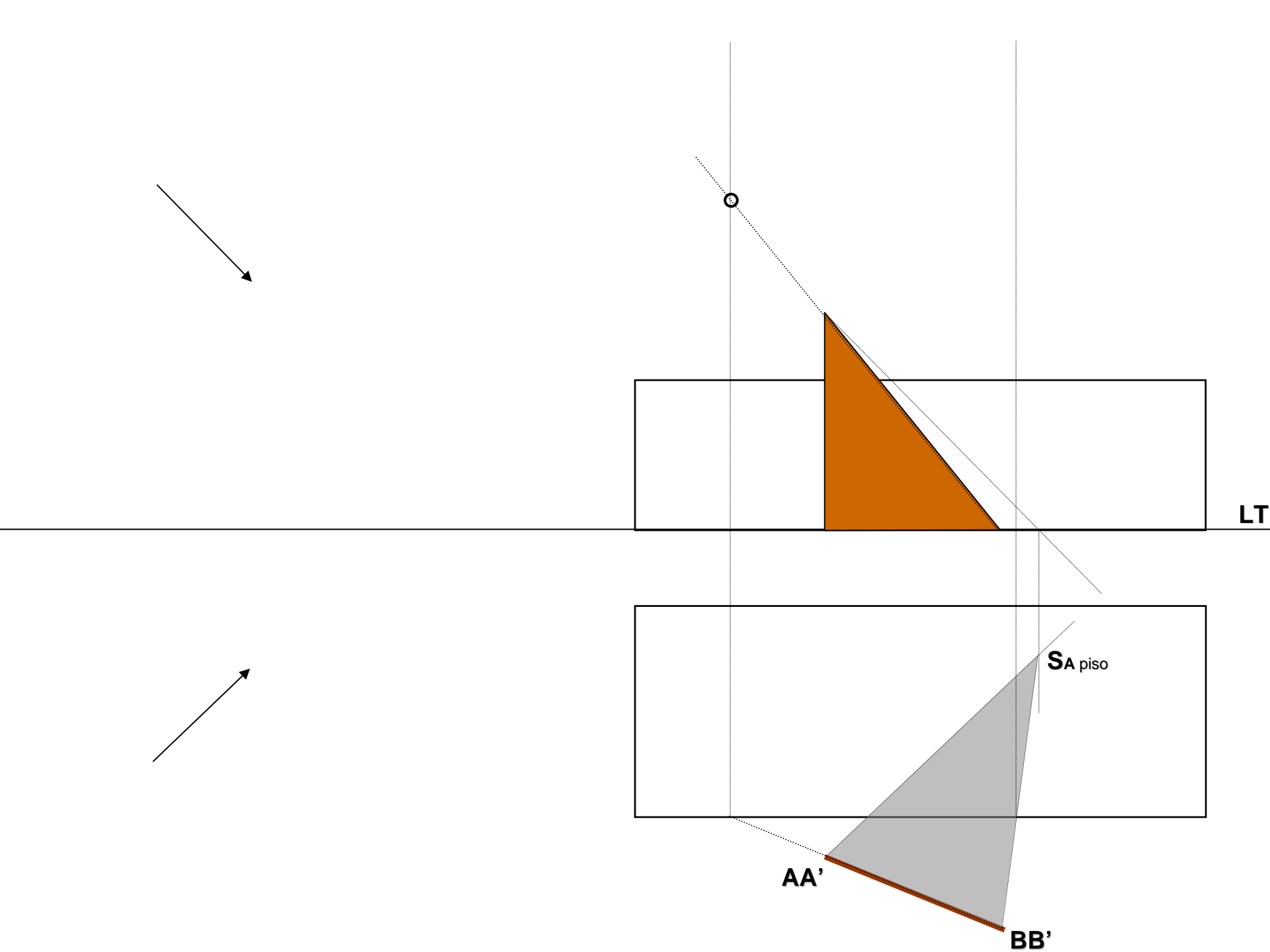

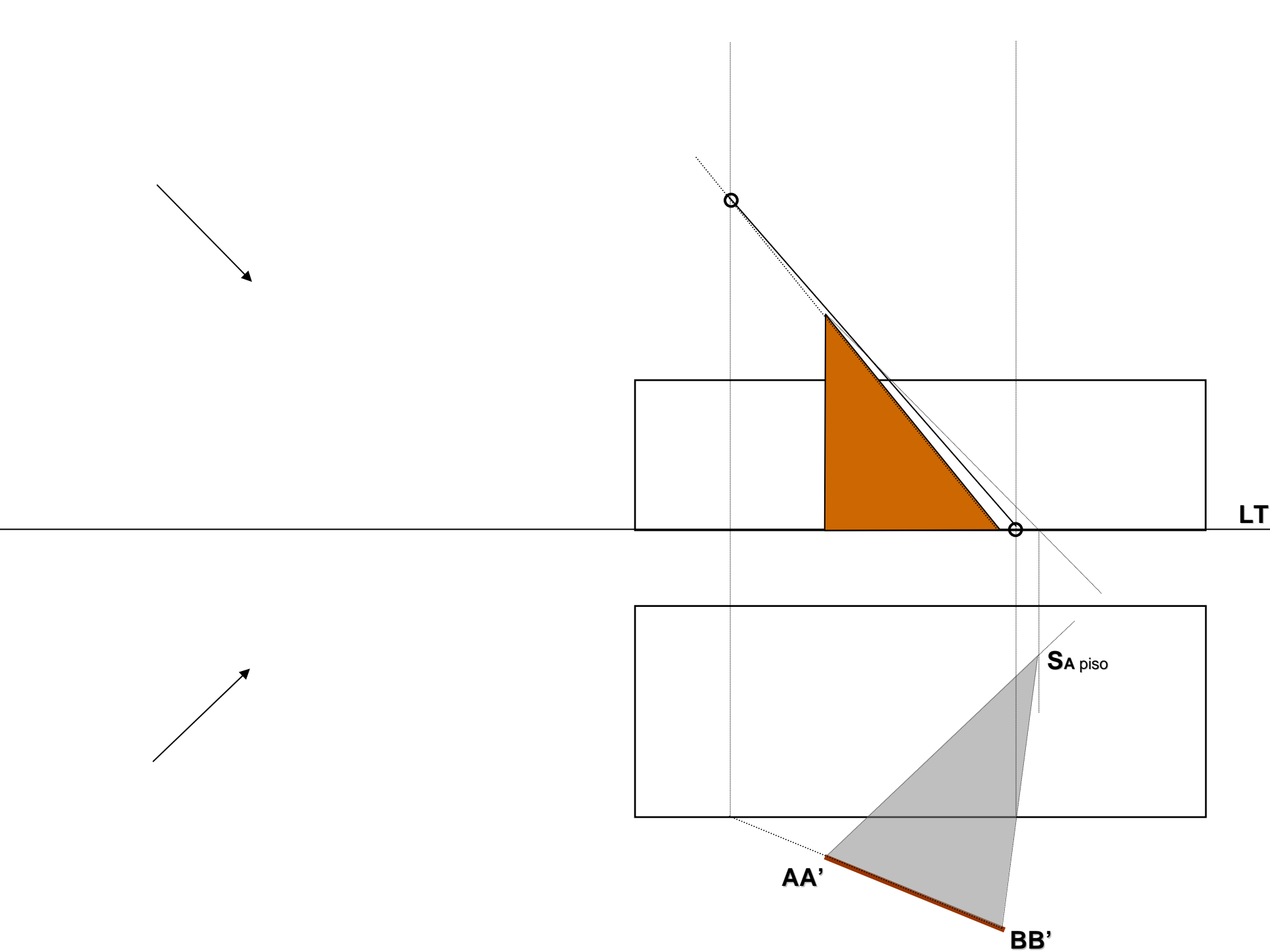

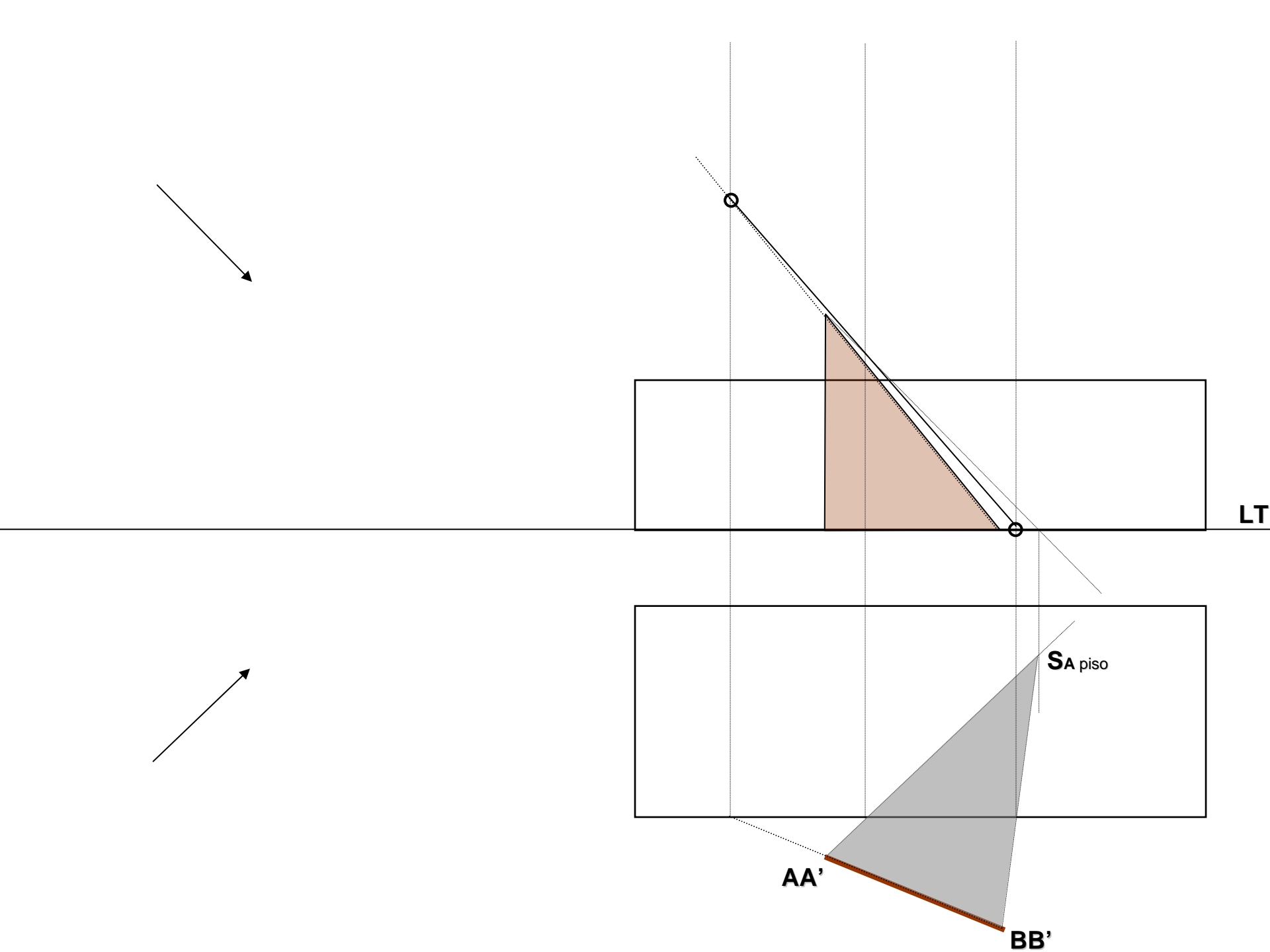

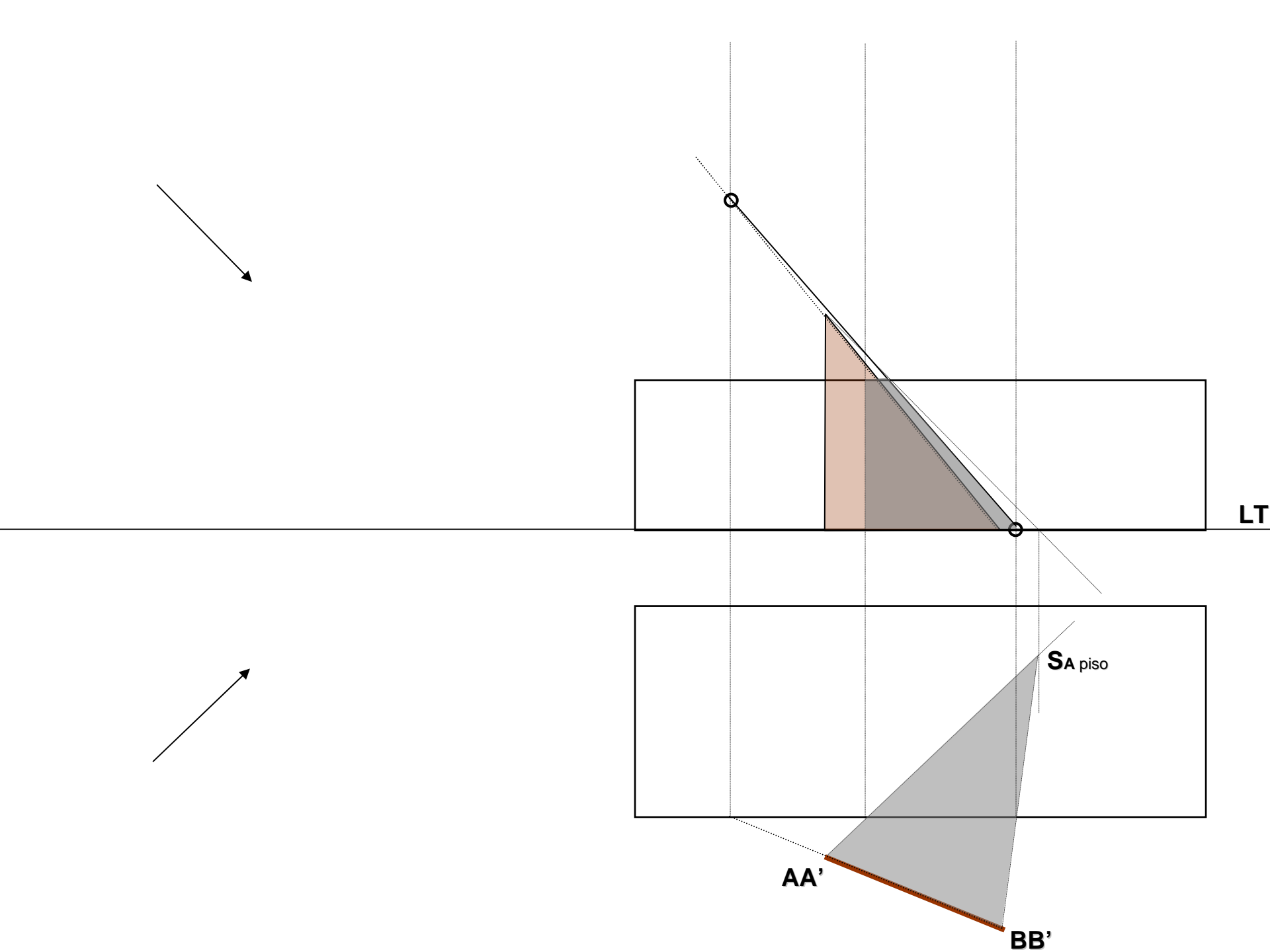

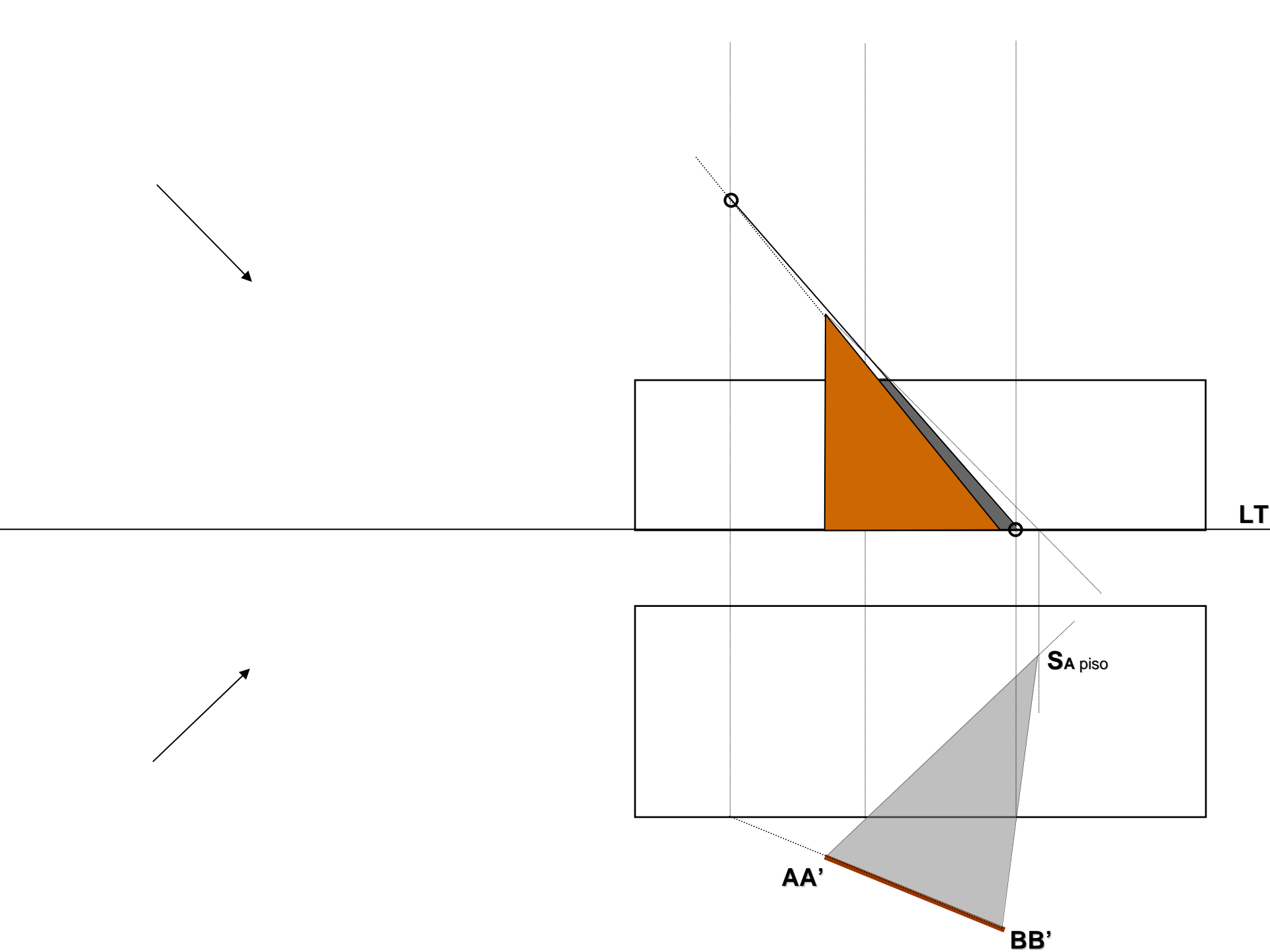

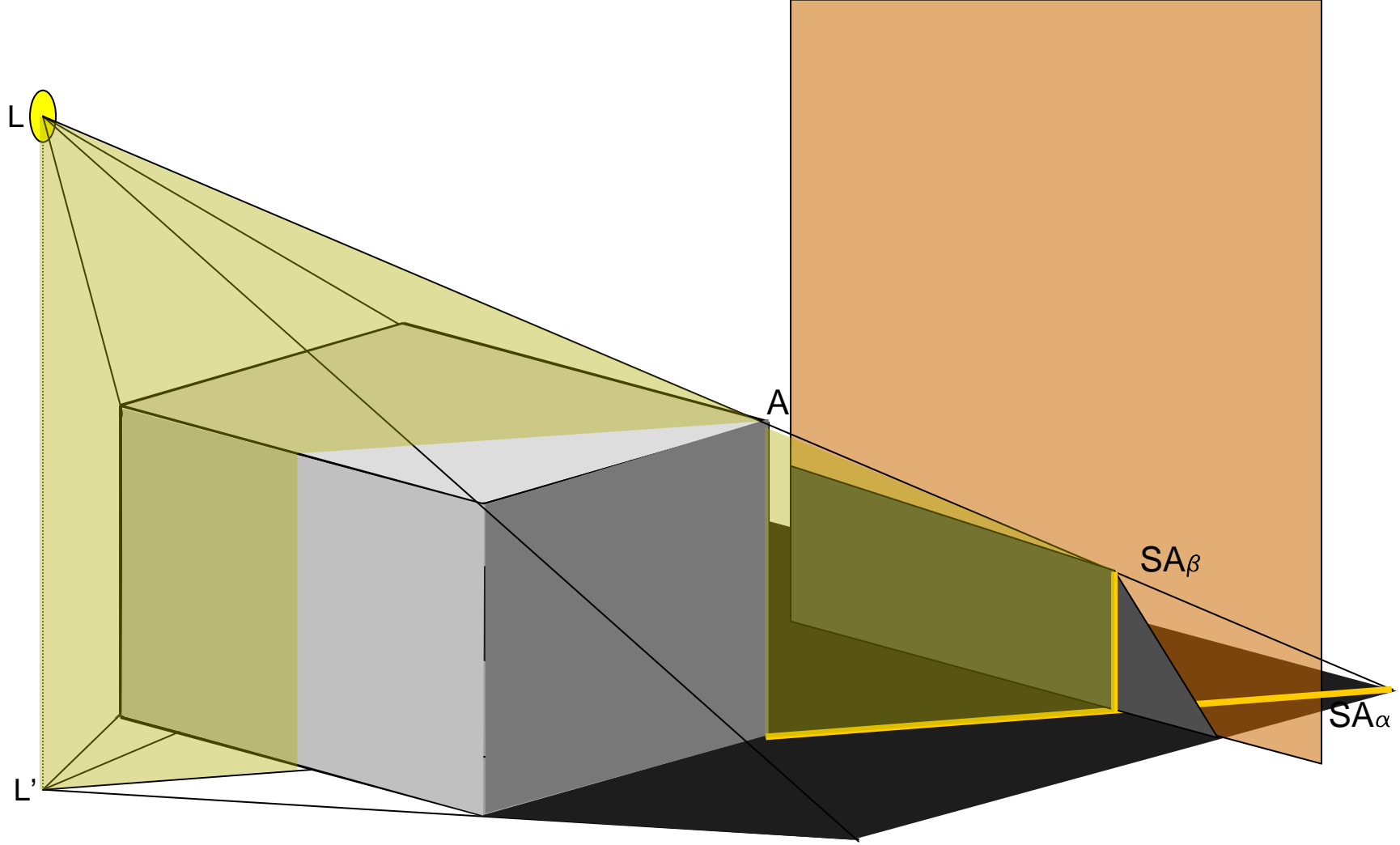

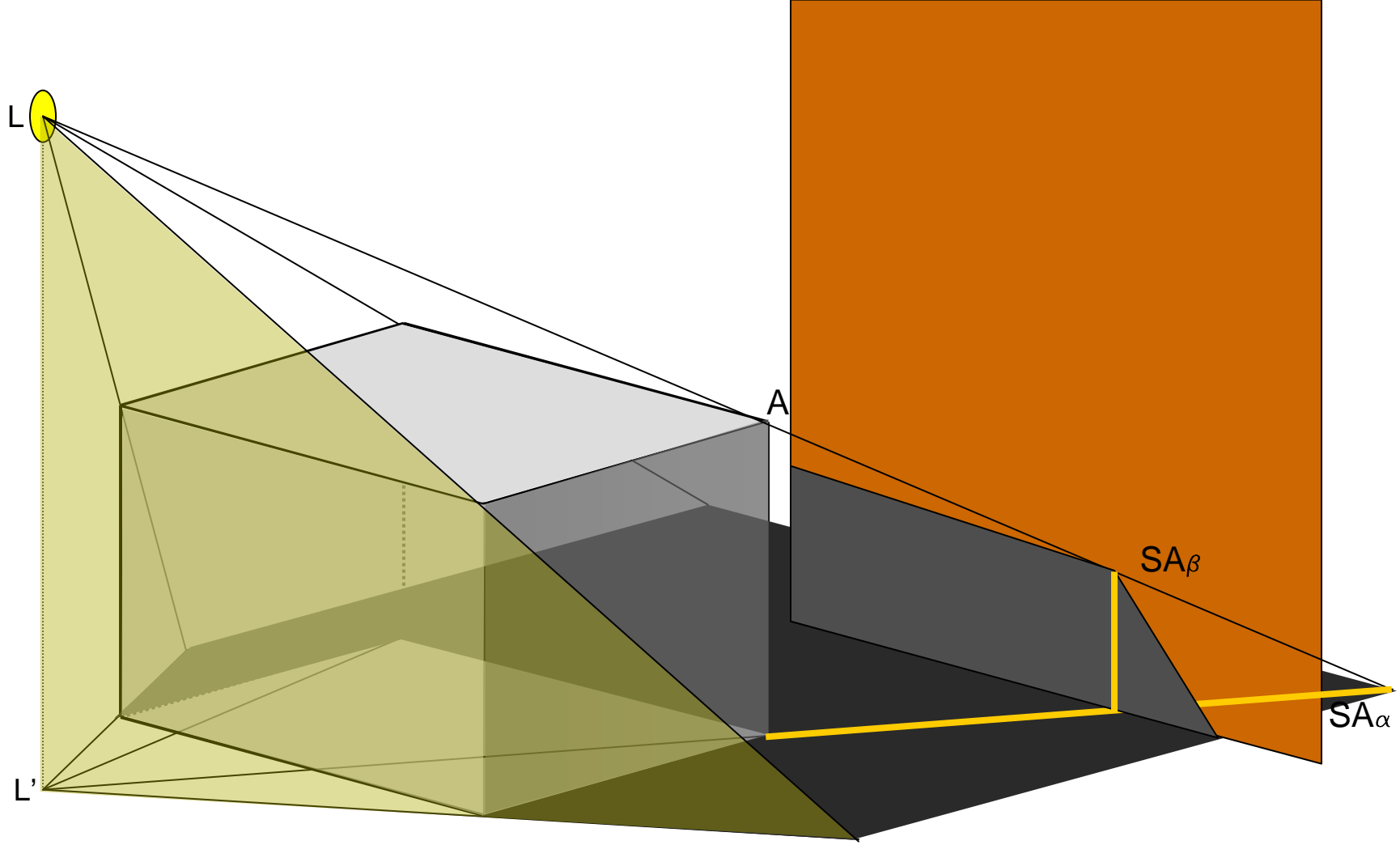

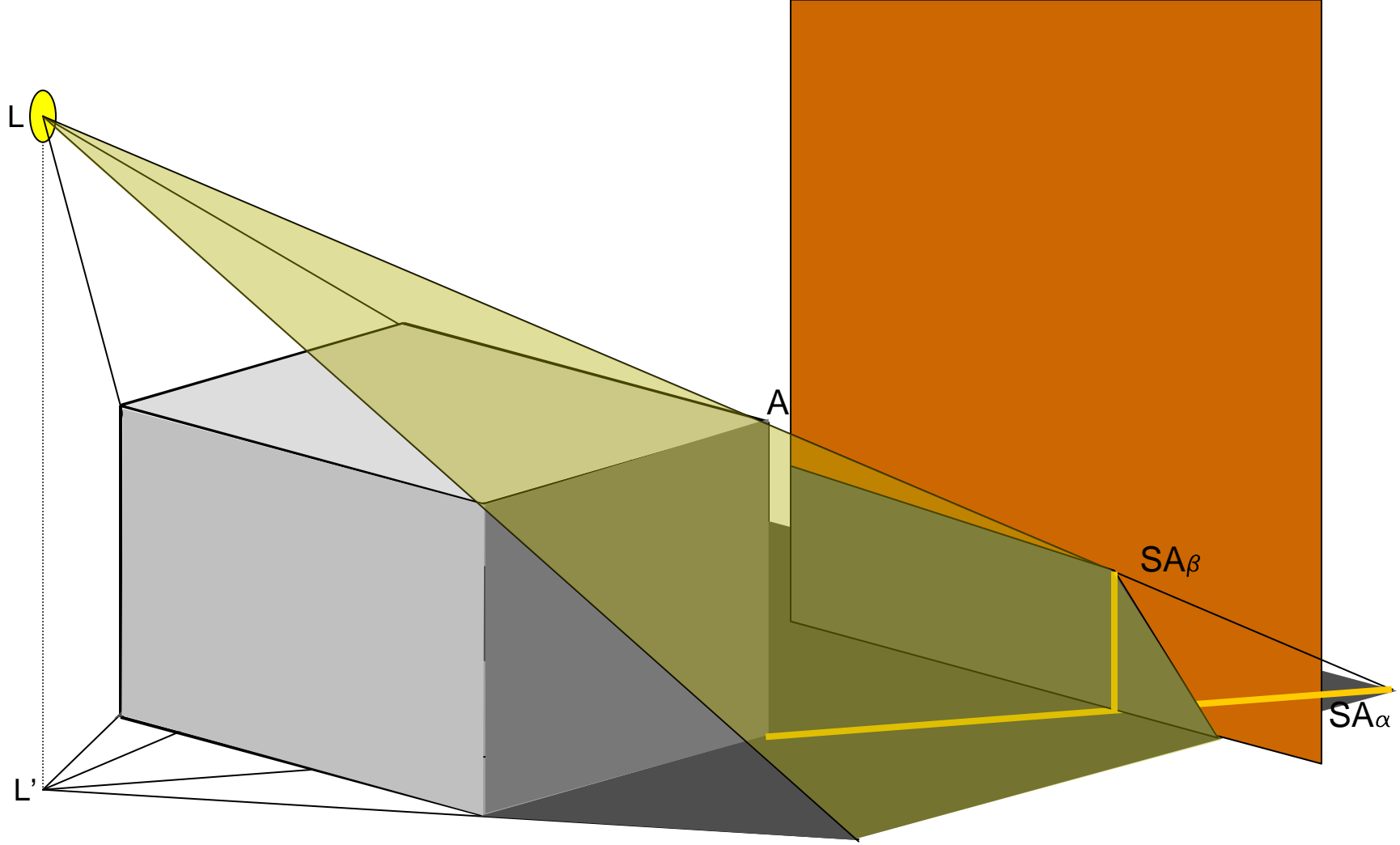

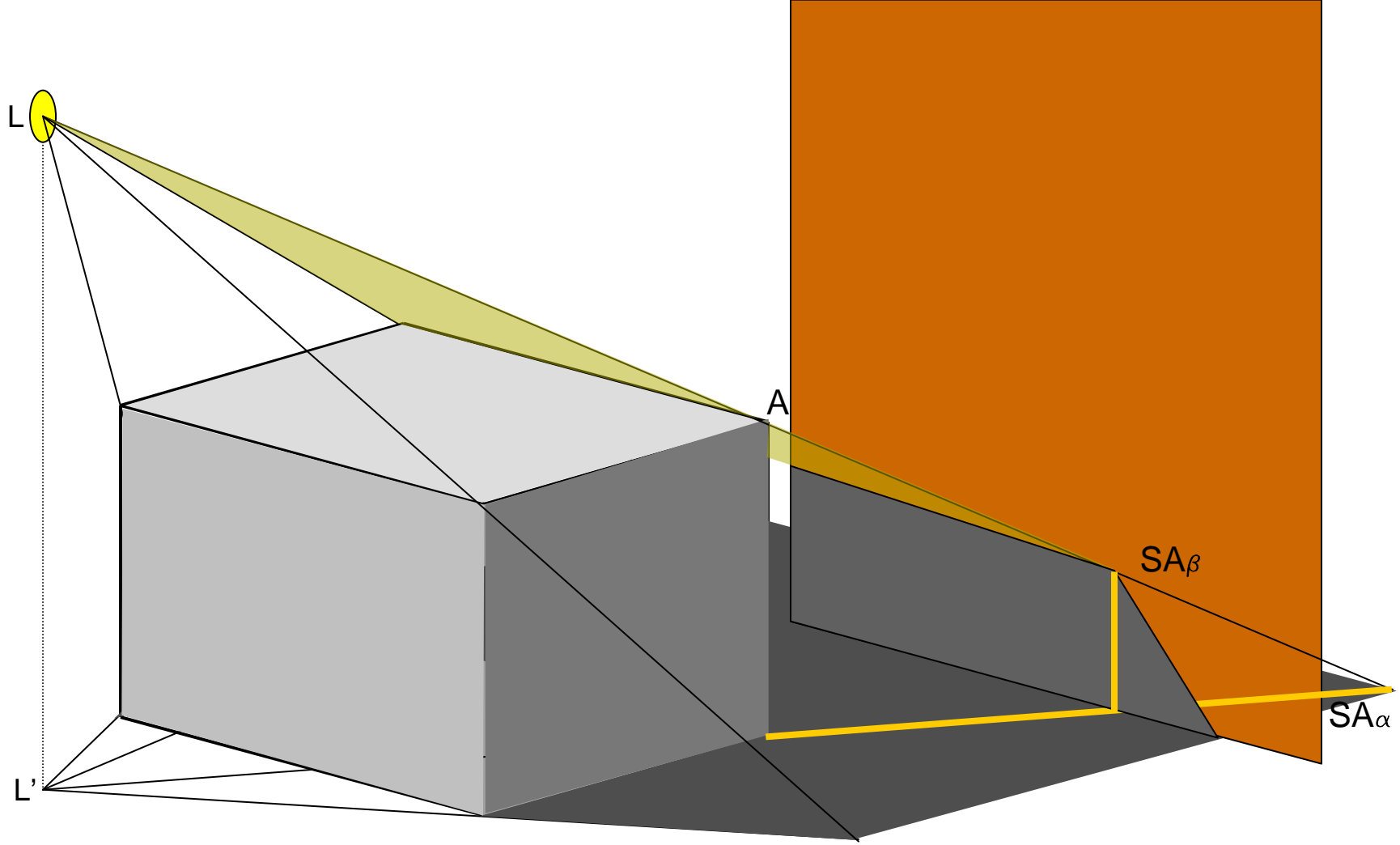

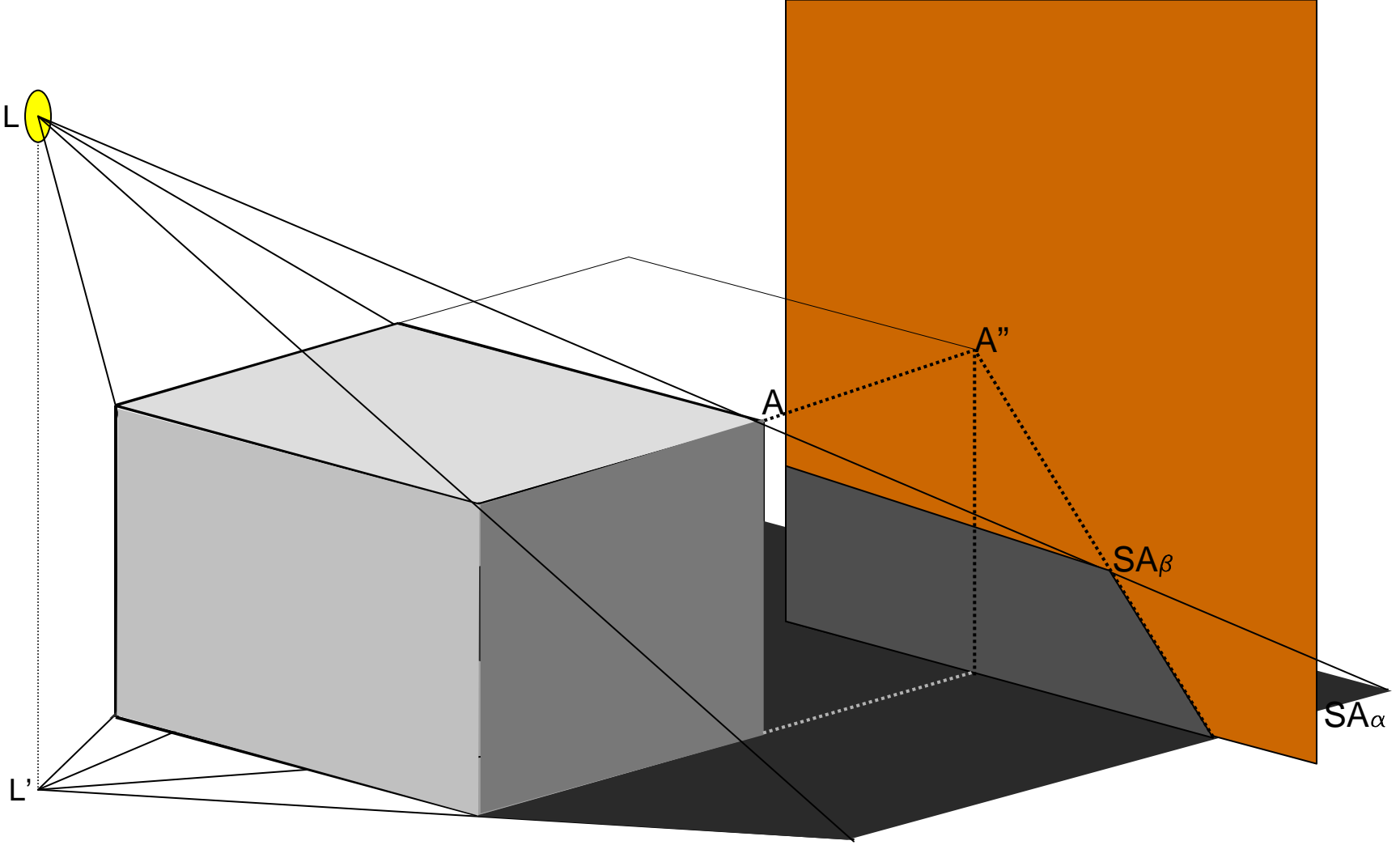

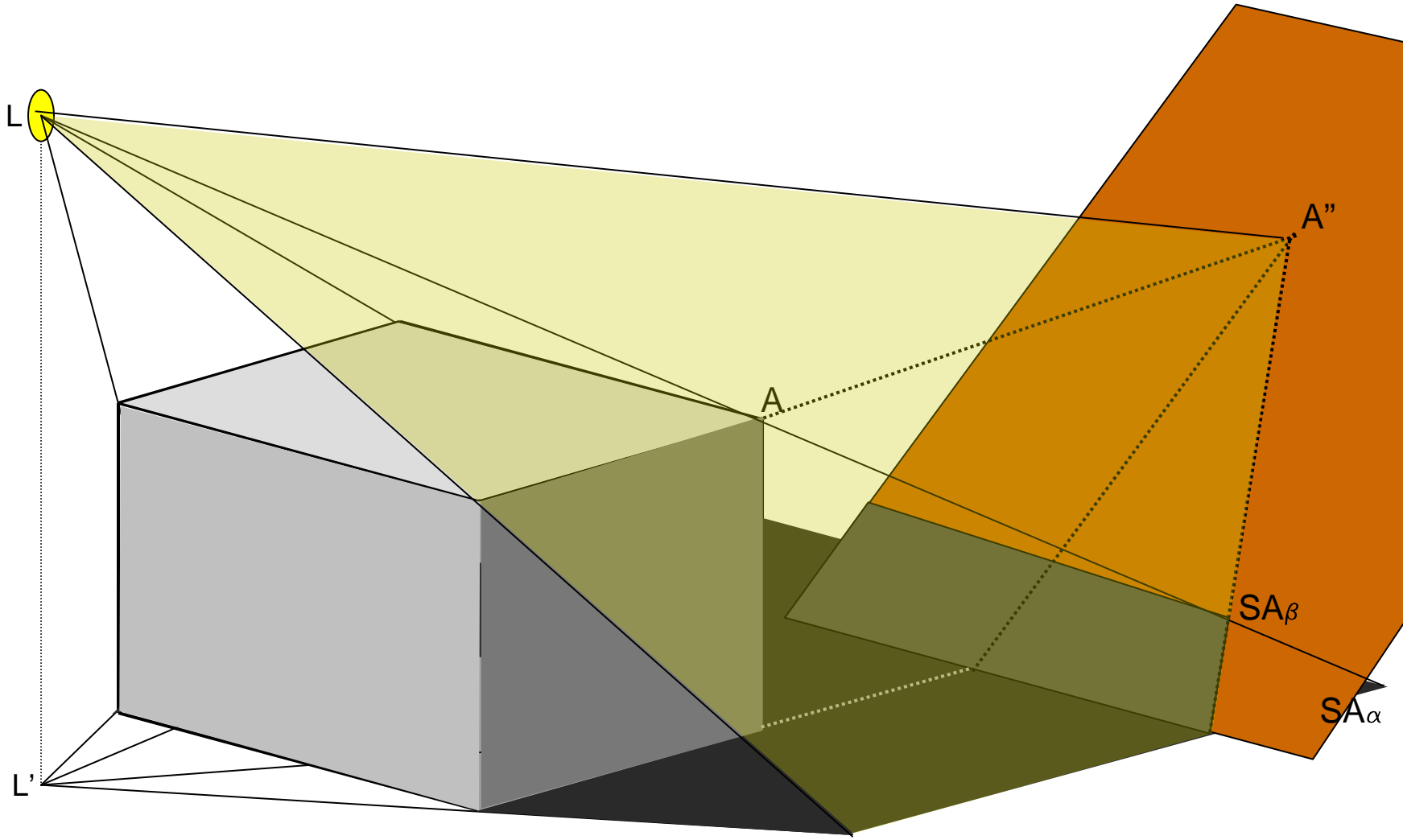

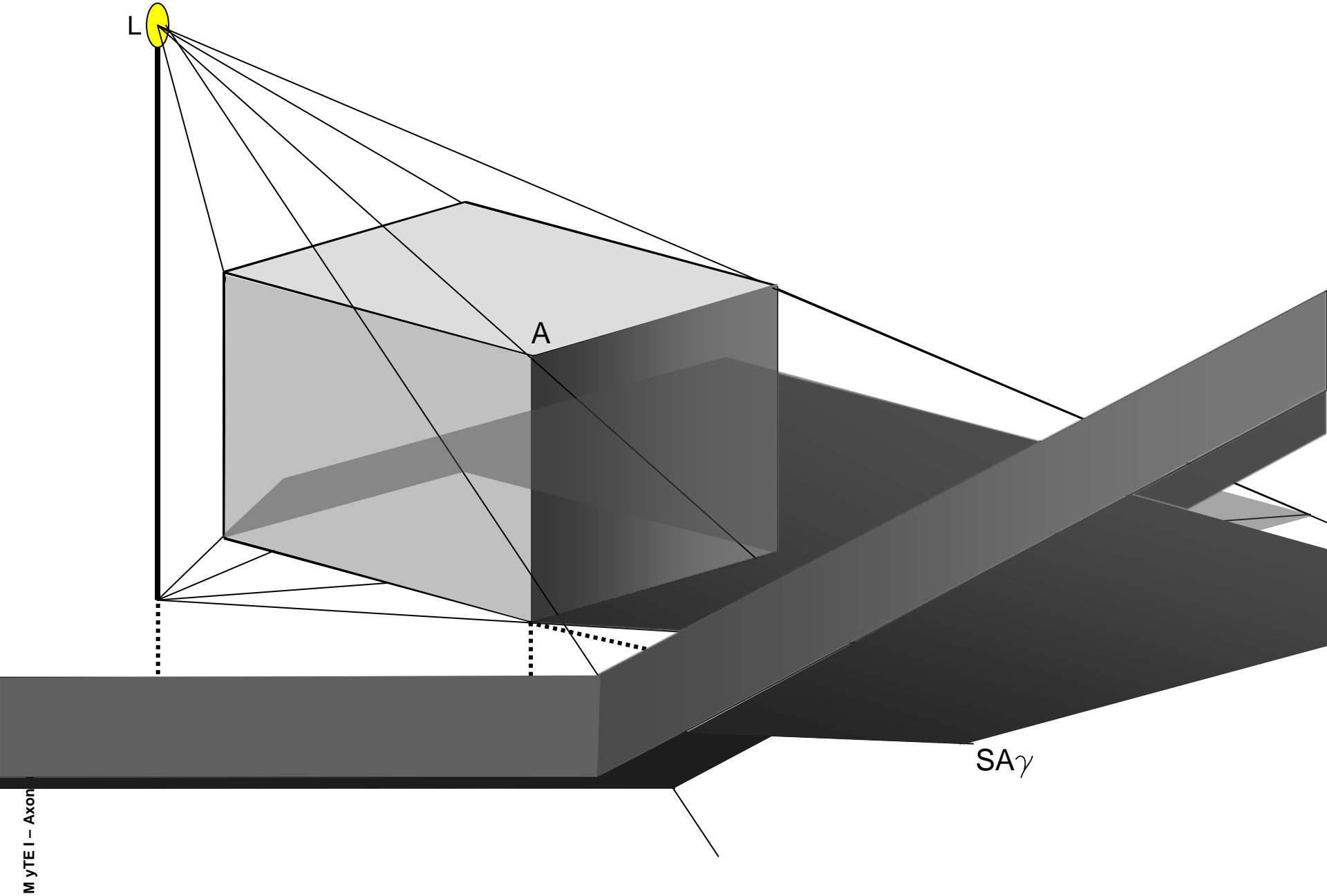

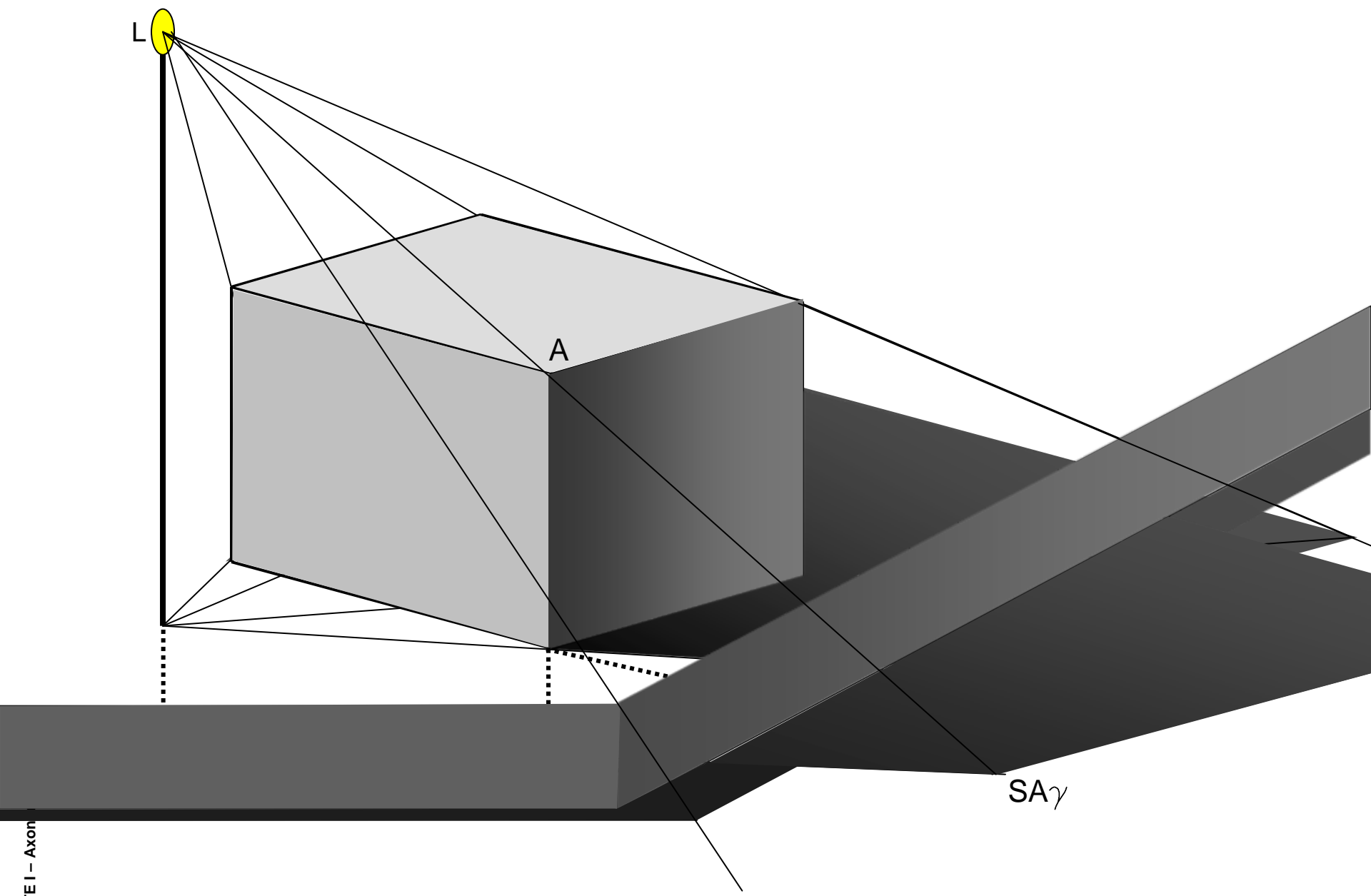

L

A

SA γ

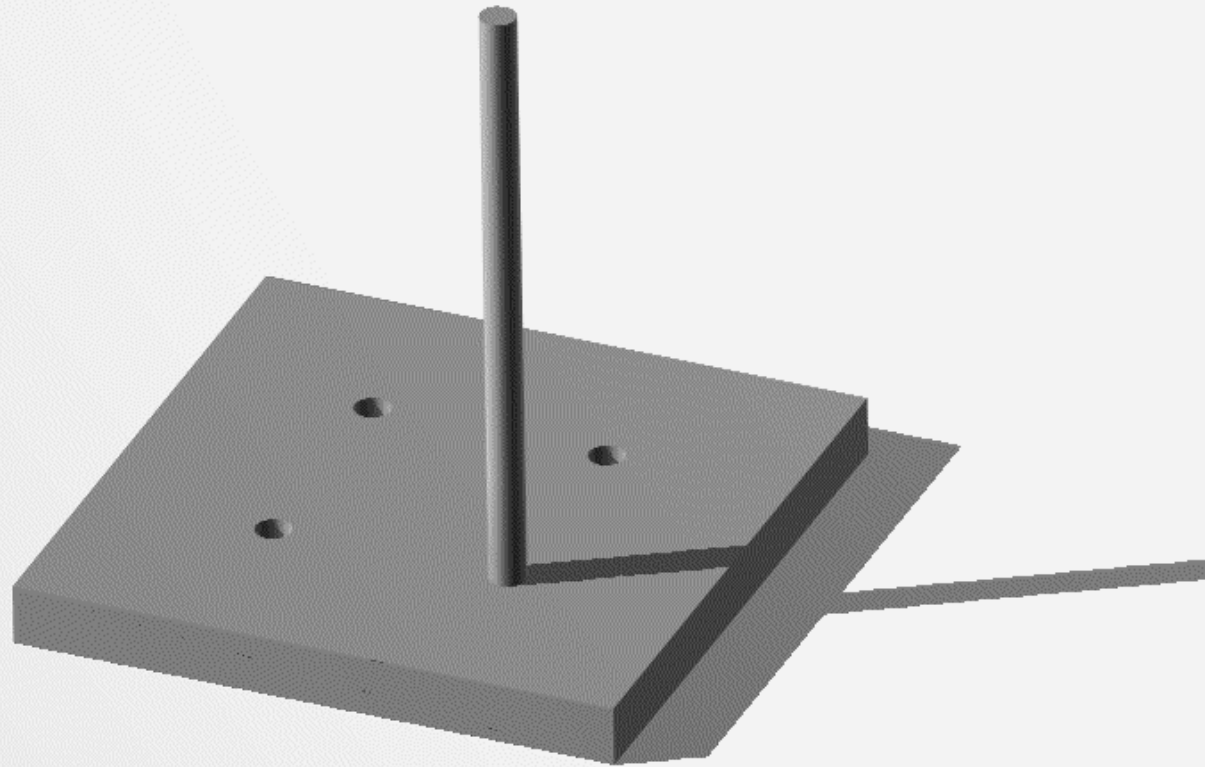

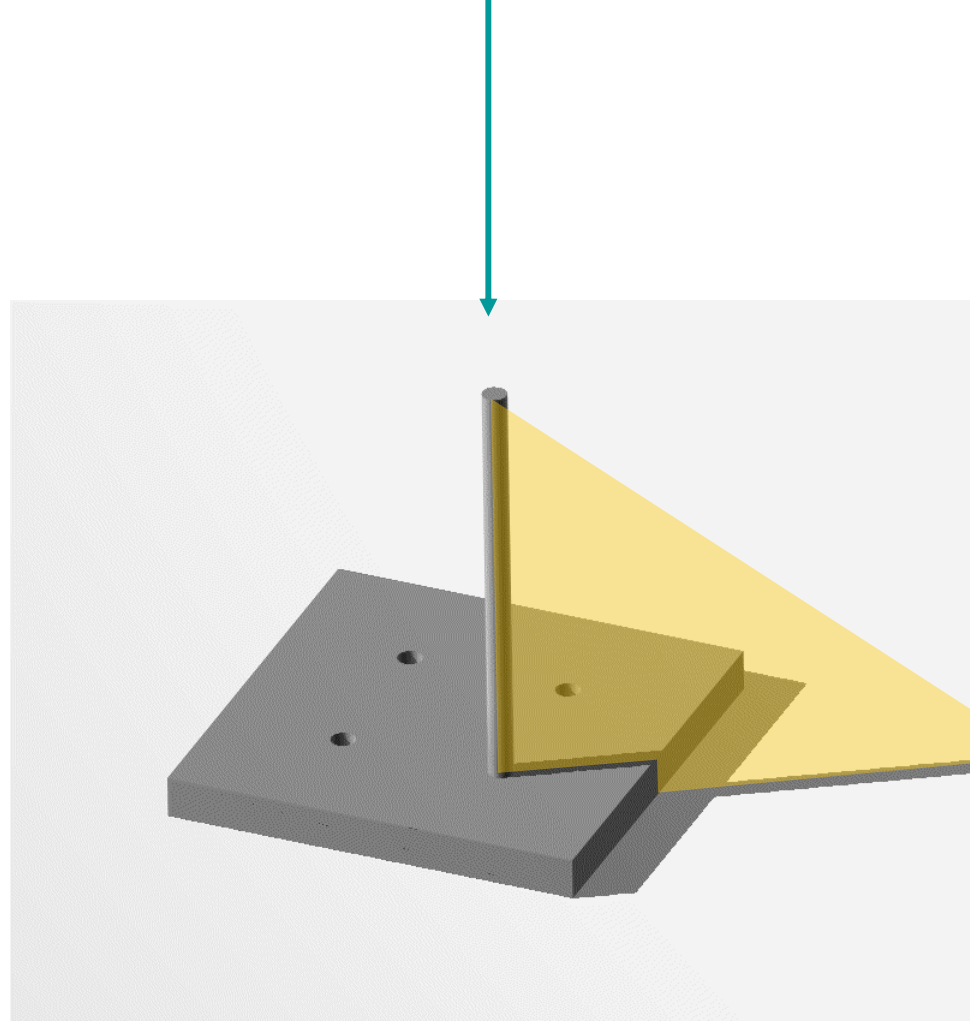
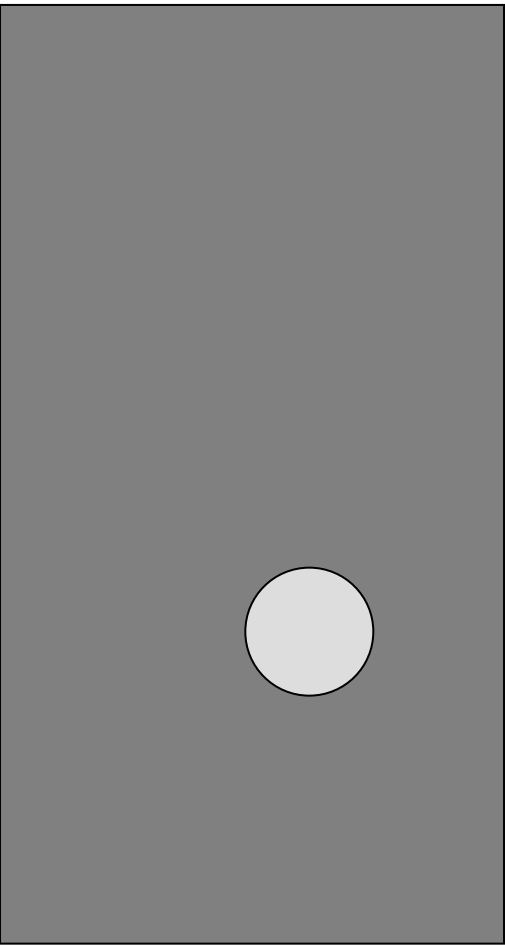

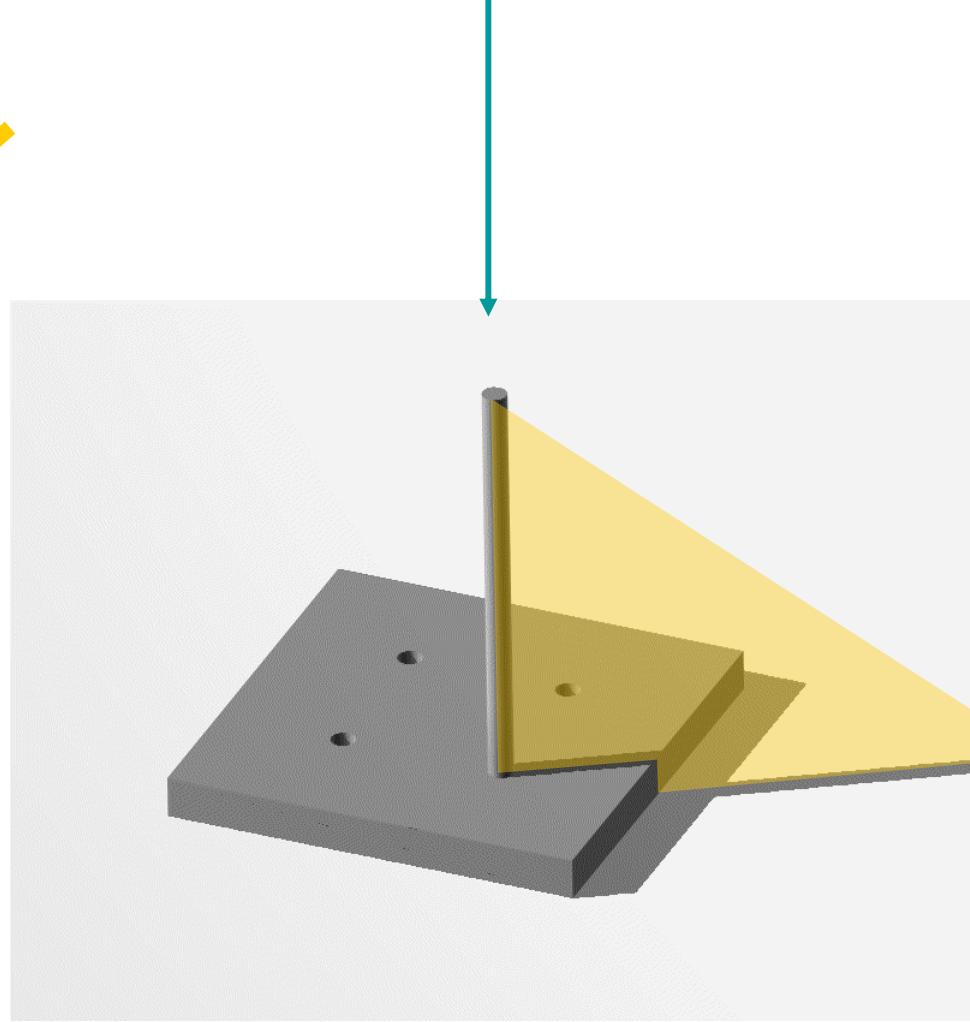
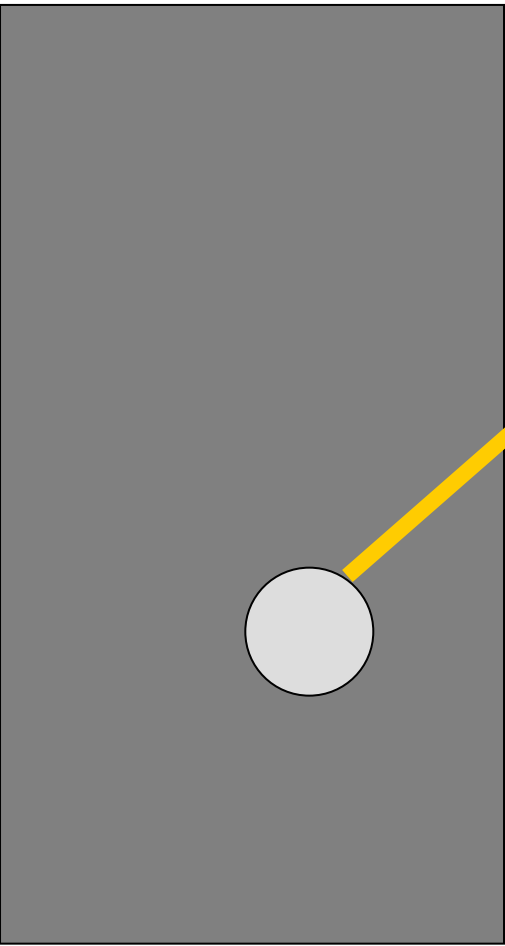

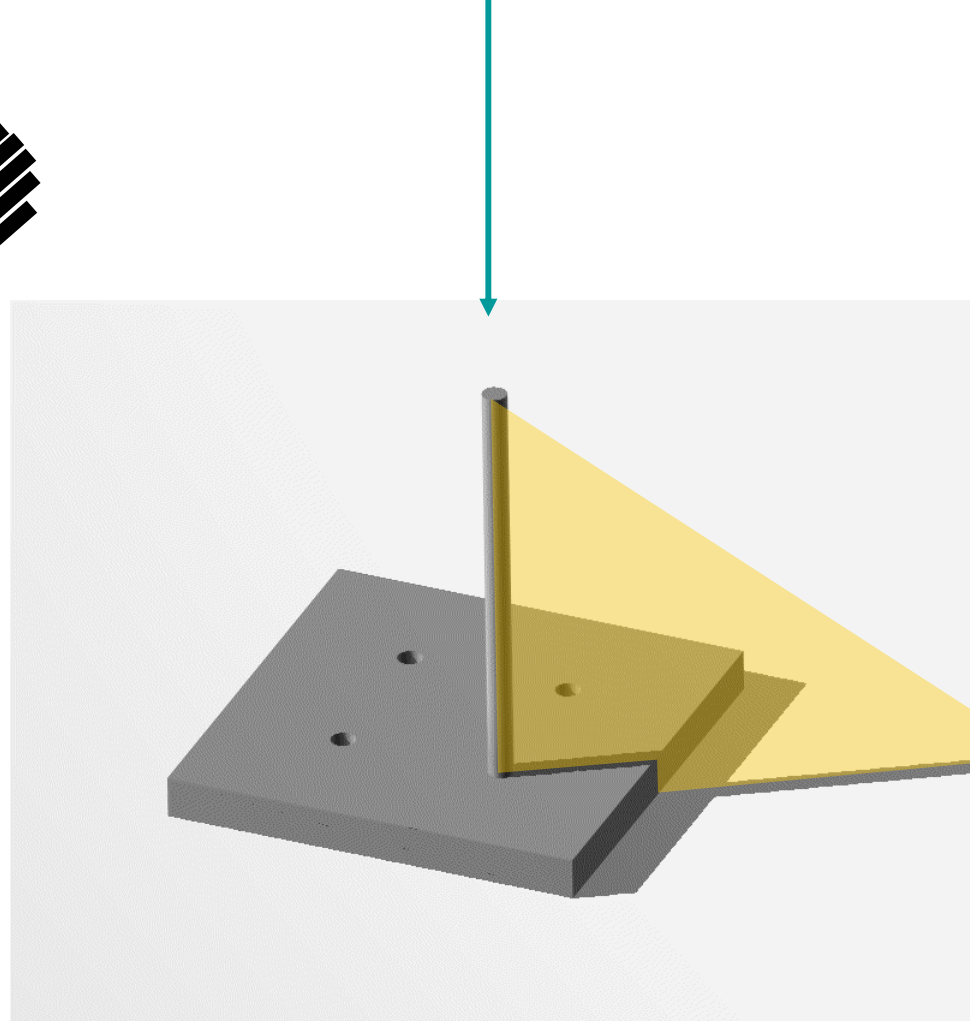
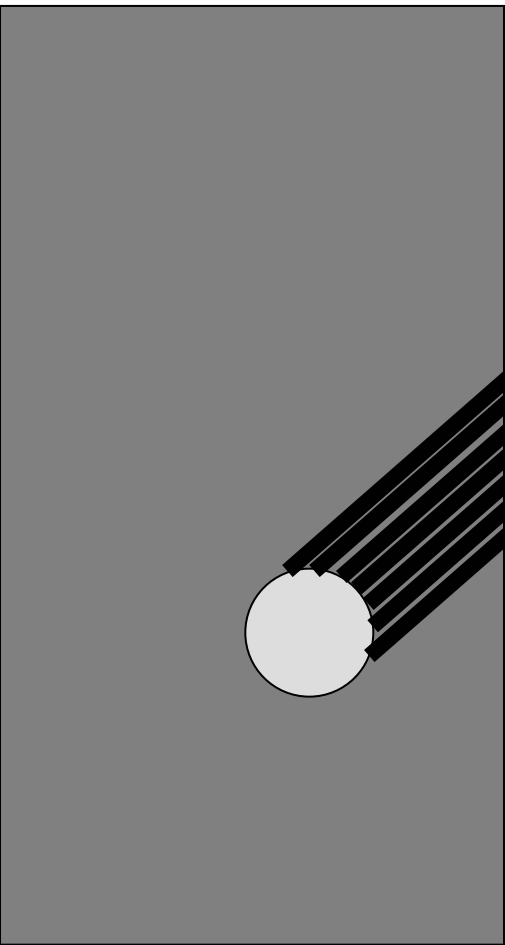

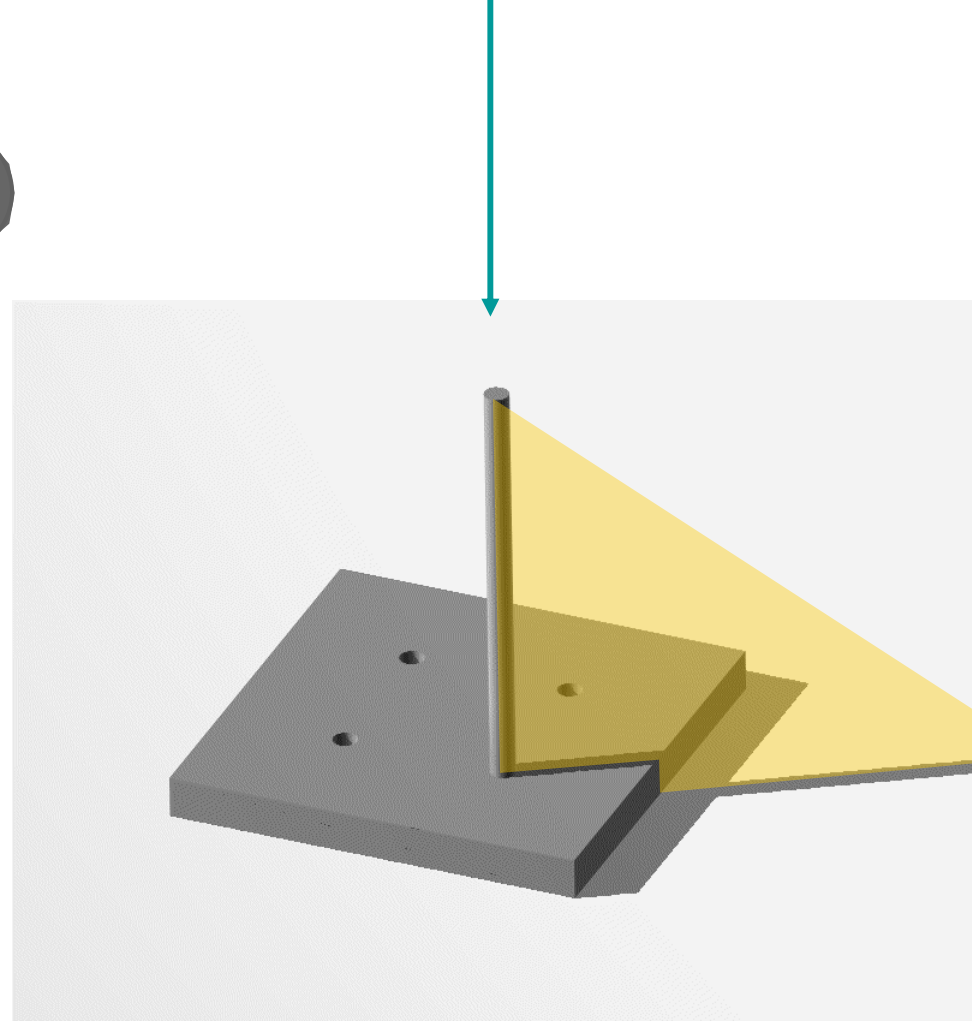
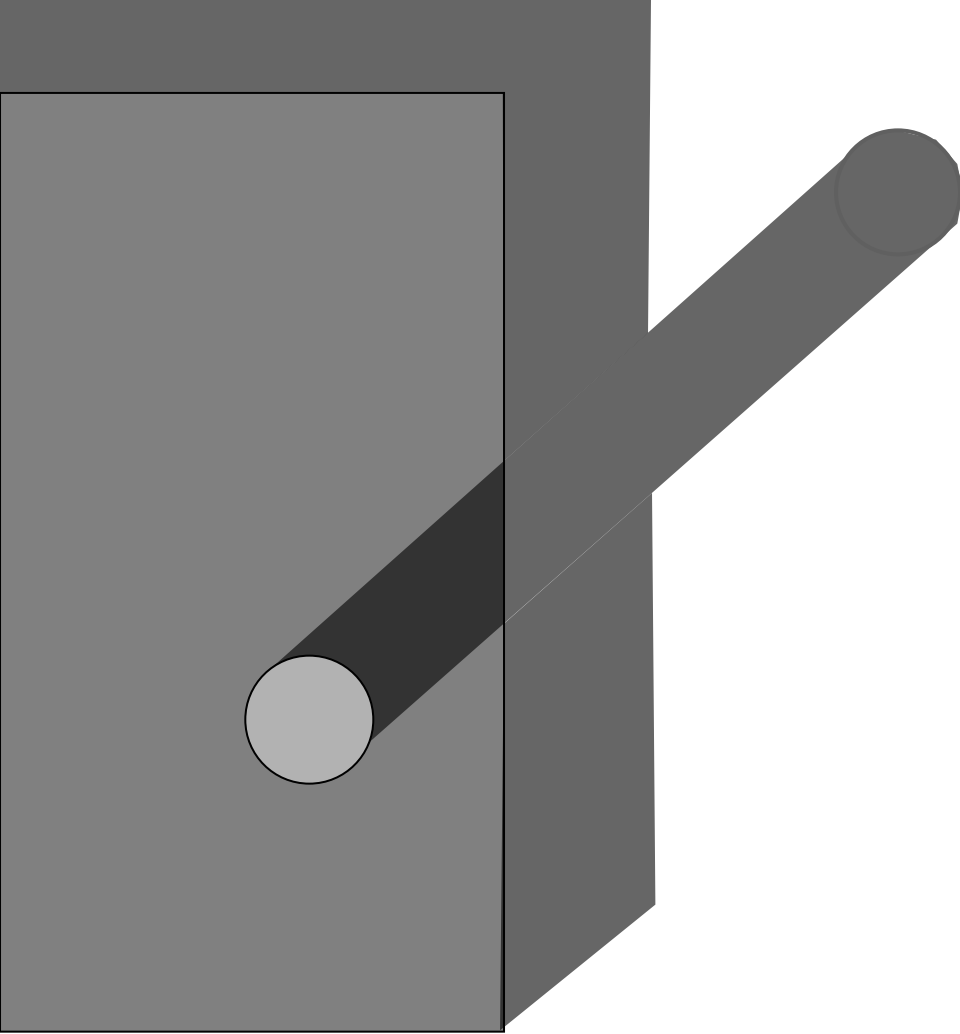

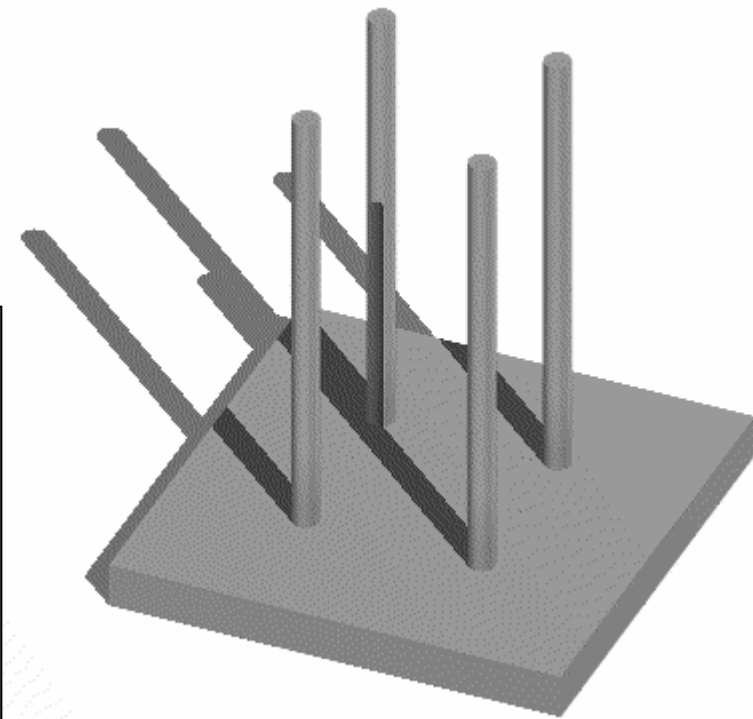
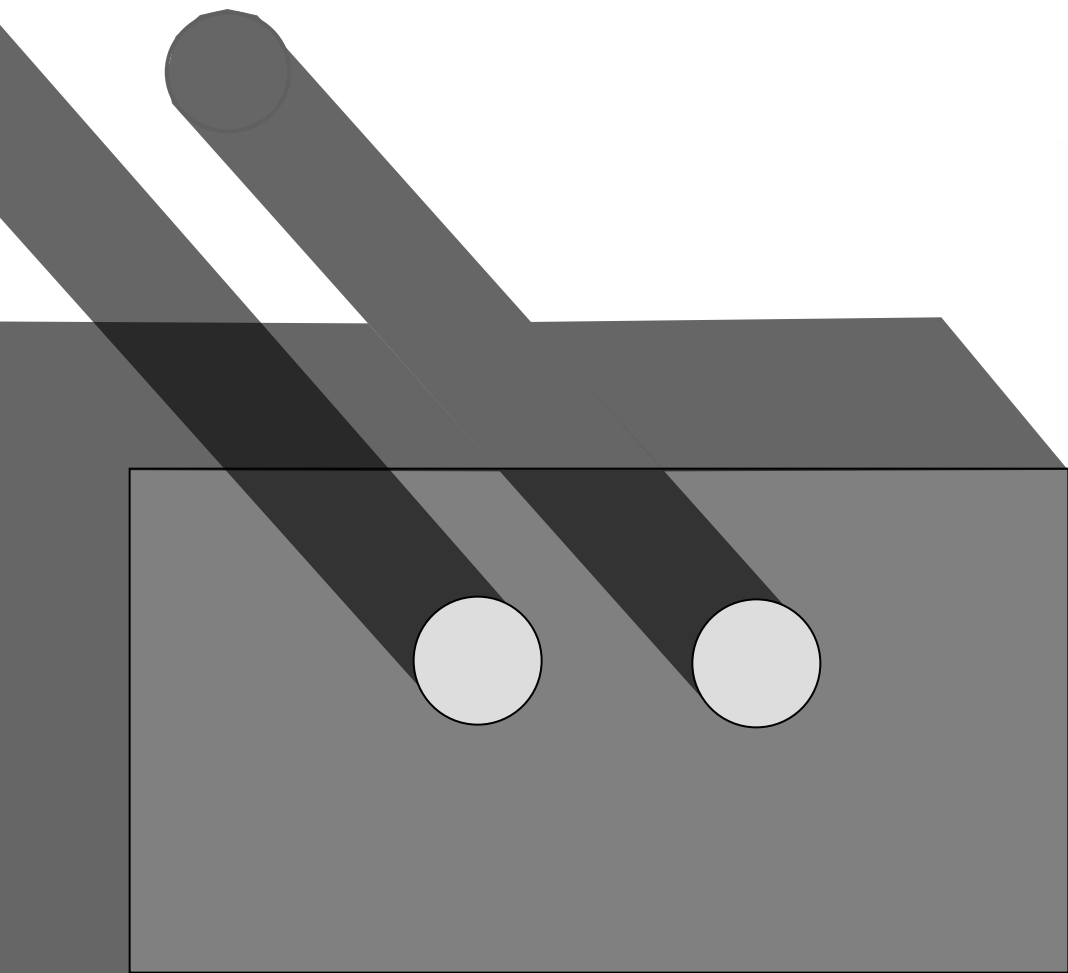

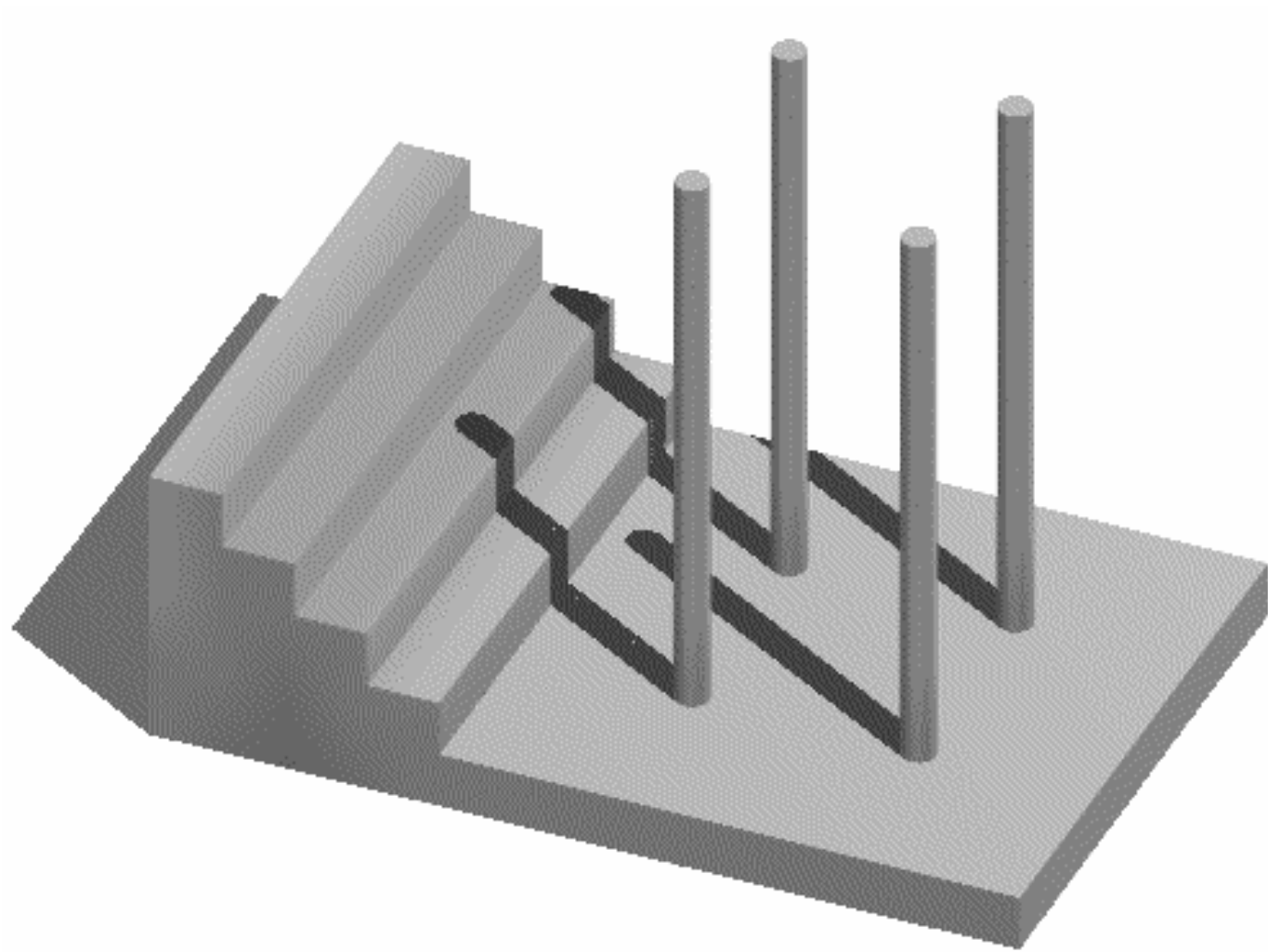

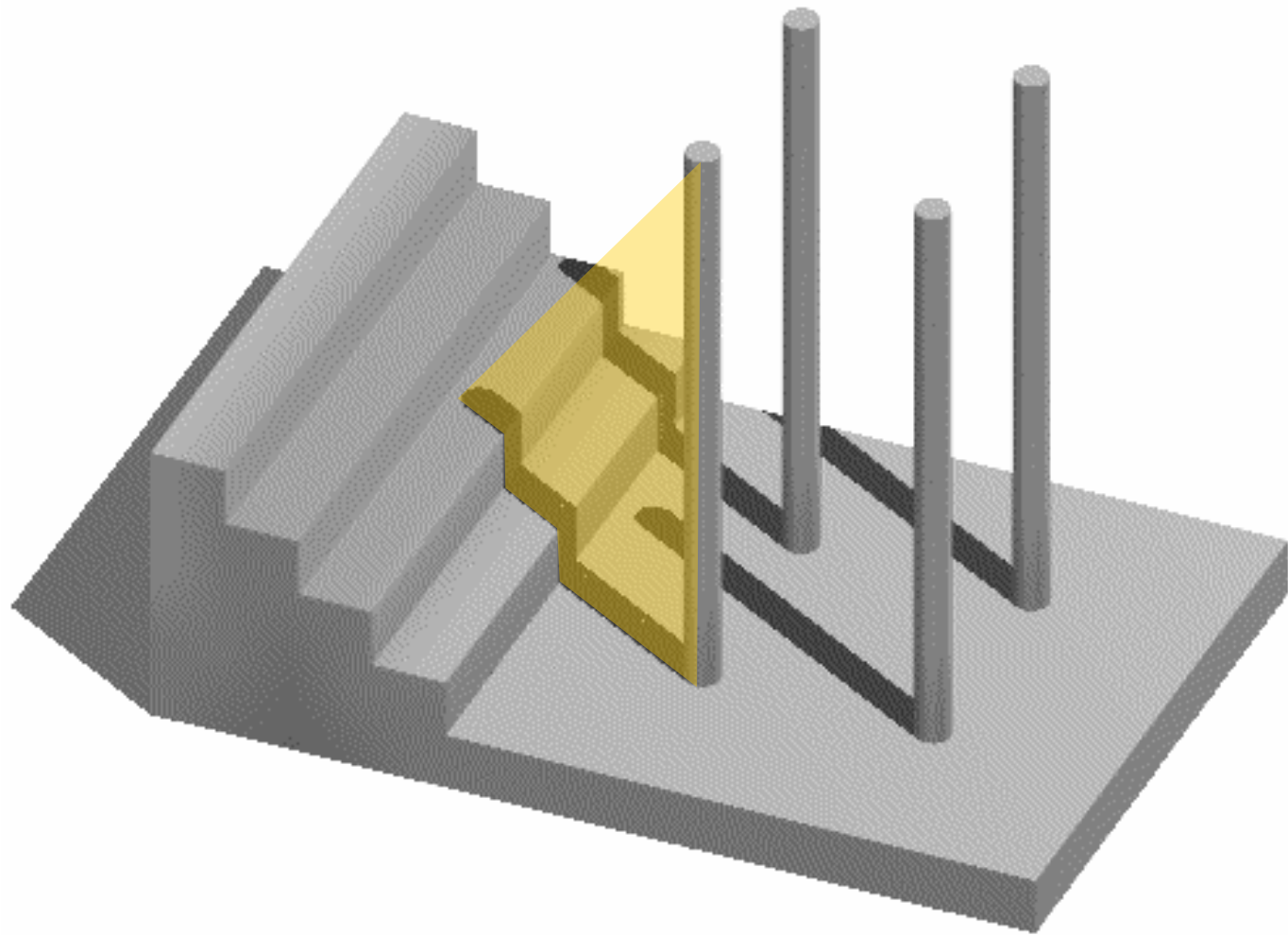

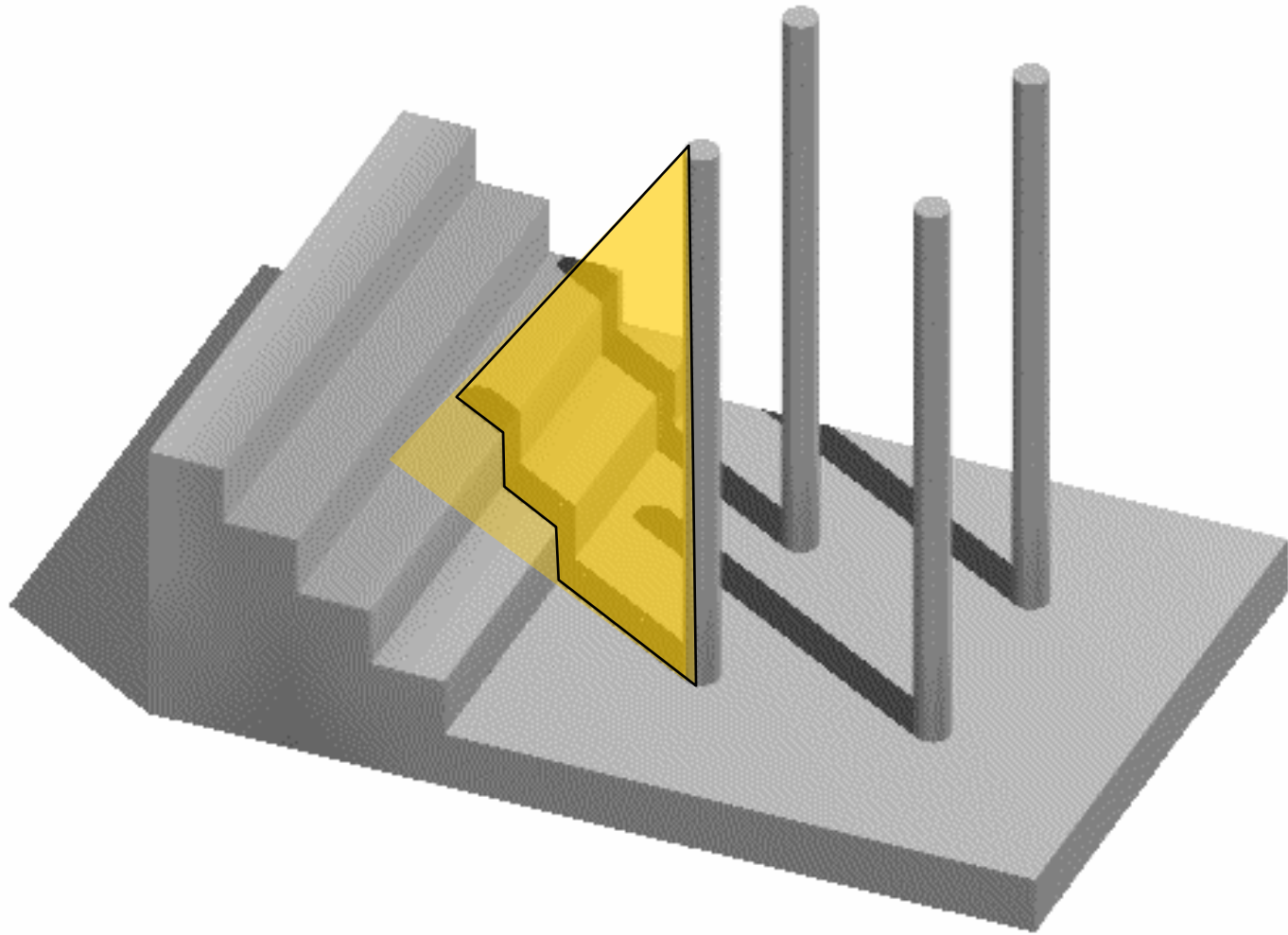

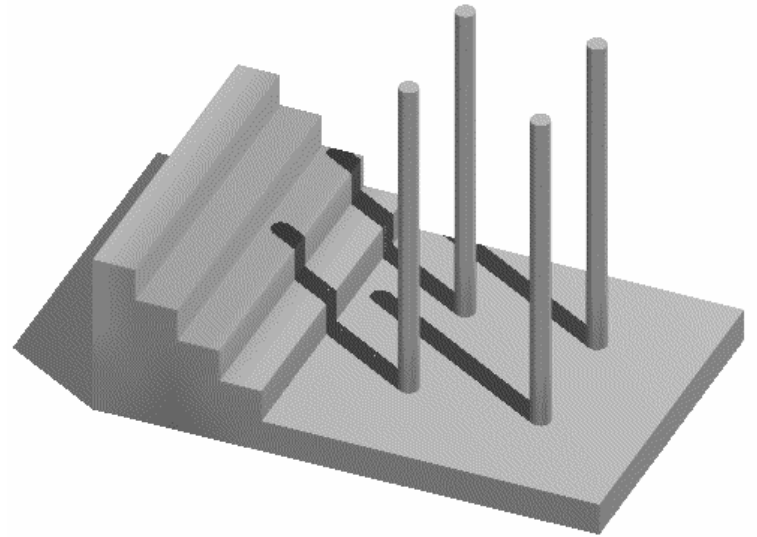
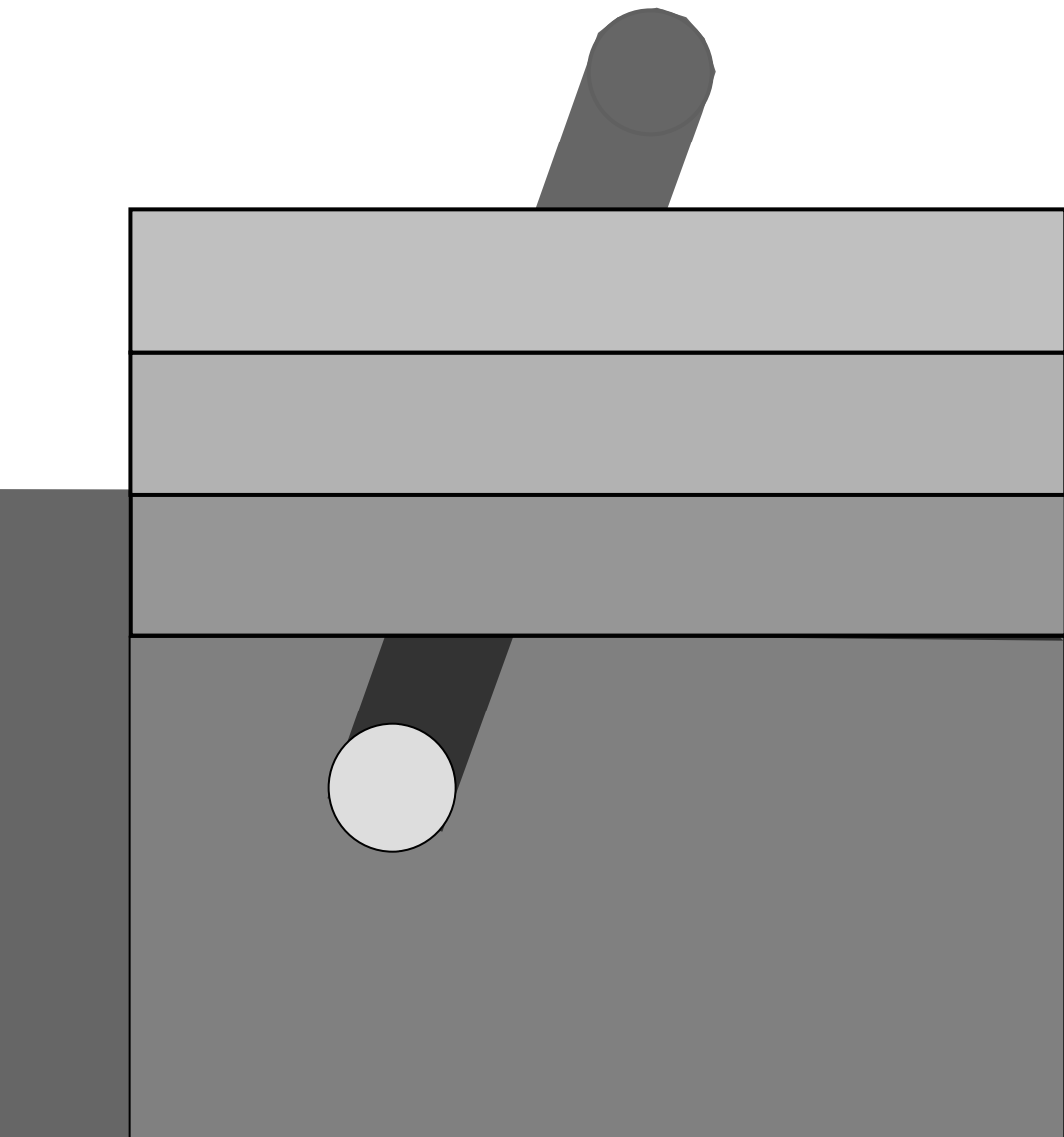

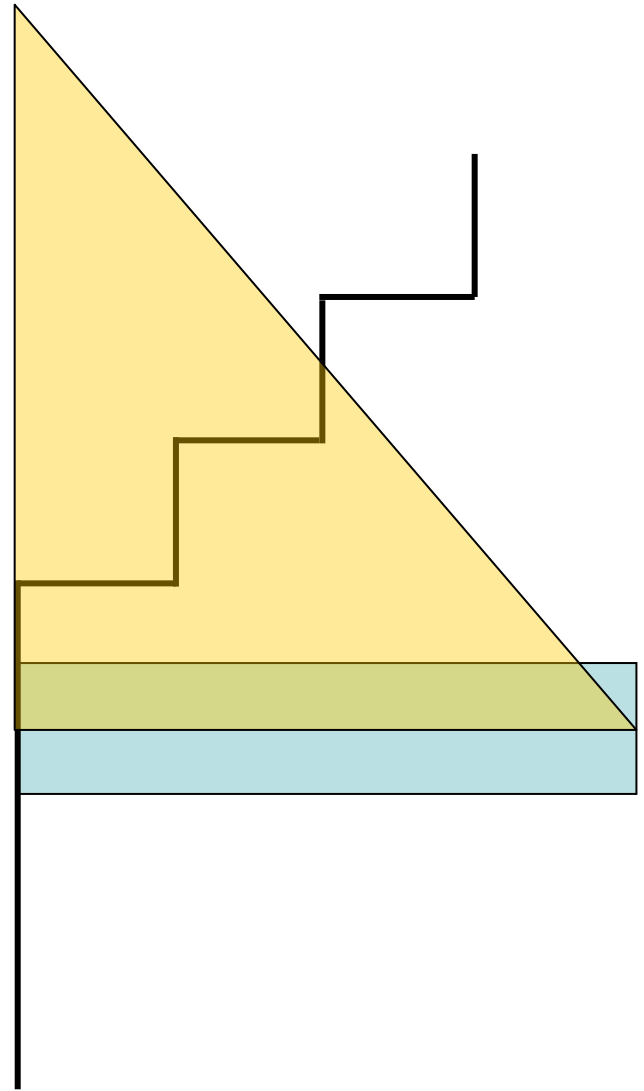
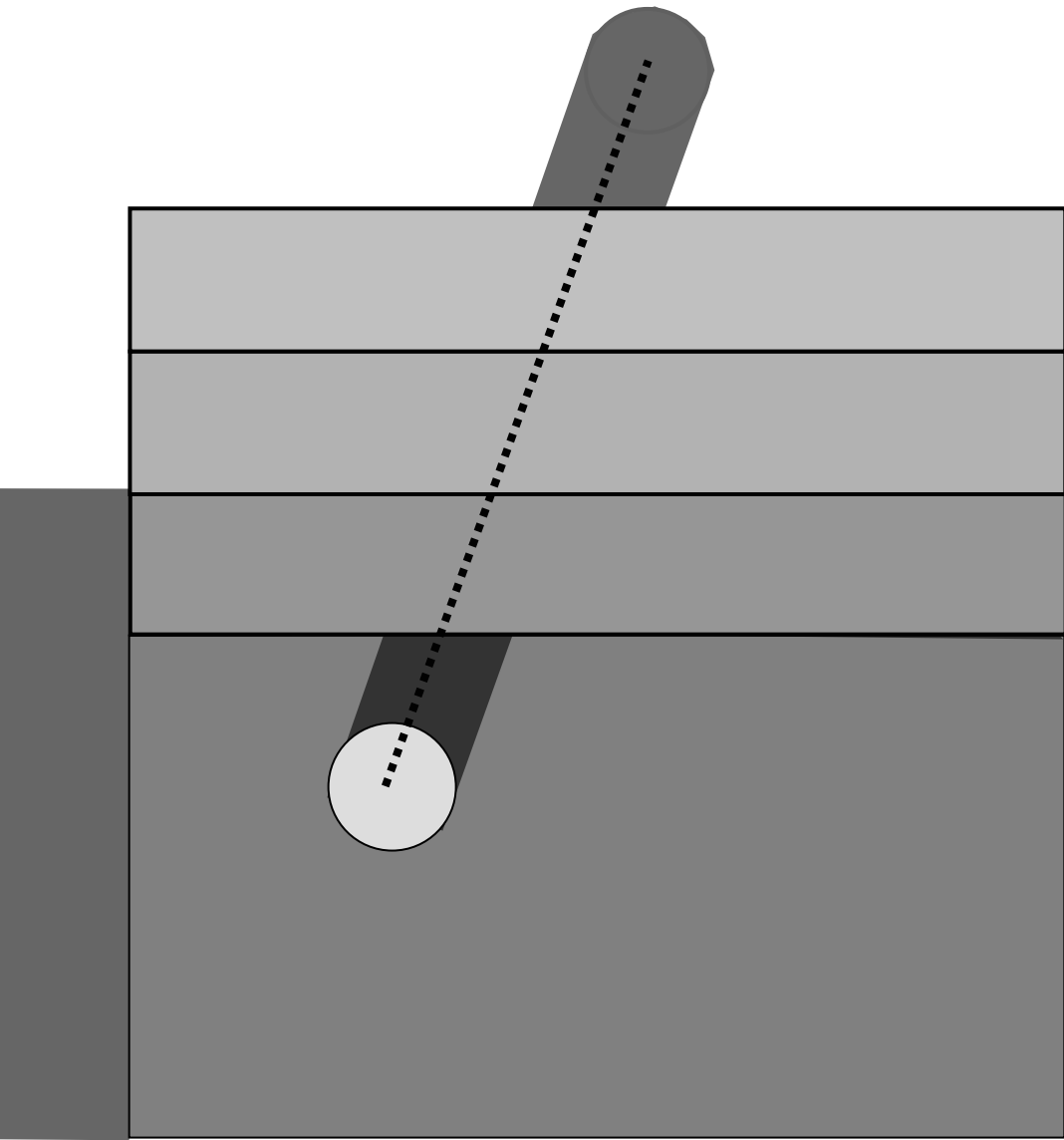

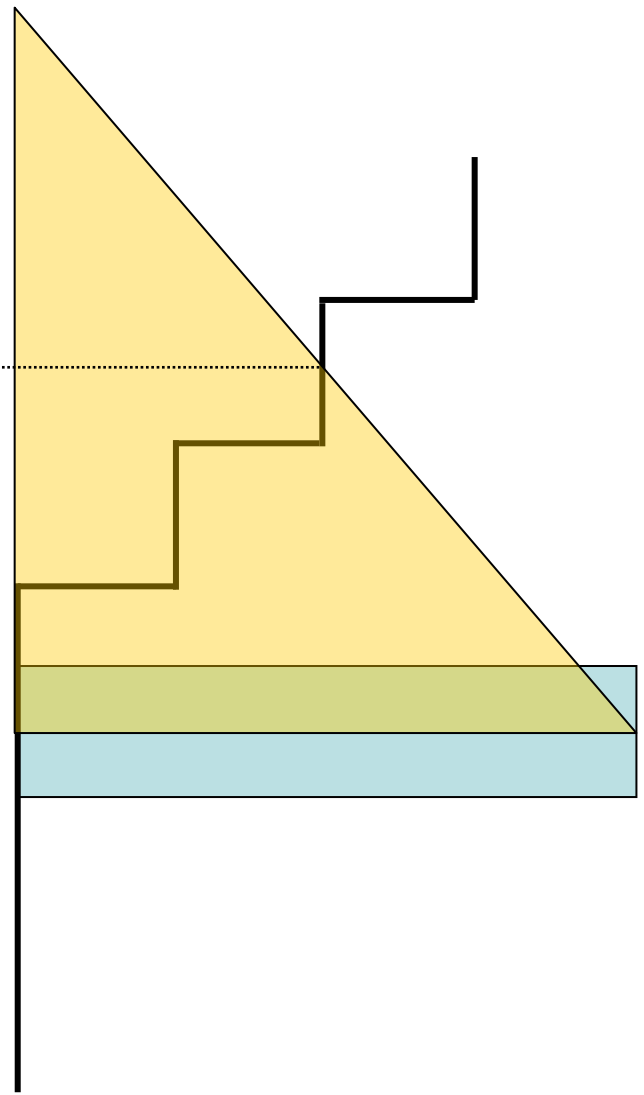
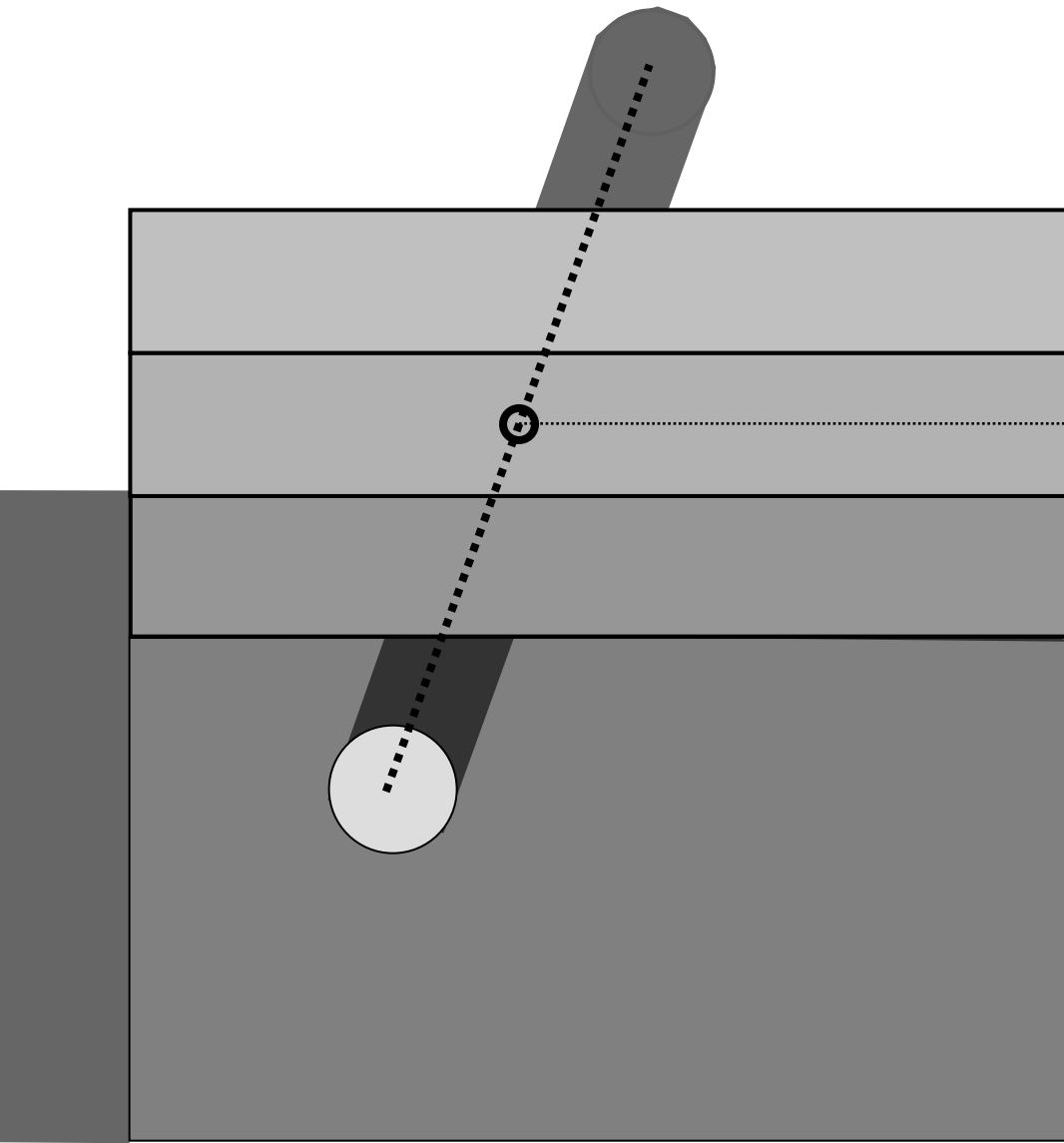

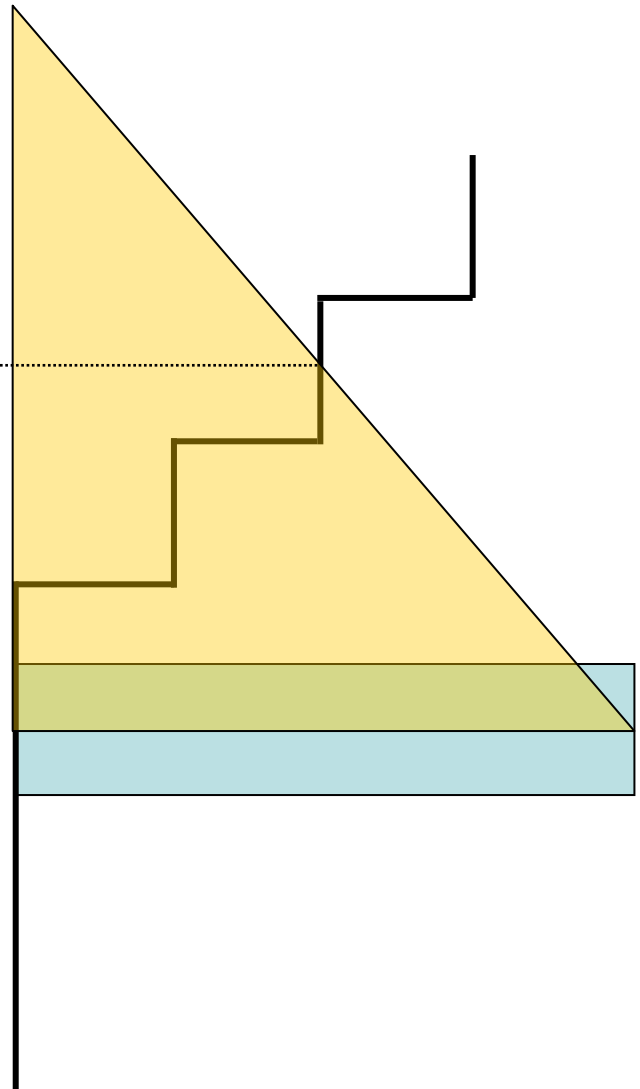
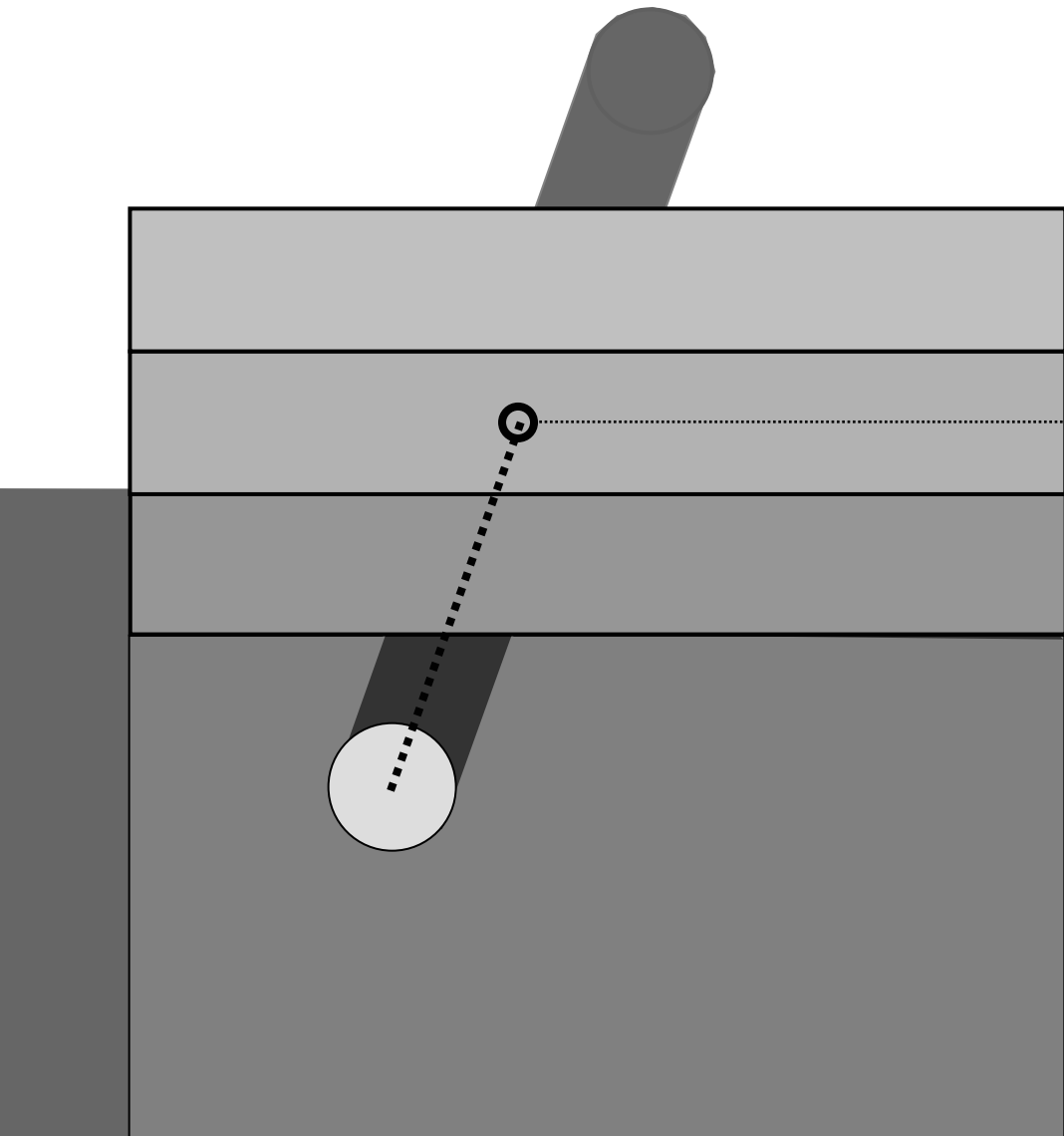

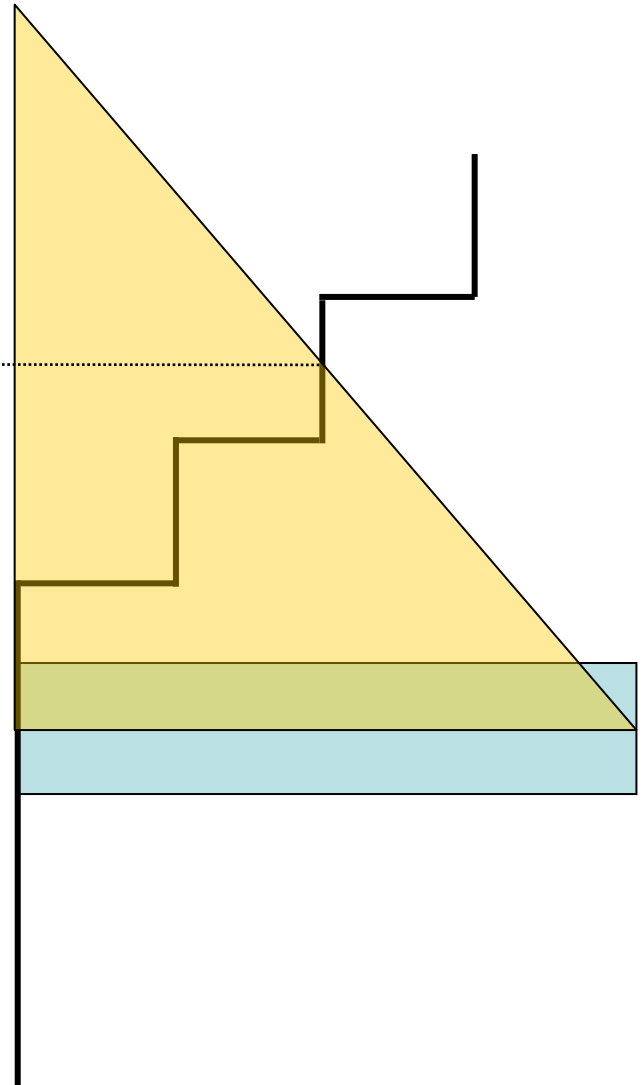
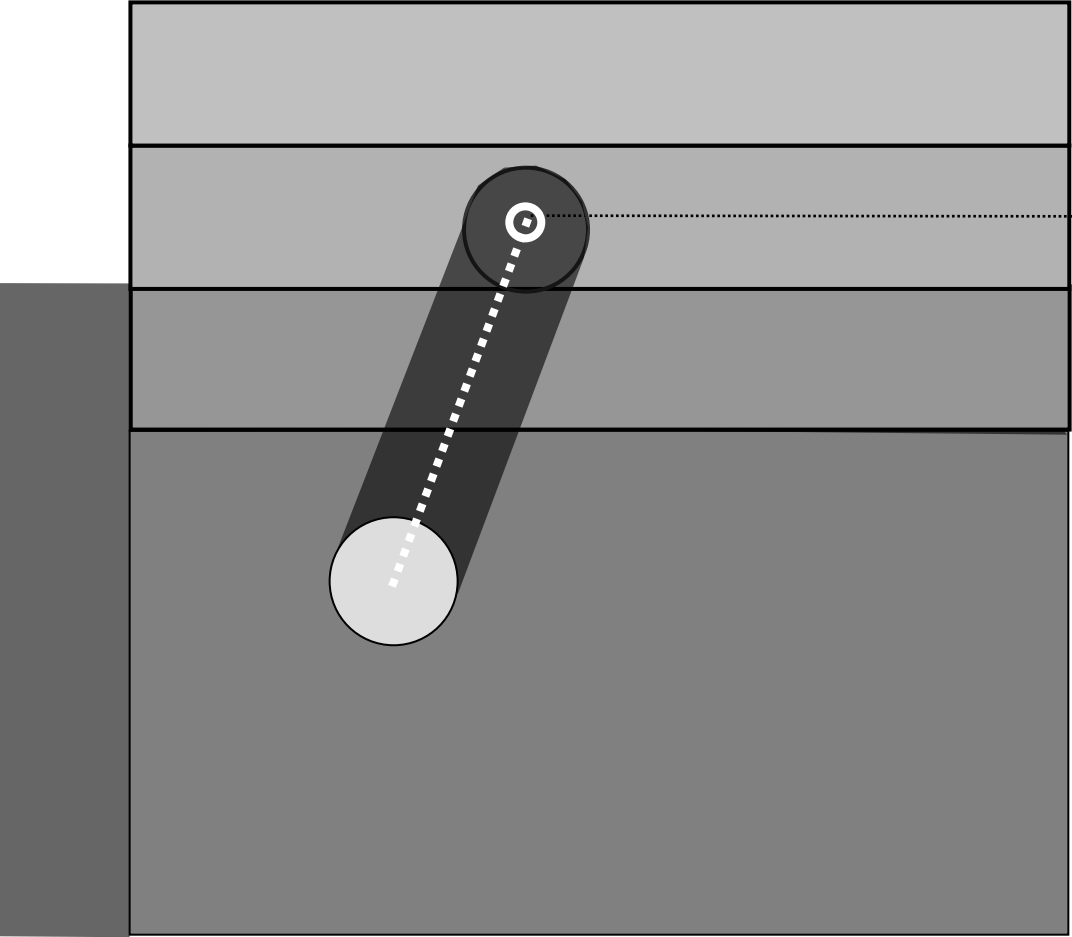

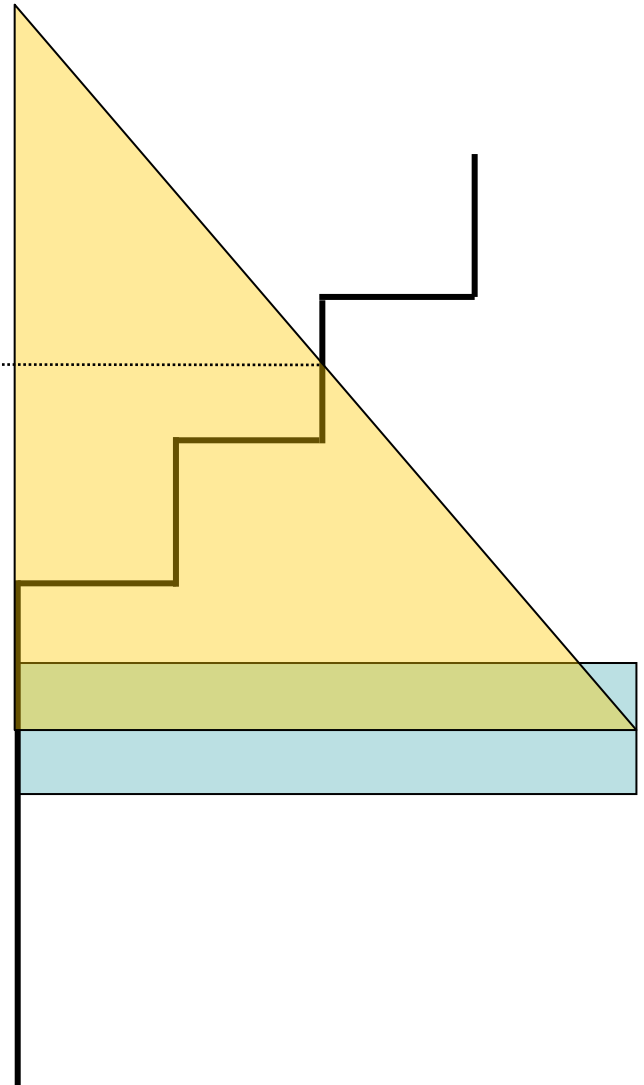
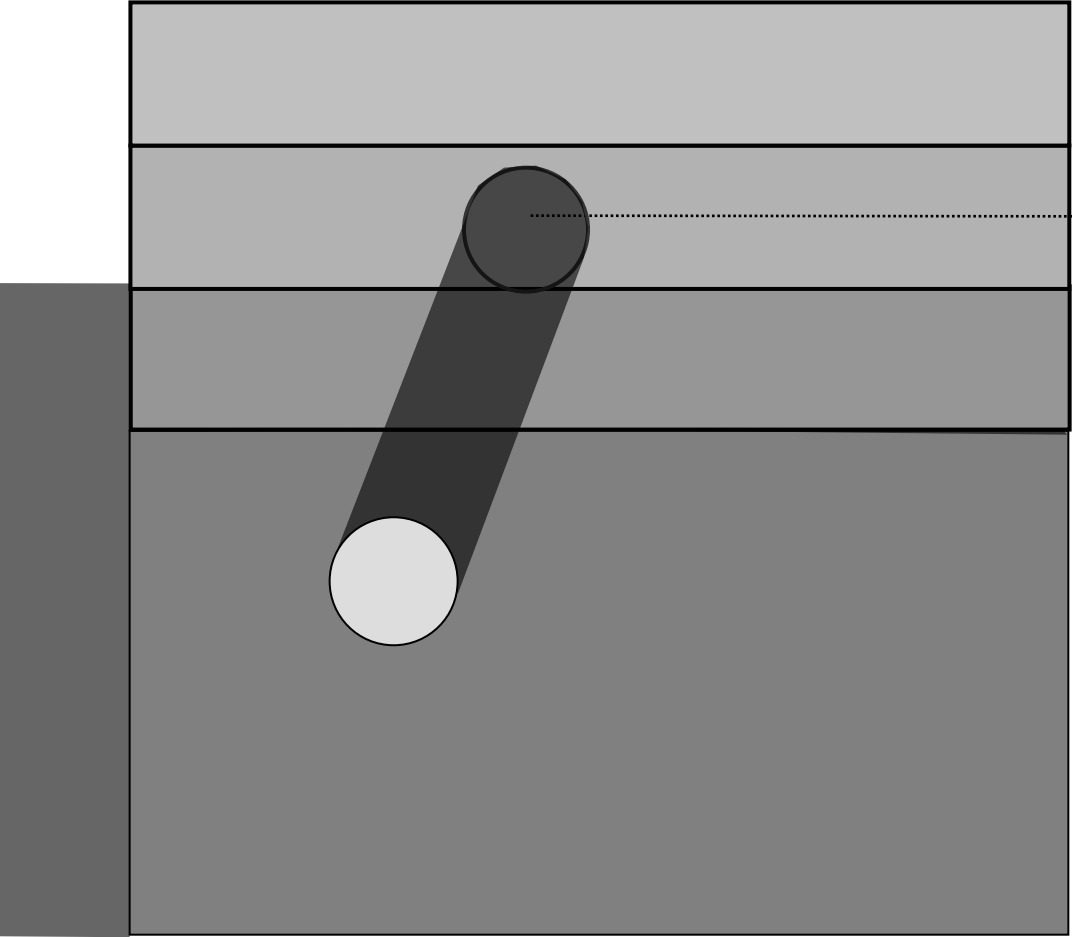

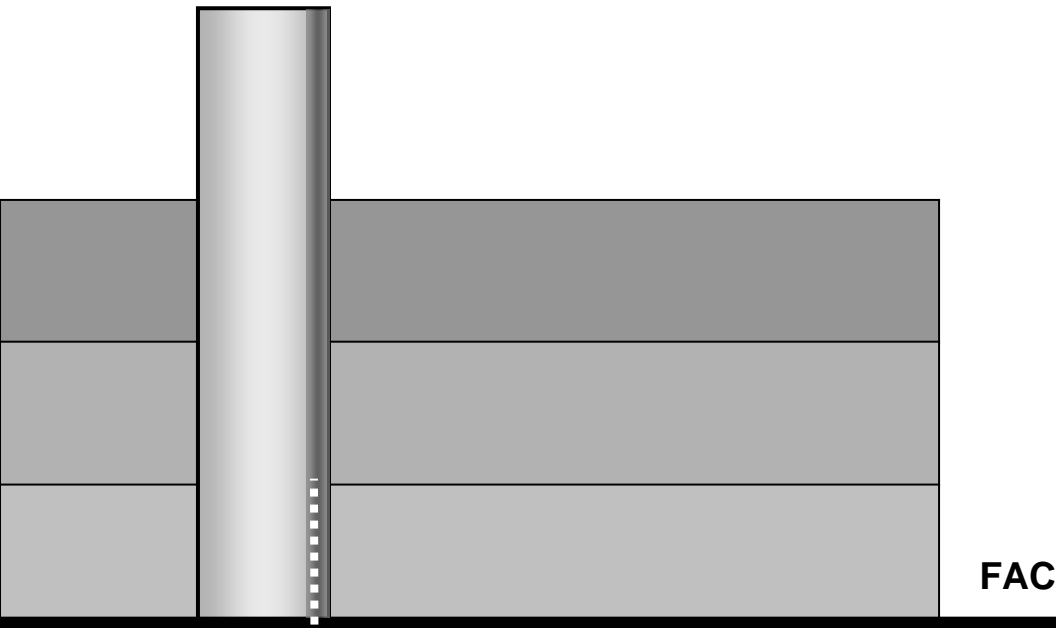

FACHADA

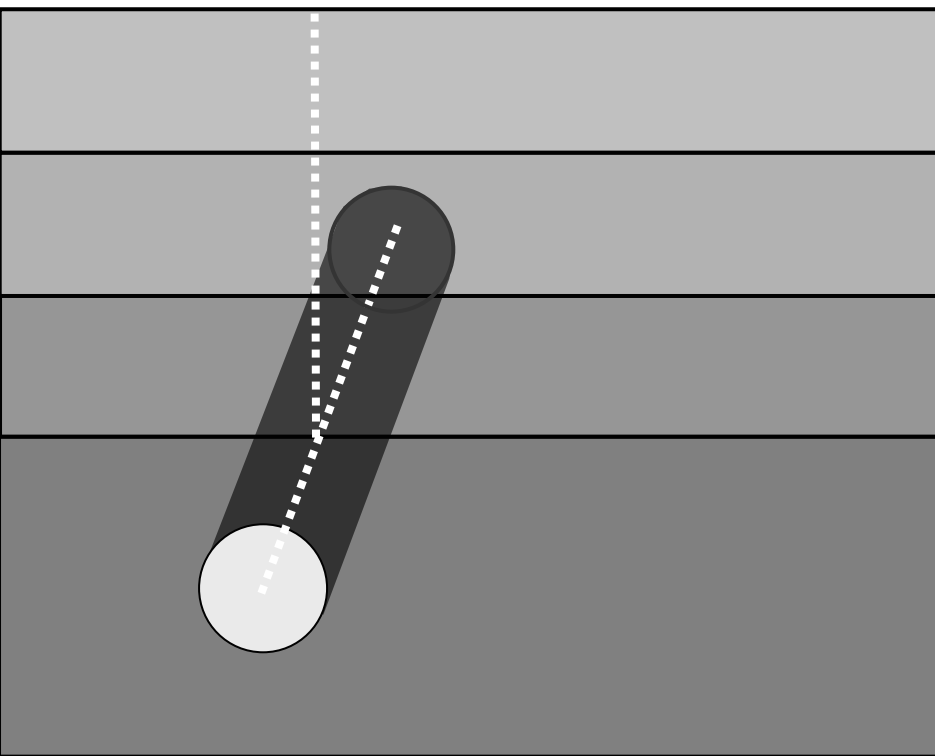

PLANTA

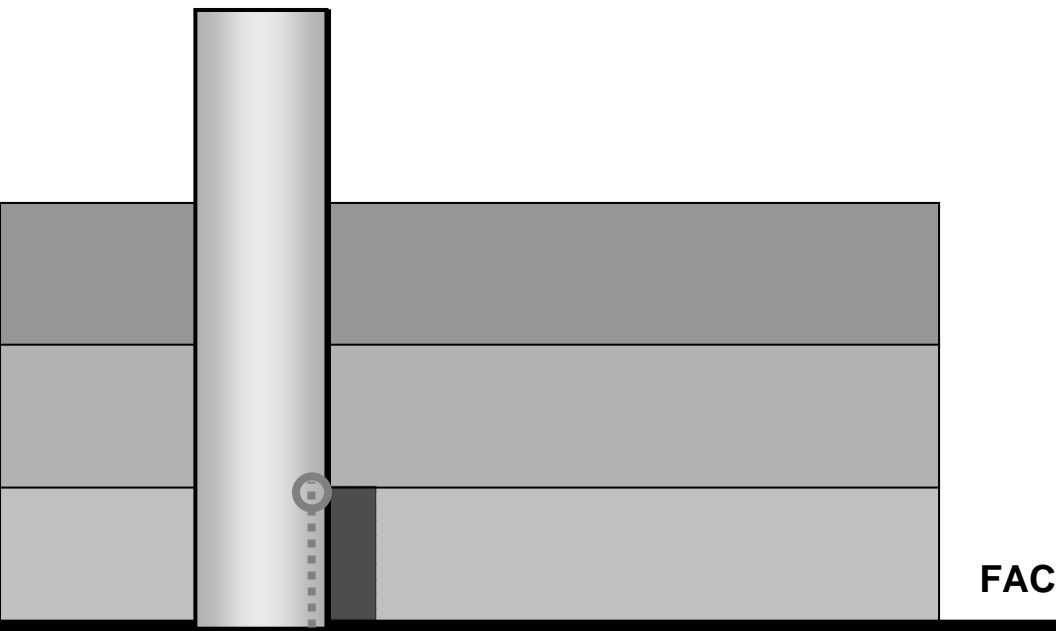

FACHADA

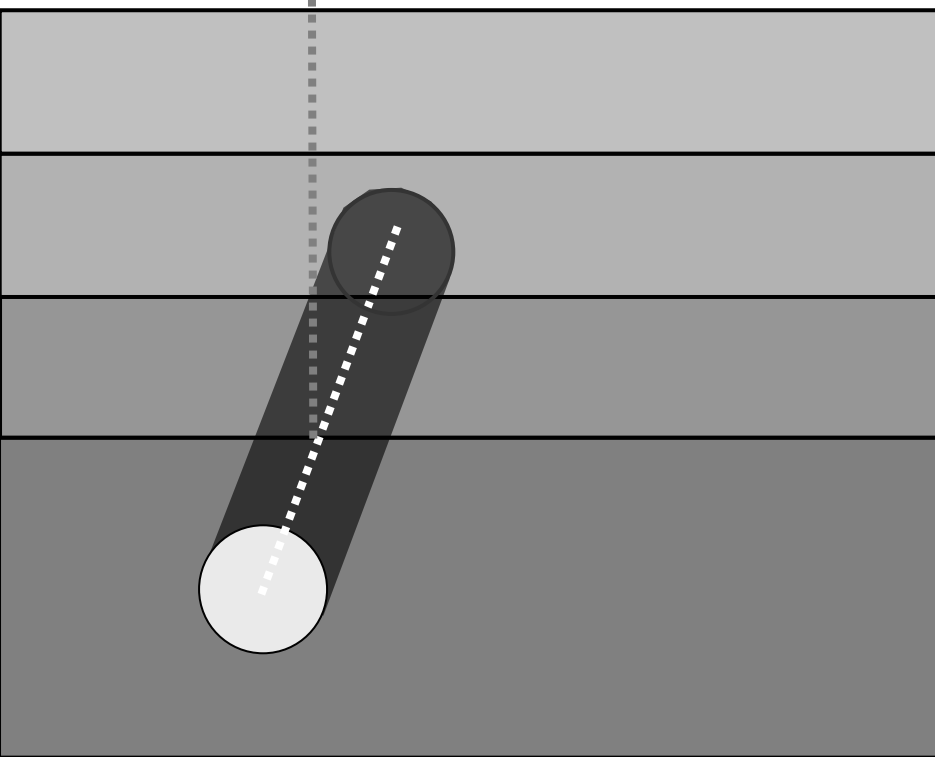

PLANTA

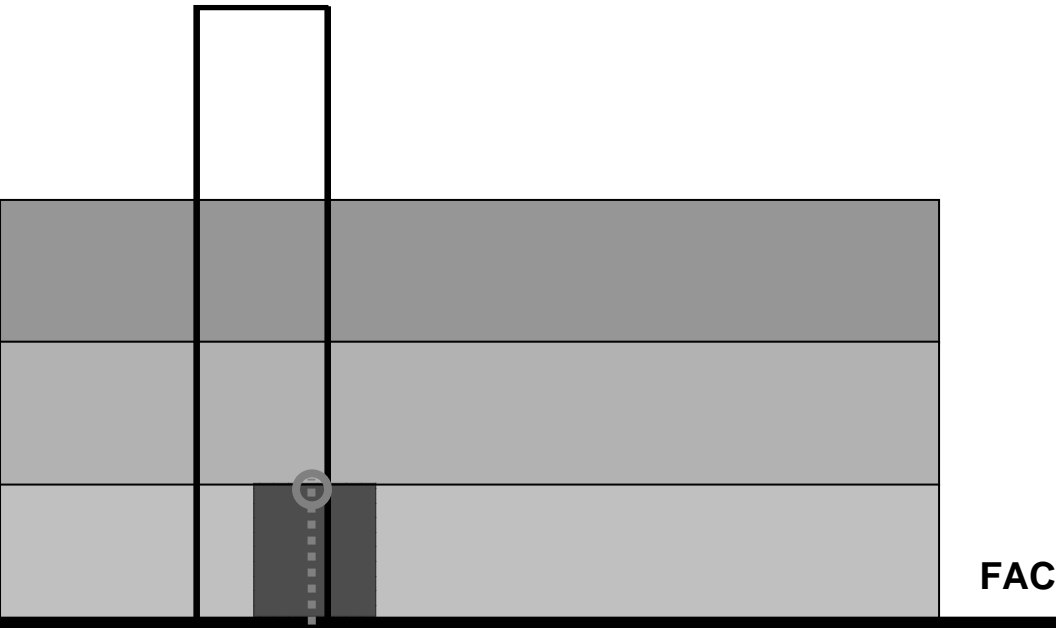

FACHADA

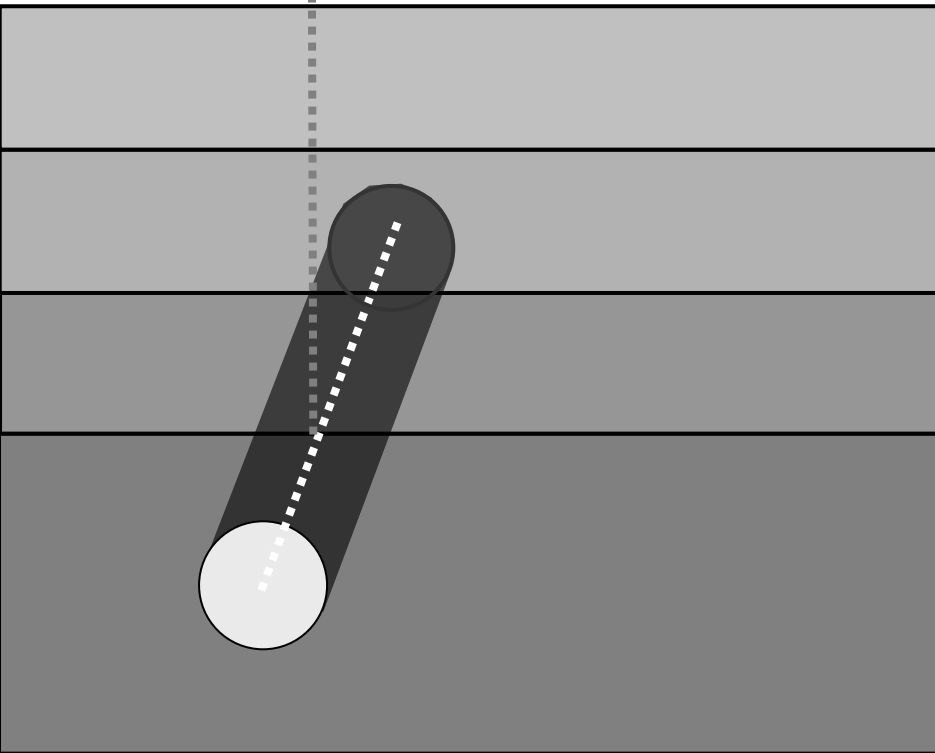

PLANTA

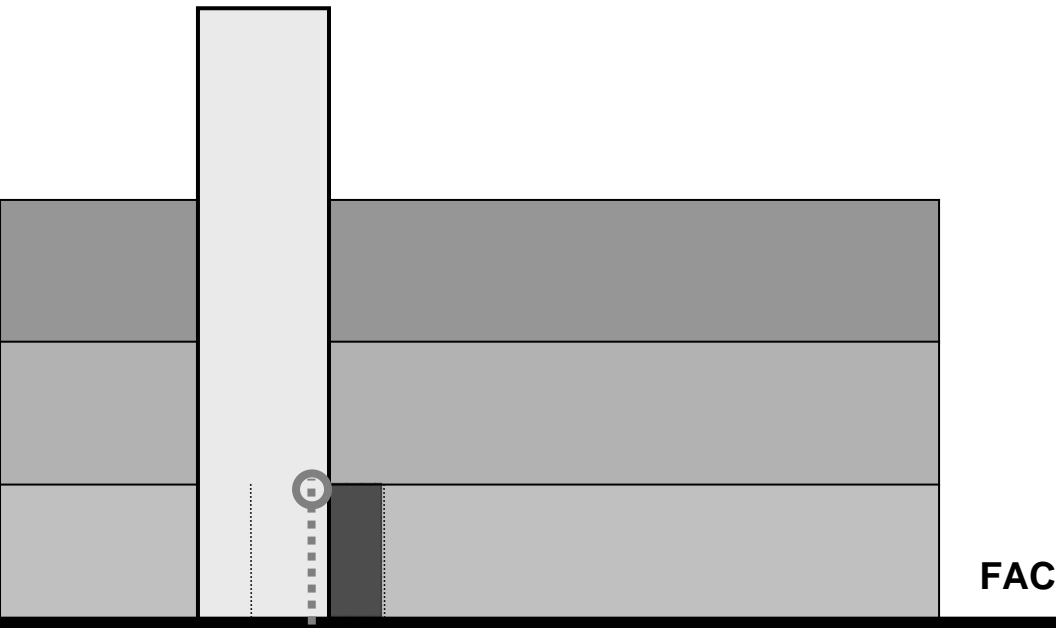

FACHADA

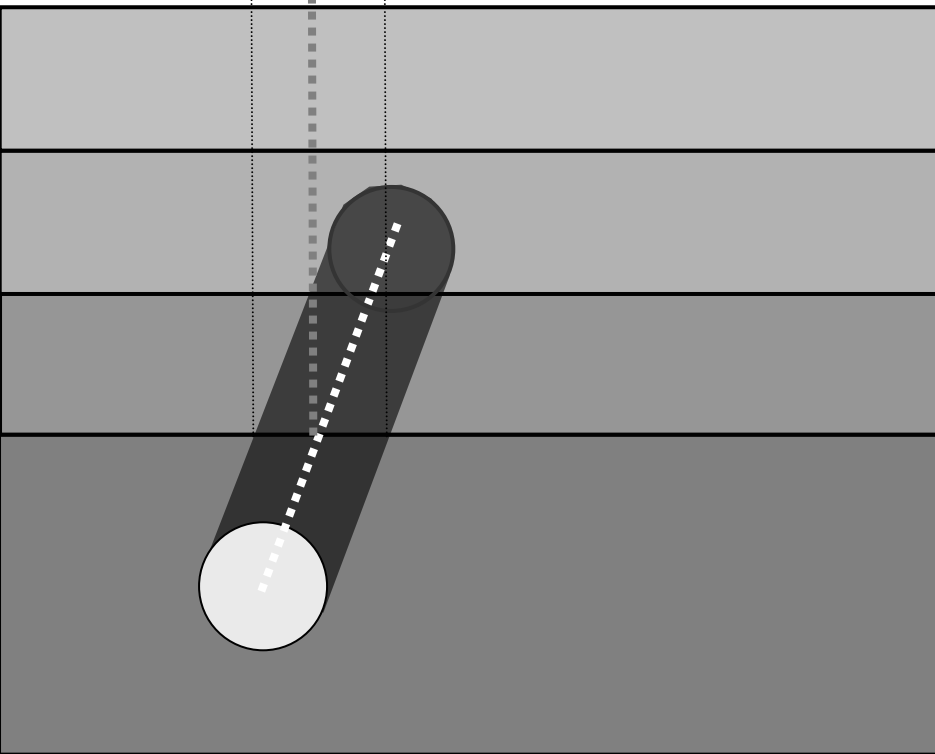

PLANTA

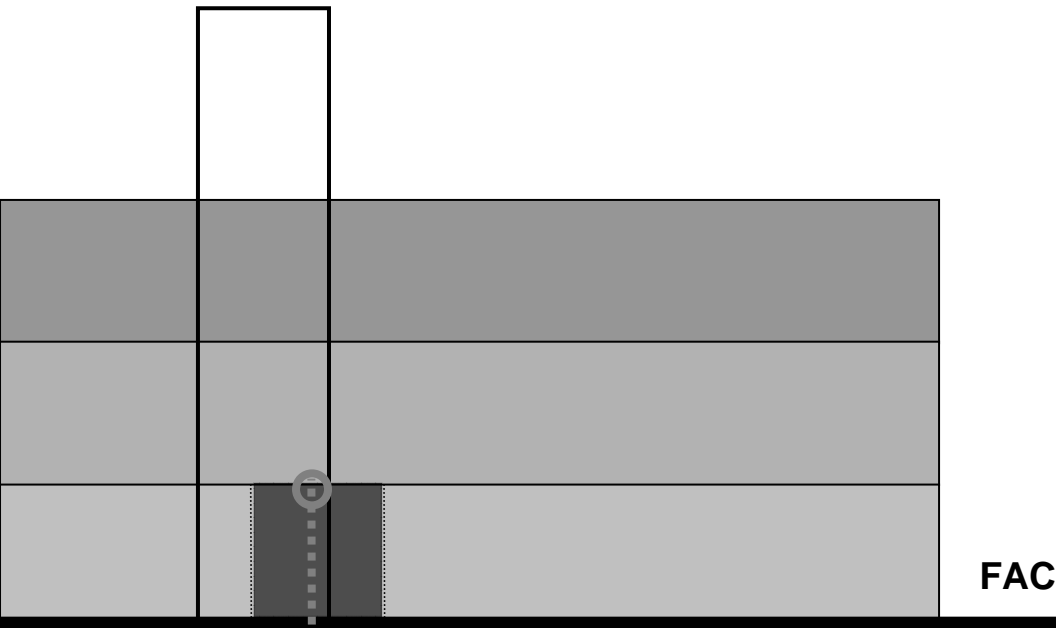

FACHADA

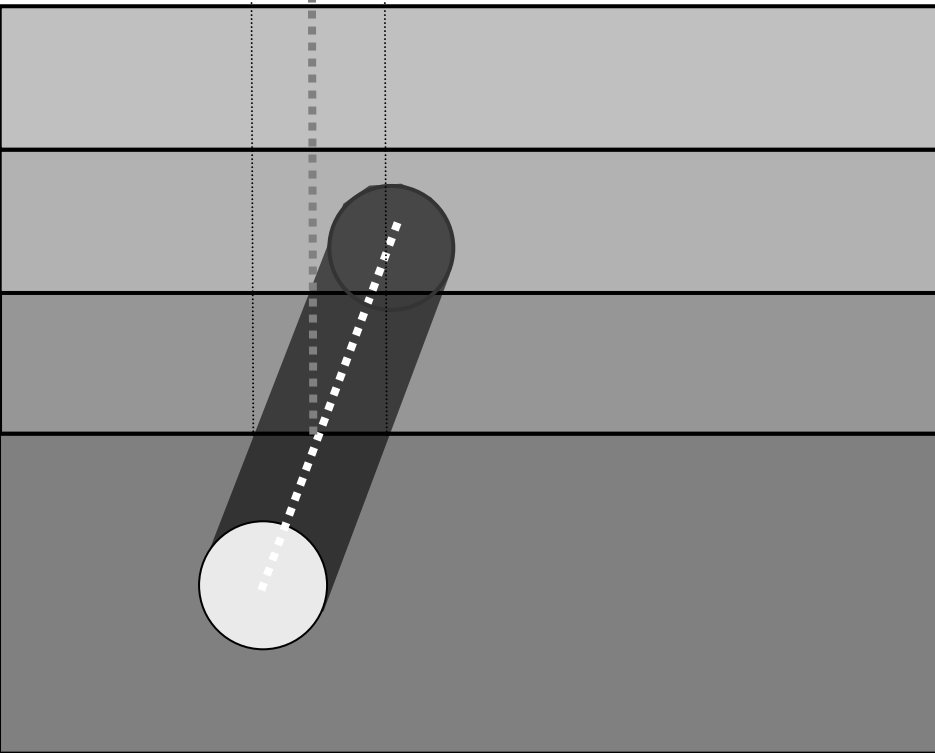

PLANTA

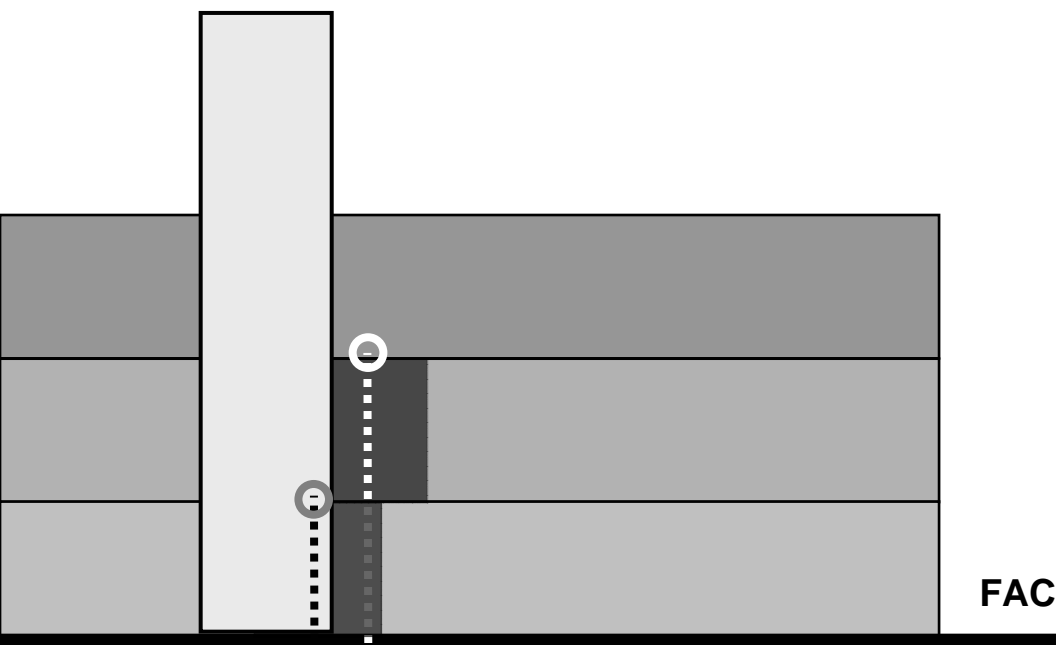

FACHADA

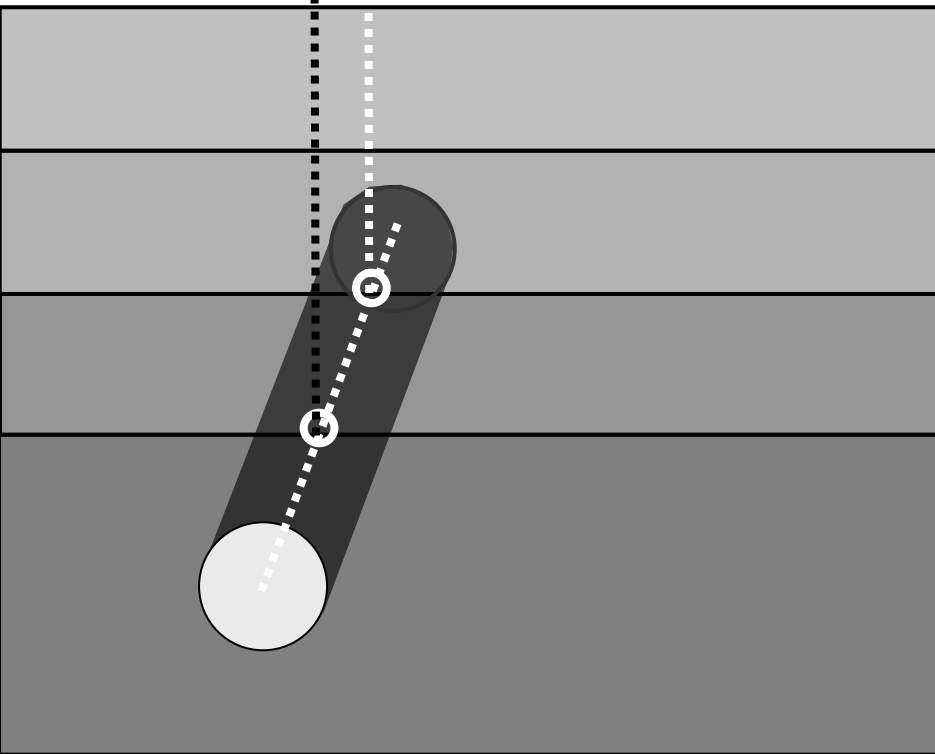

PLANTA

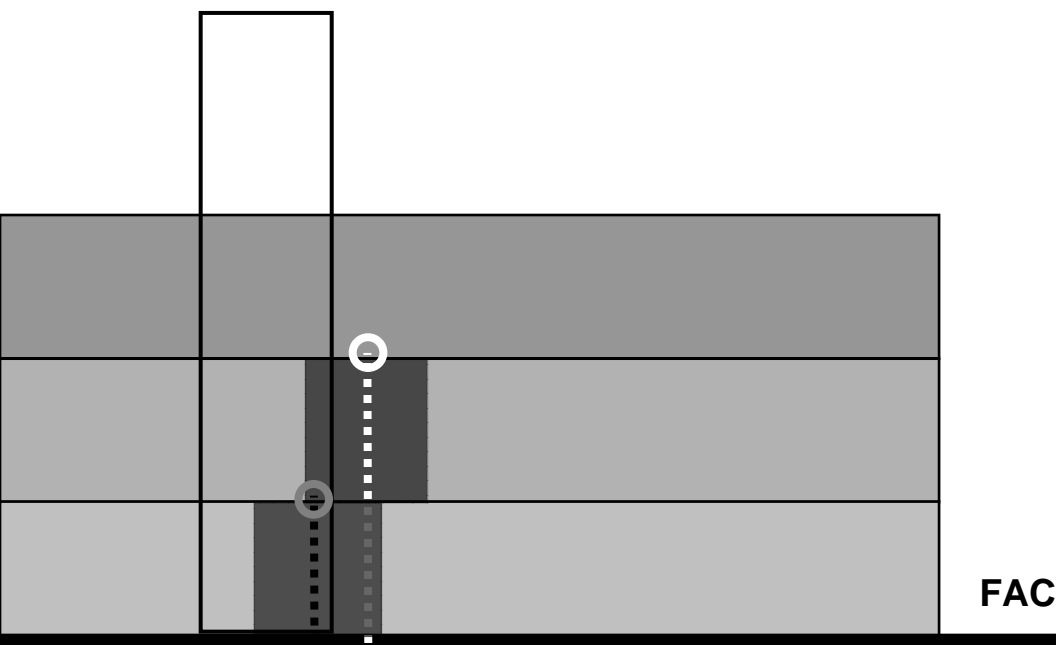

FACHADA

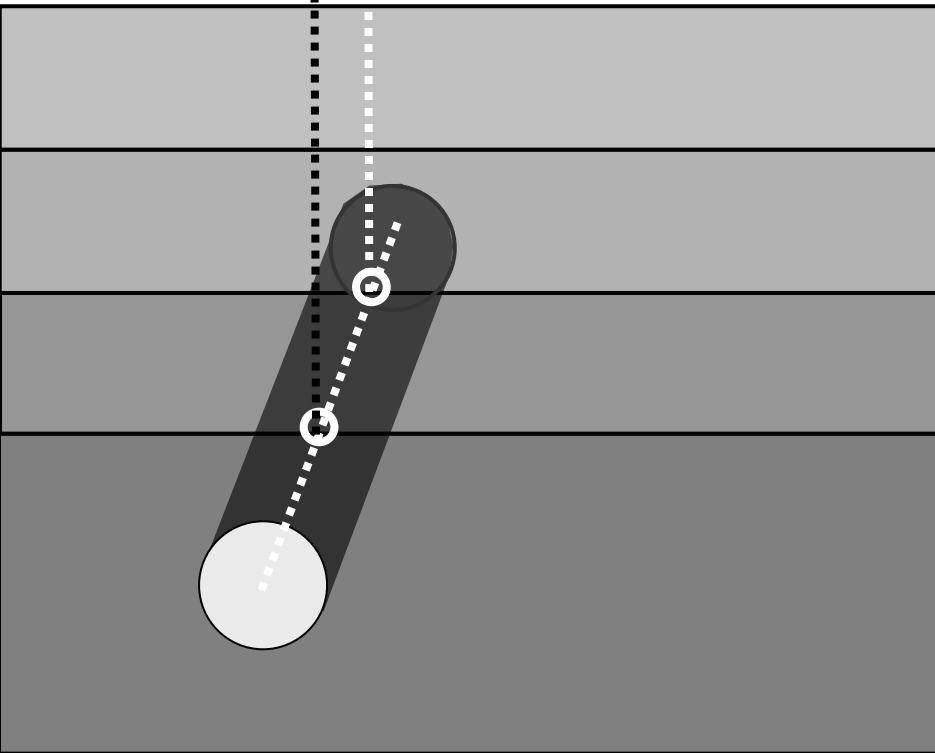

PLANTA

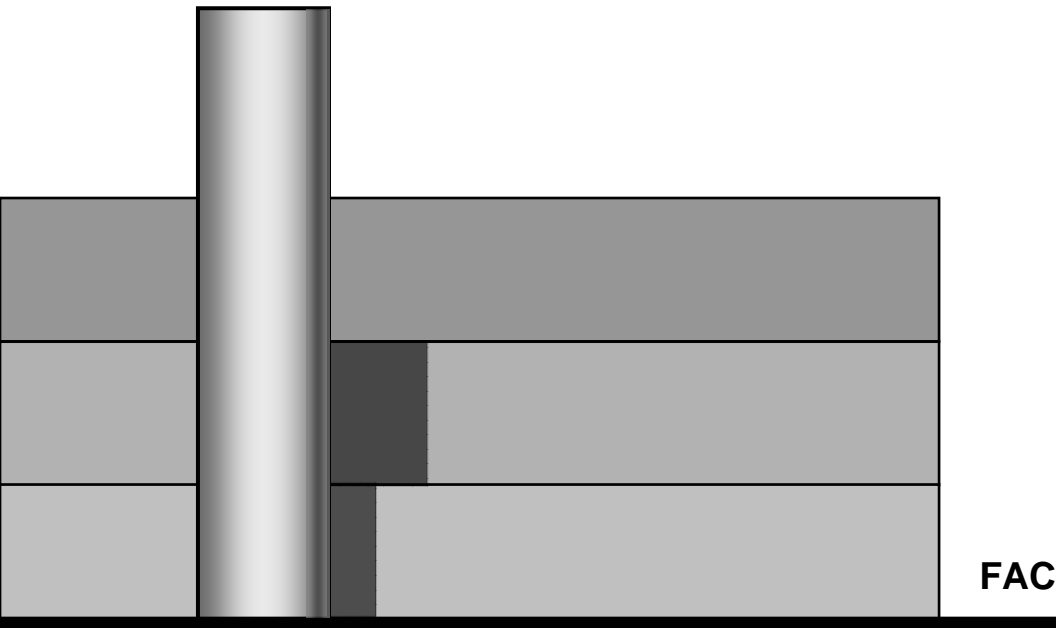

FACHADA

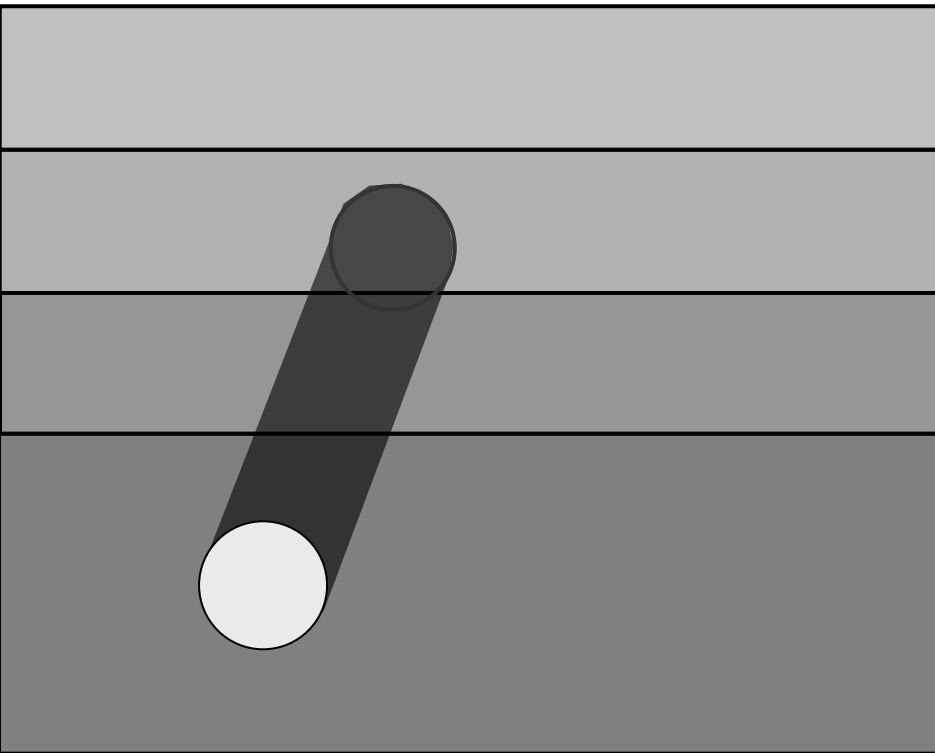

PLANTA

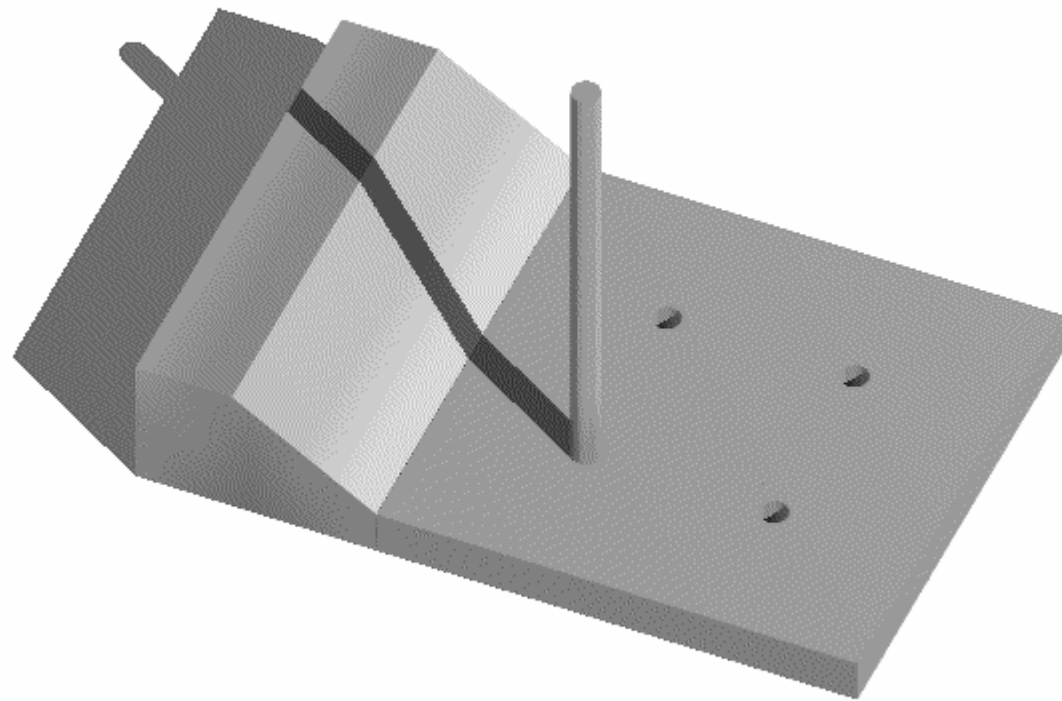

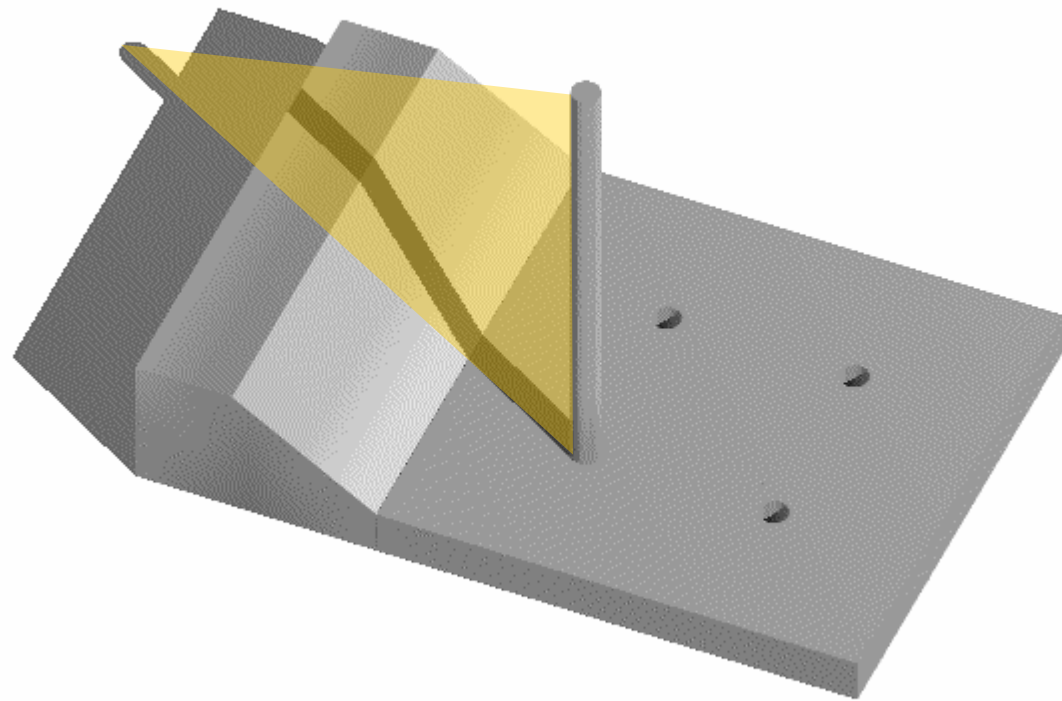

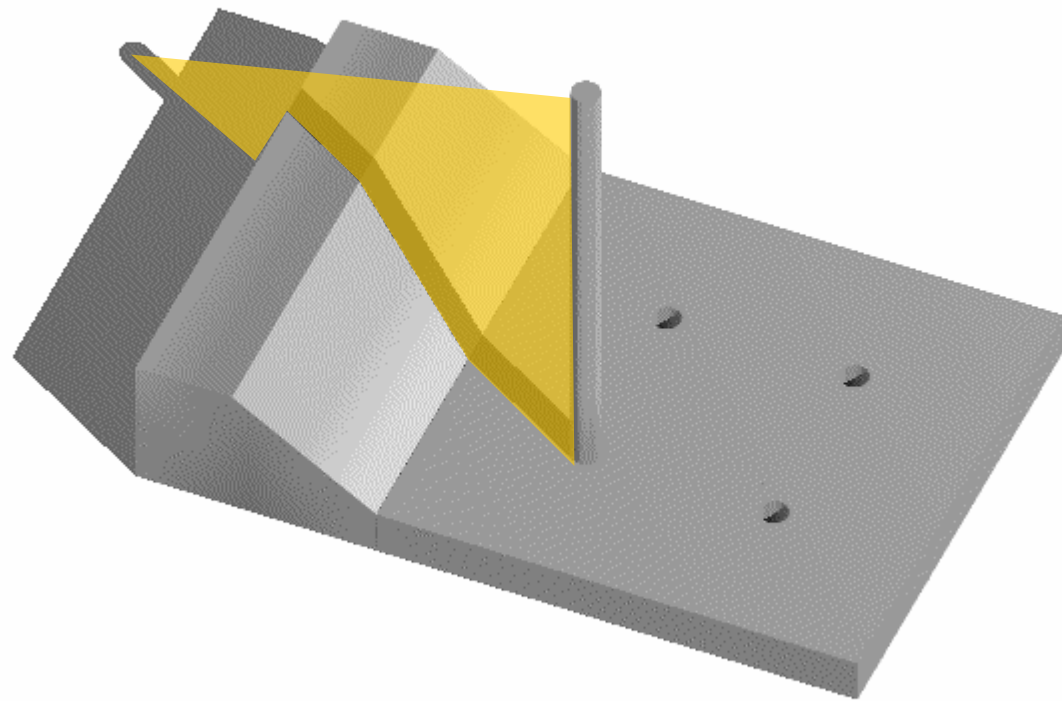

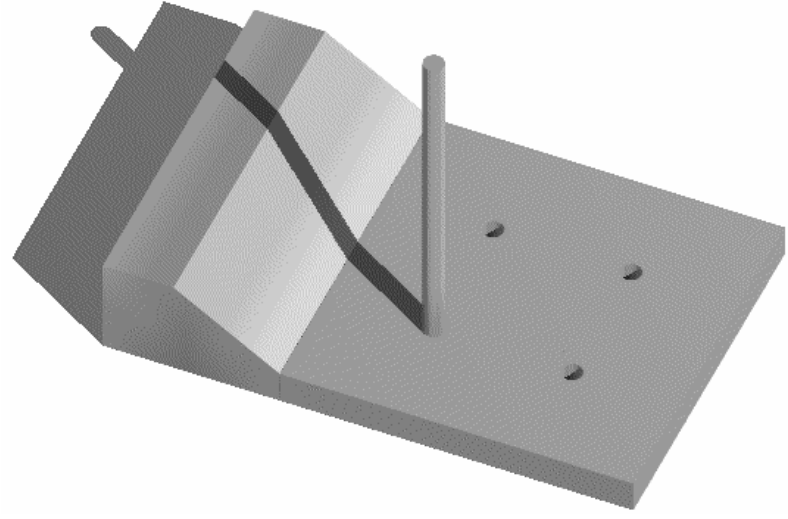
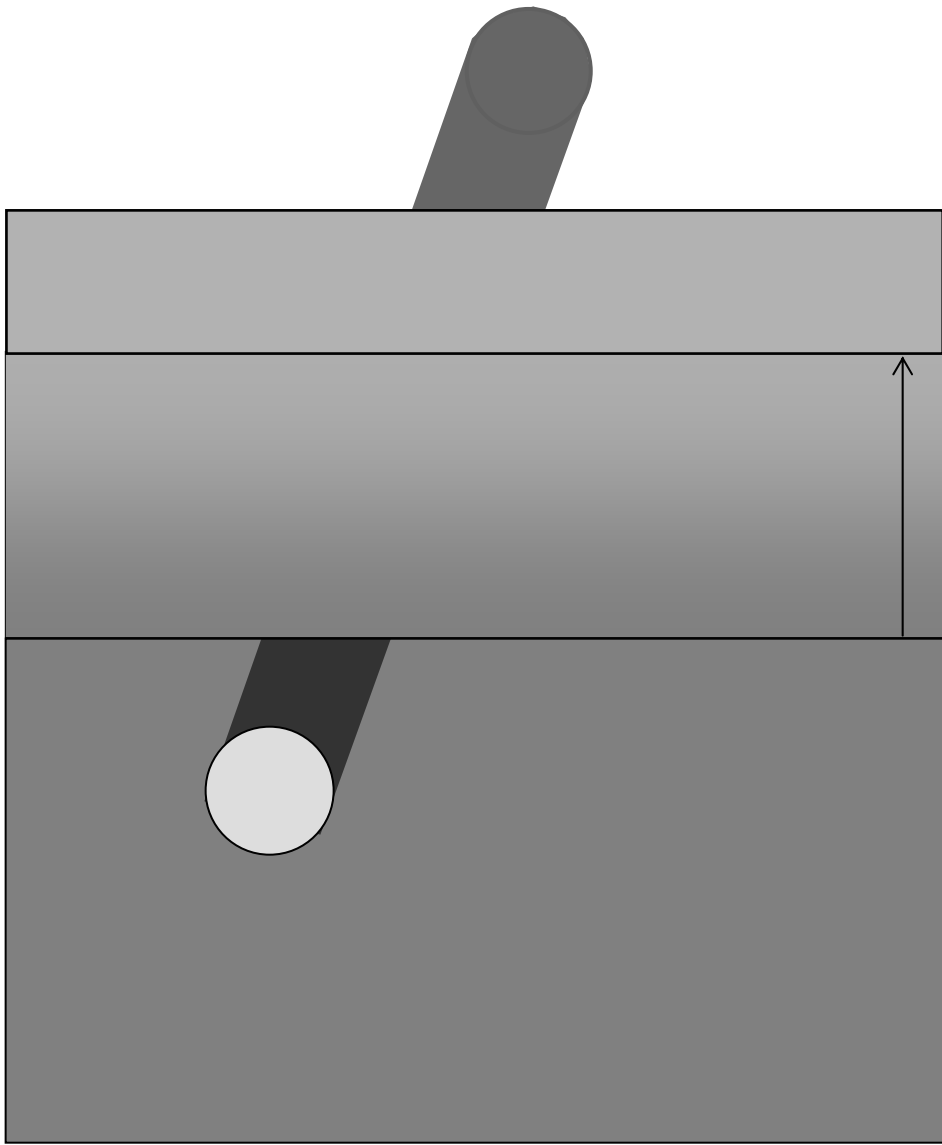

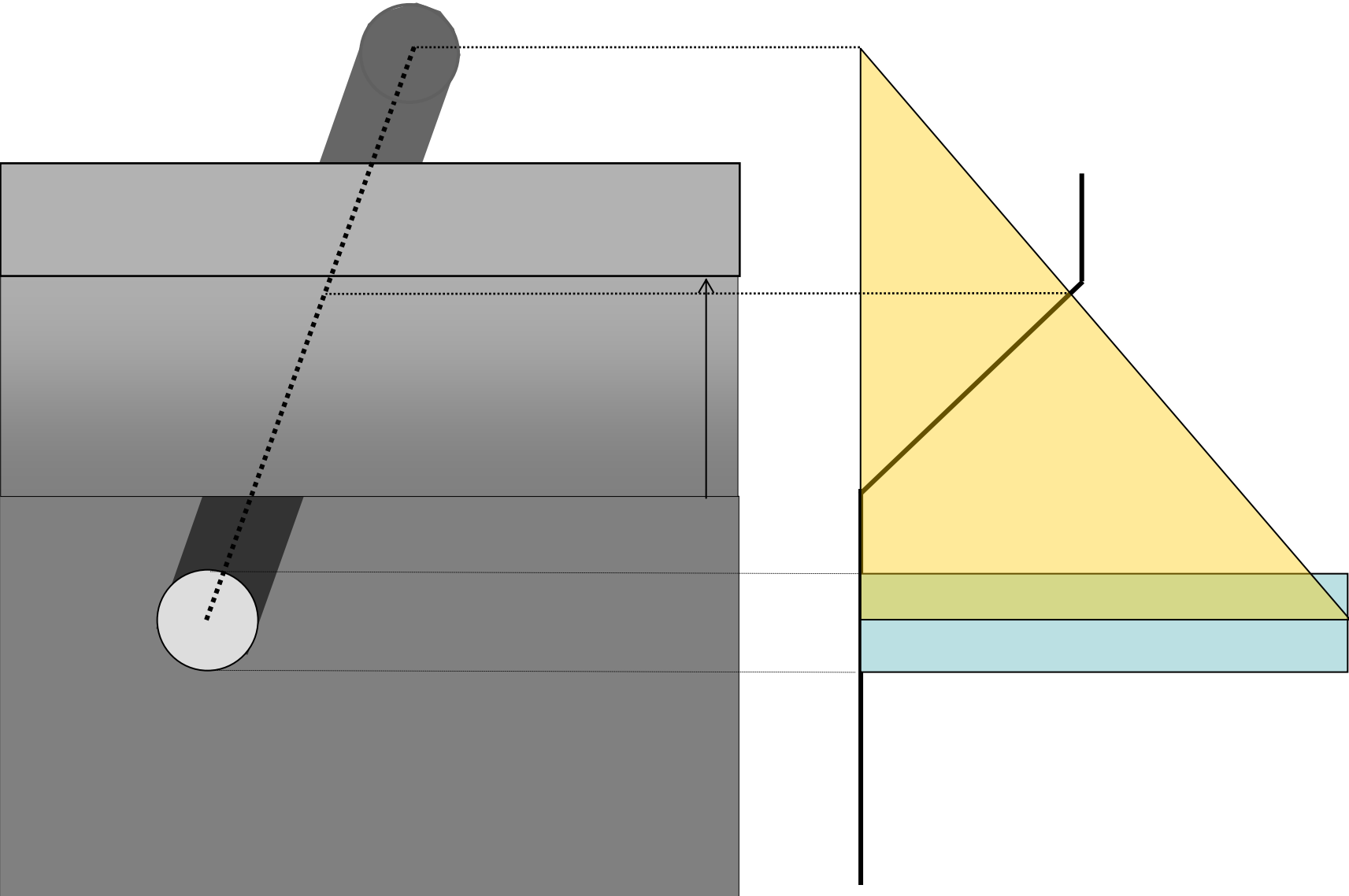

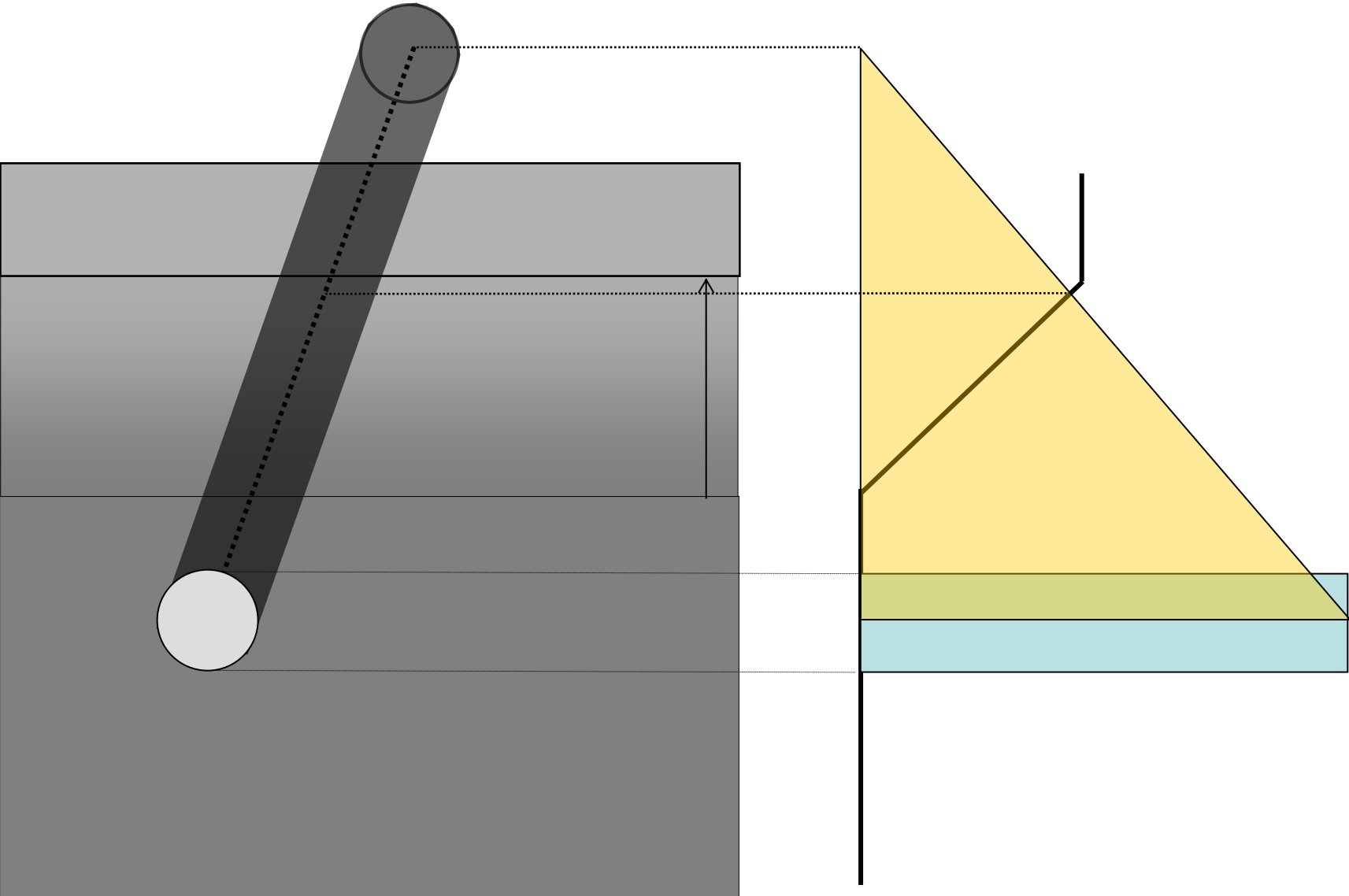

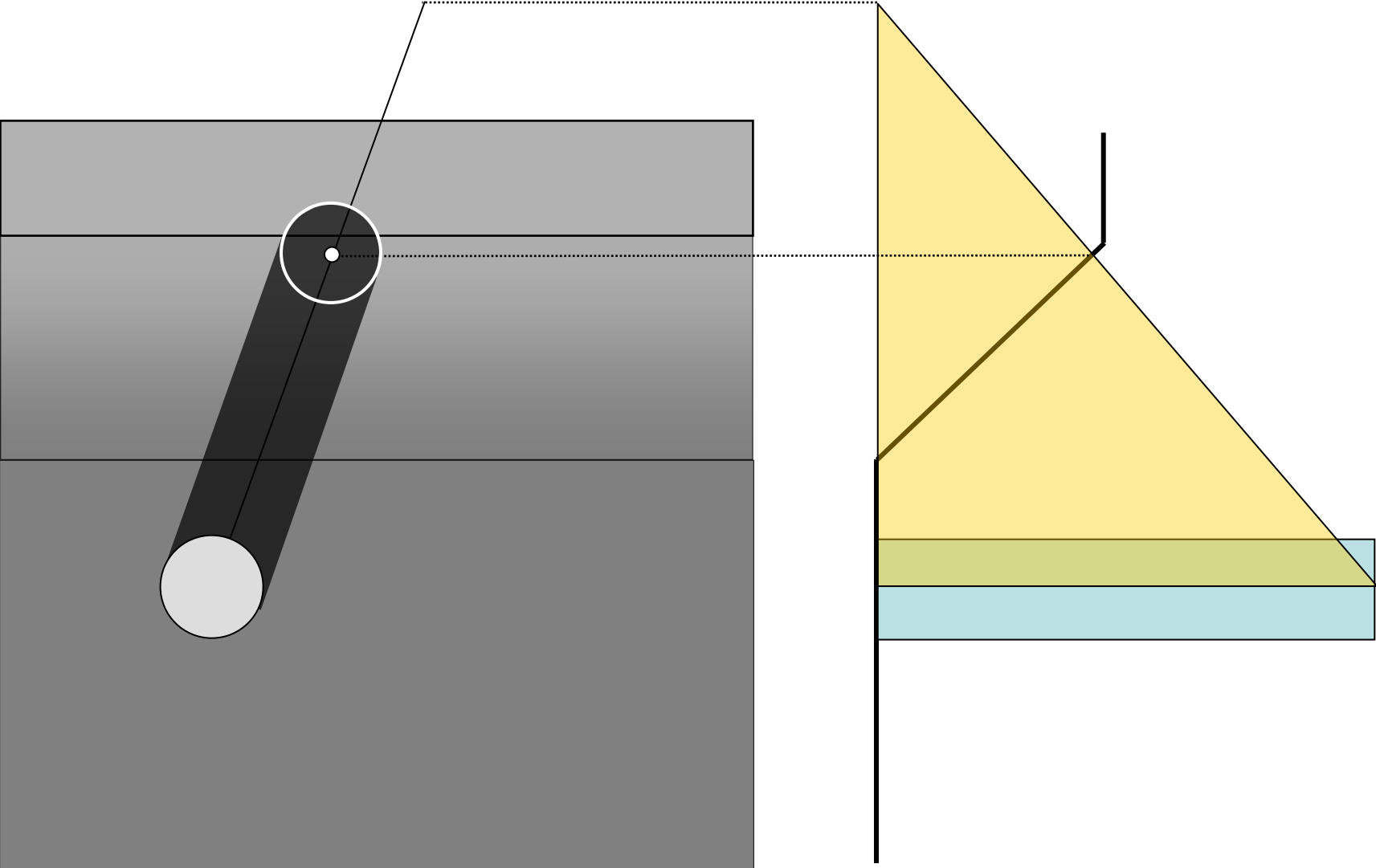

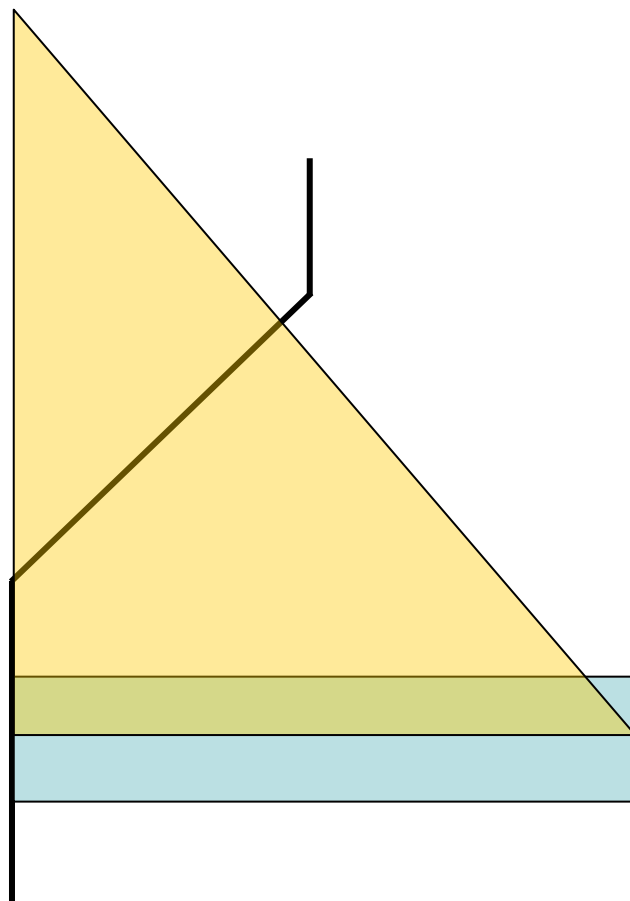
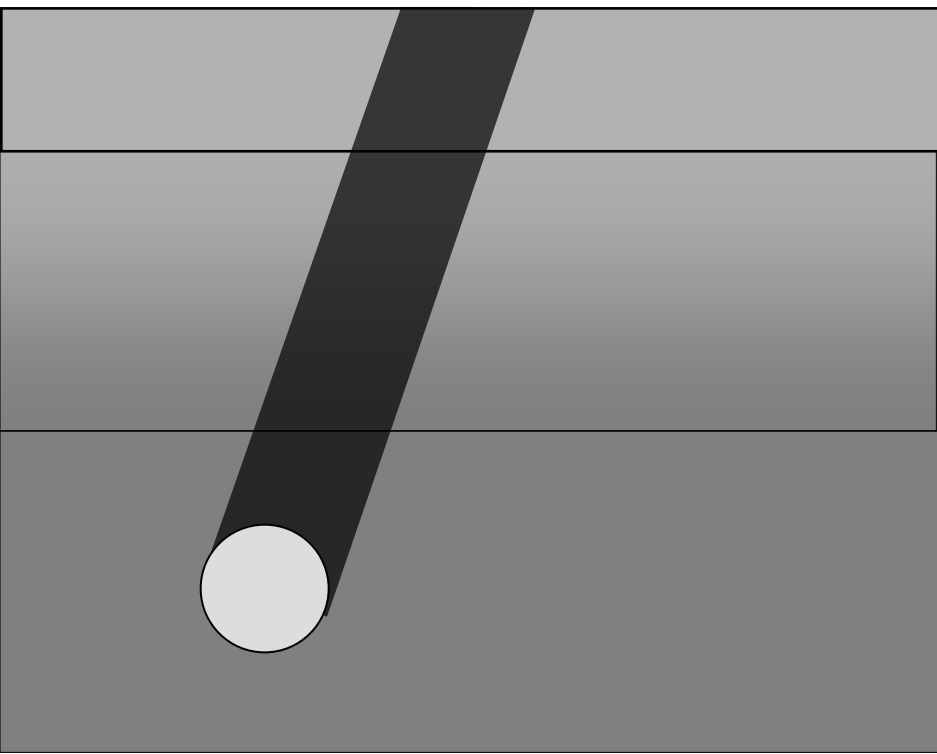
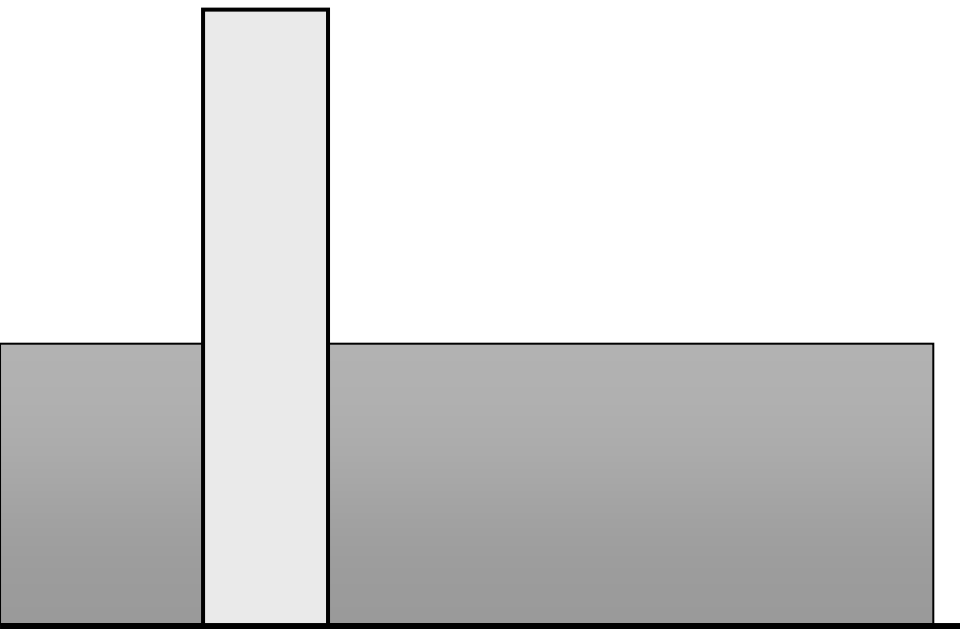

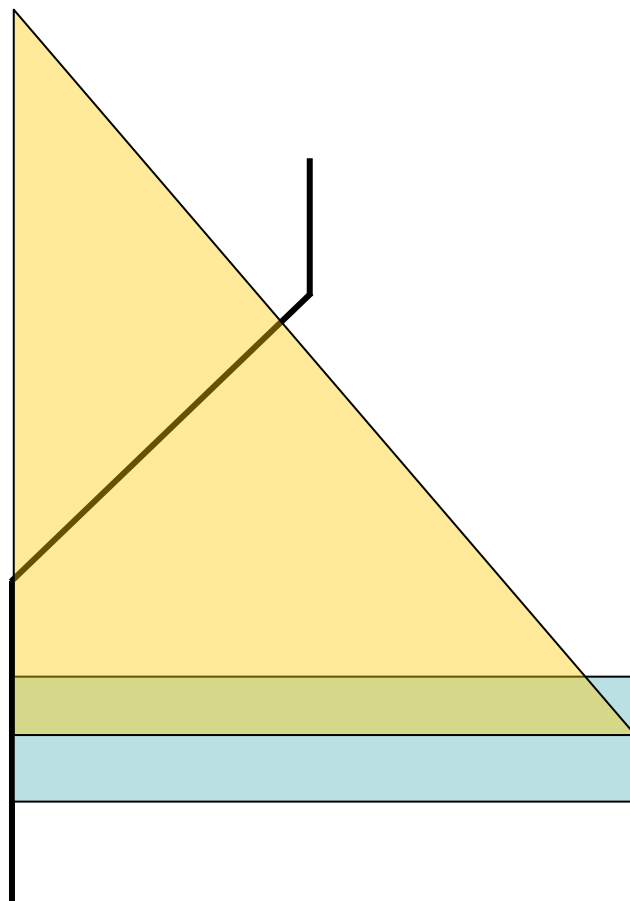
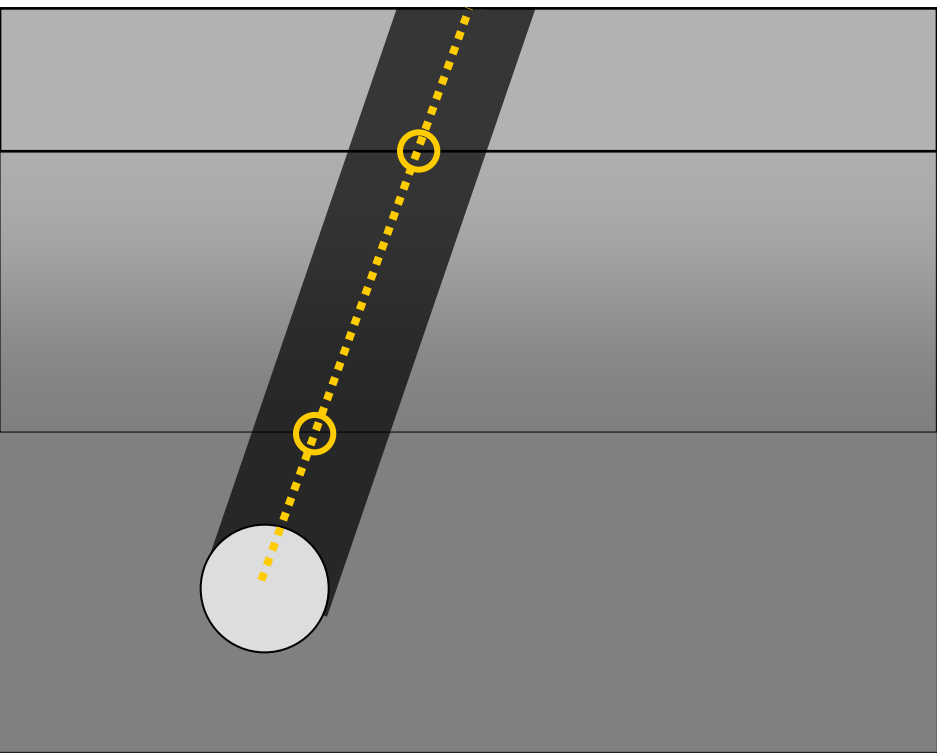
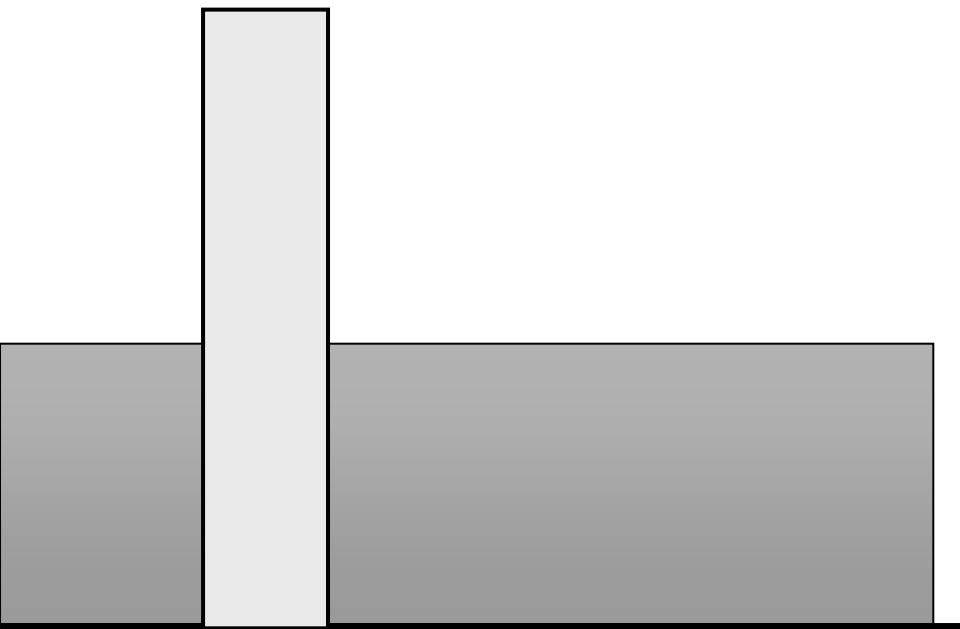

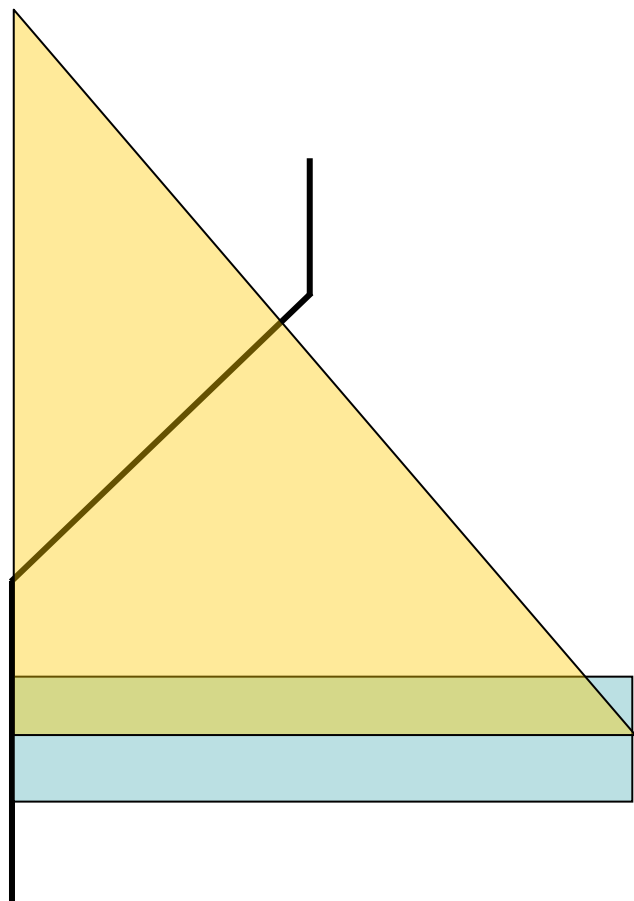
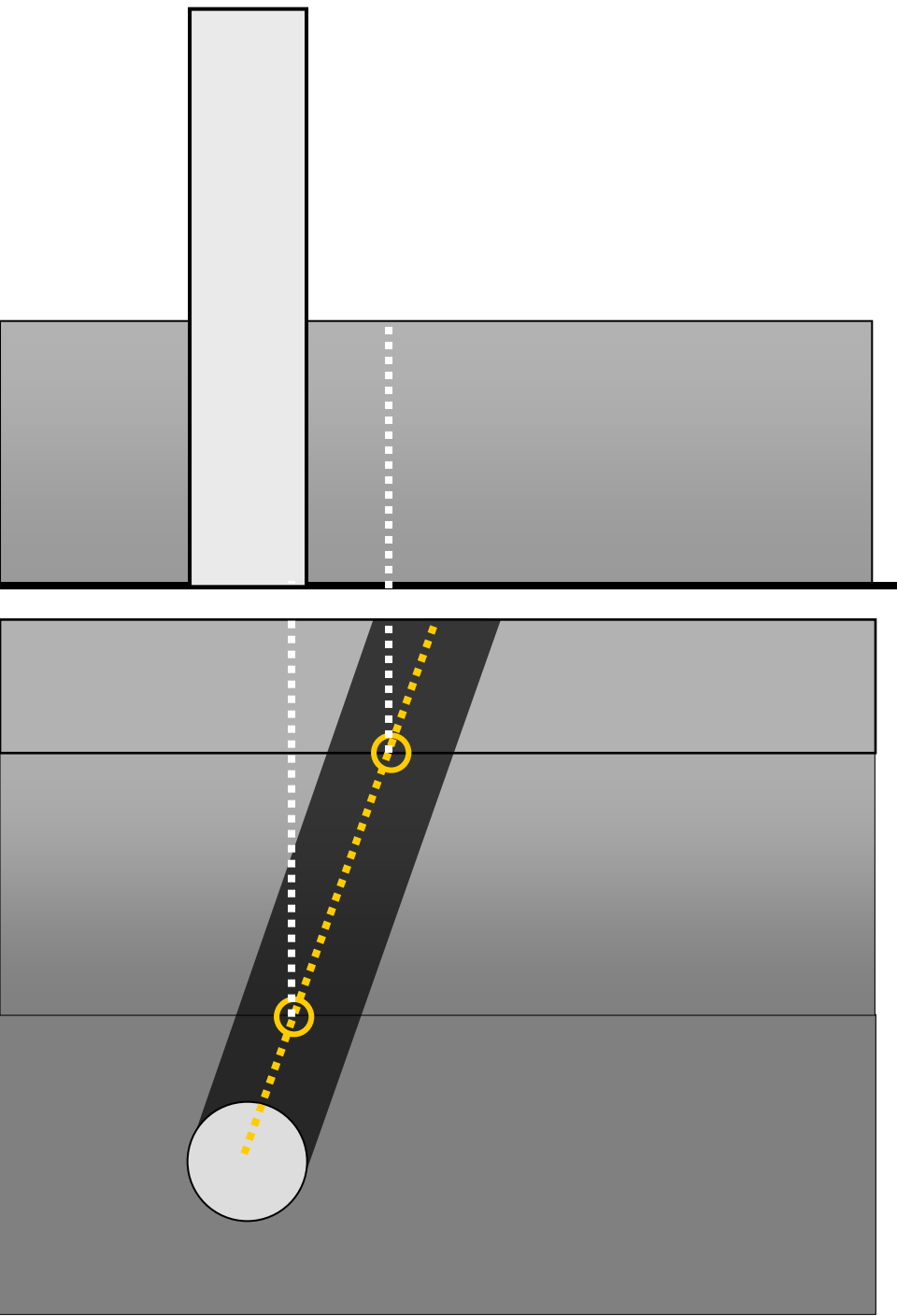

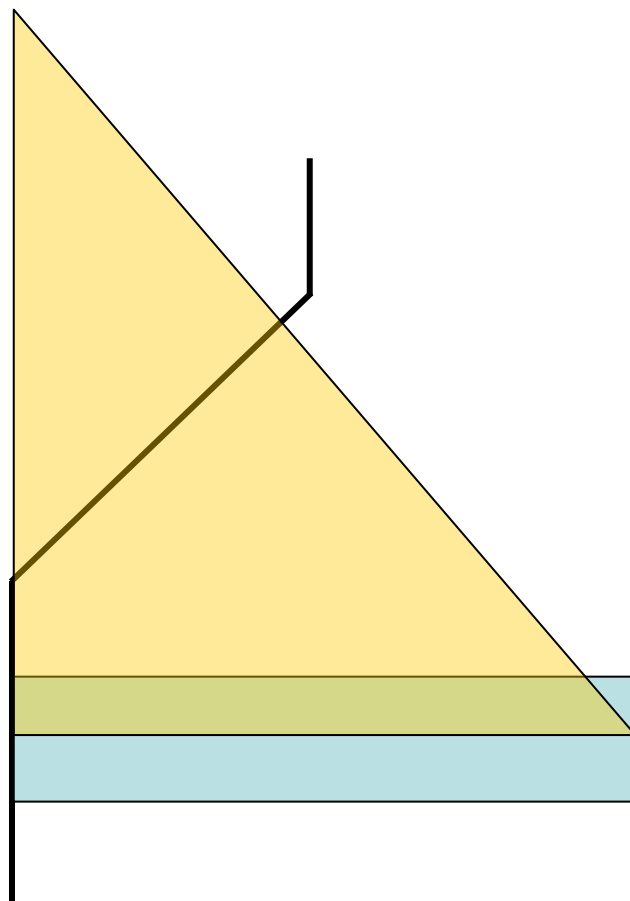
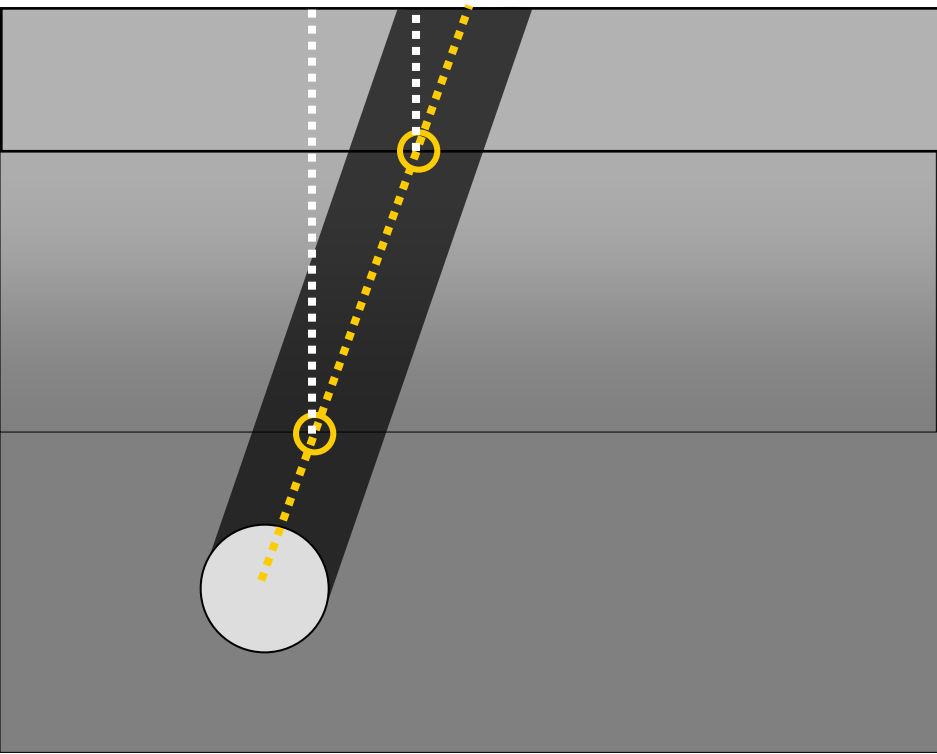
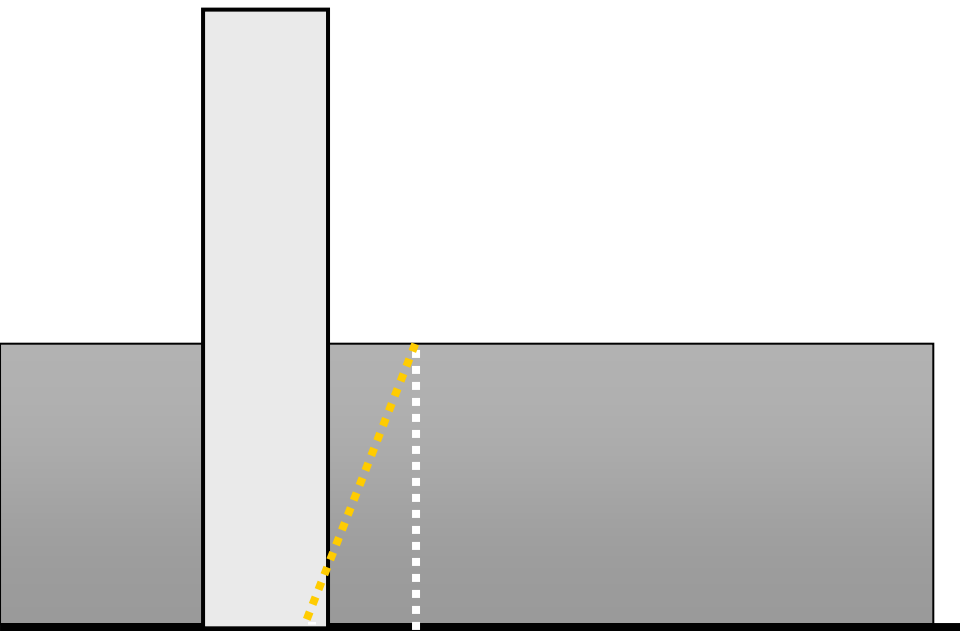

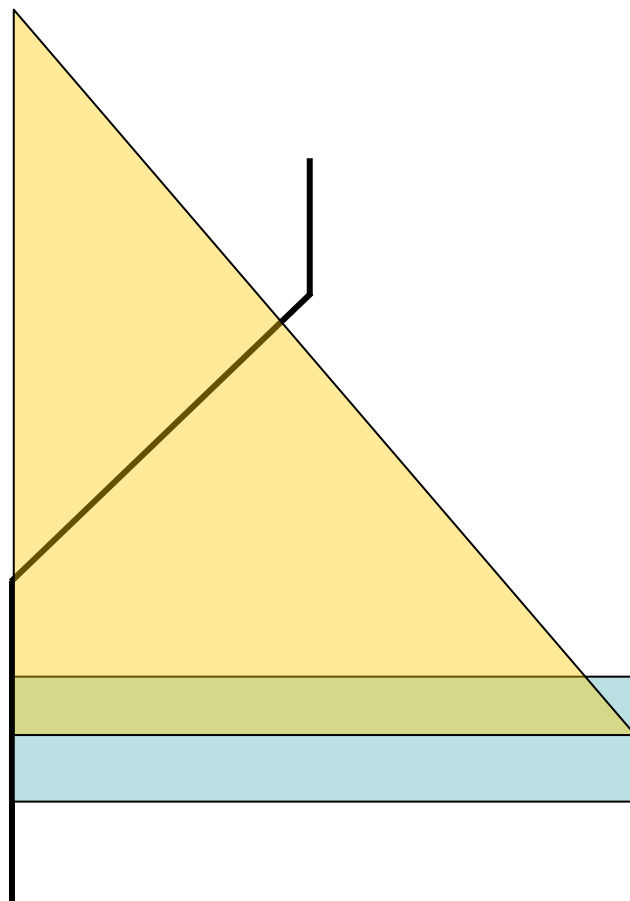
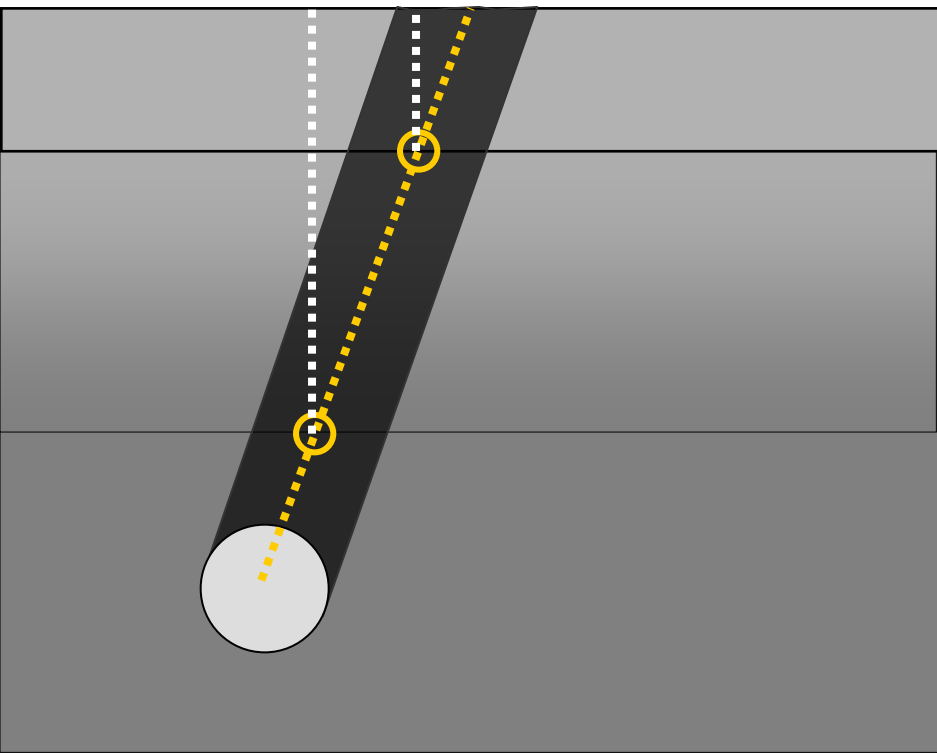
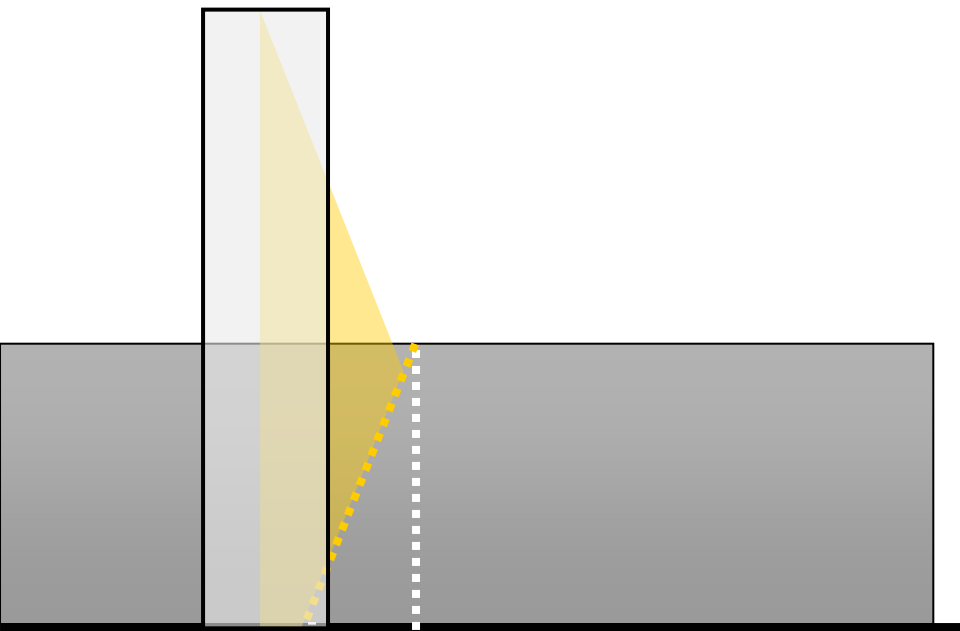

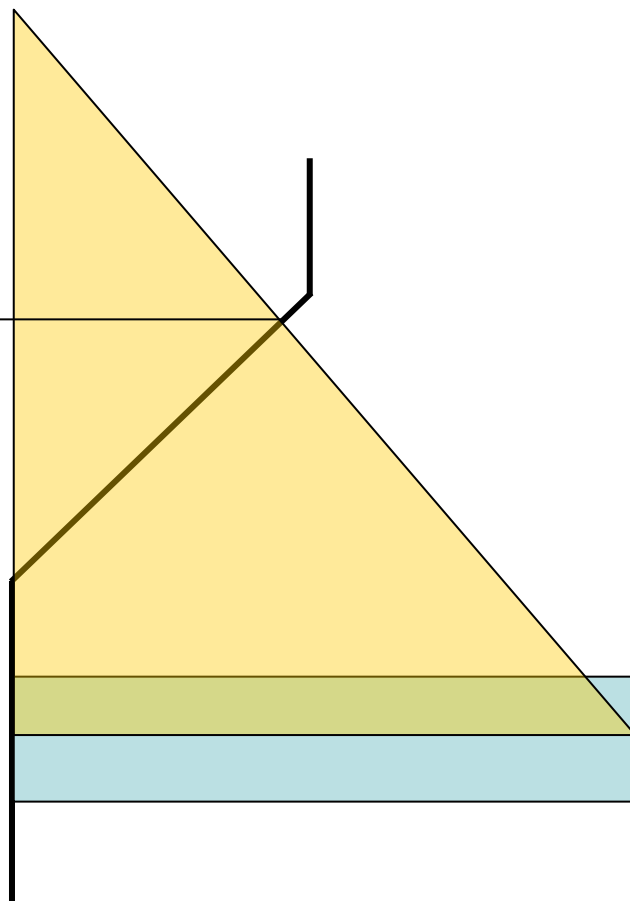
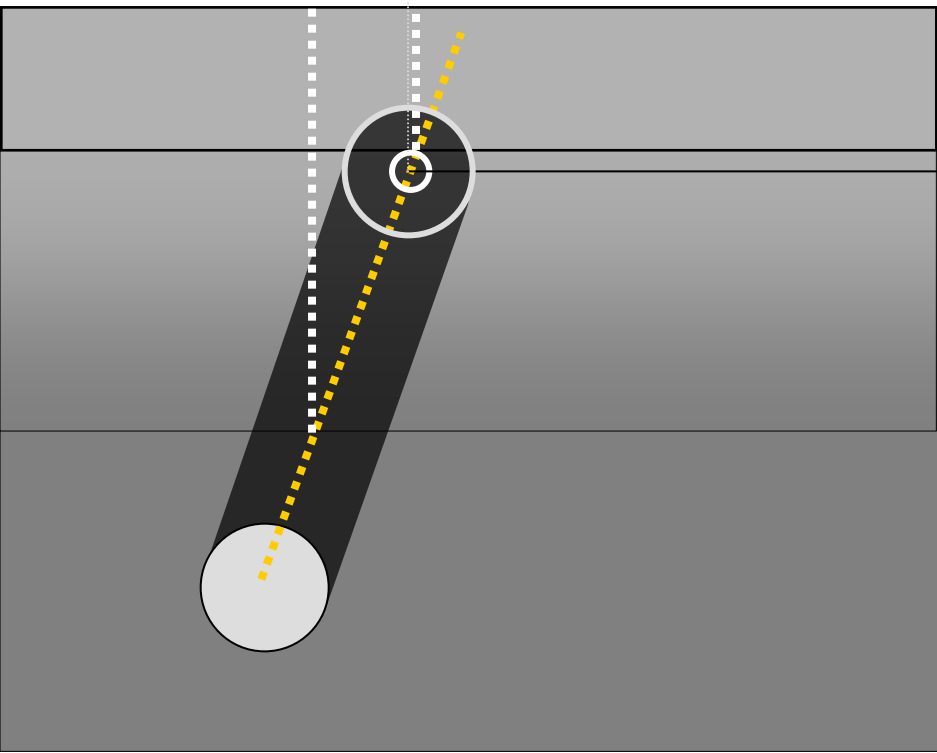
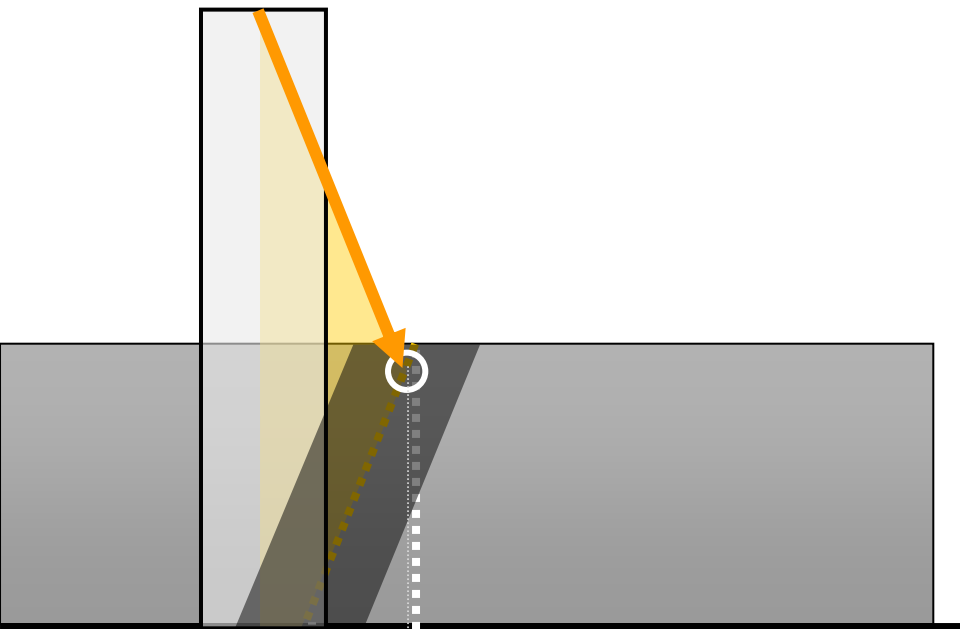

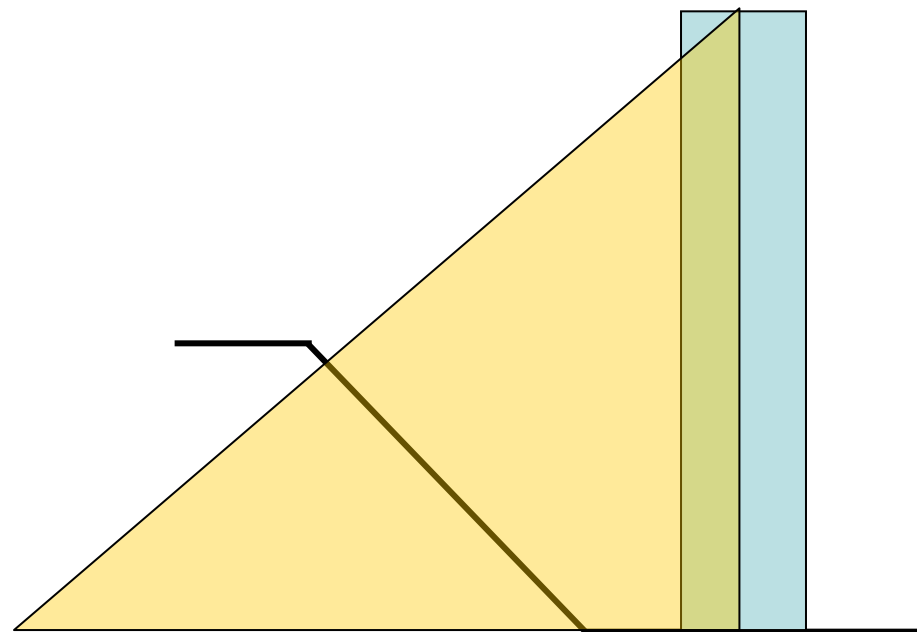
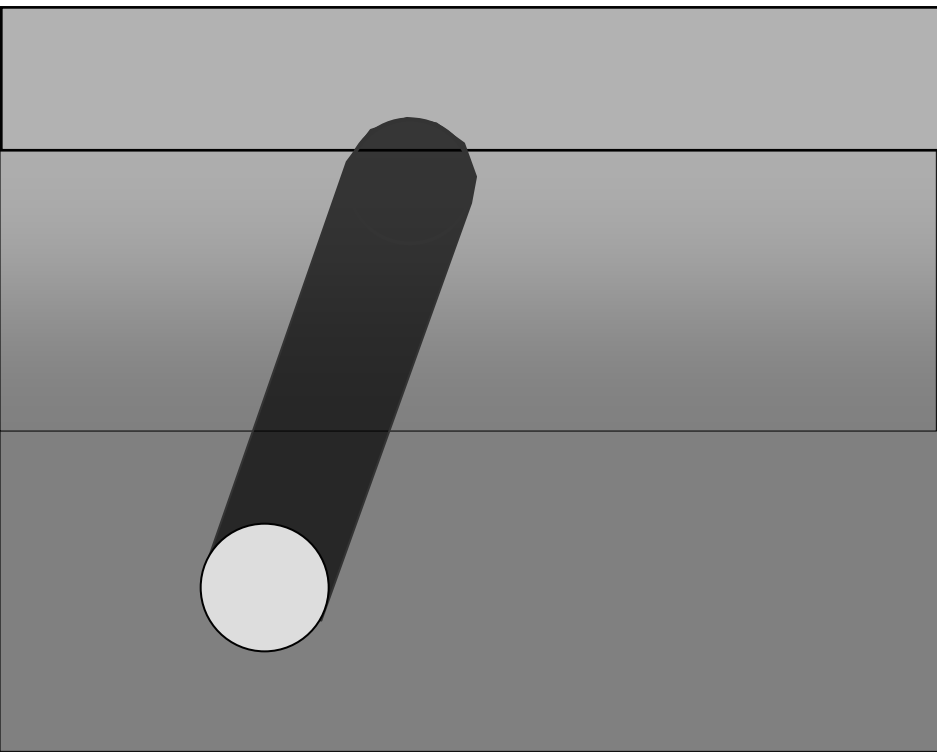
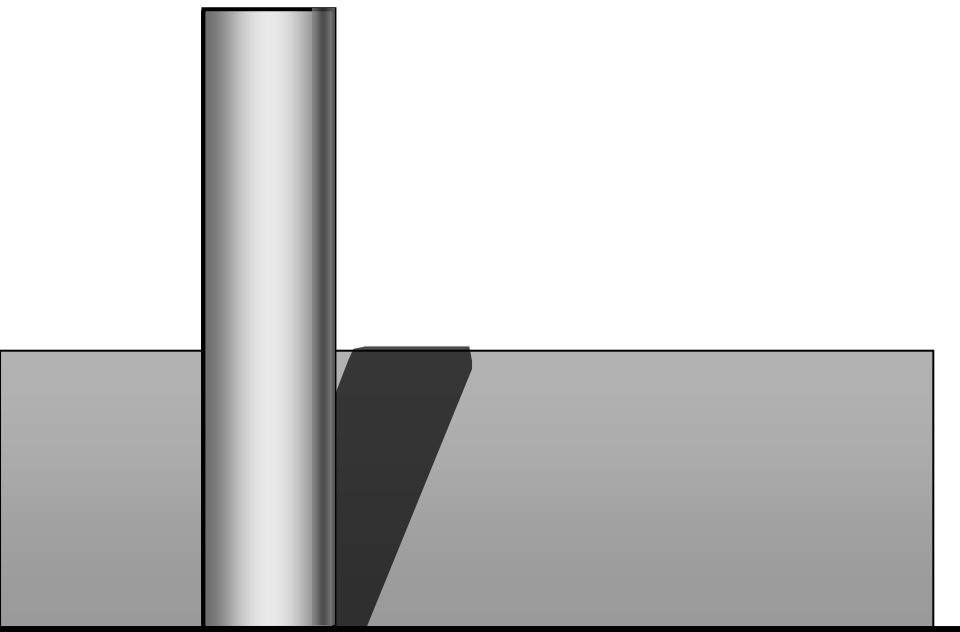

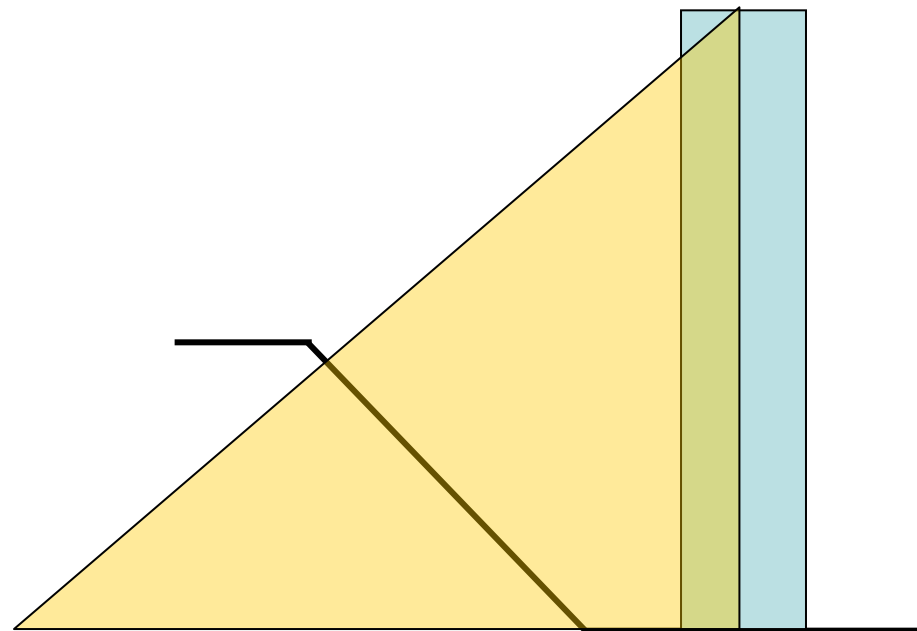
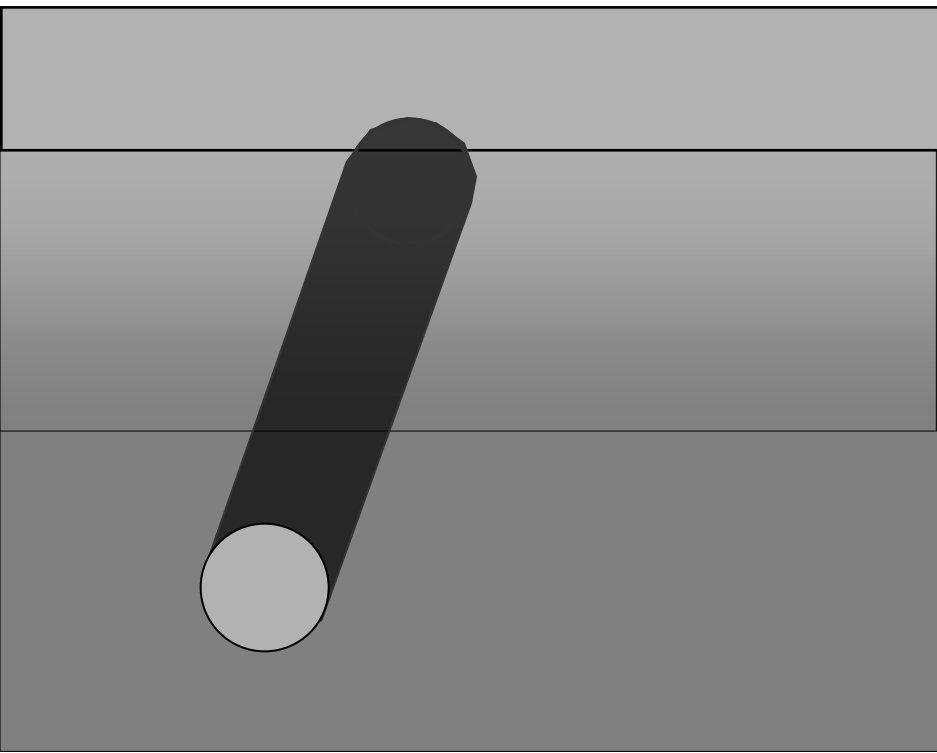
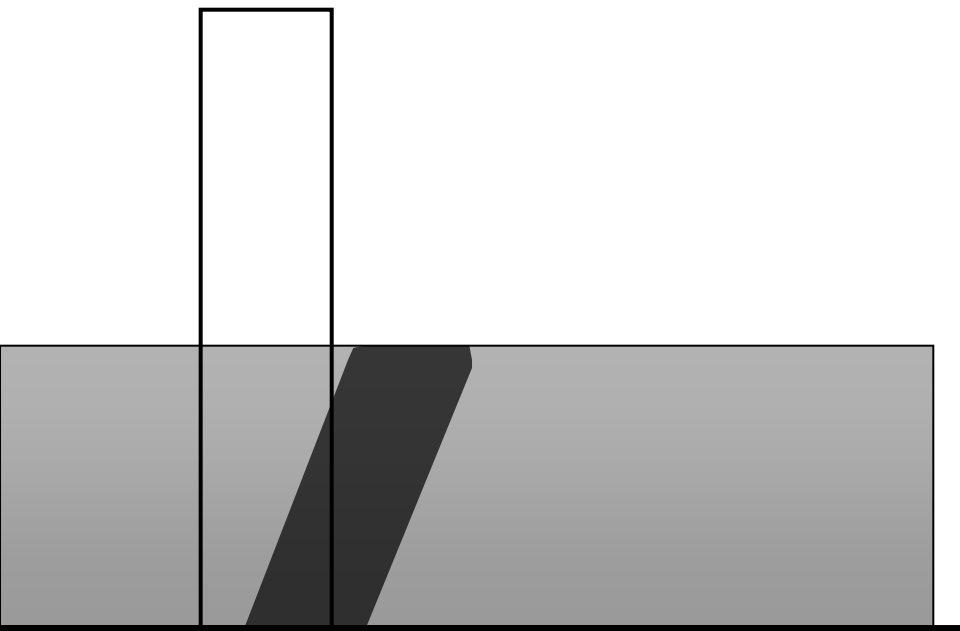

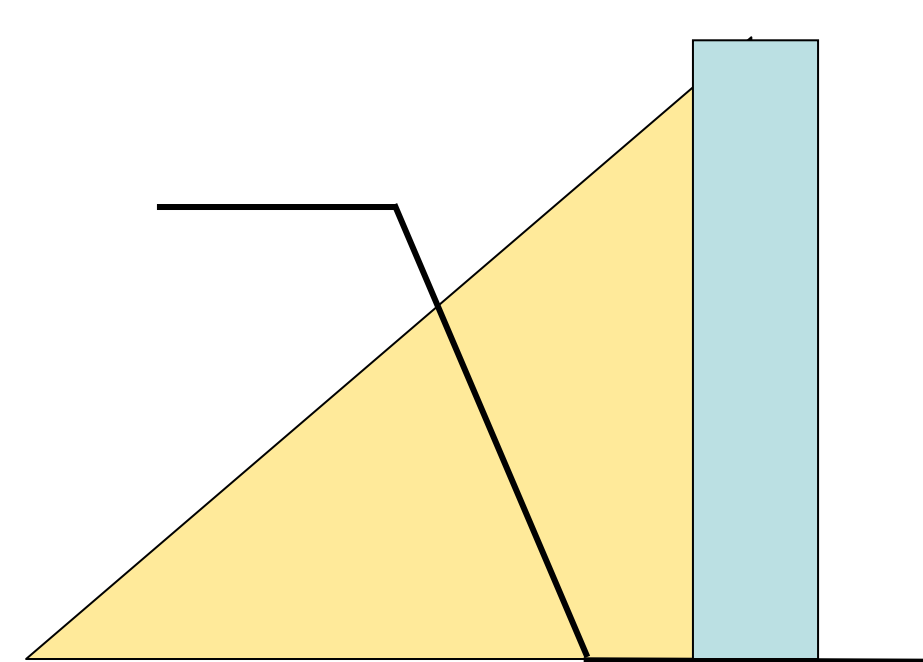
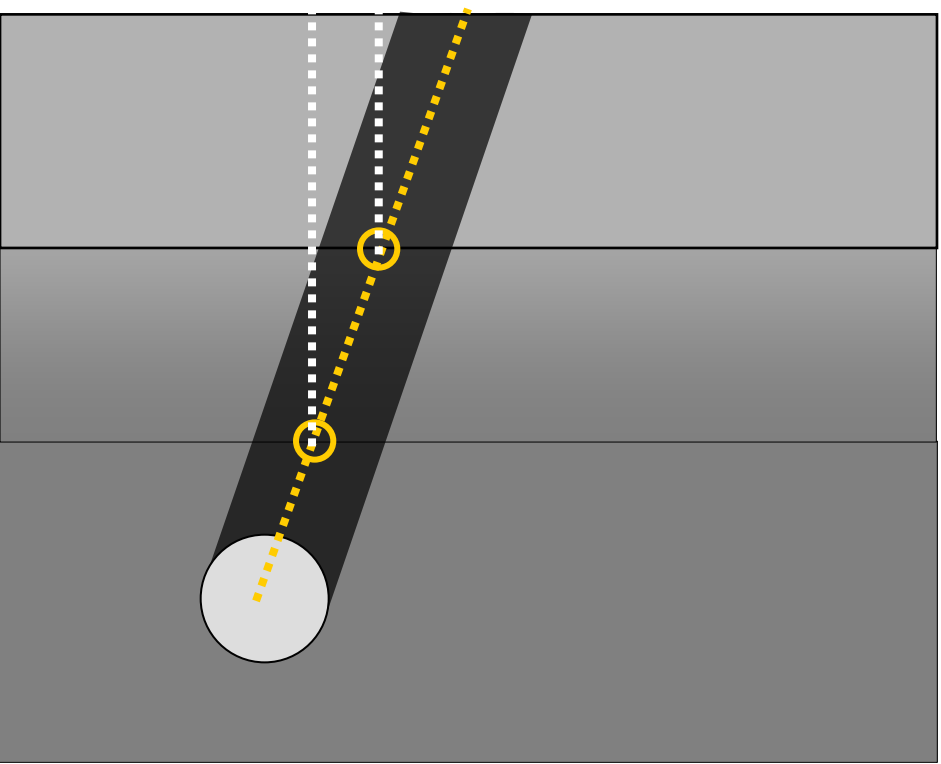
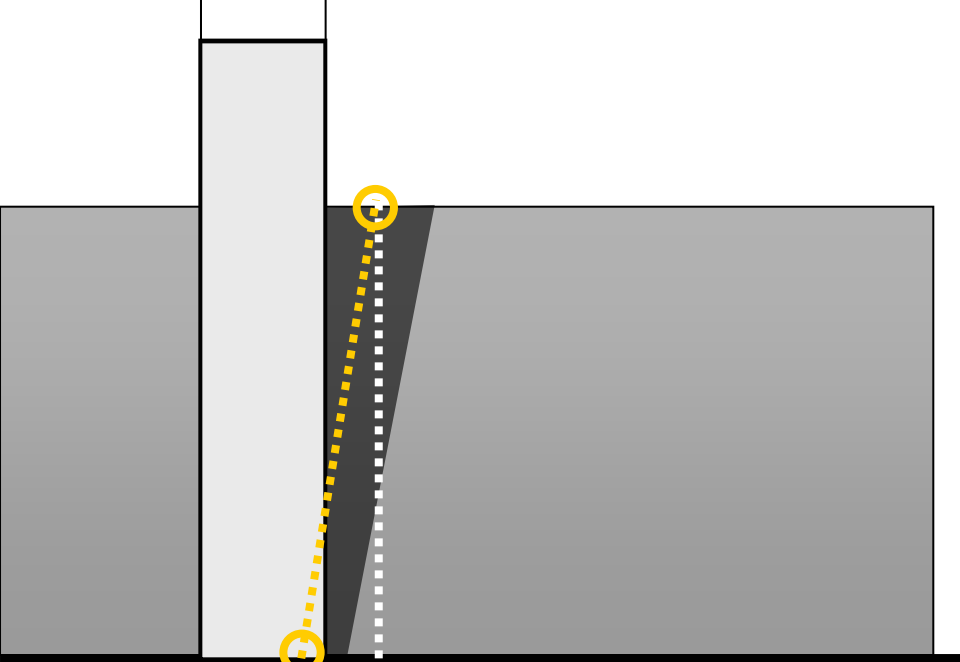

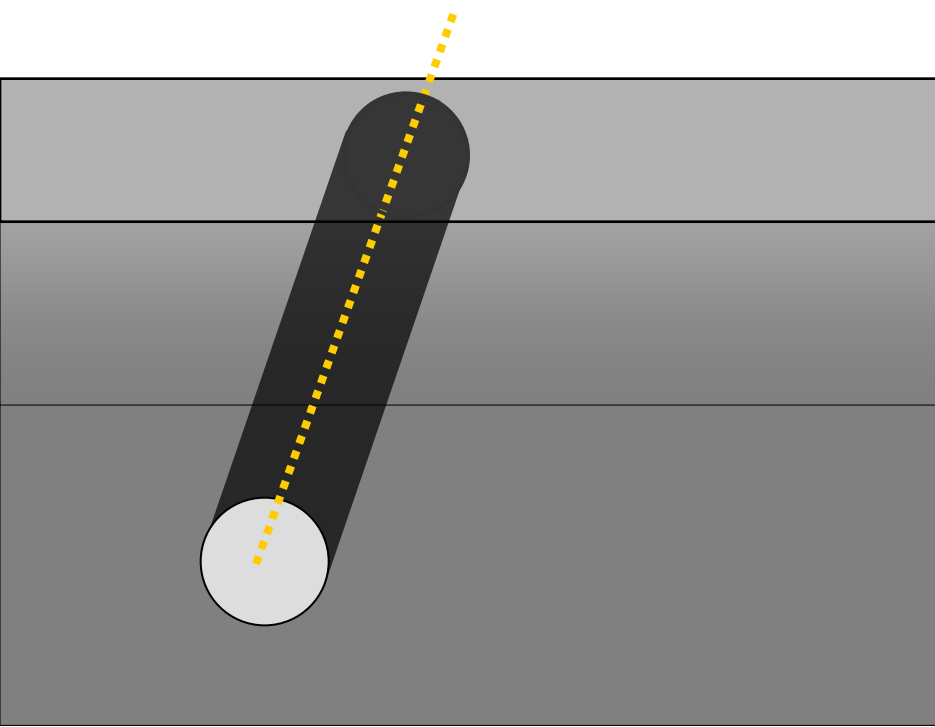
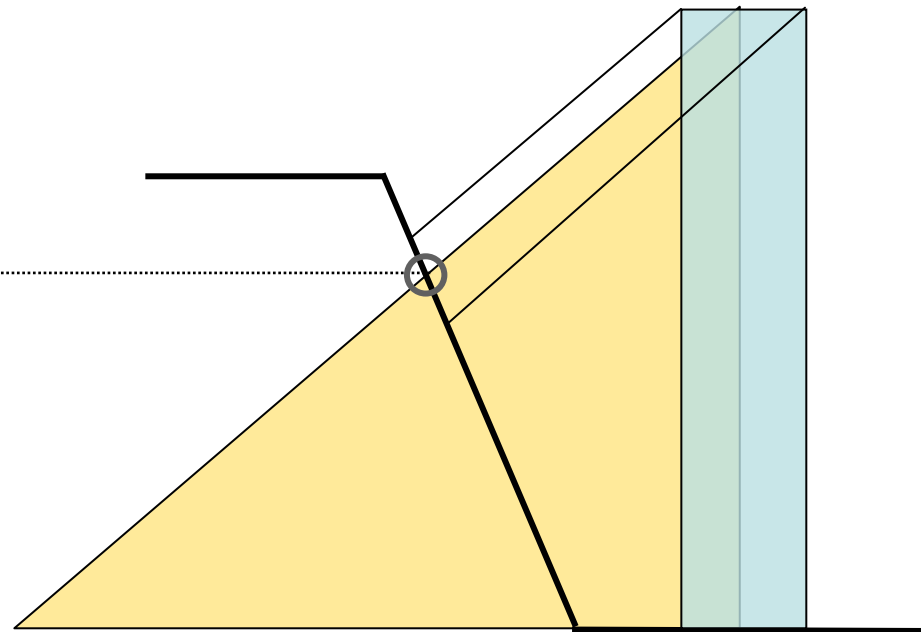
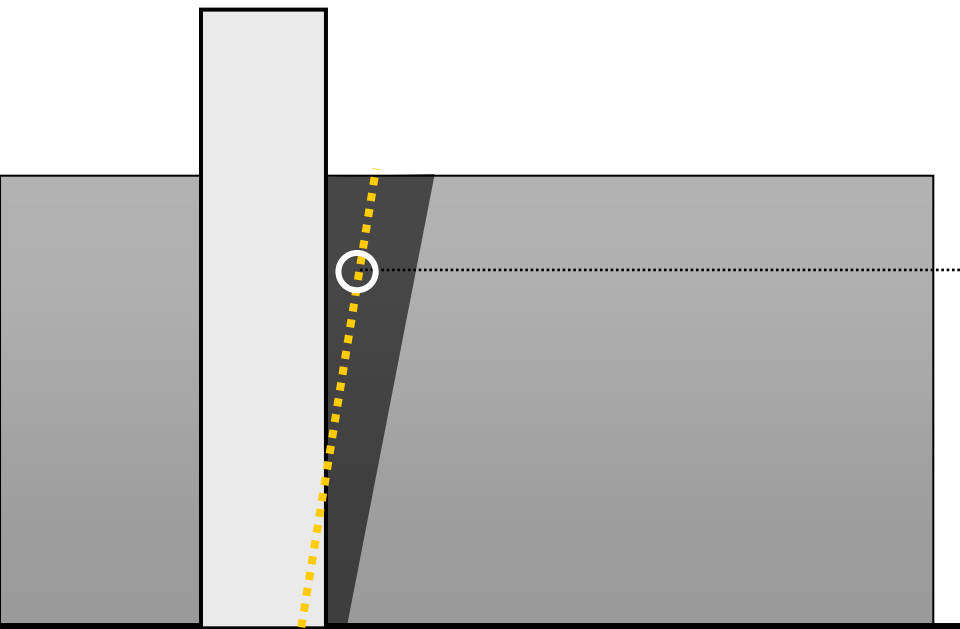

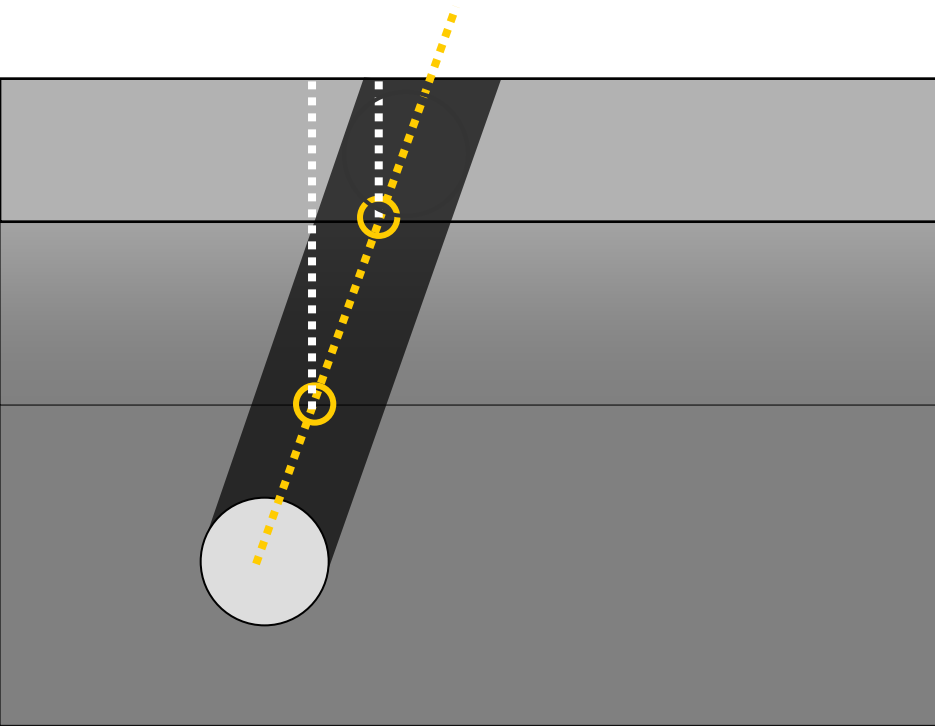
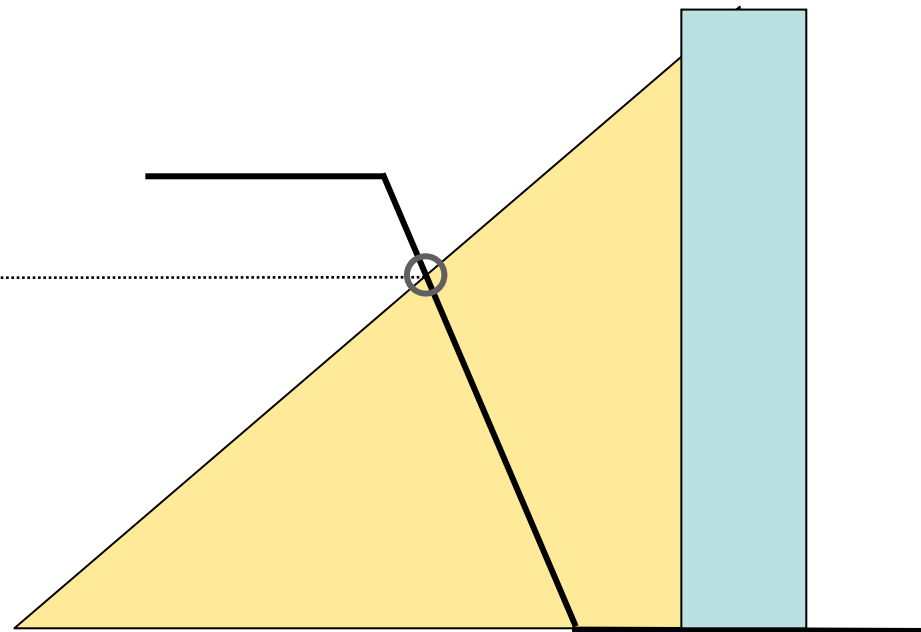
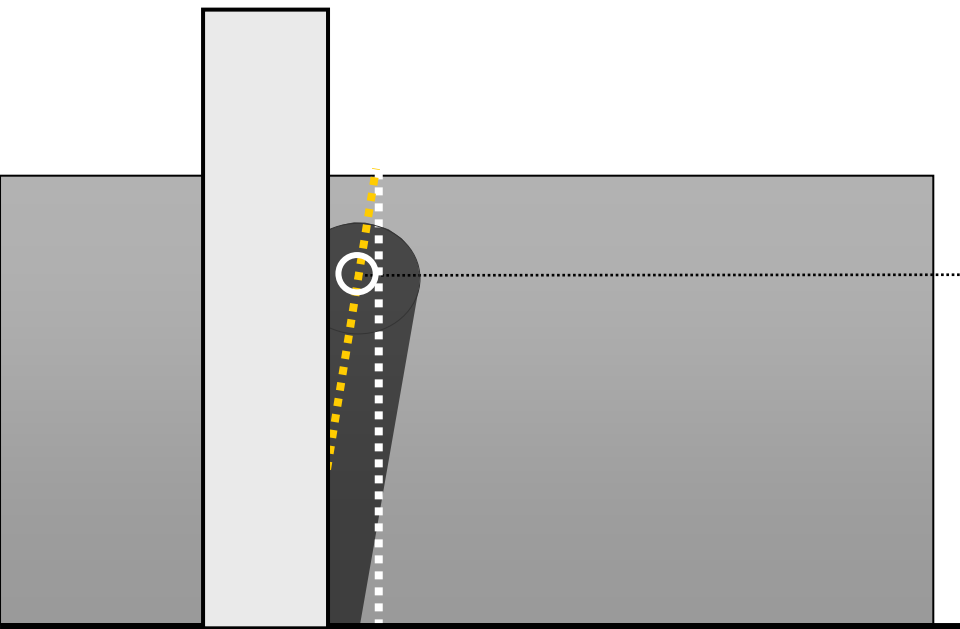

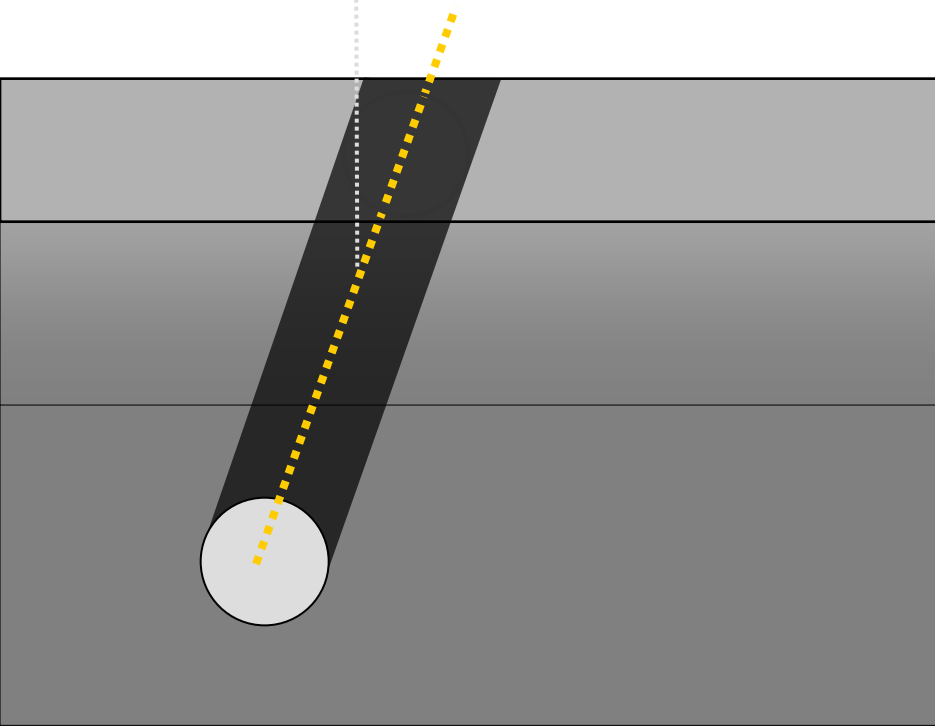
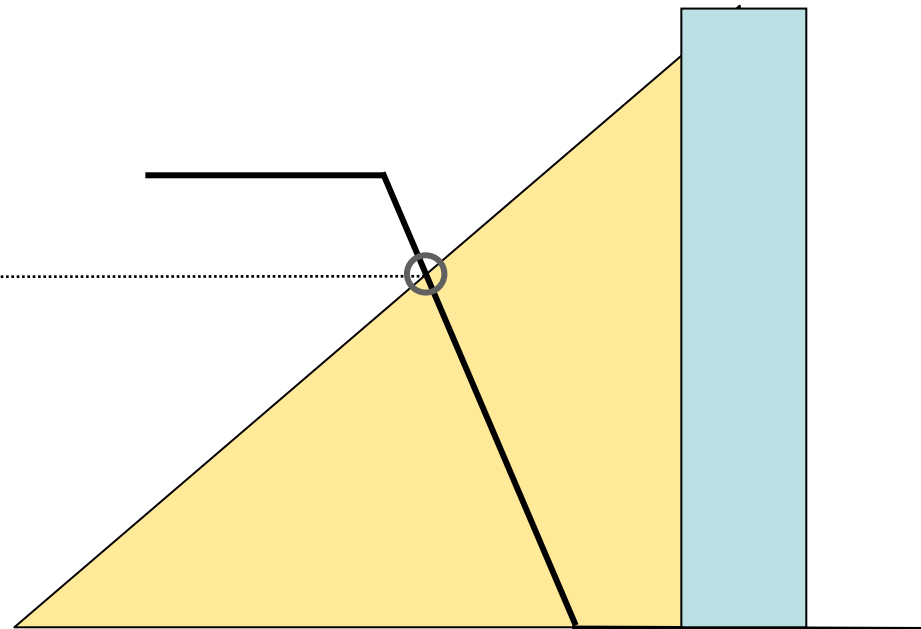
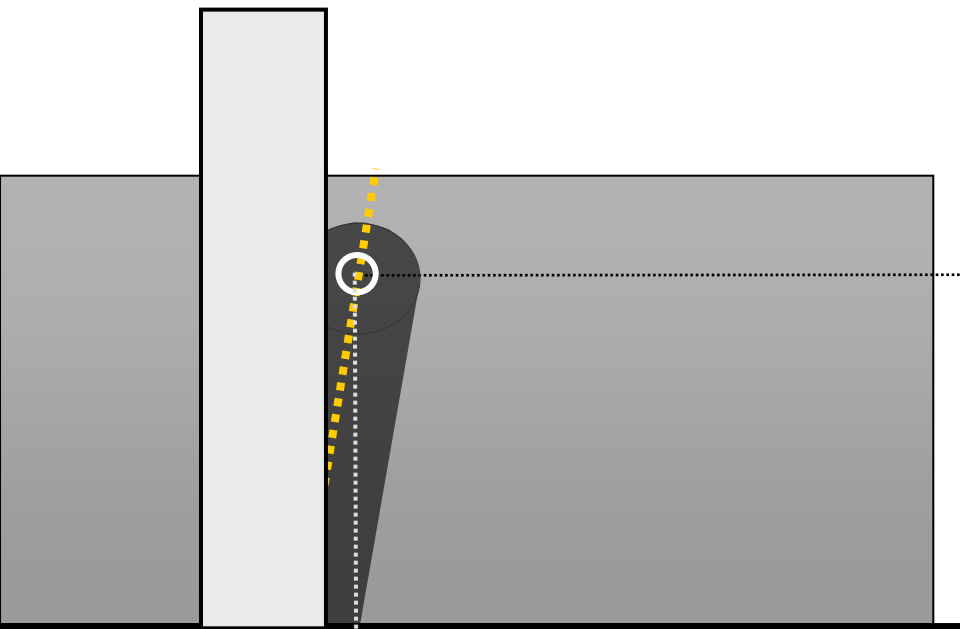

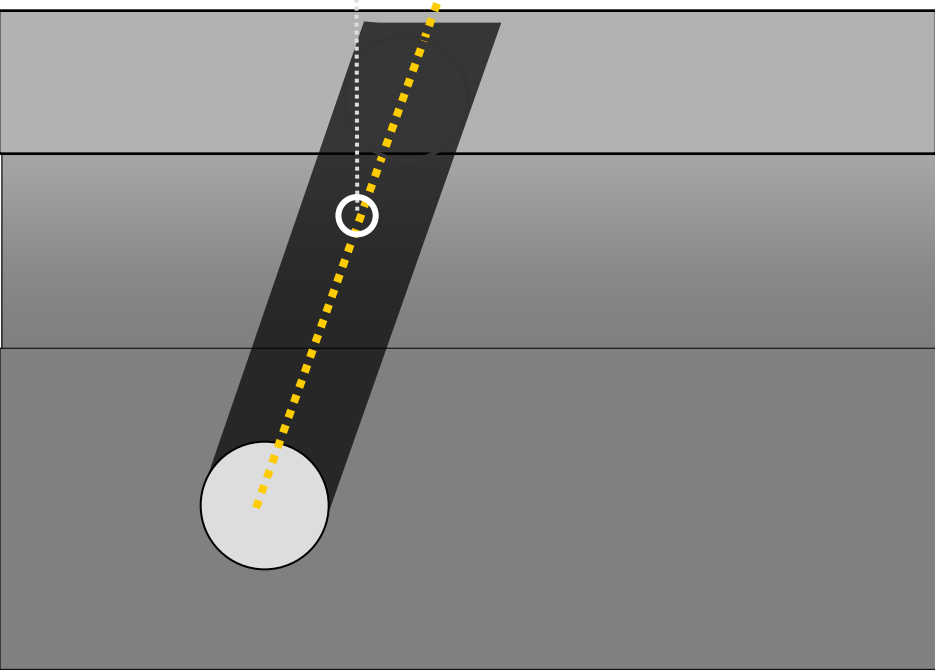
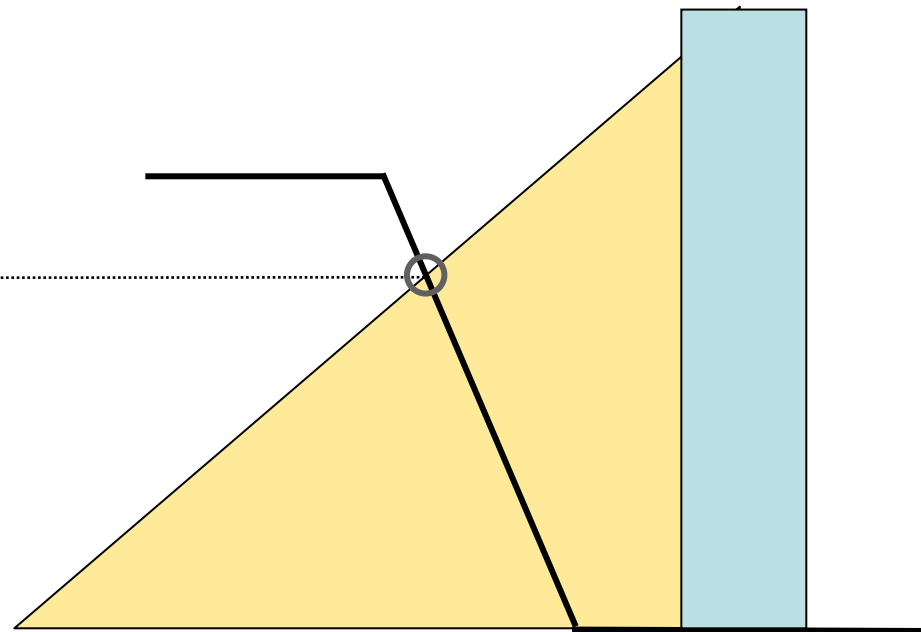
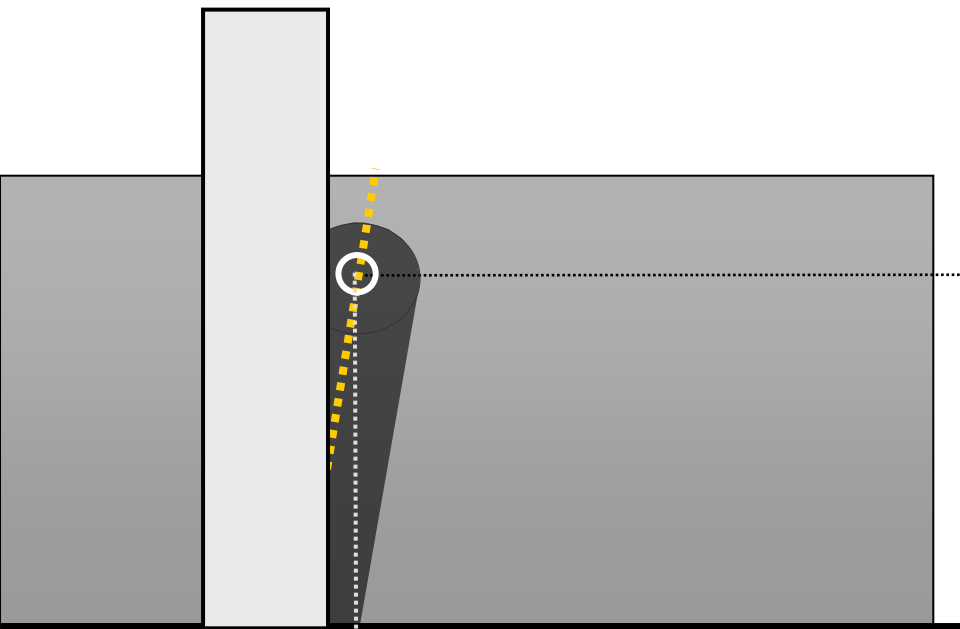

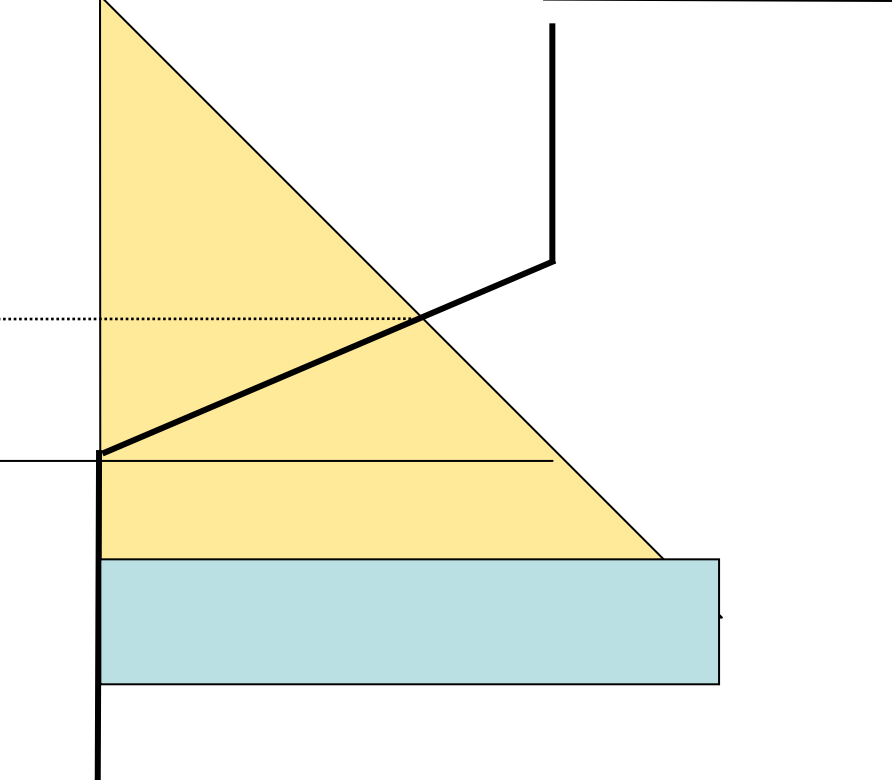
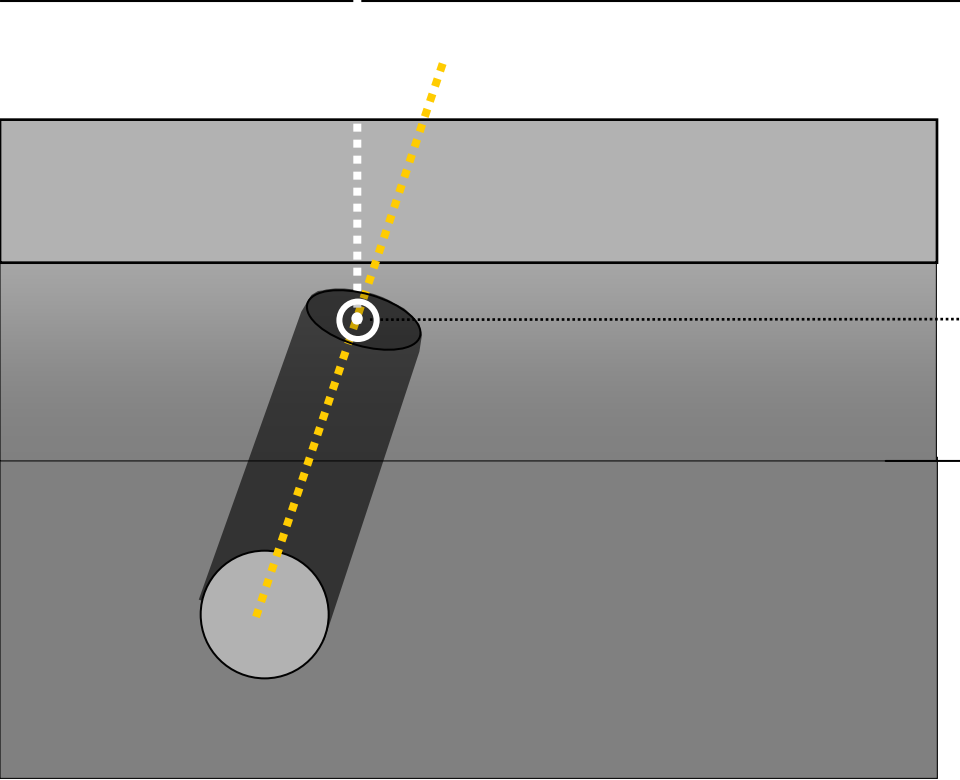
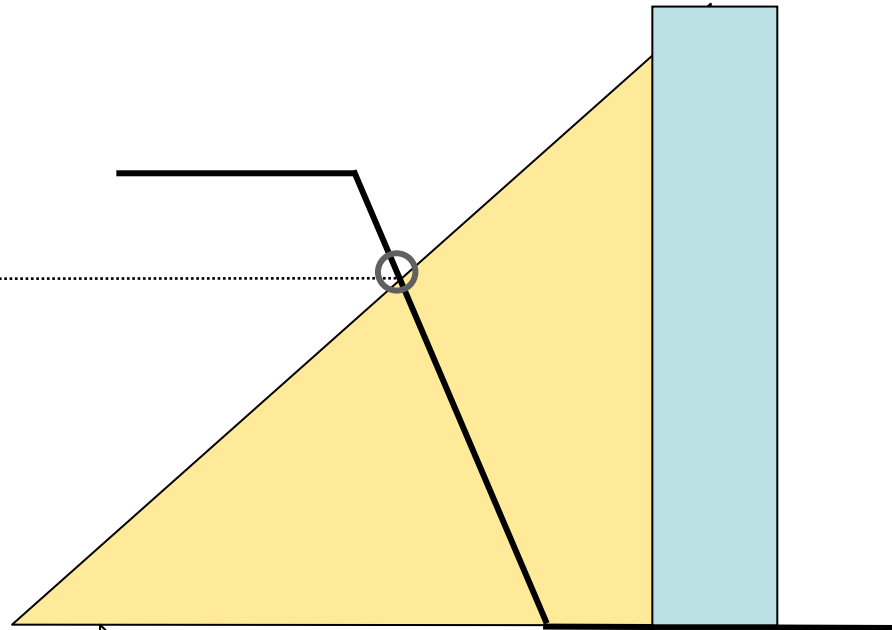
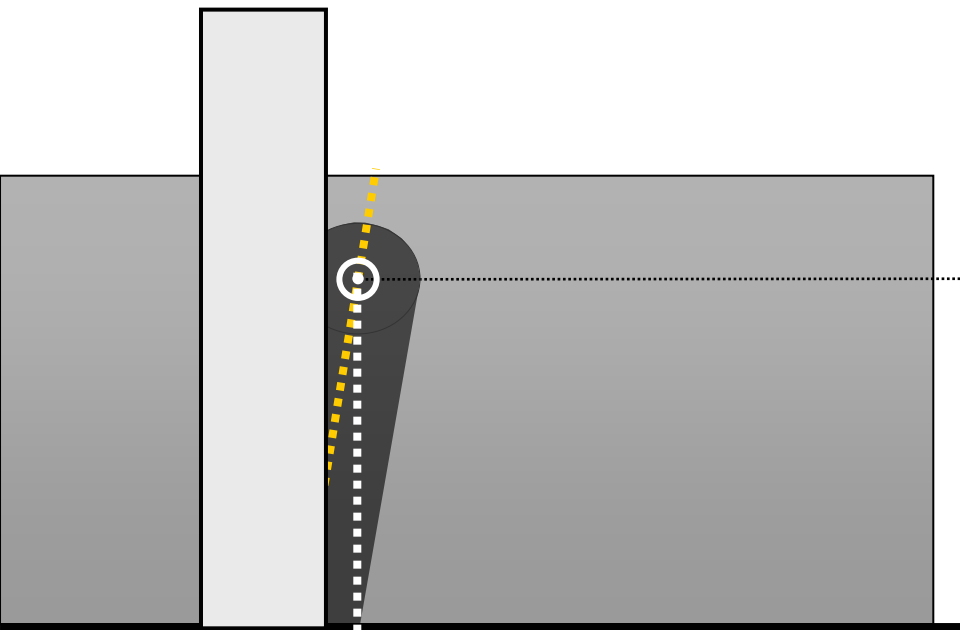

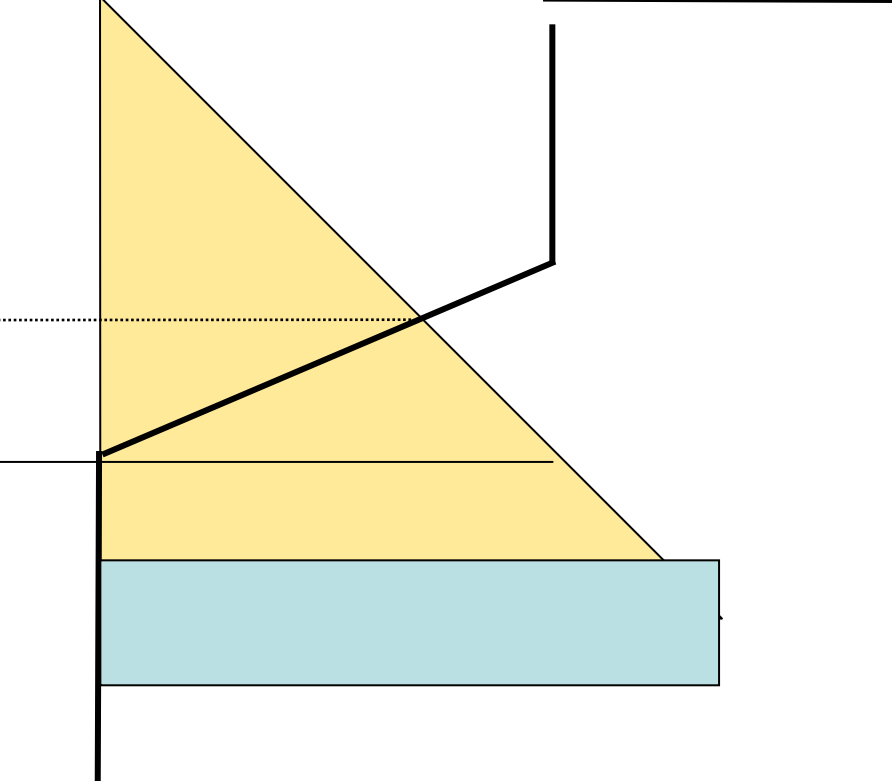
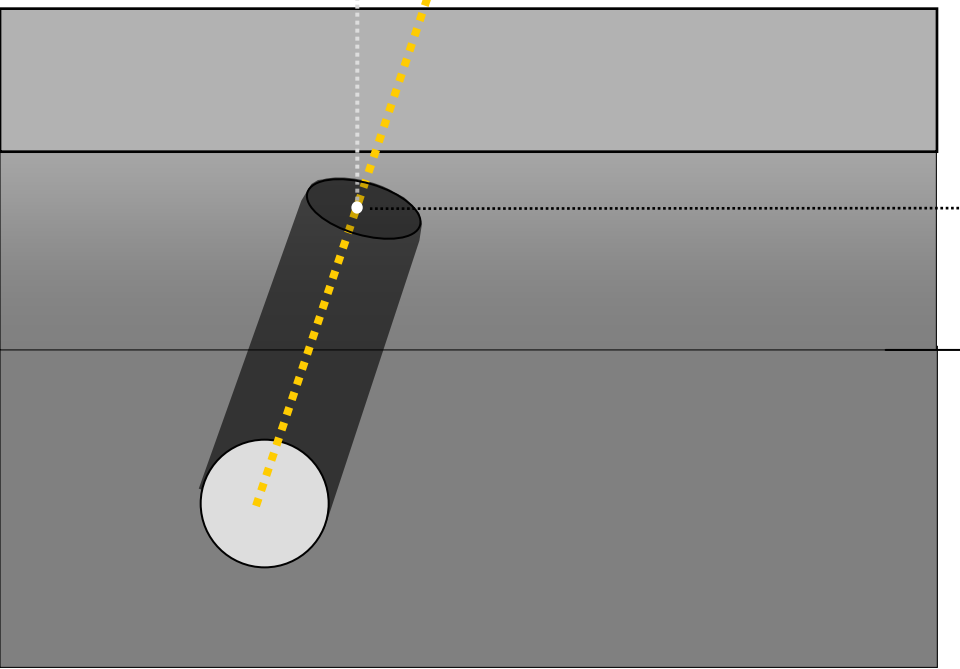
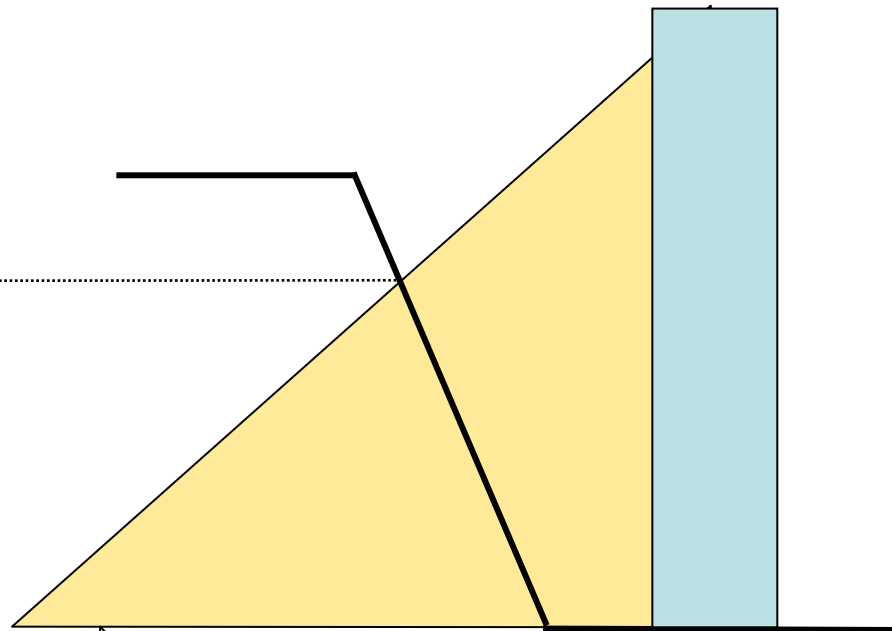
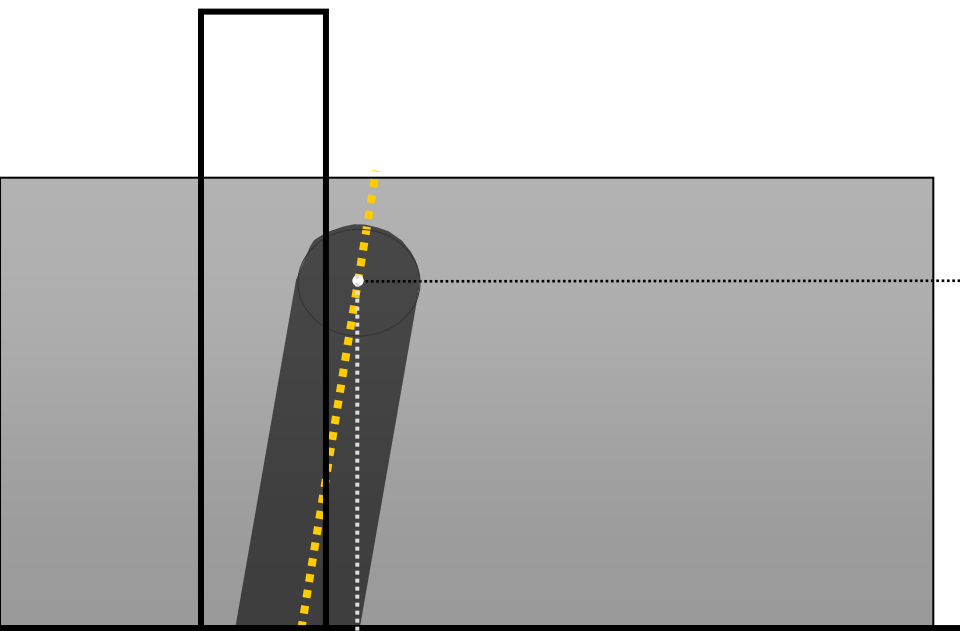

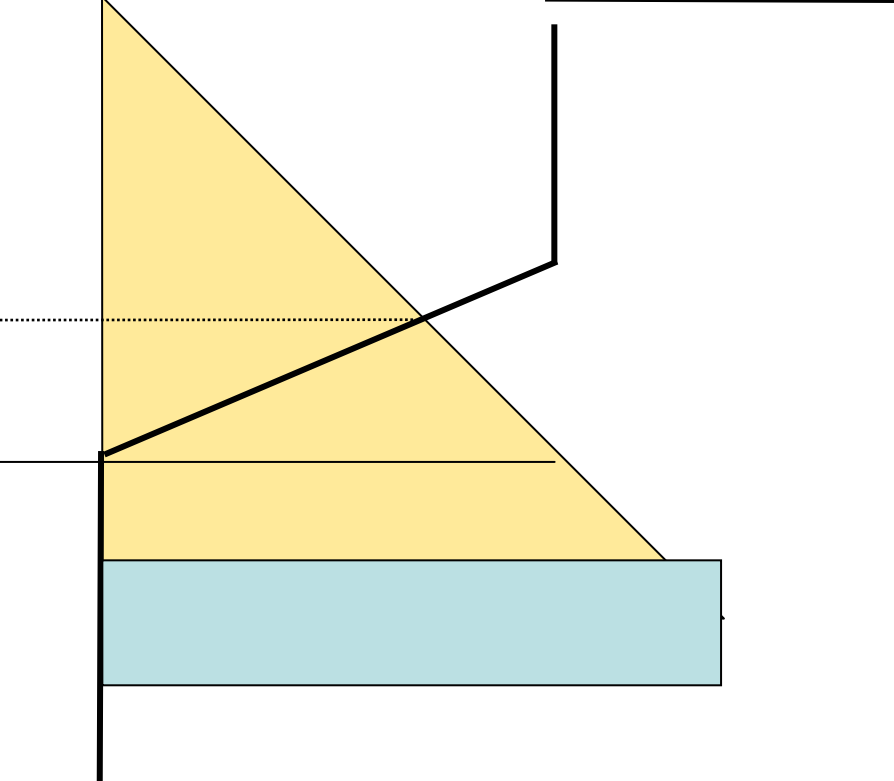
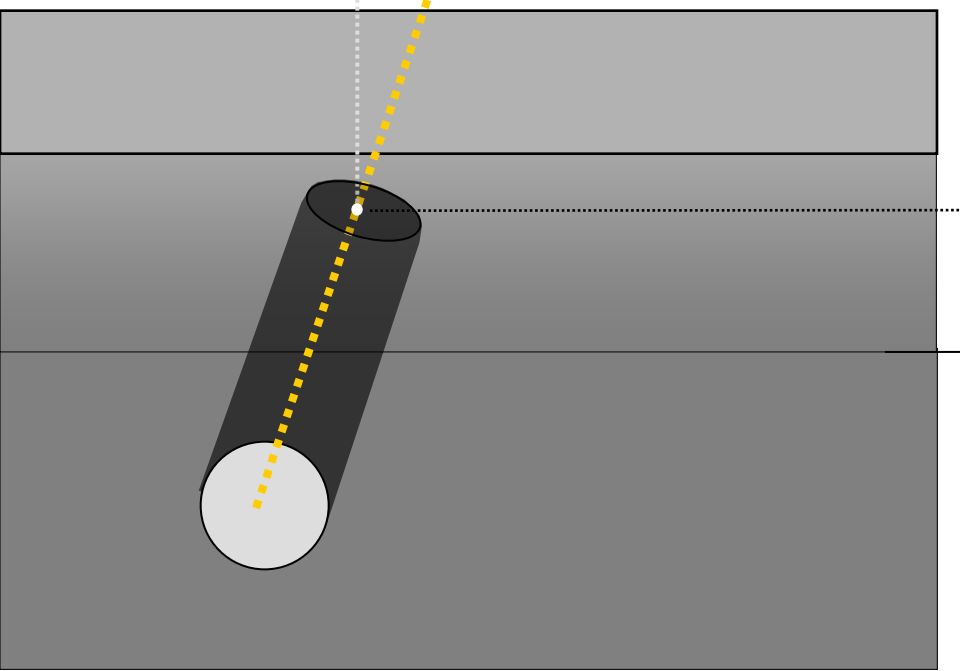
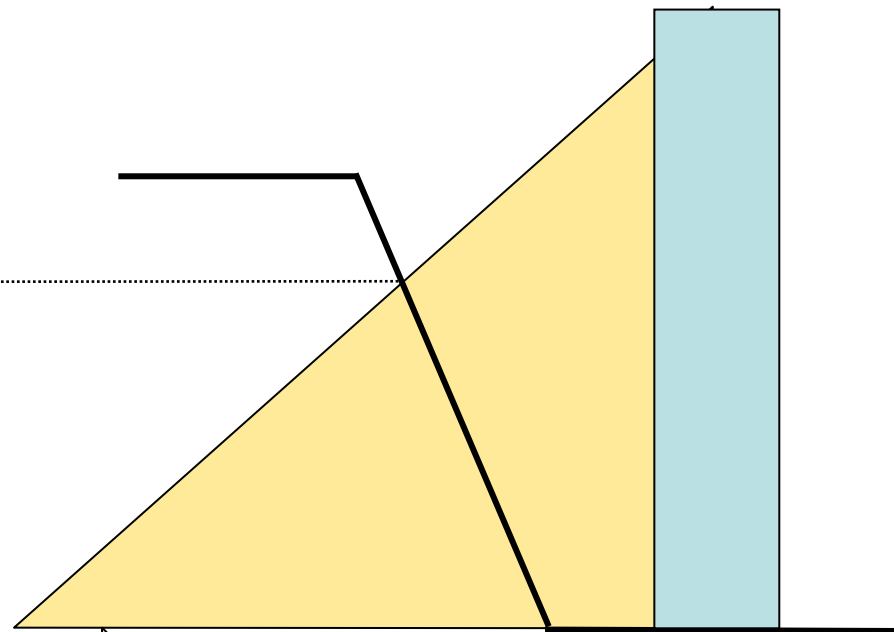
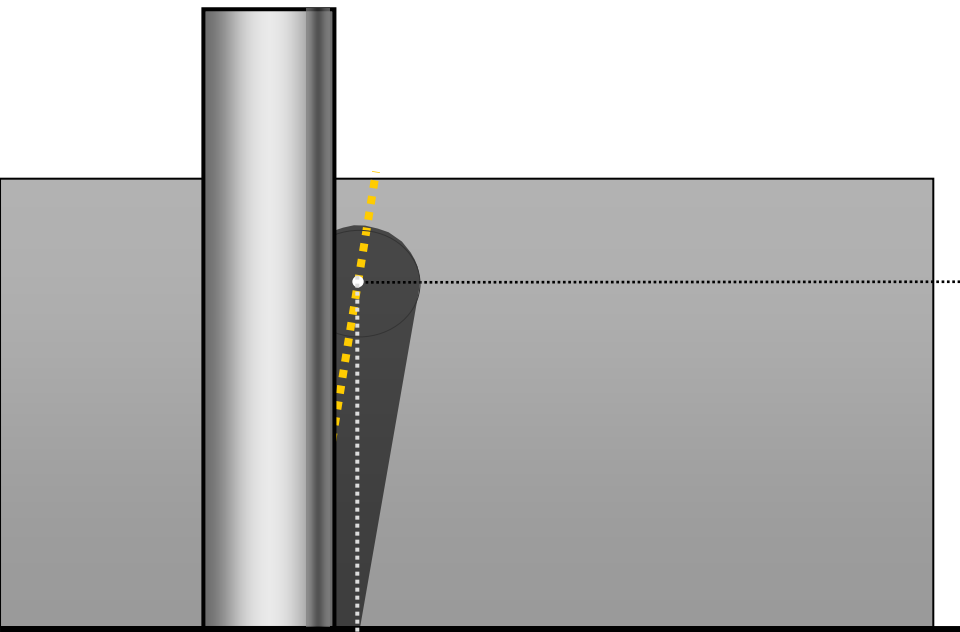

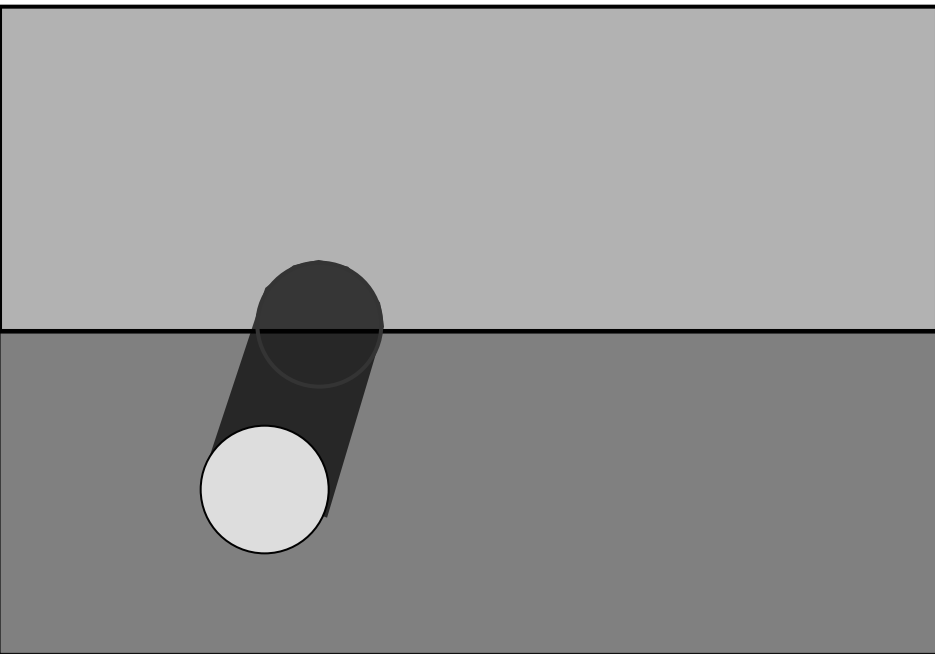
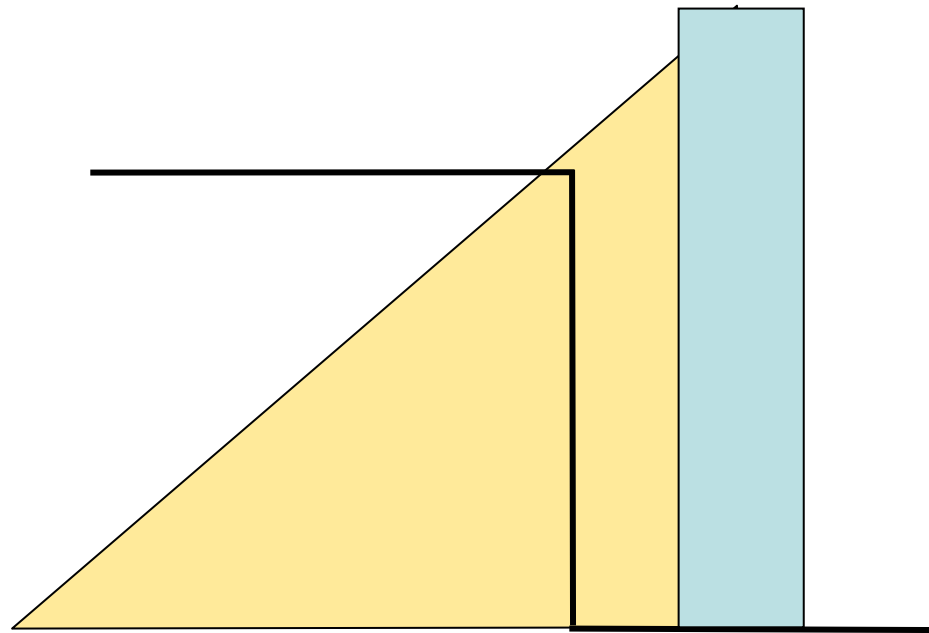
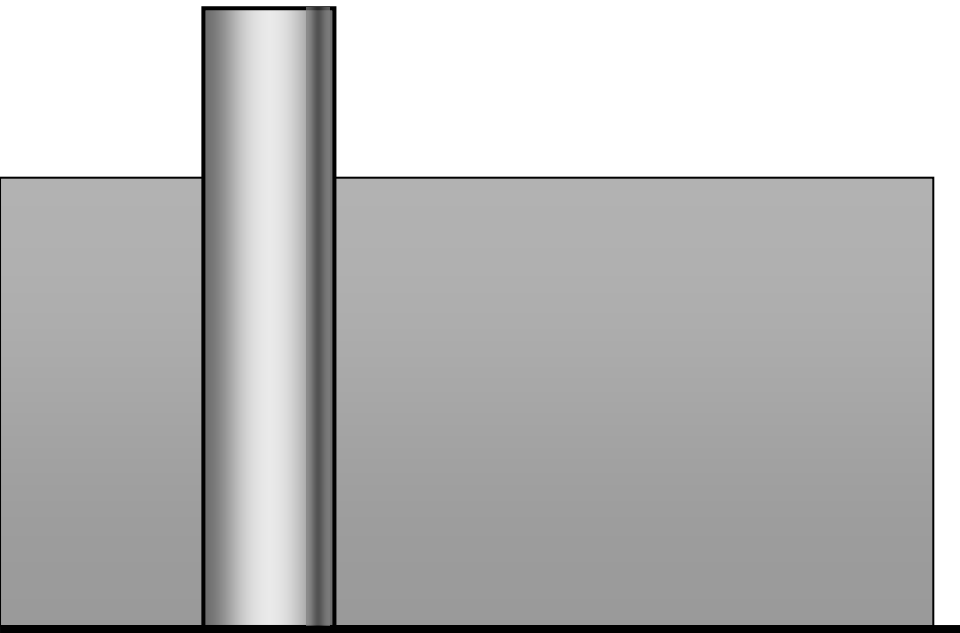

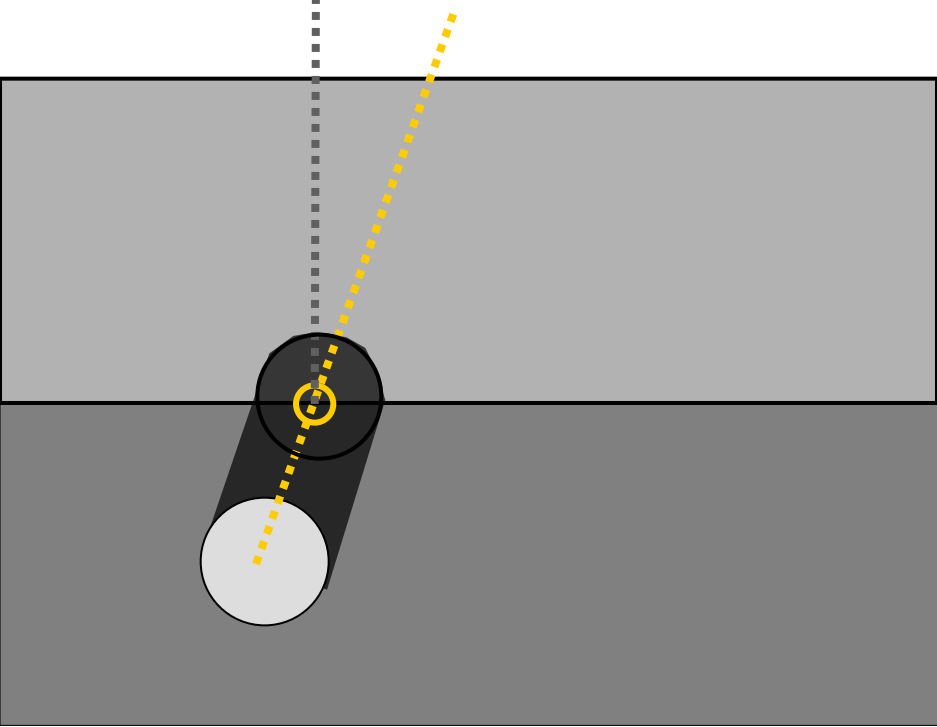
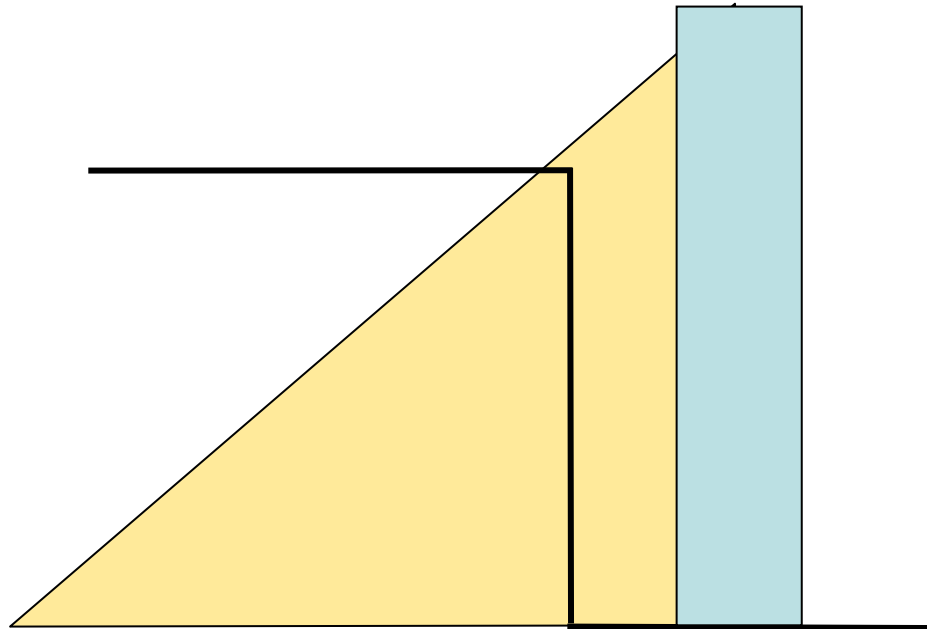
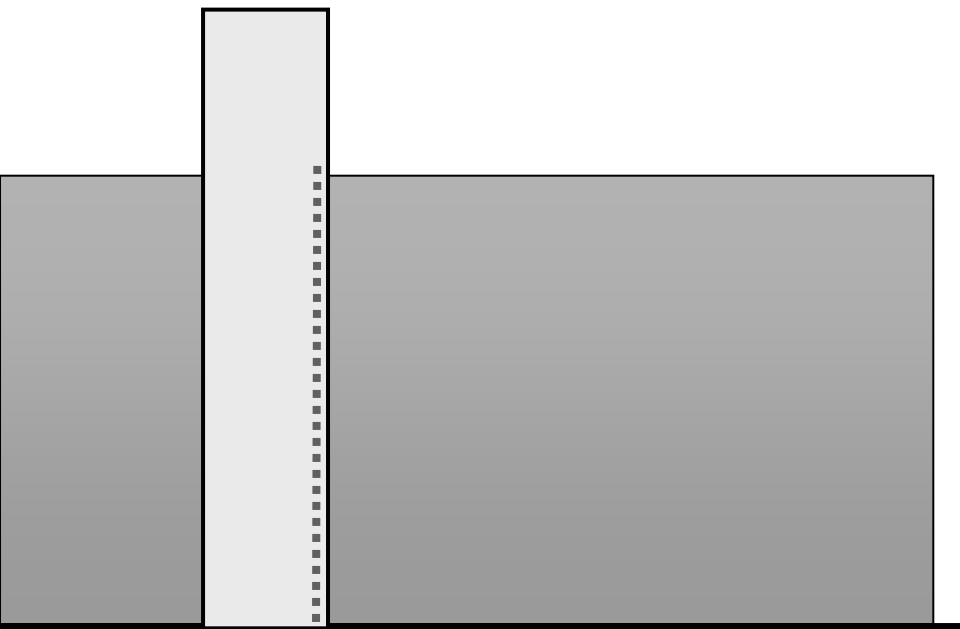

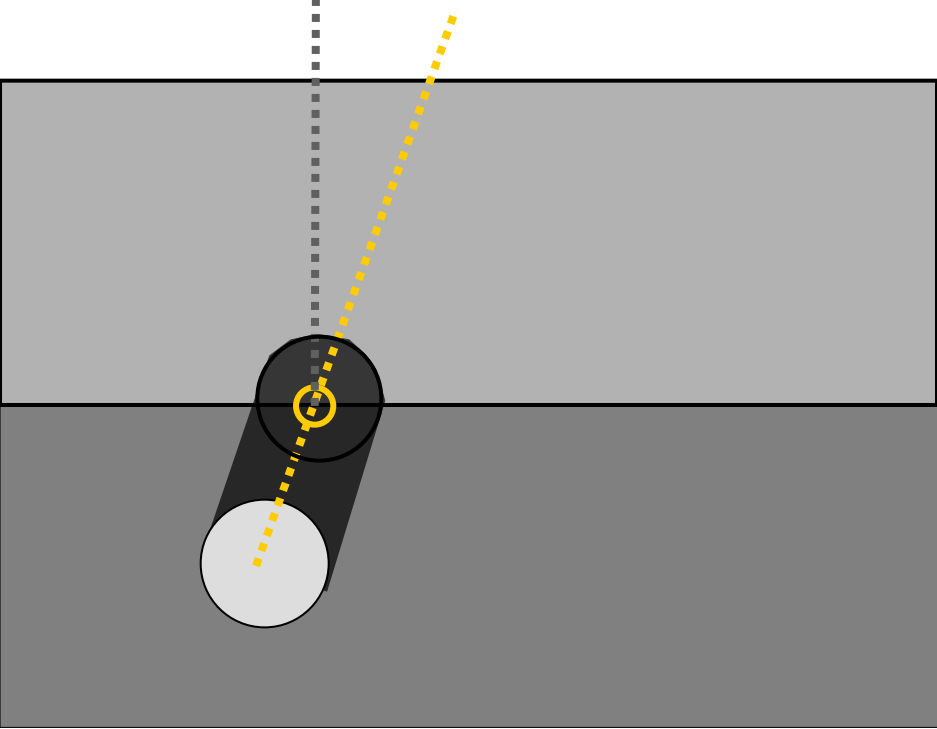
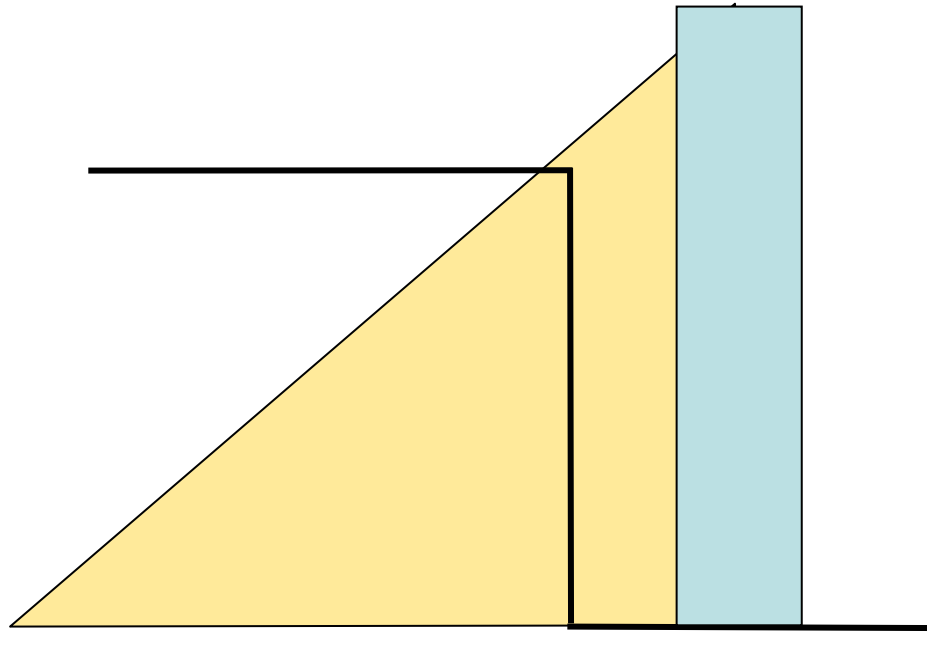
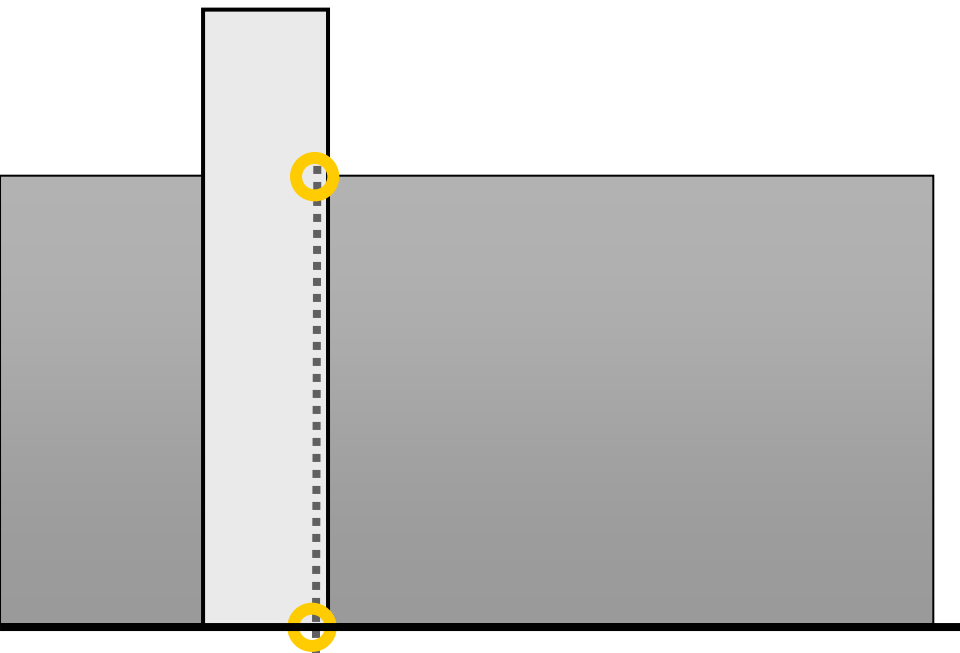

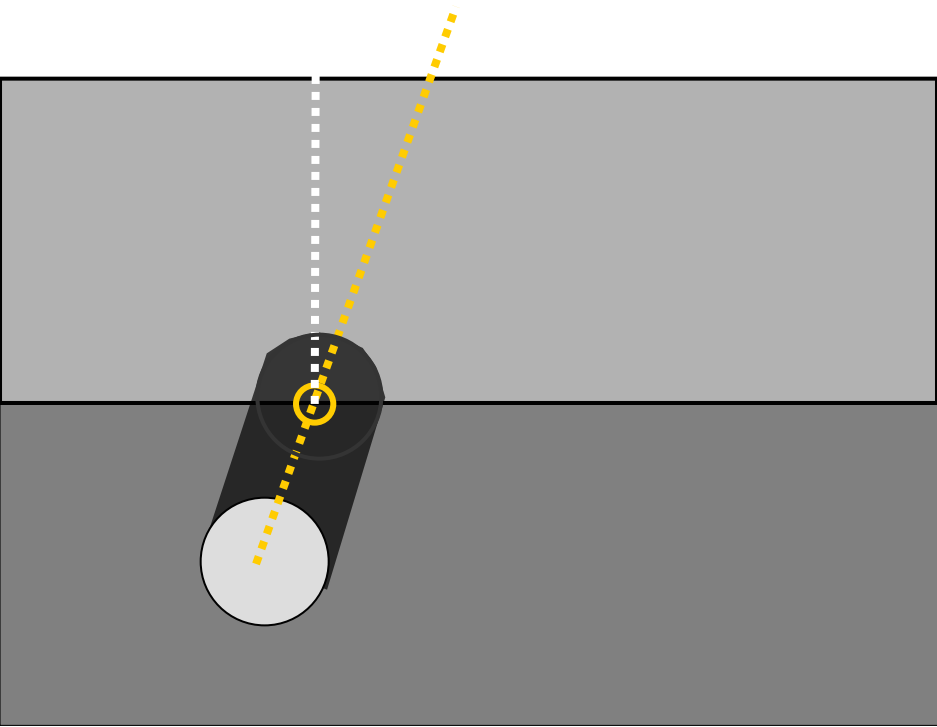
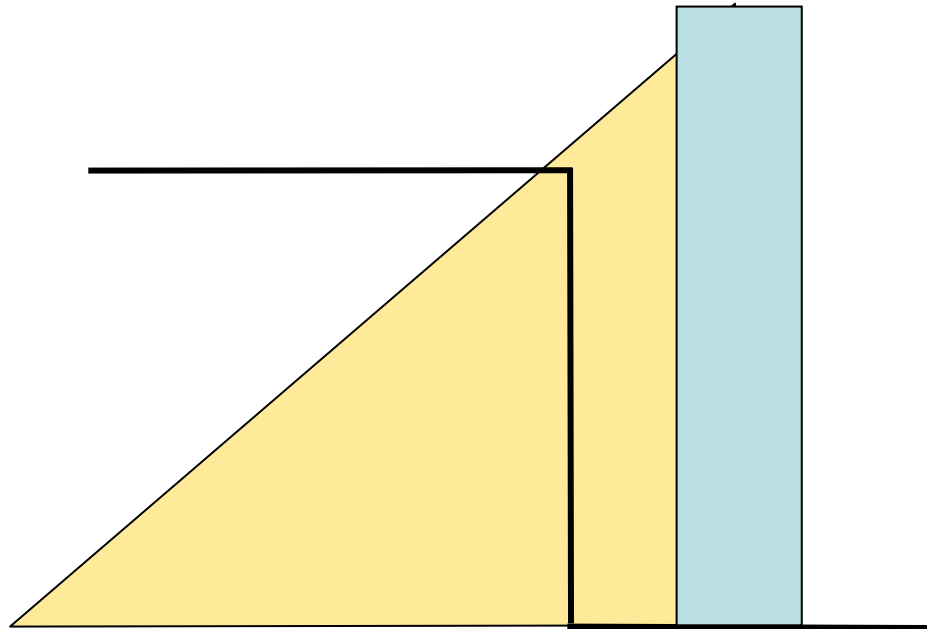
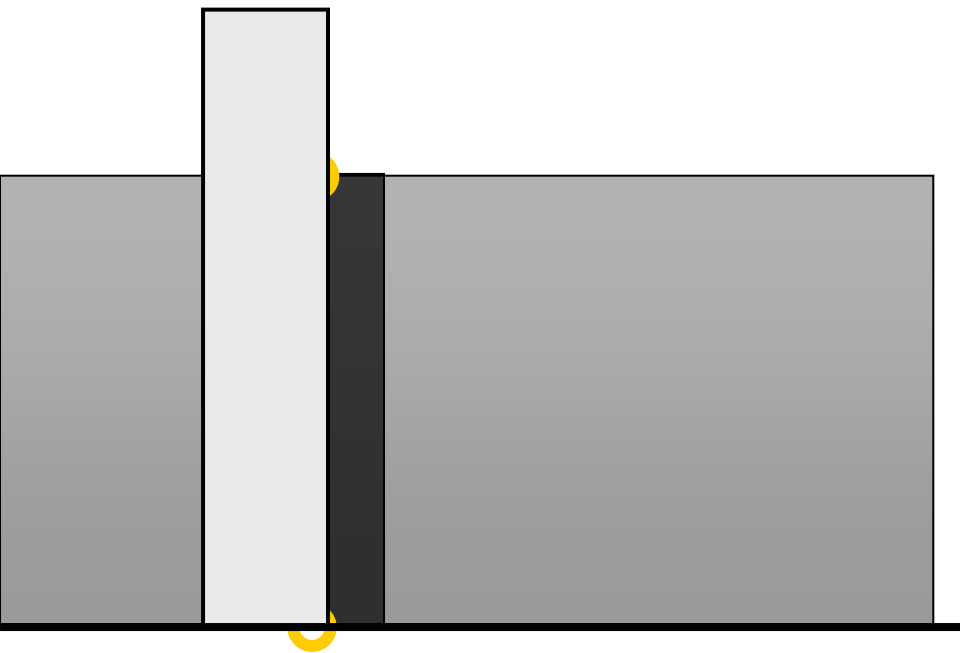

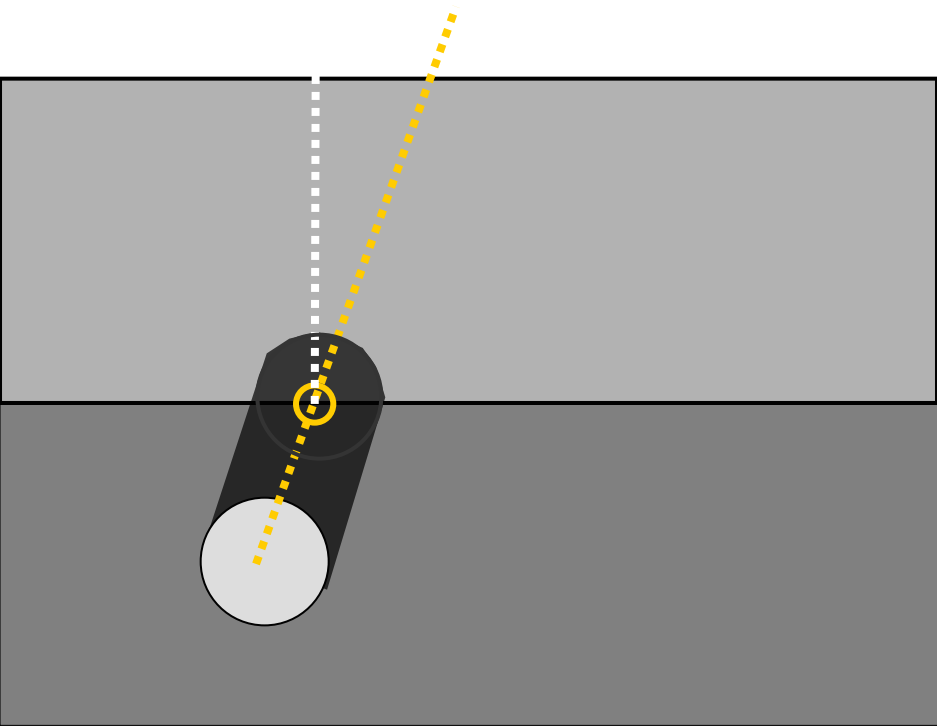
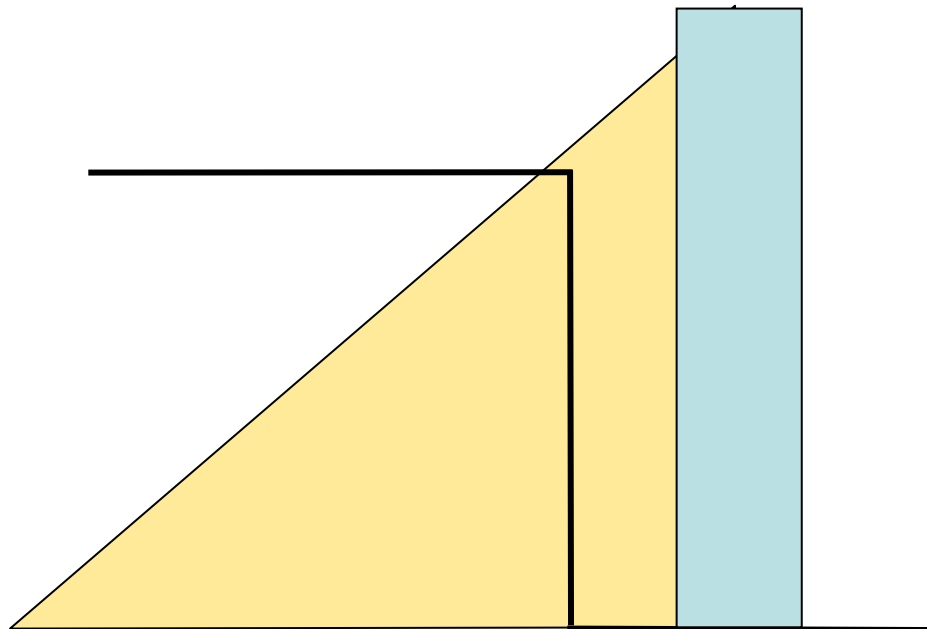
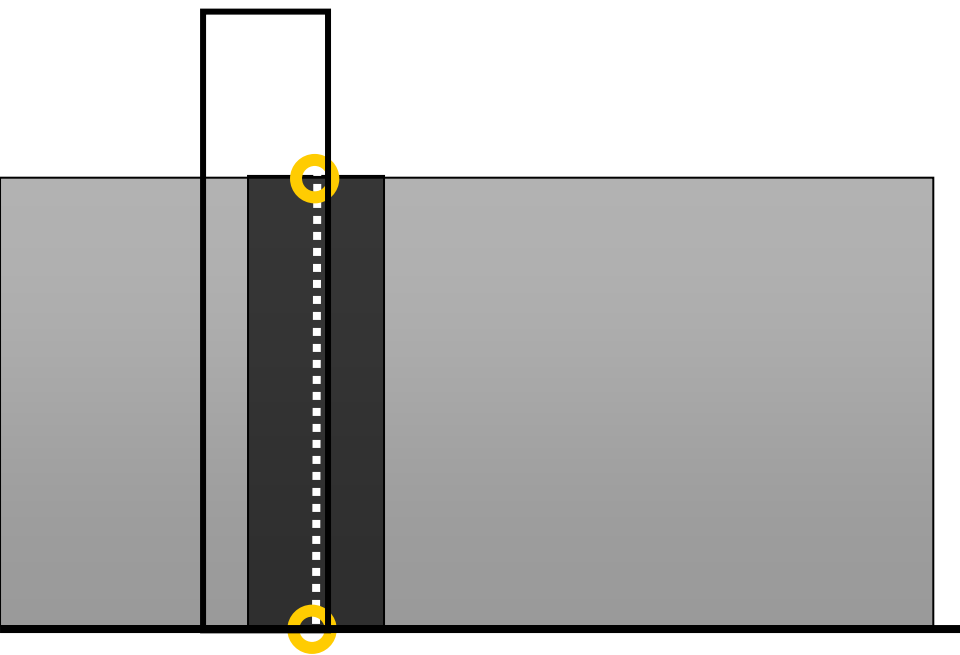

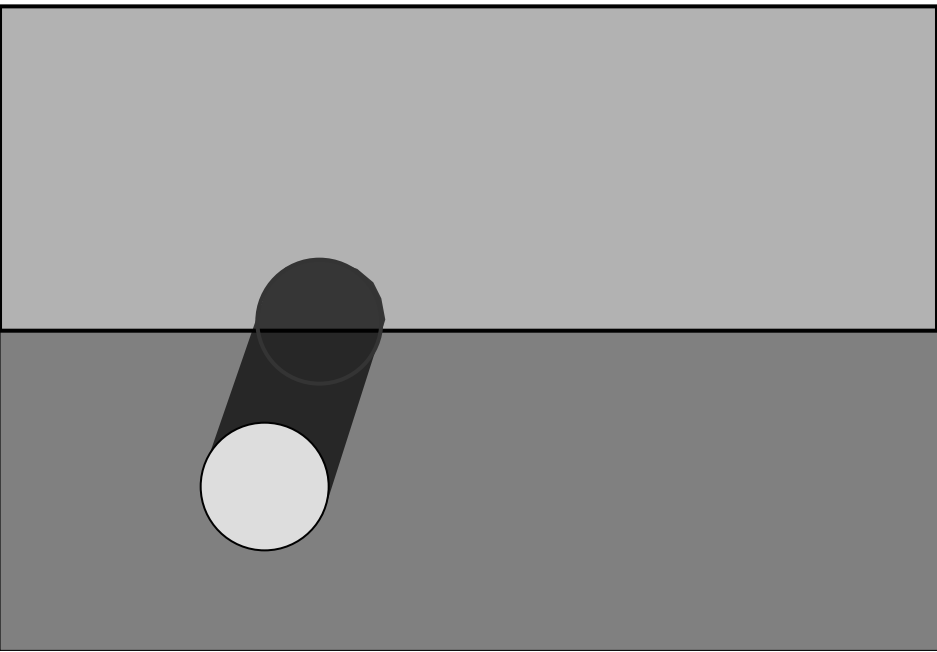
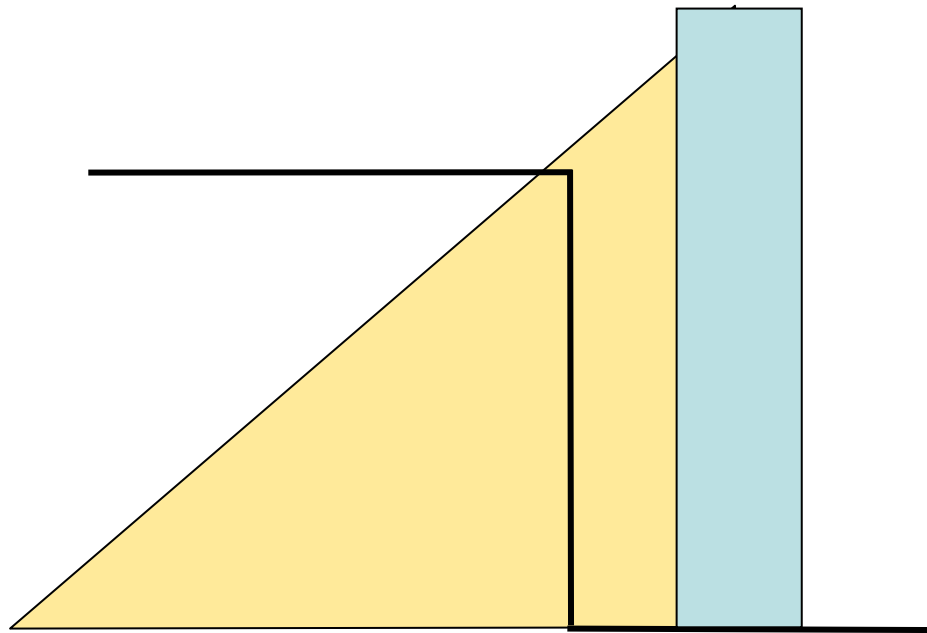
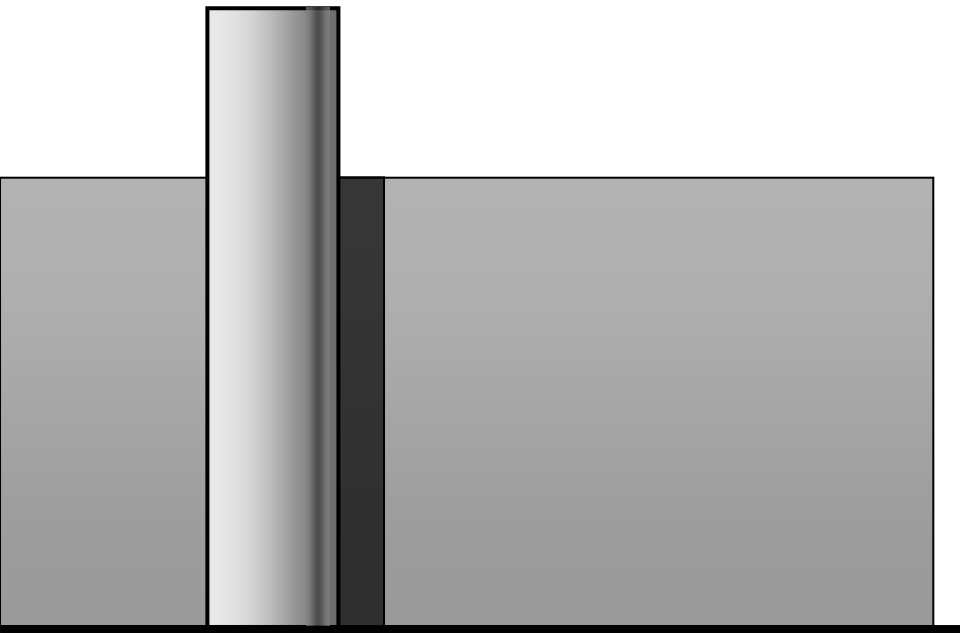

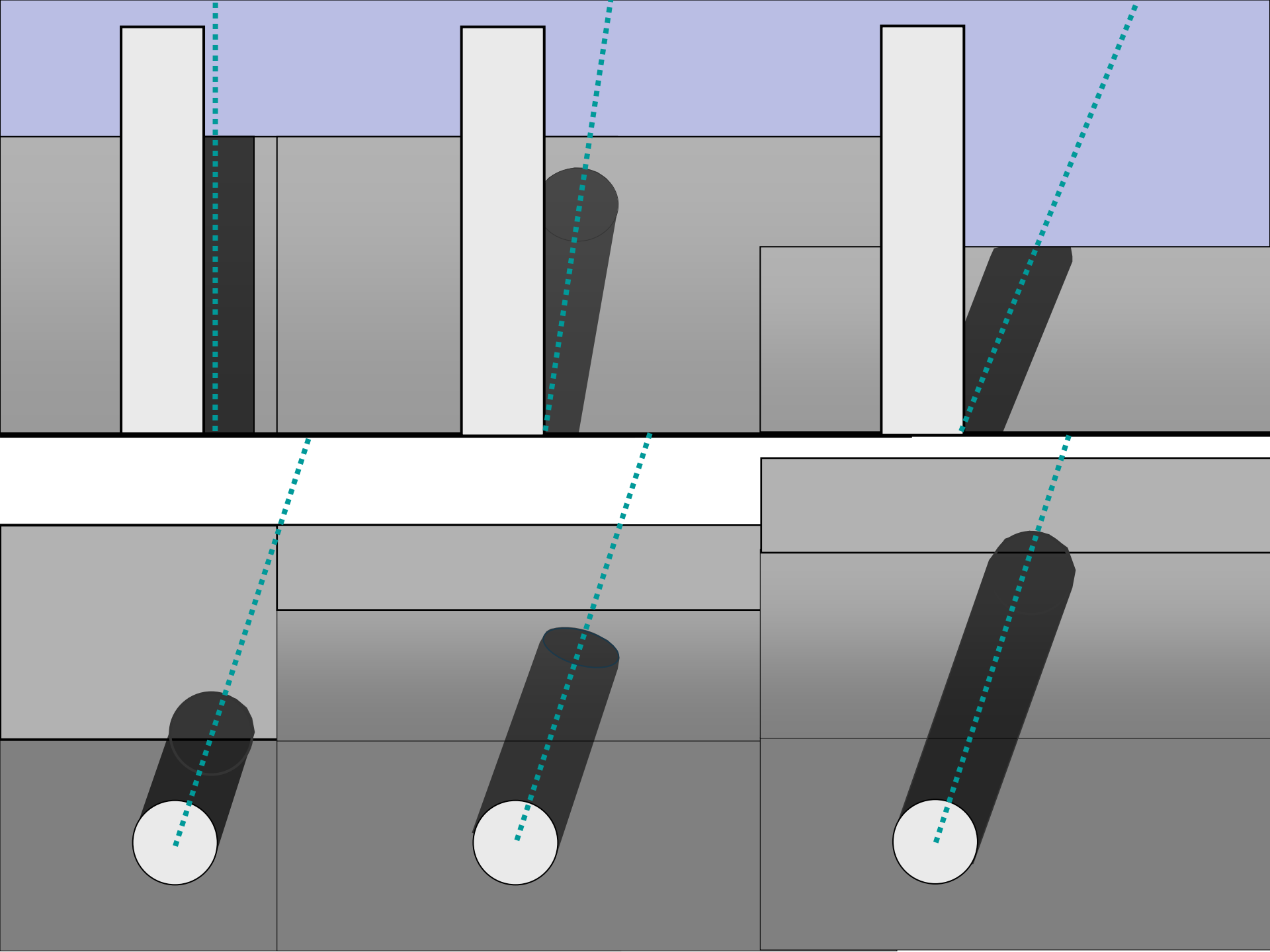

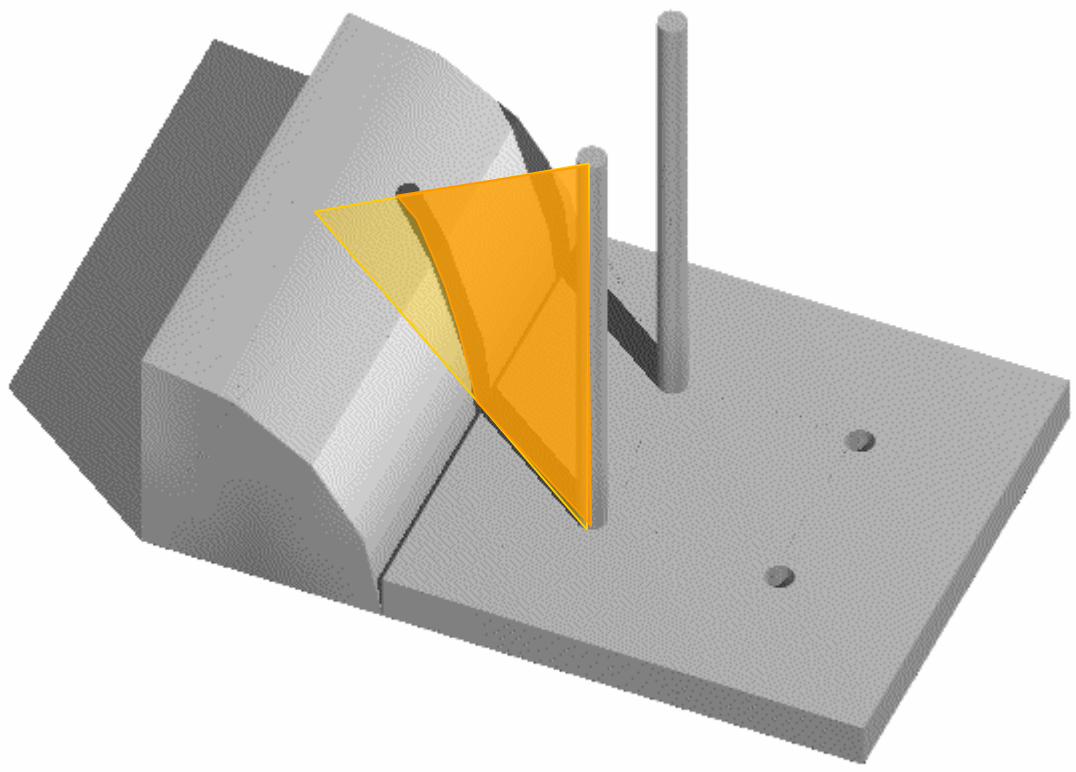

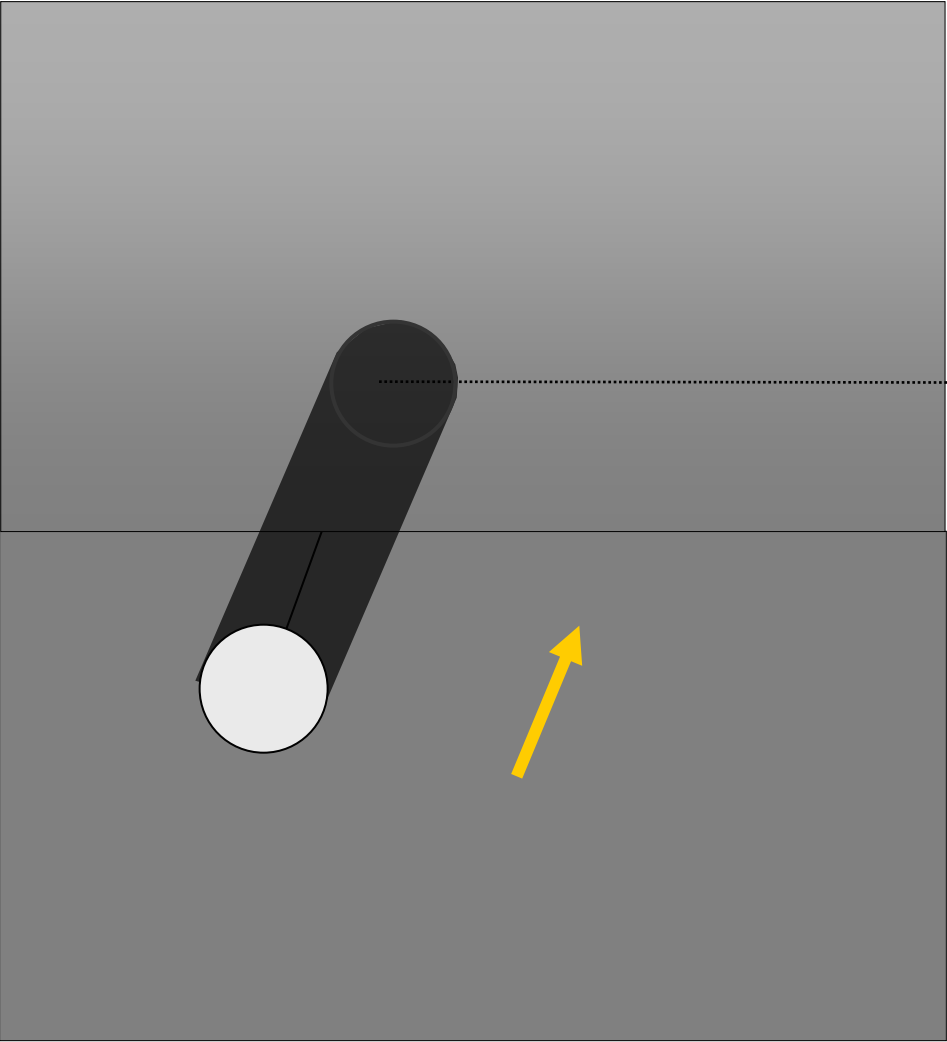

PLANTA

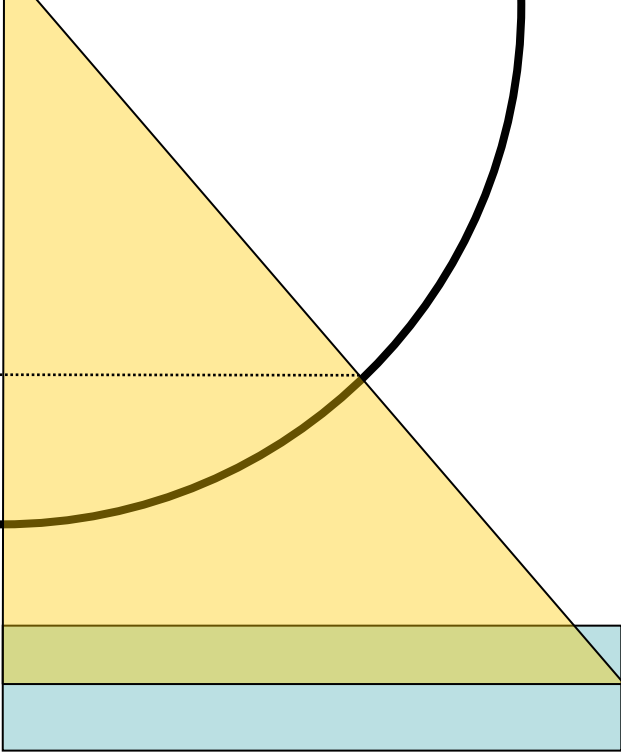

VISTA LATERAL

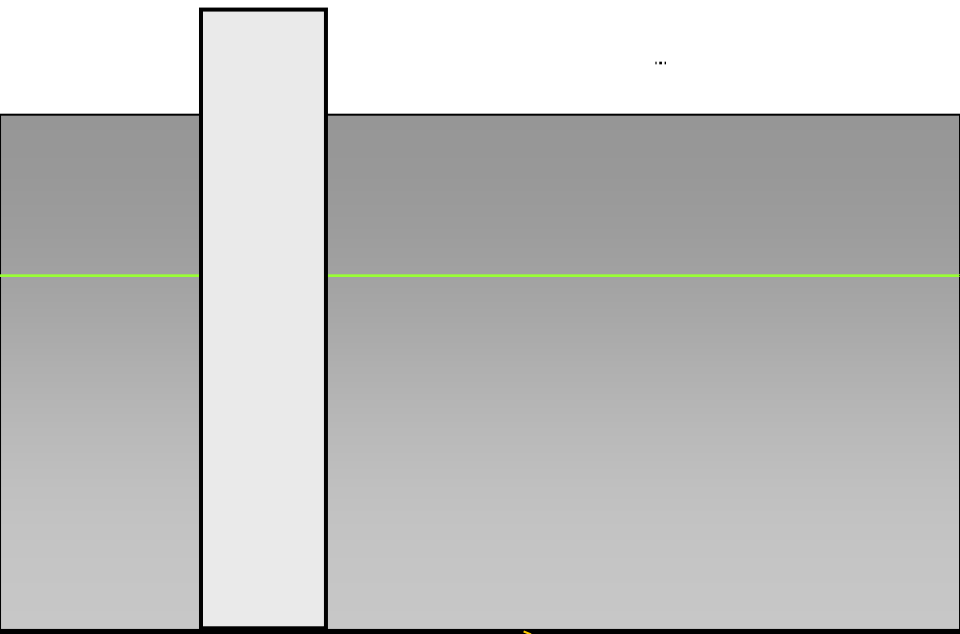

VISTA FRONTAL

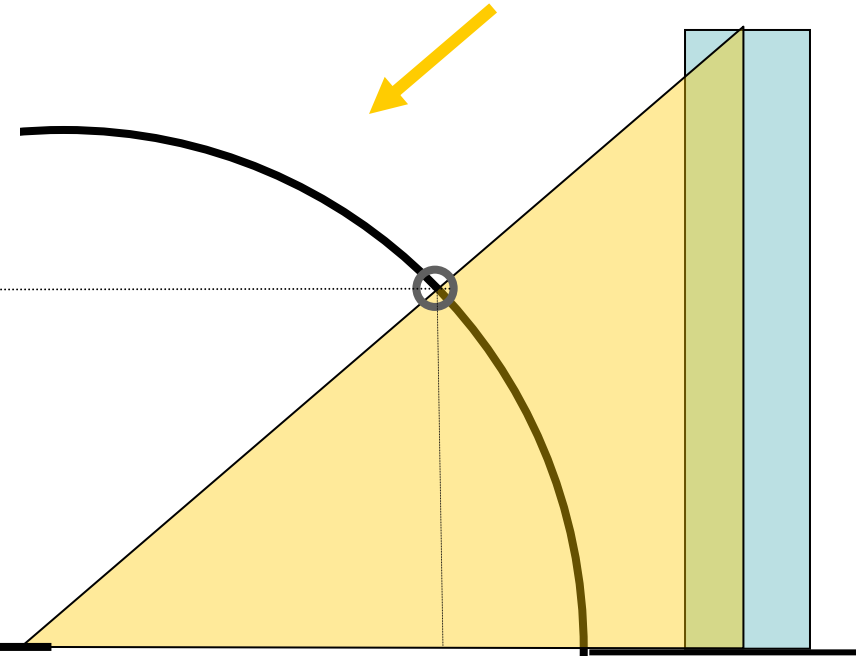

VISTA LATERAL

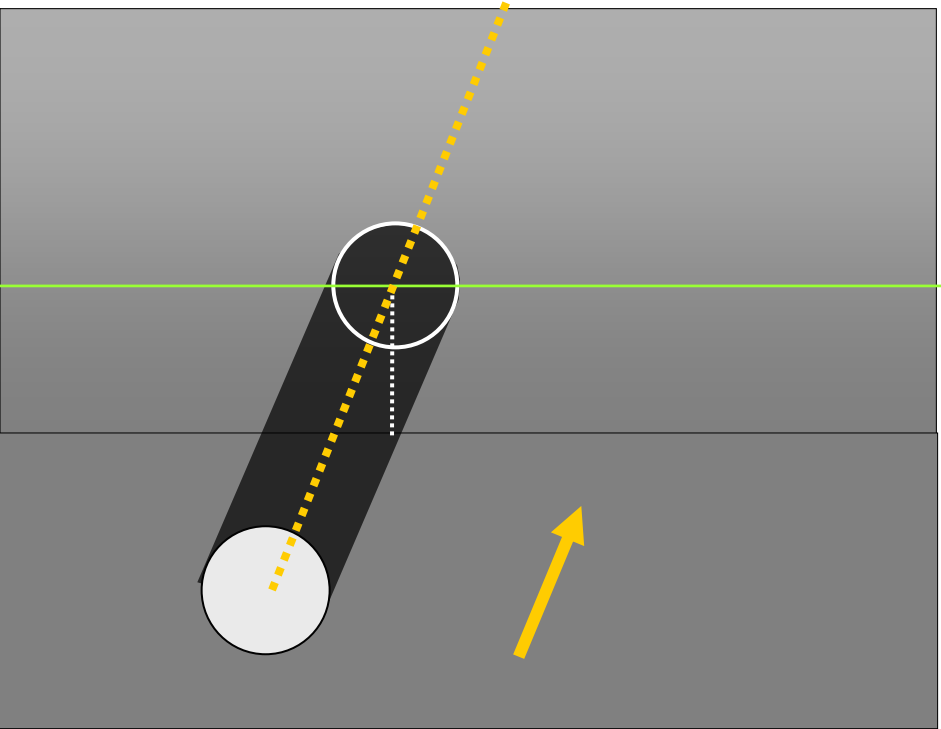

PLANTA

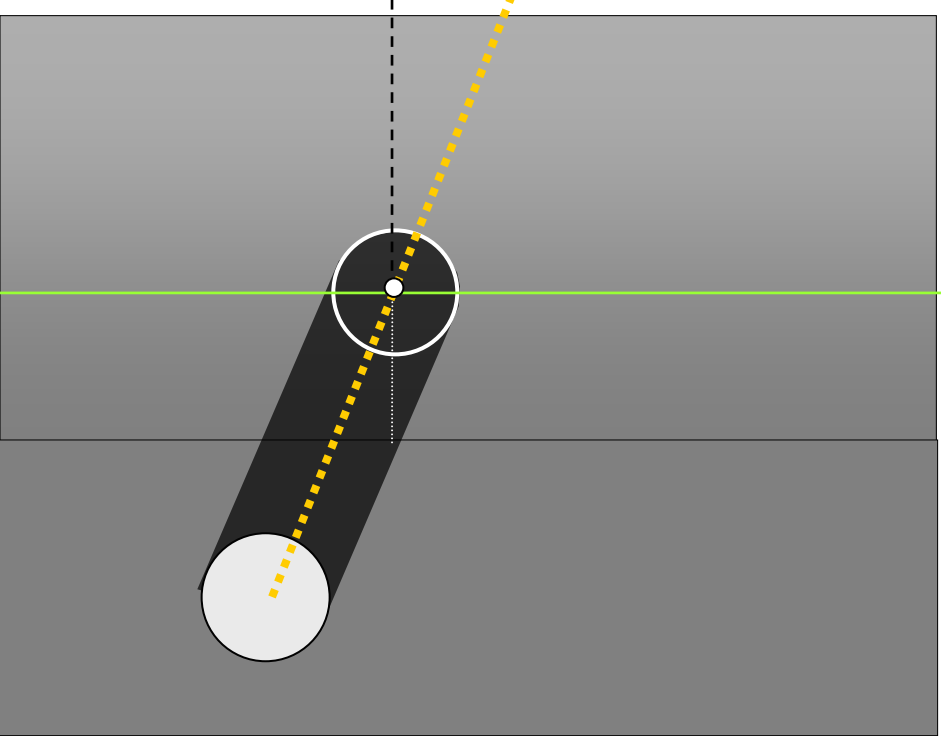
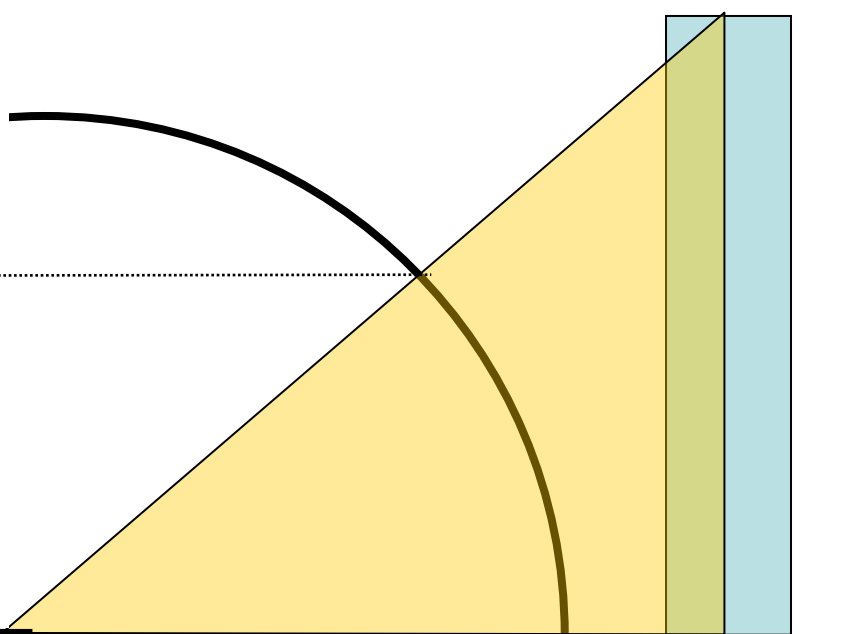
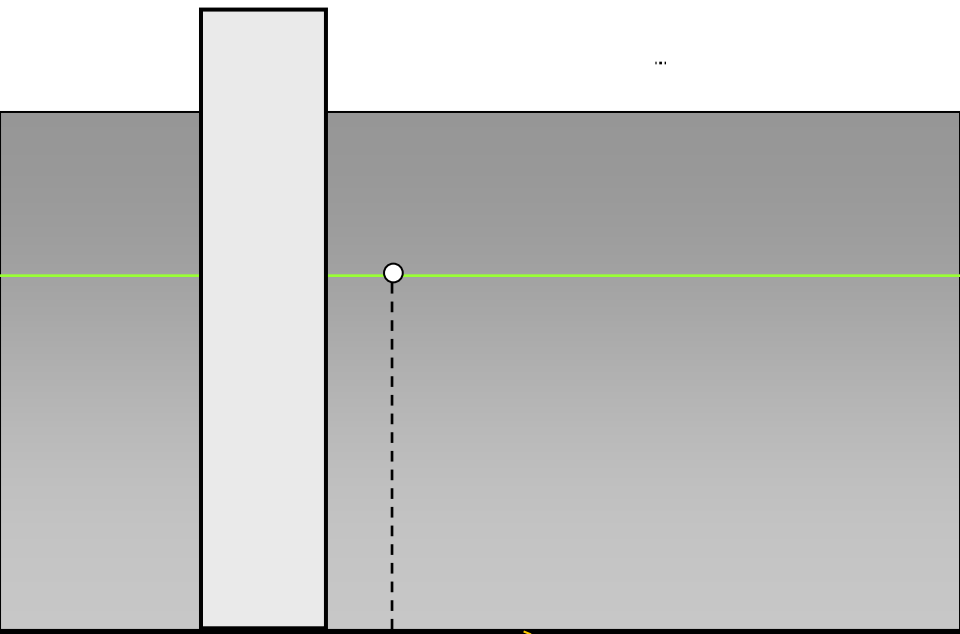

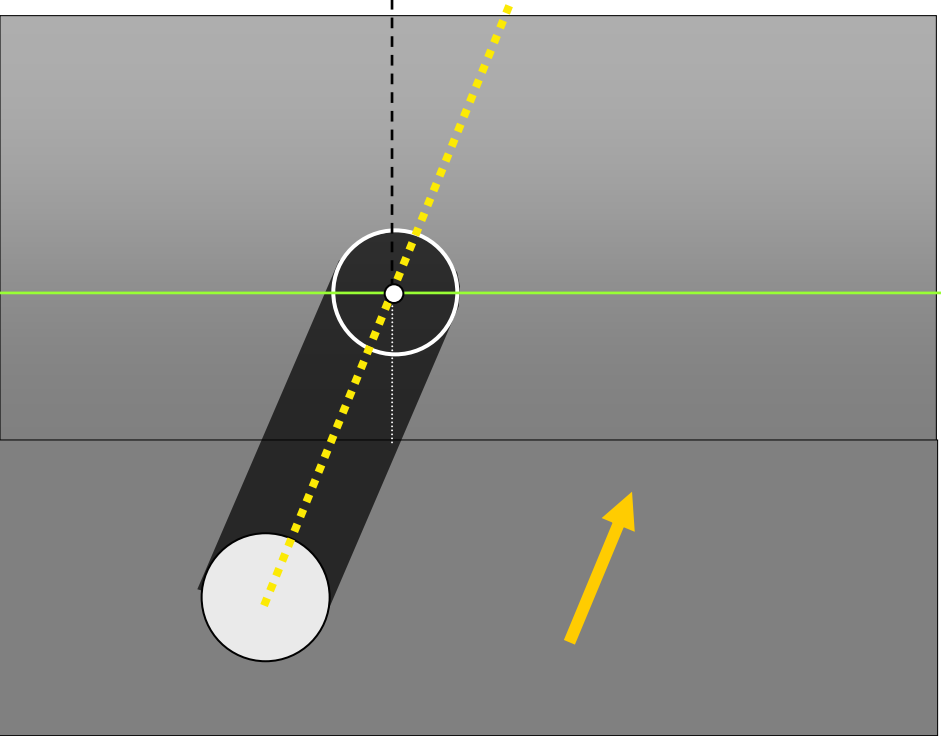
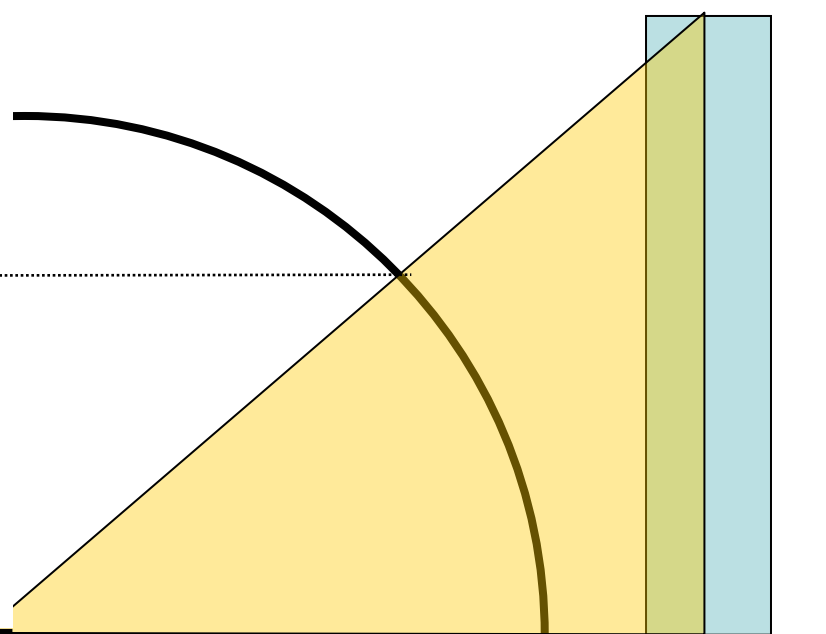
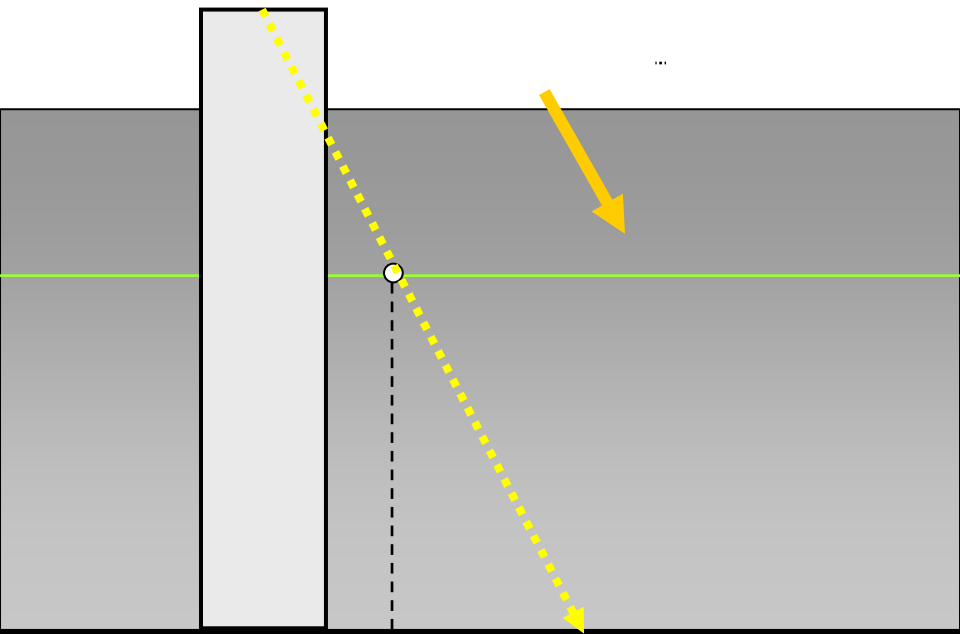

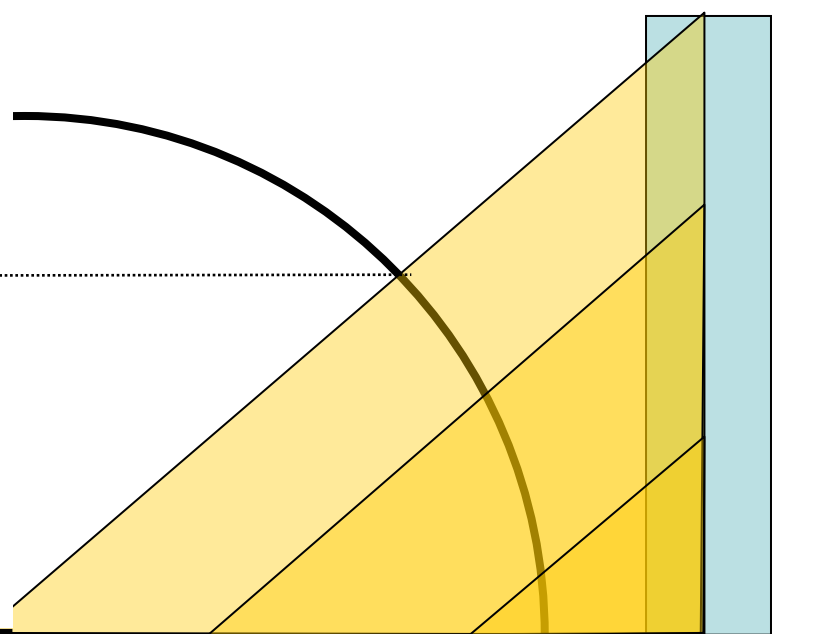
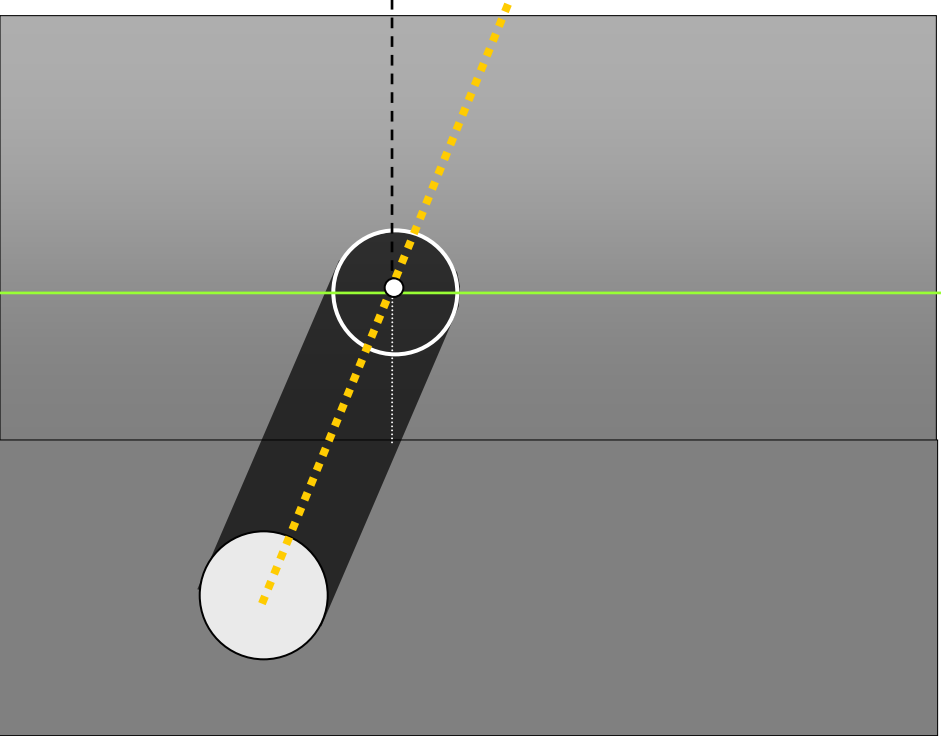
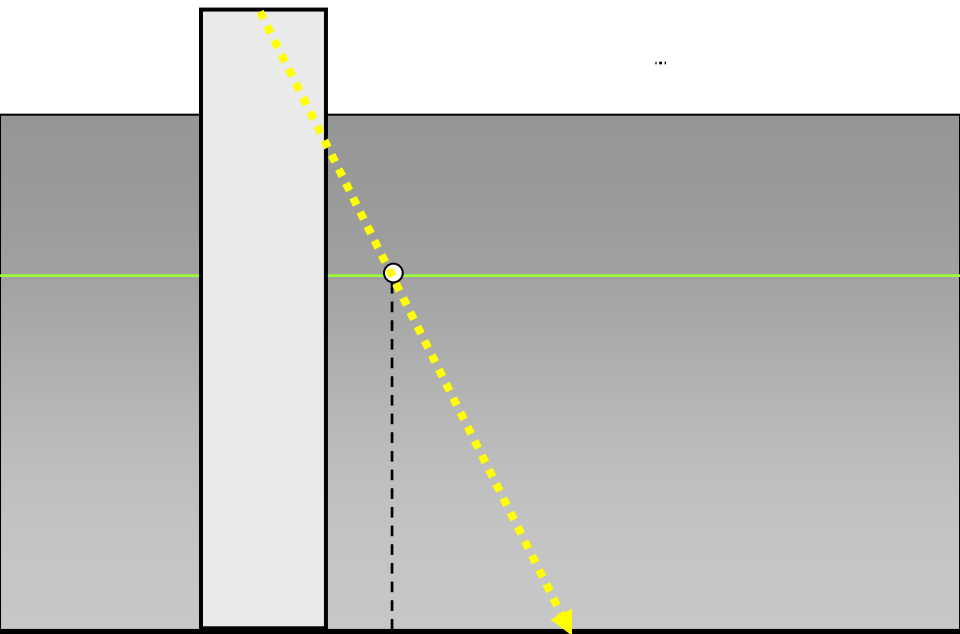

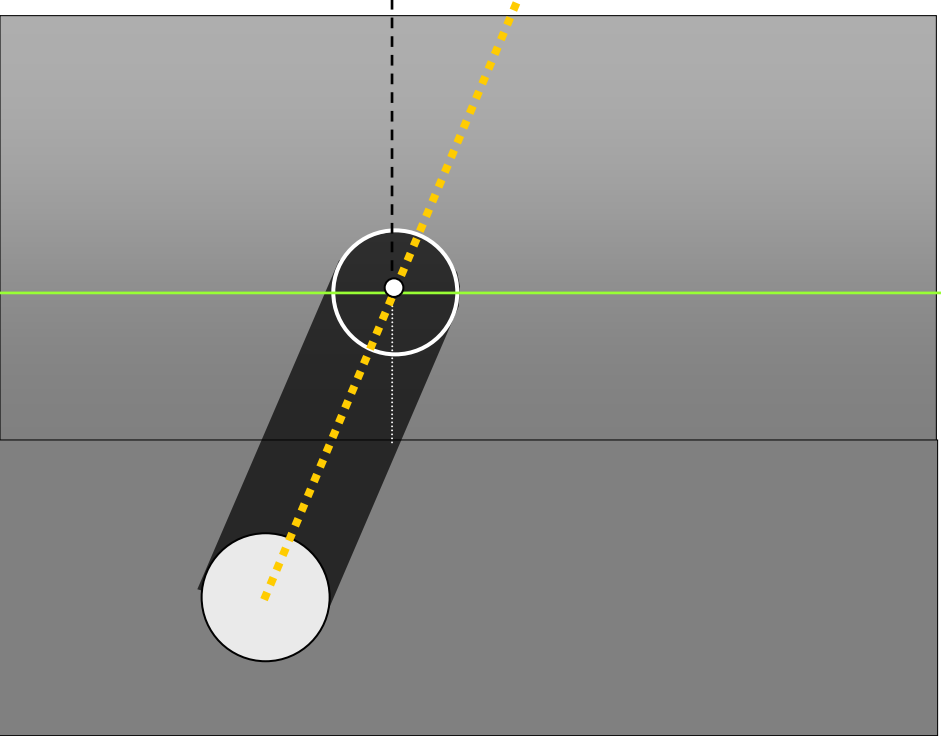
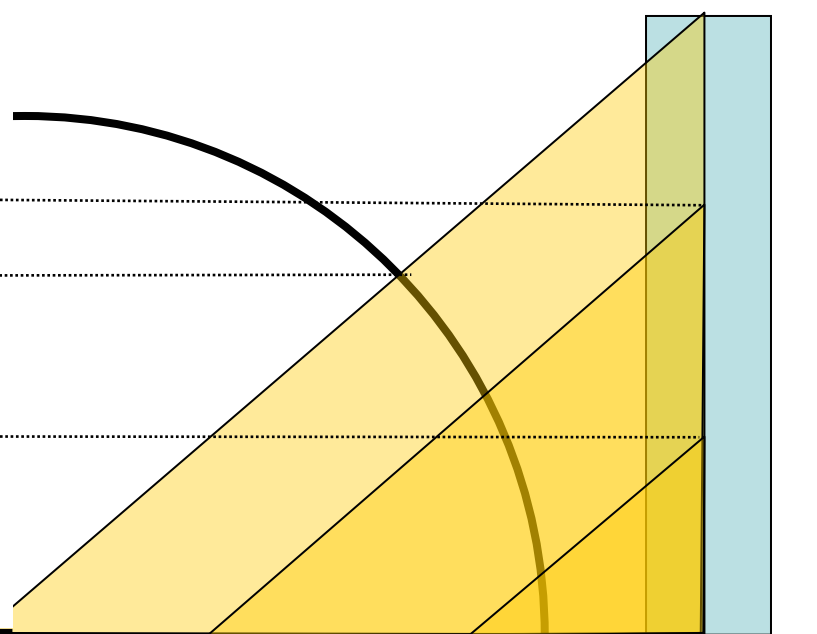
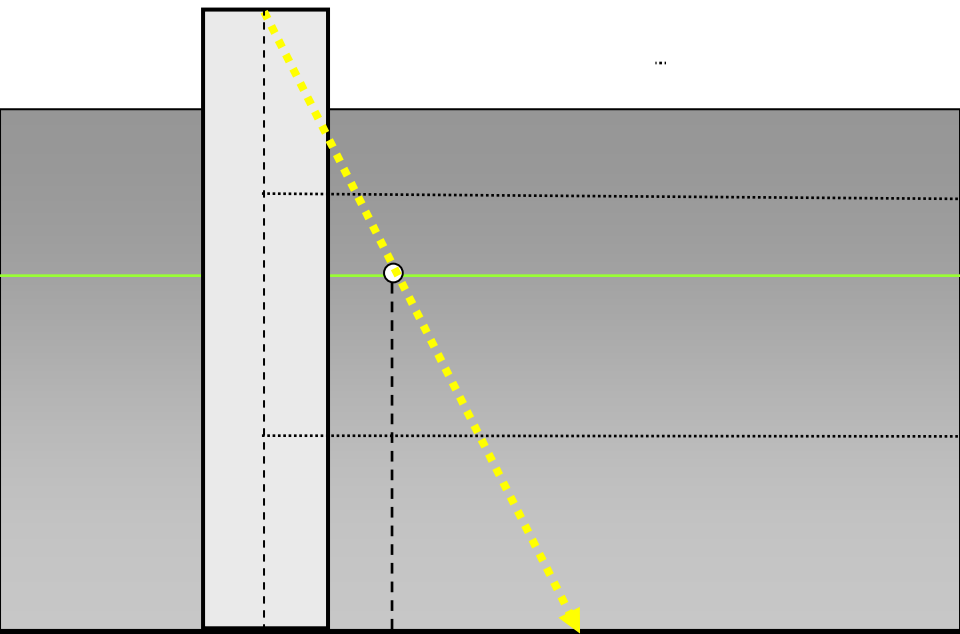

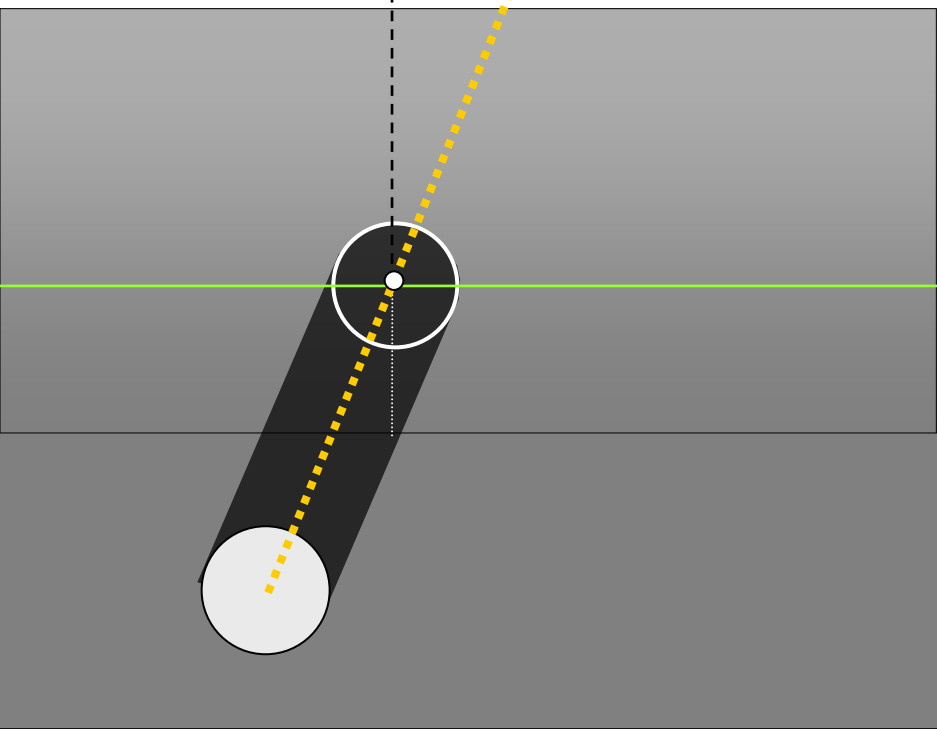
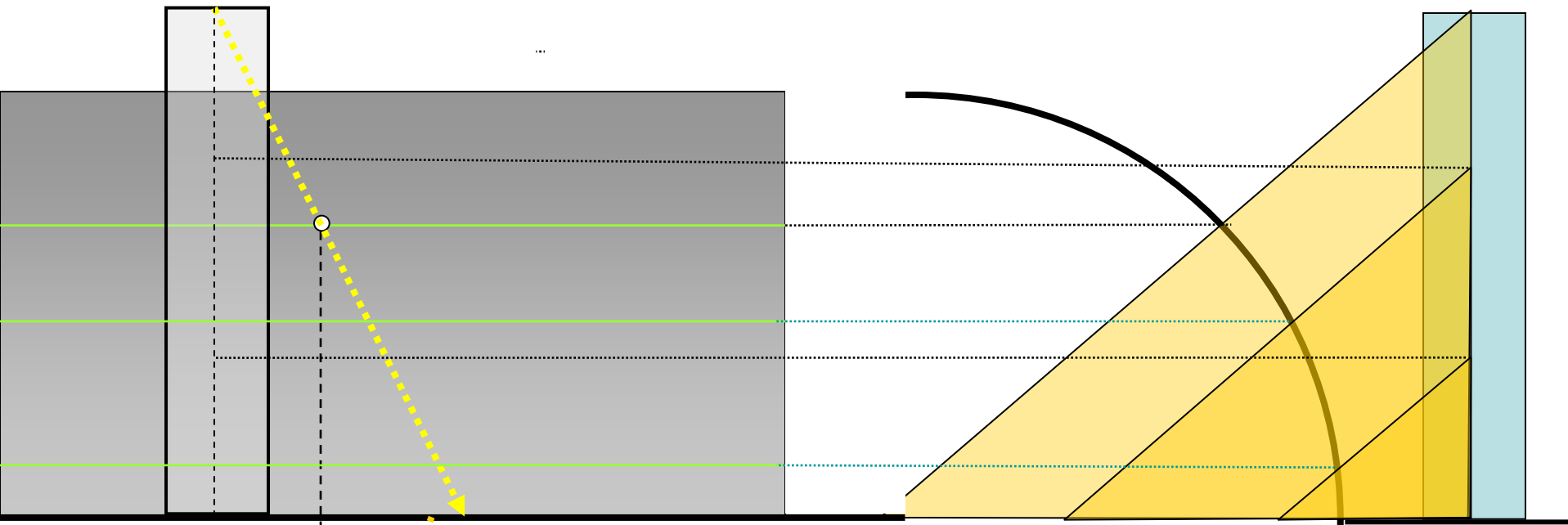

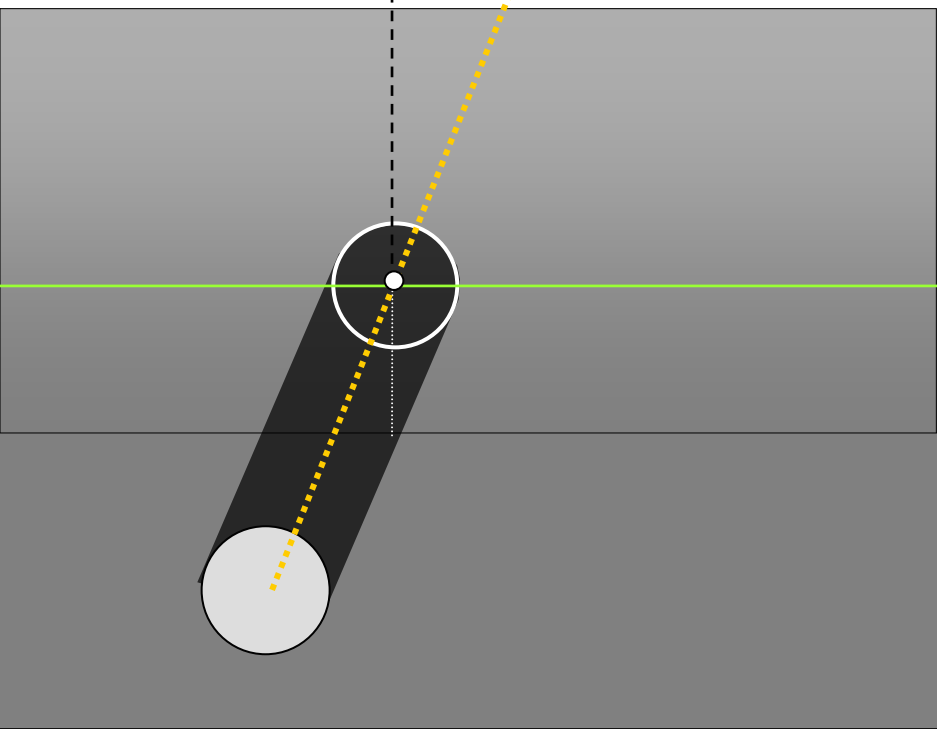
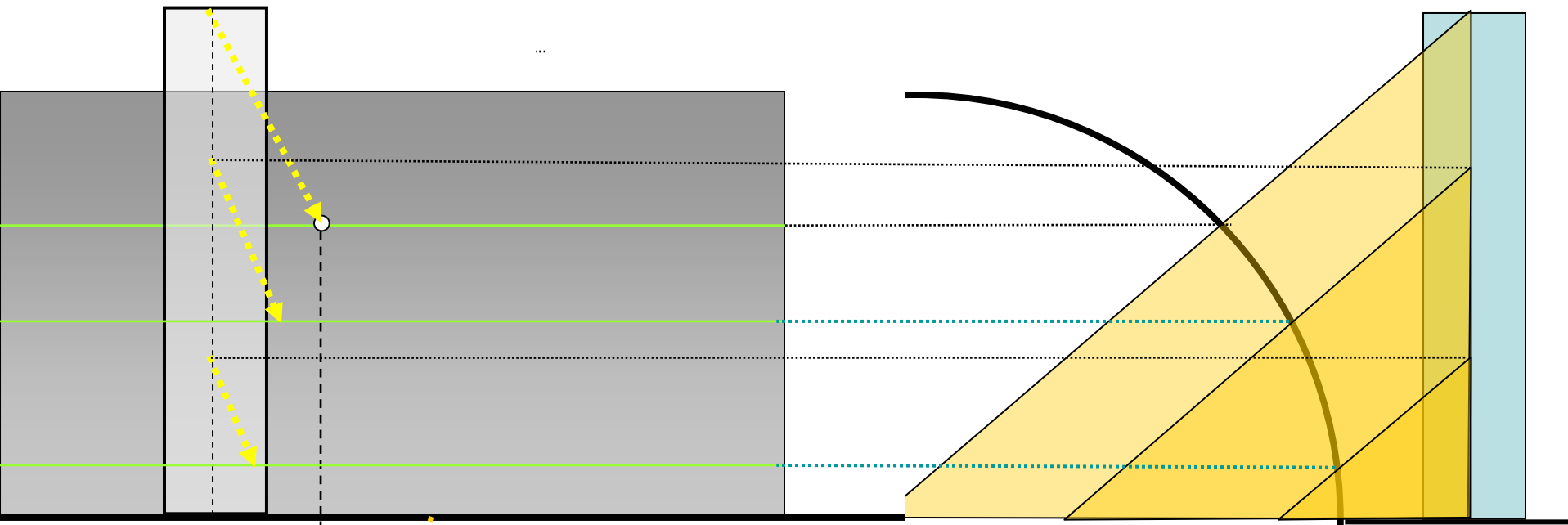

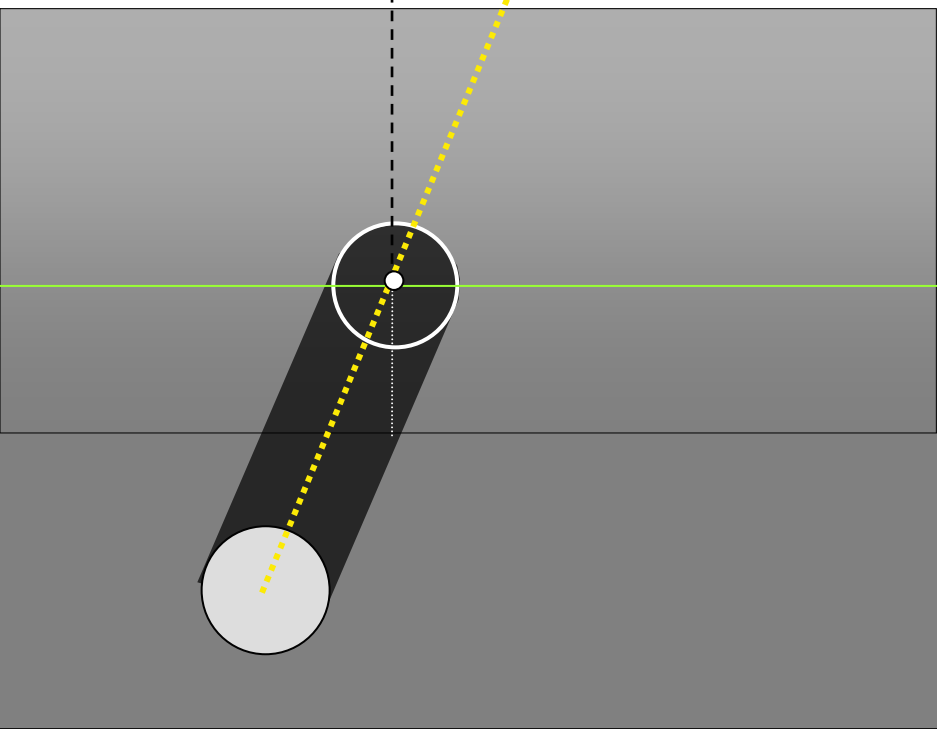
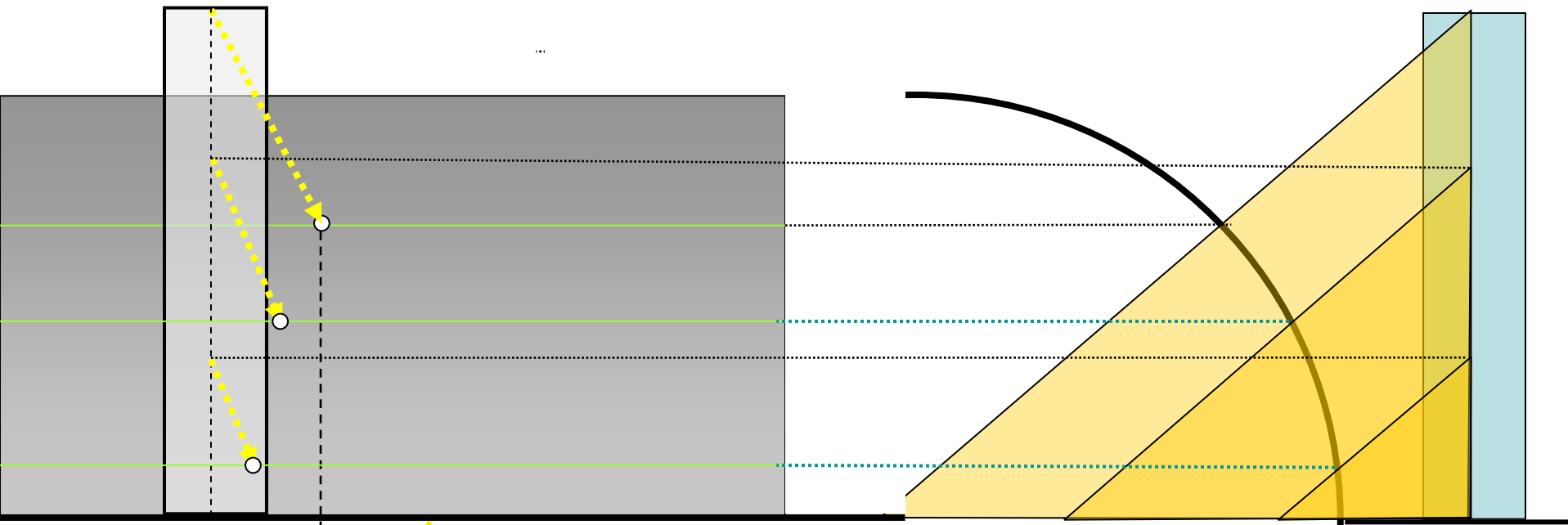

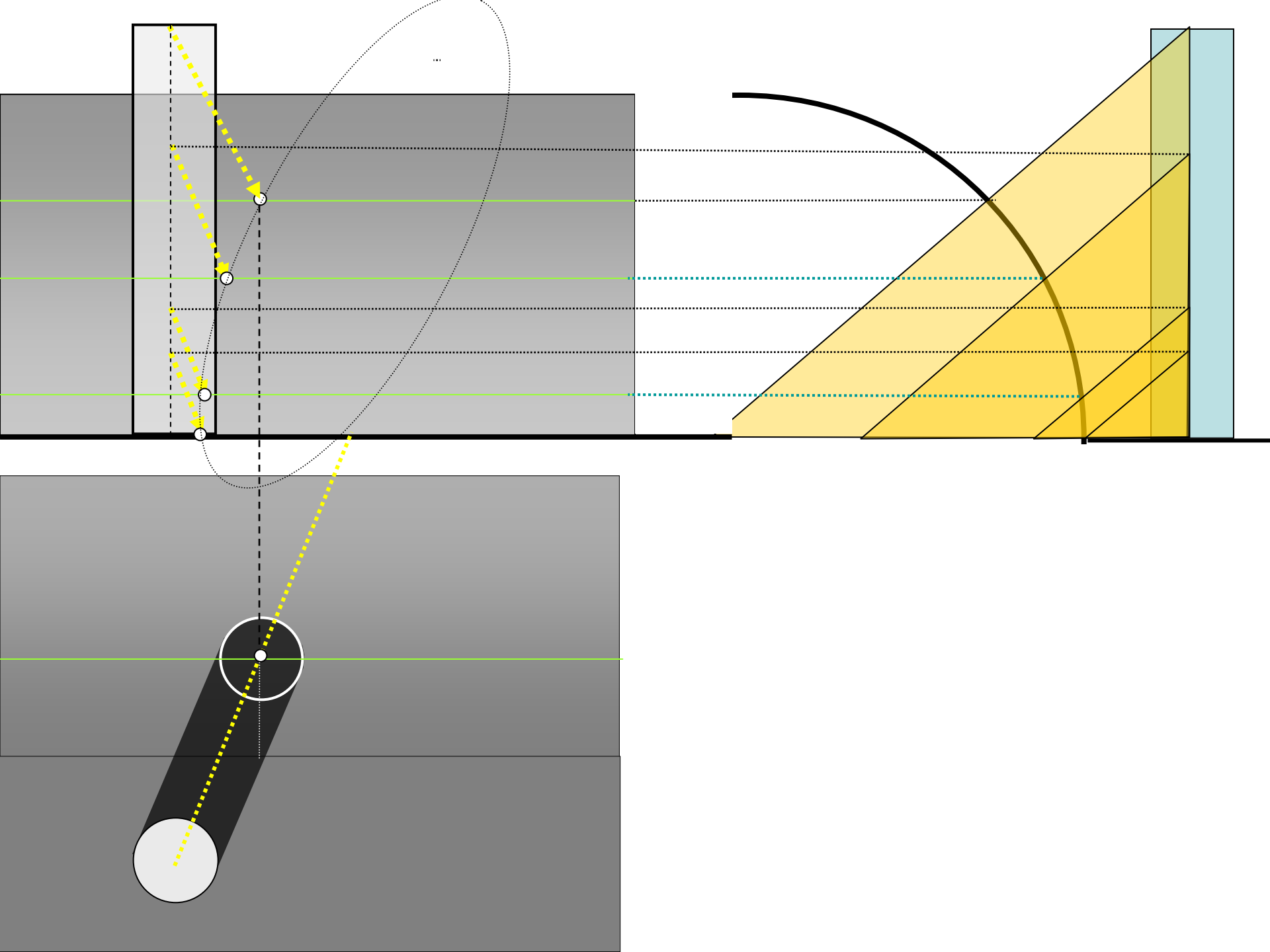

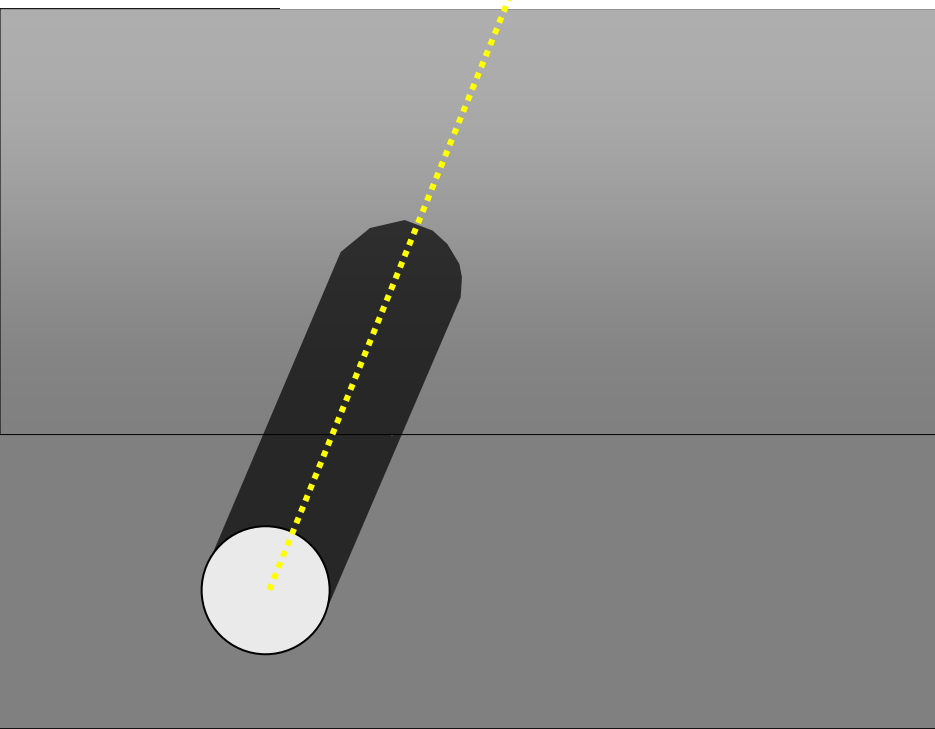
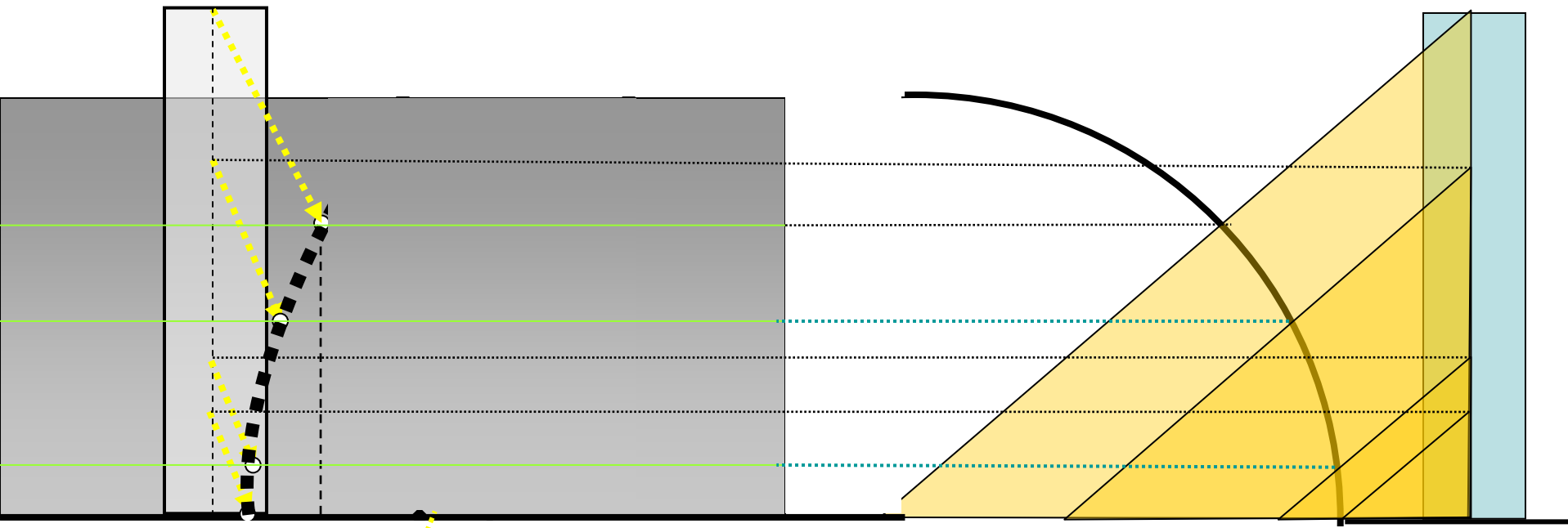

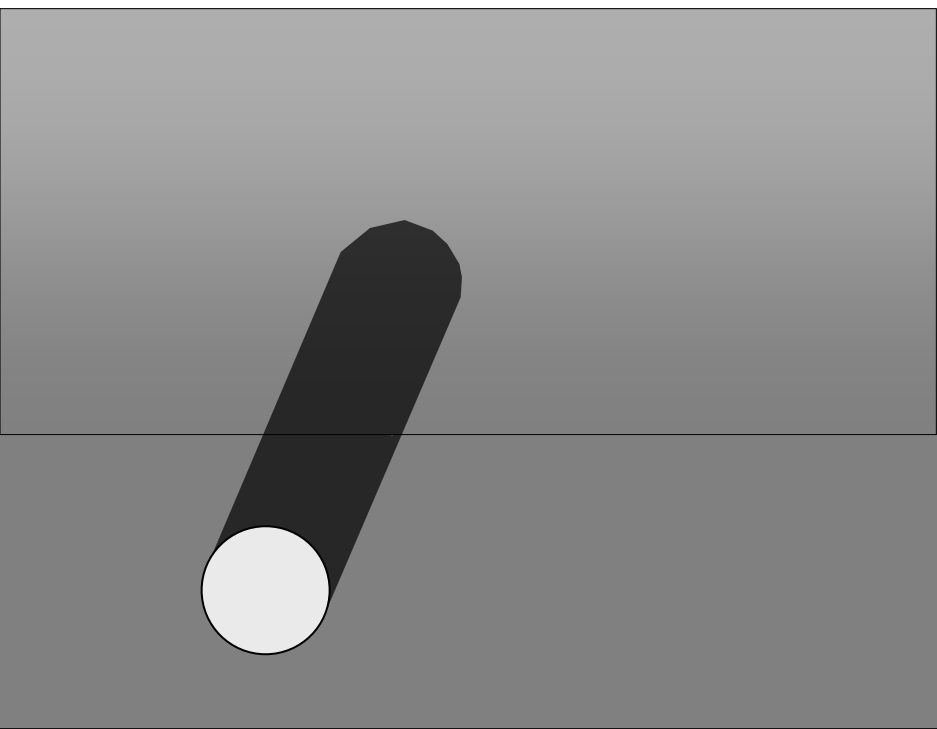
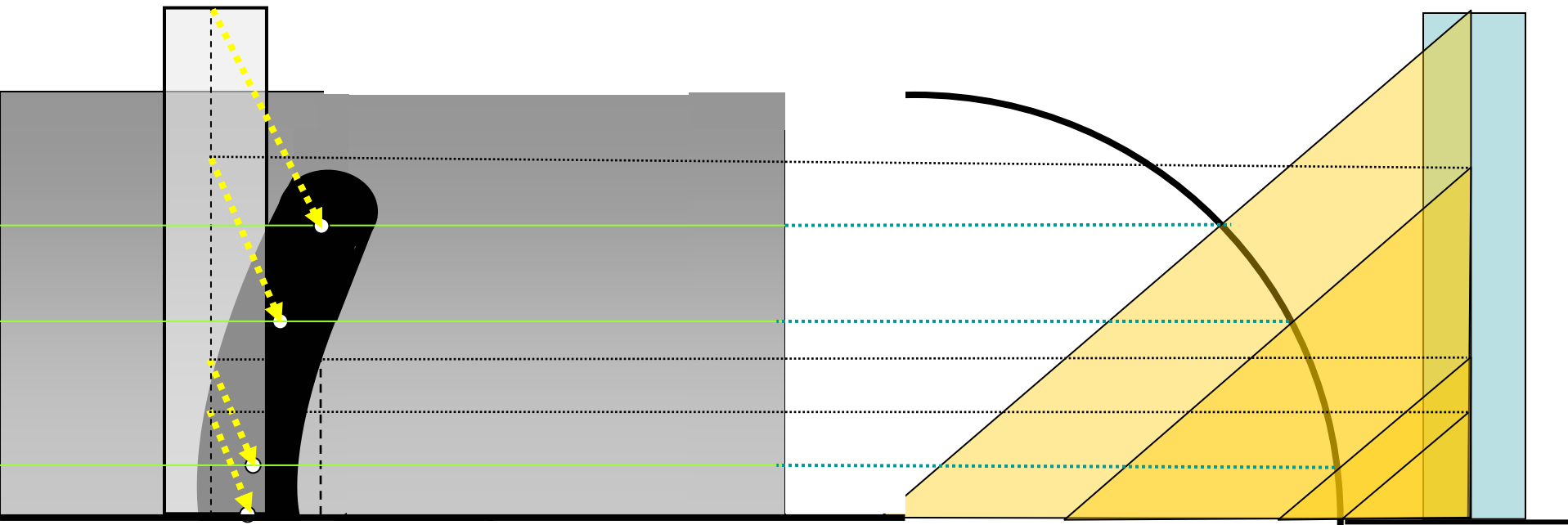

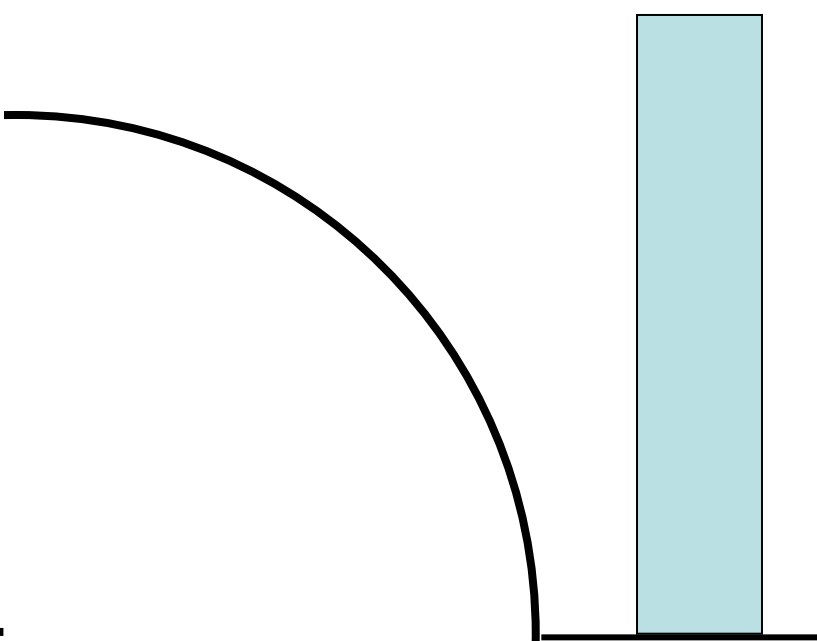
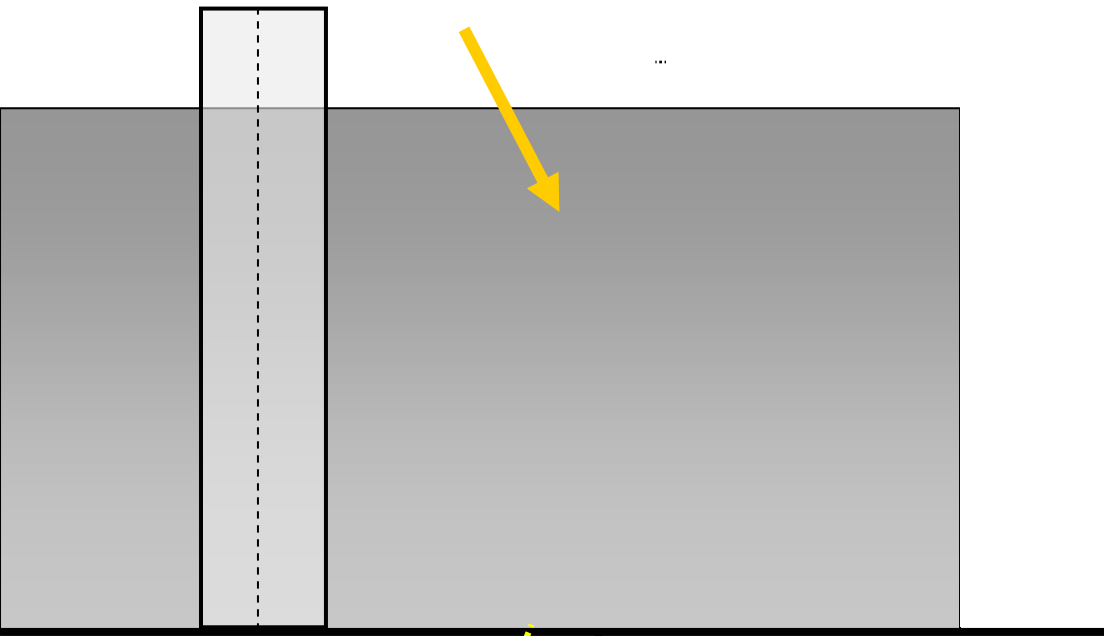

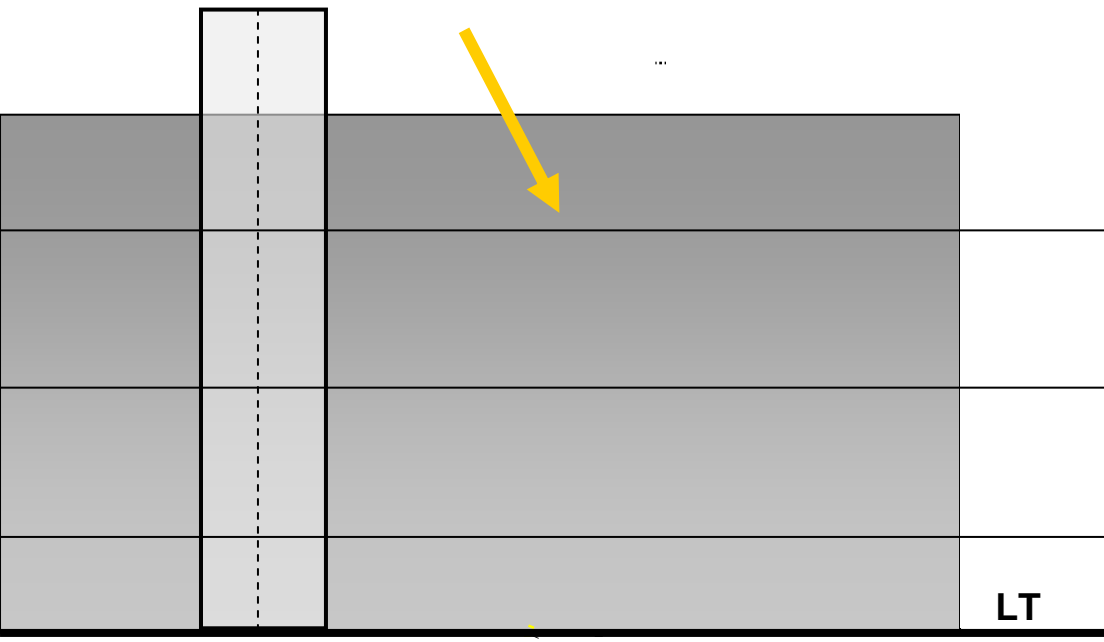

VISTA FRONTAL

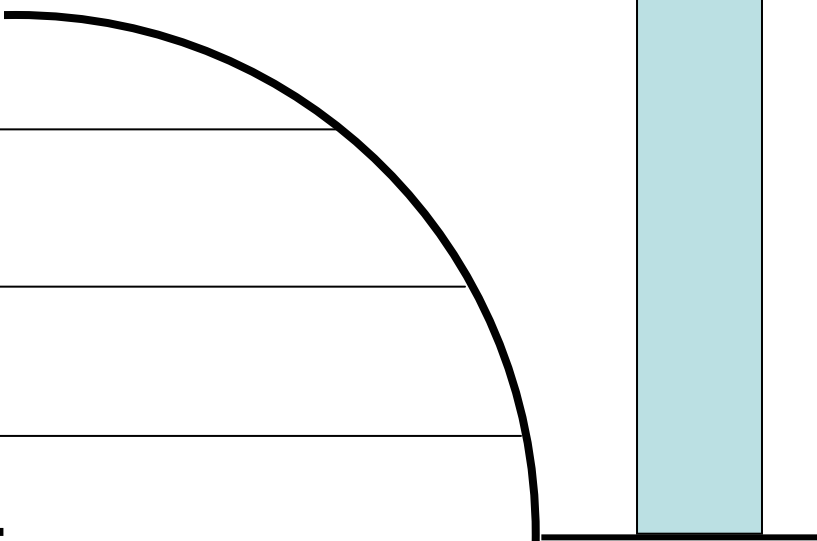

VISTA LATERAL

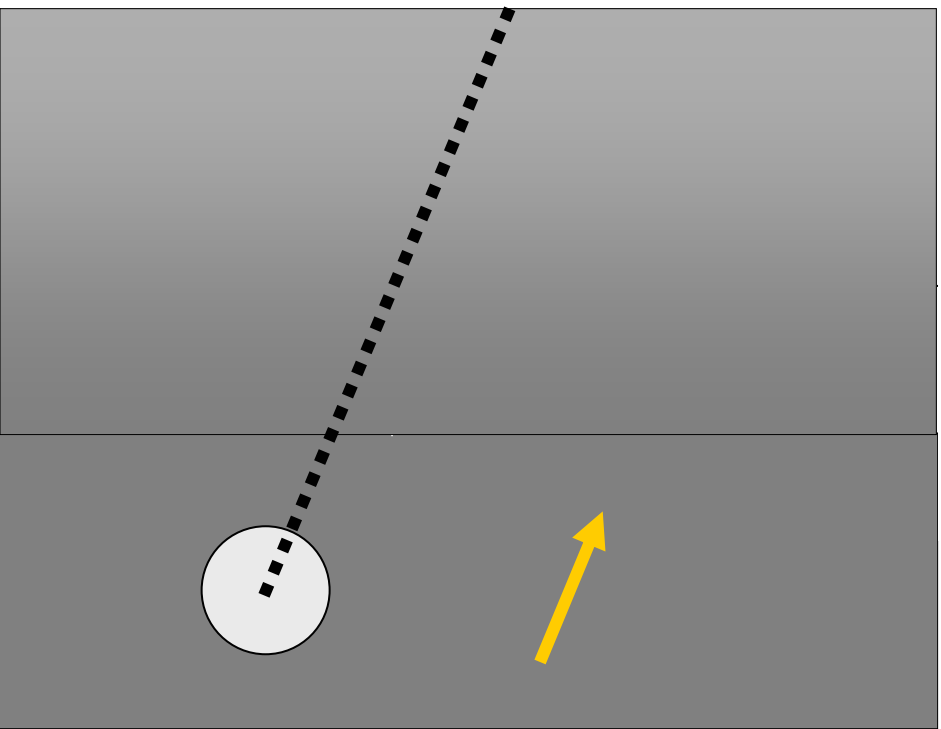

PLANTA

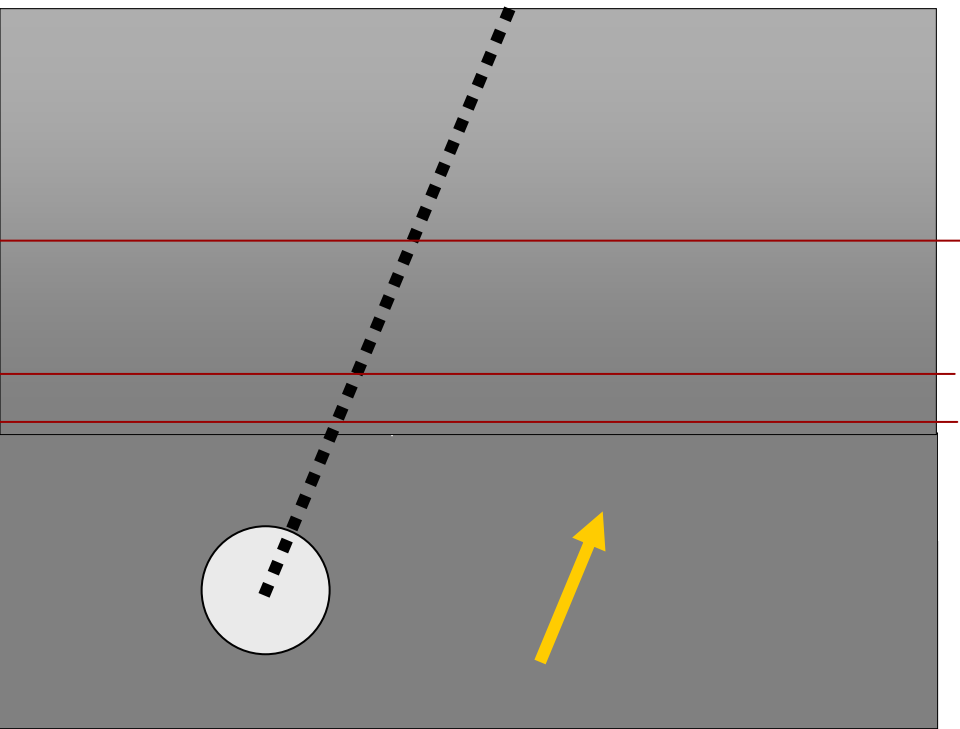
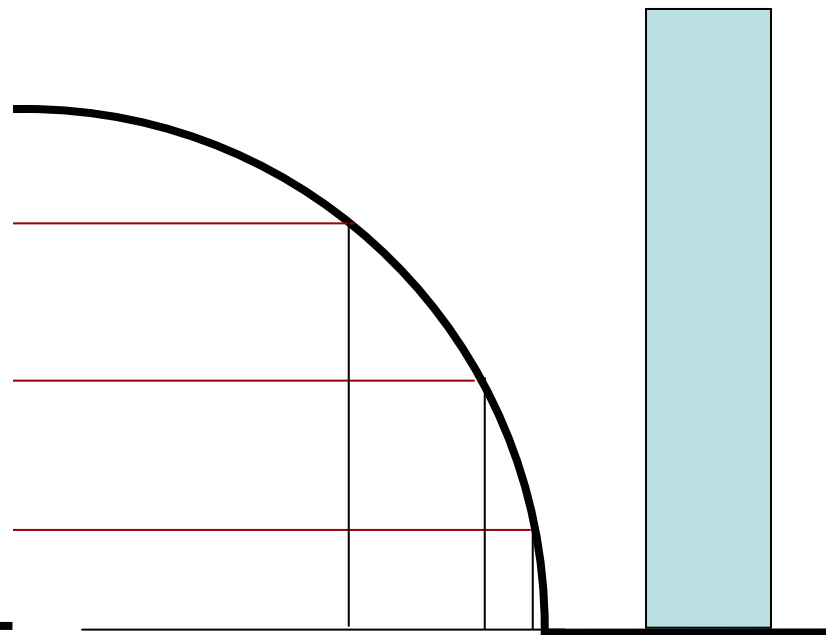
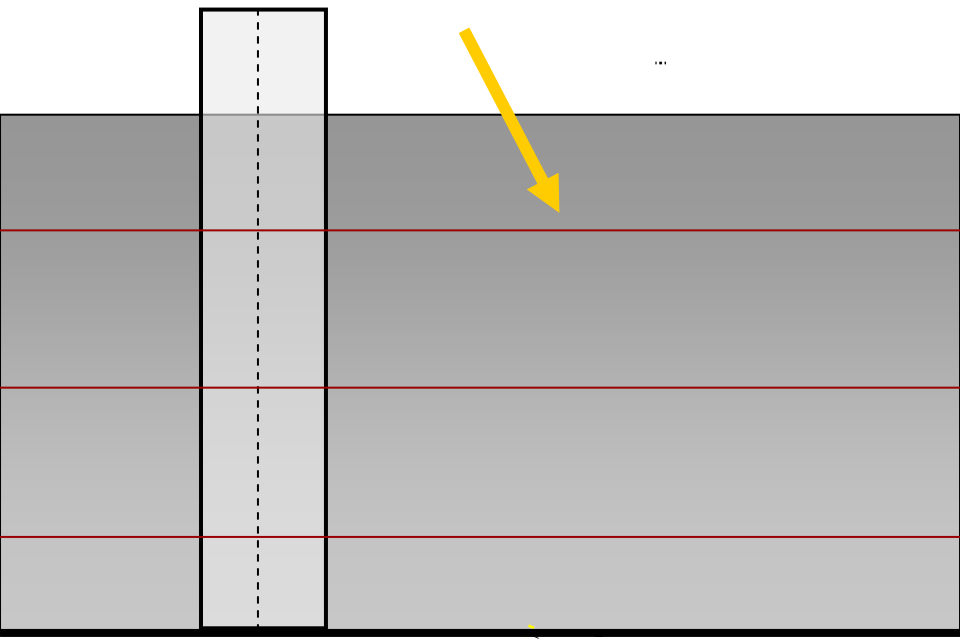

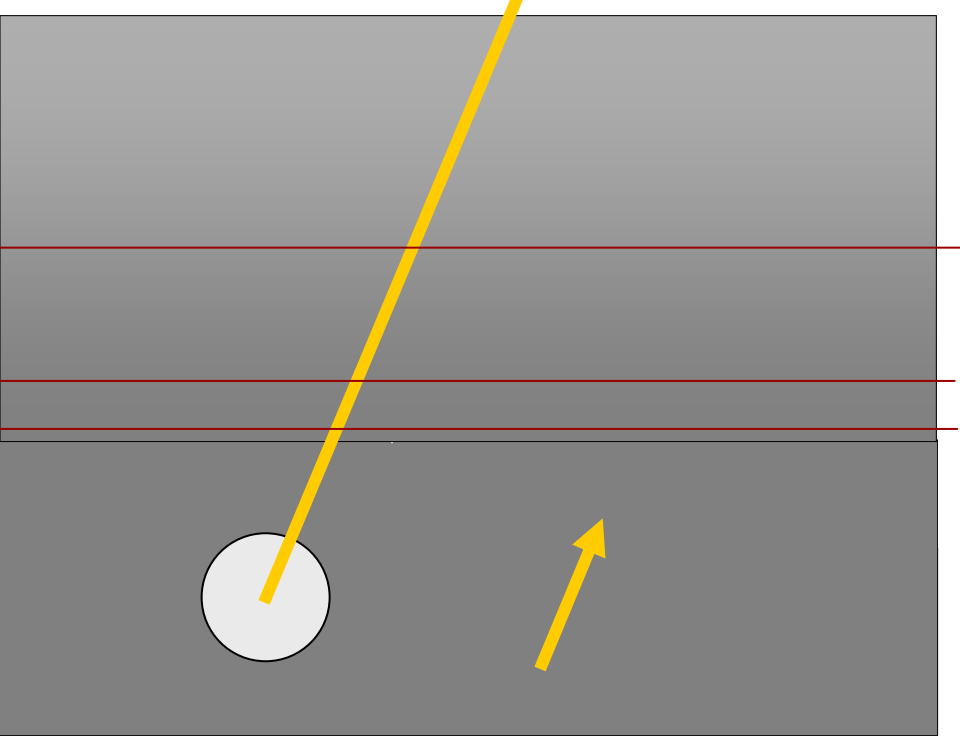
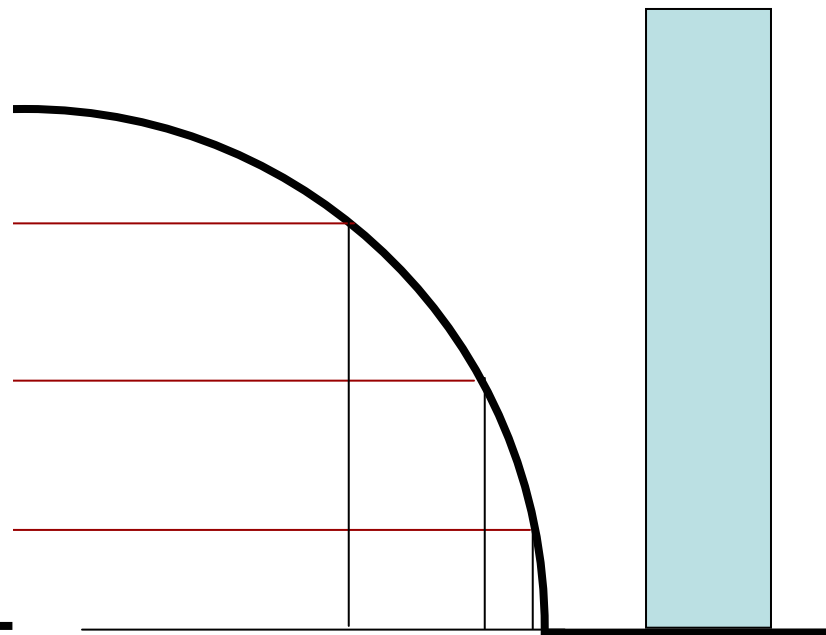
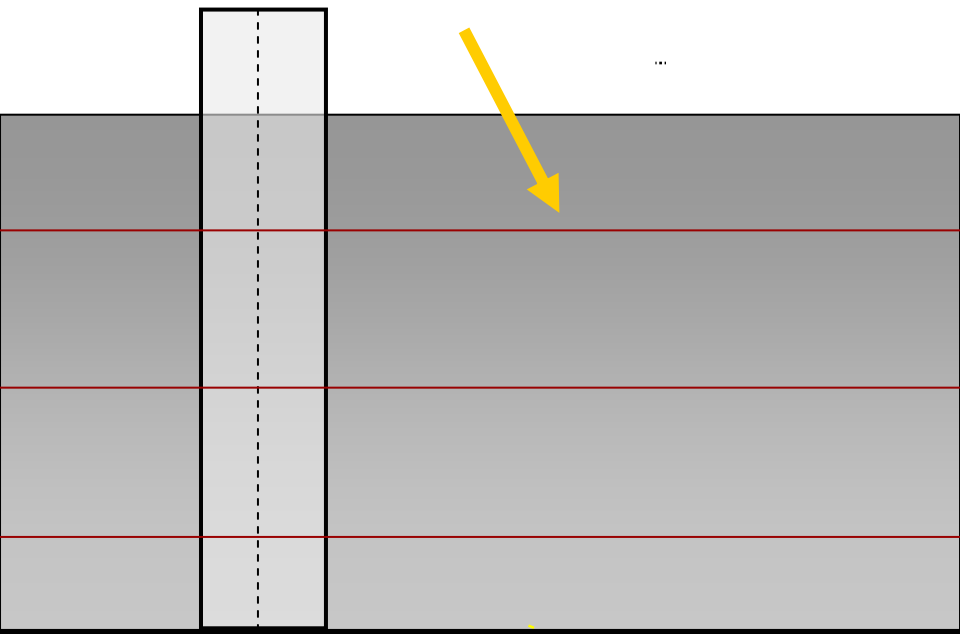

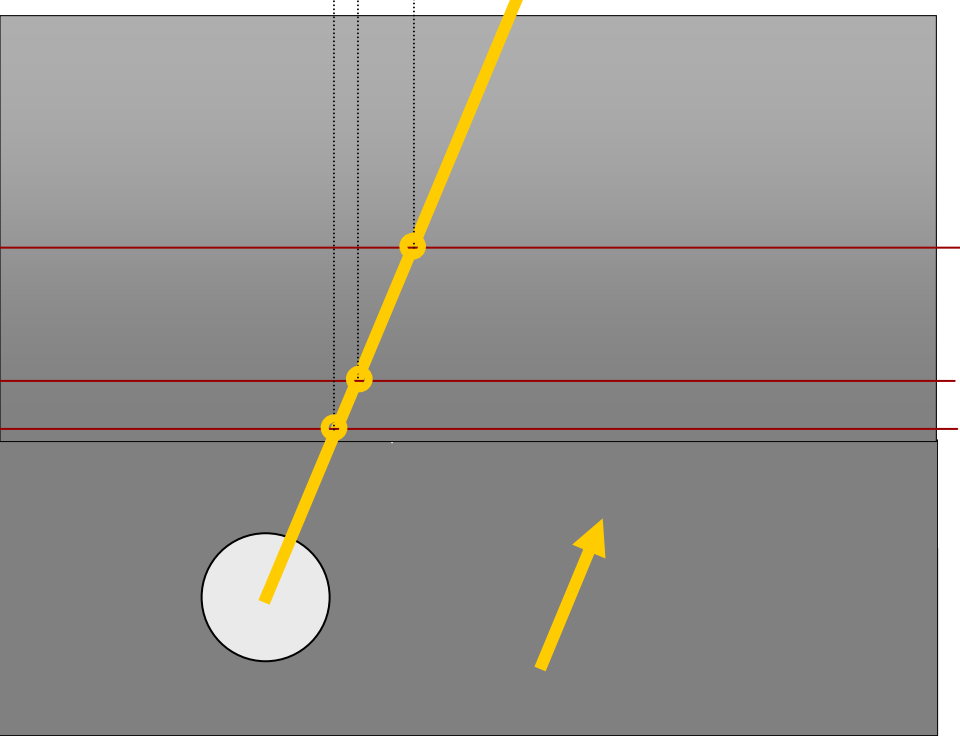
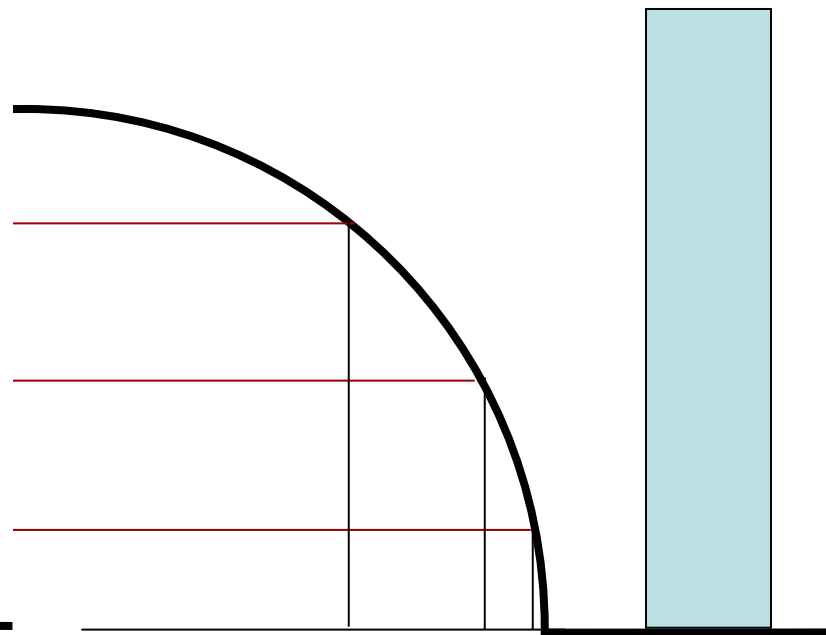
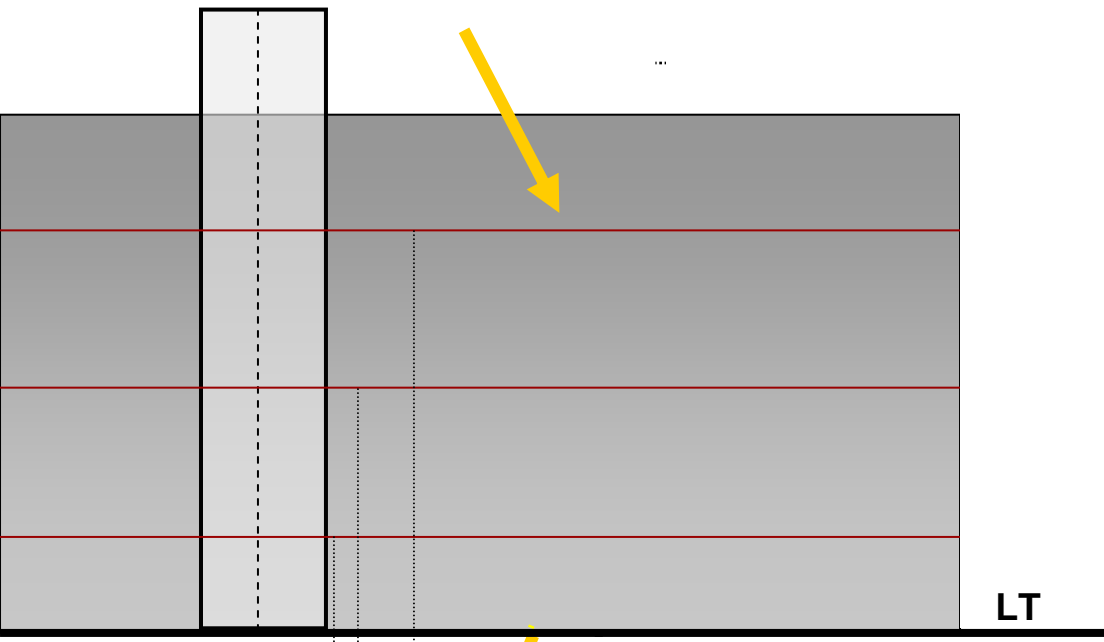

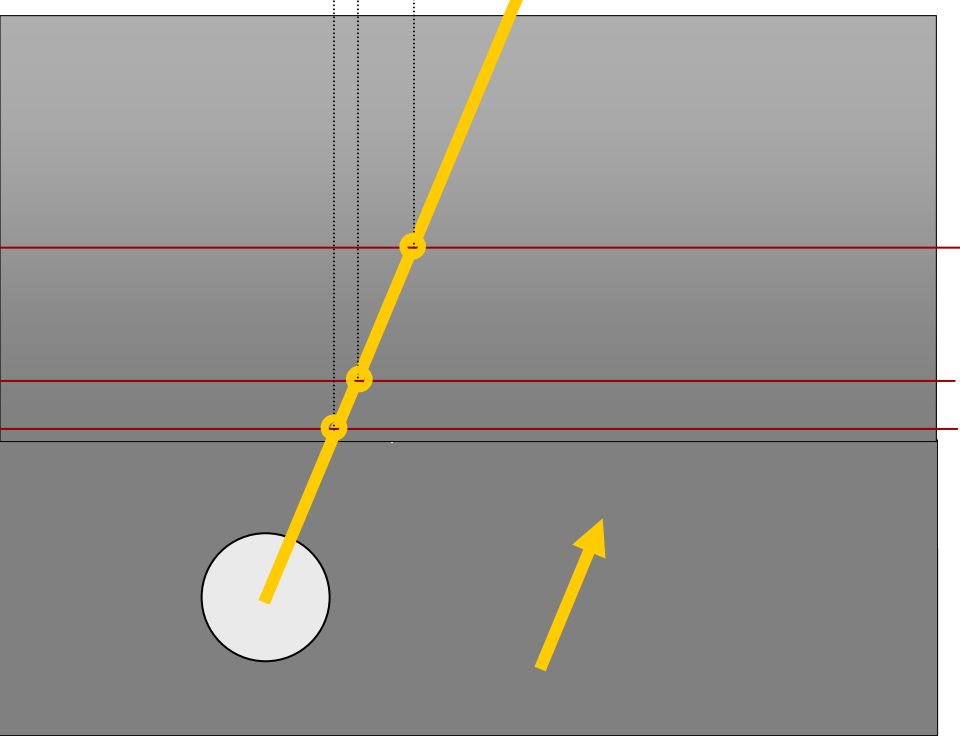
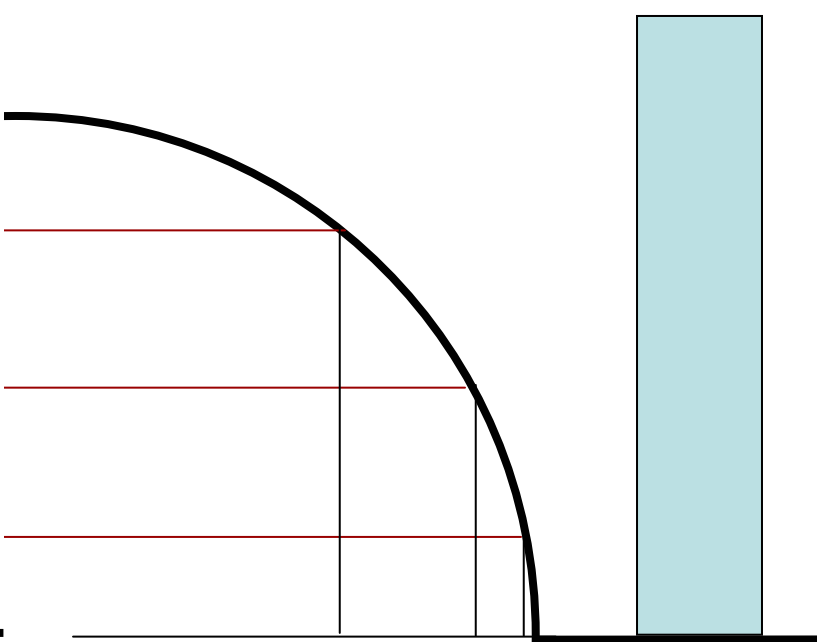
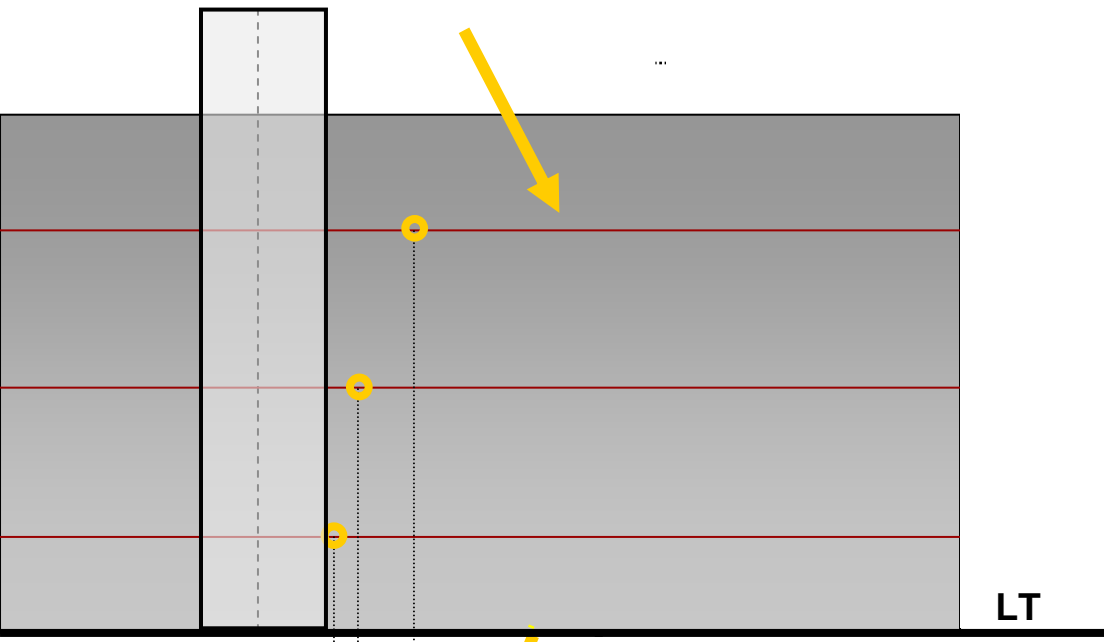

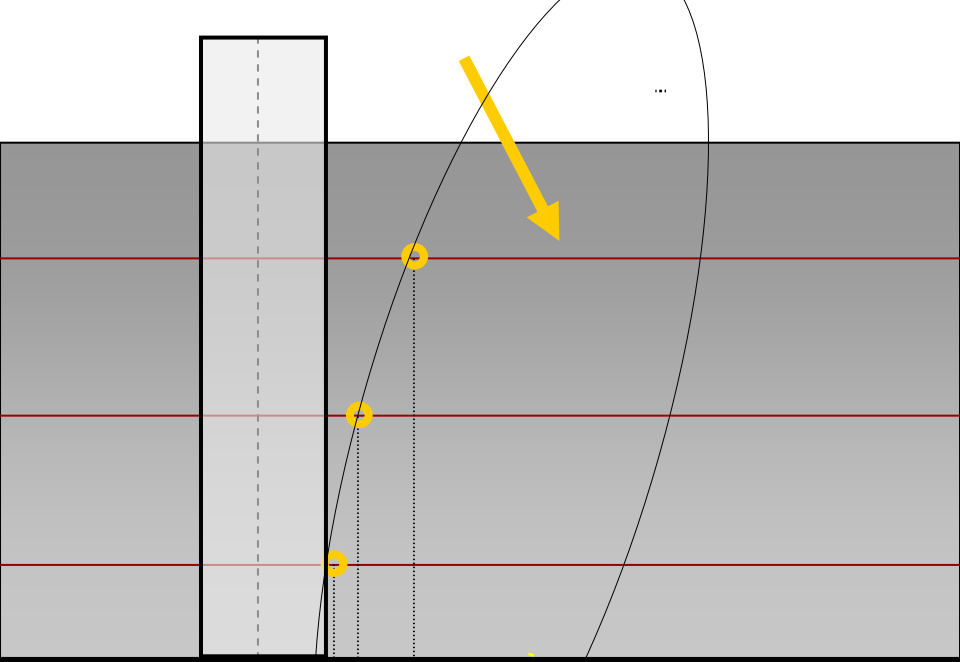

LT

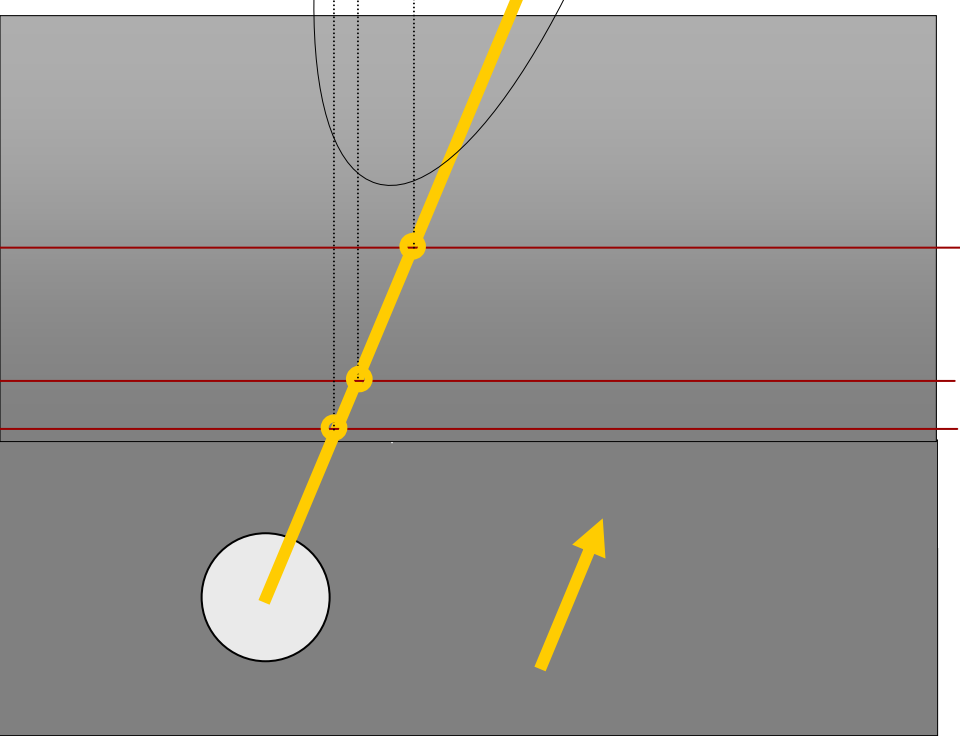
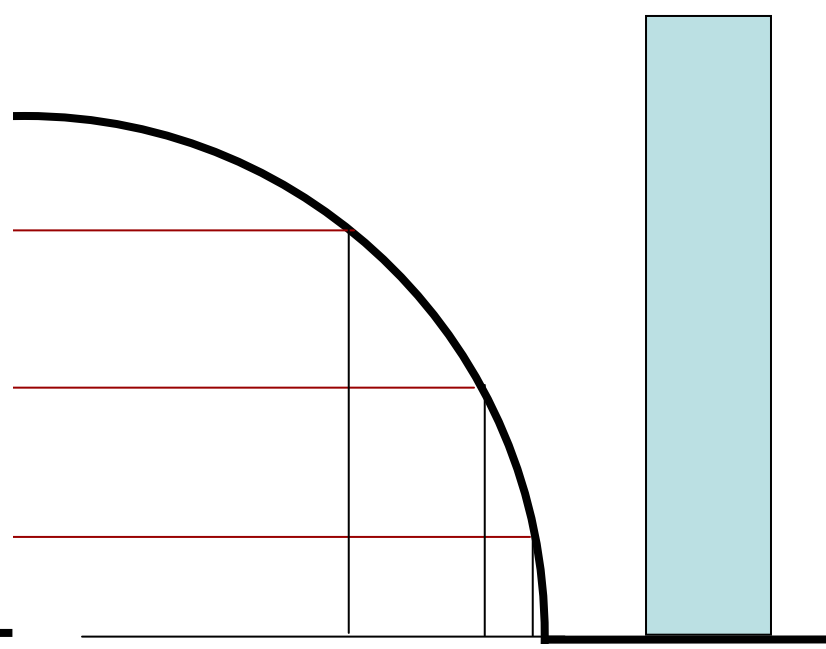

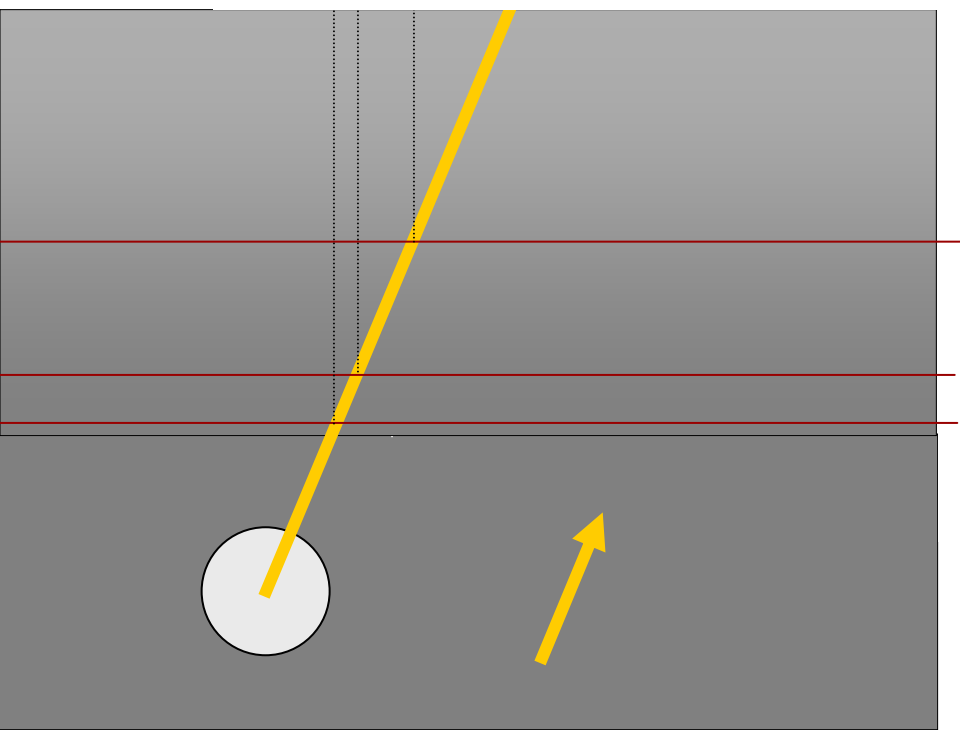
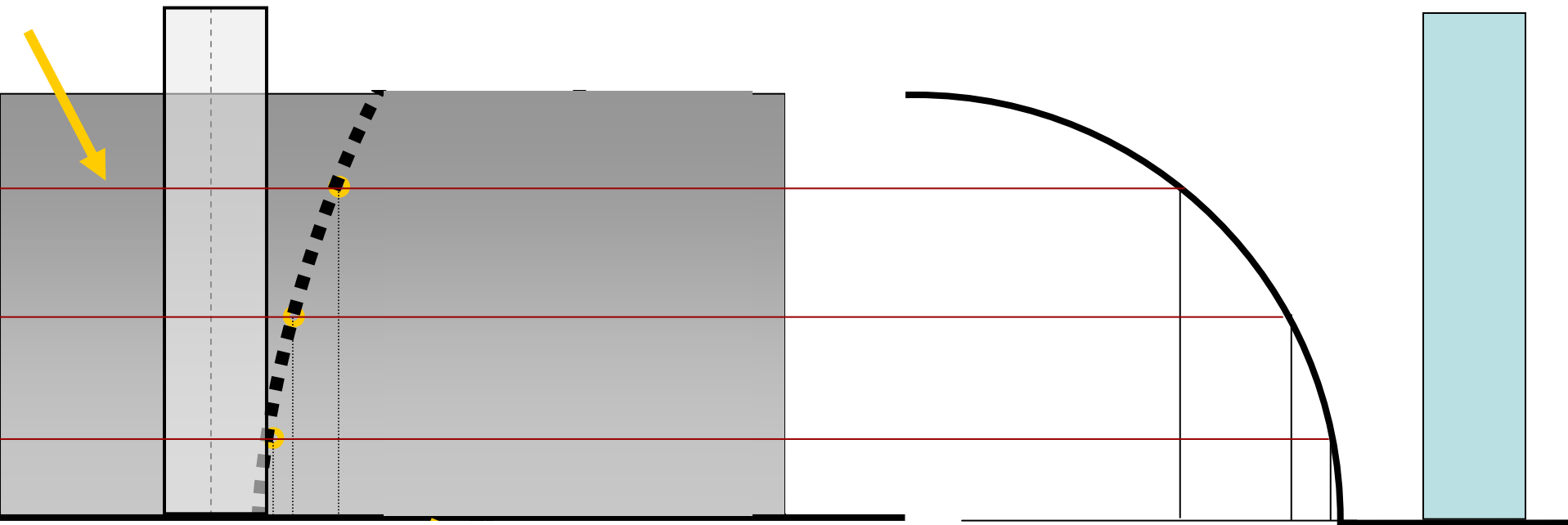

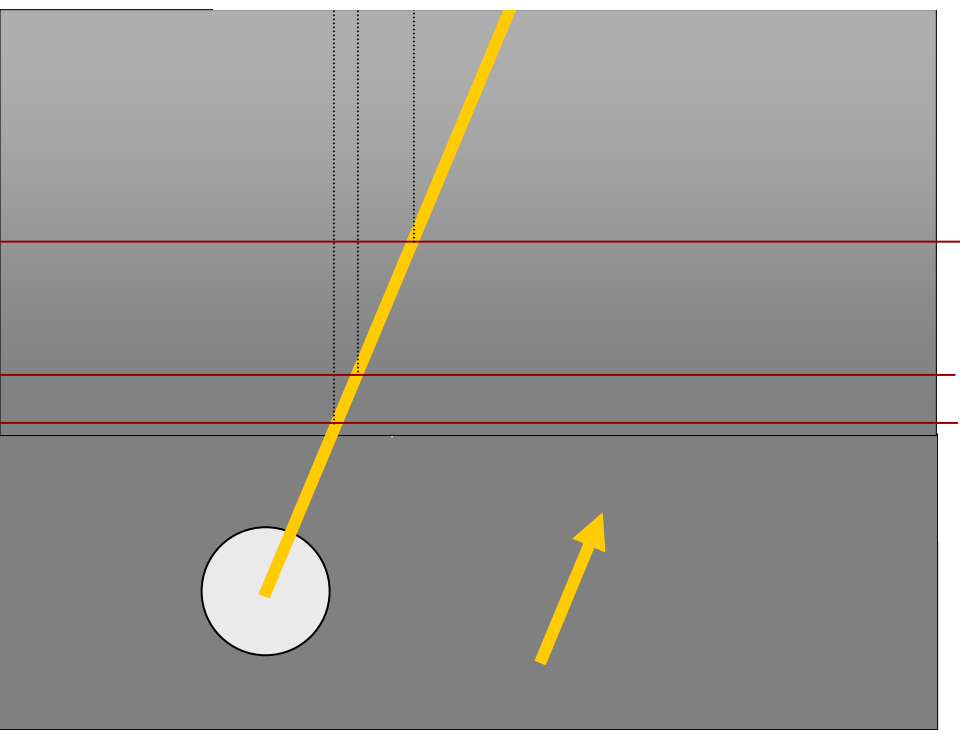
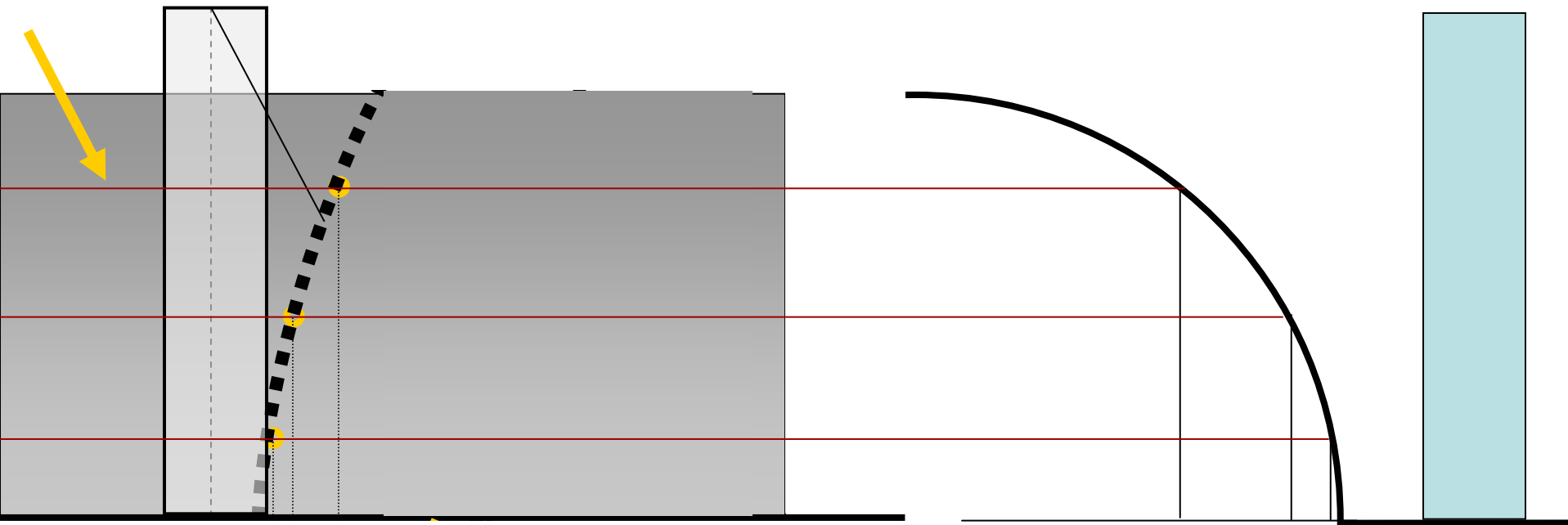

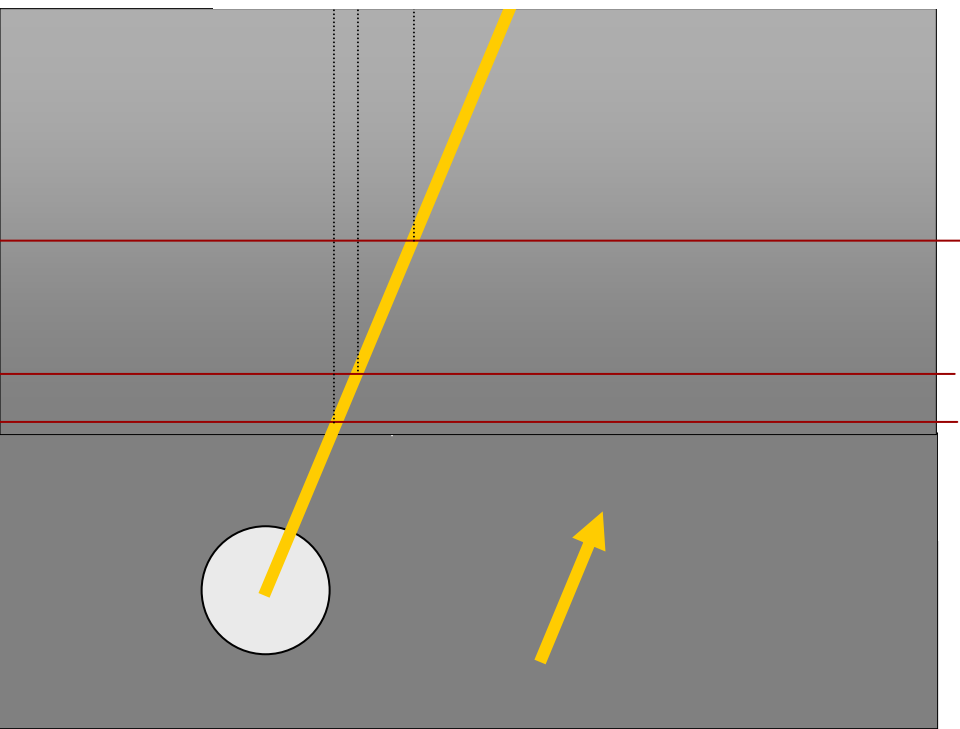
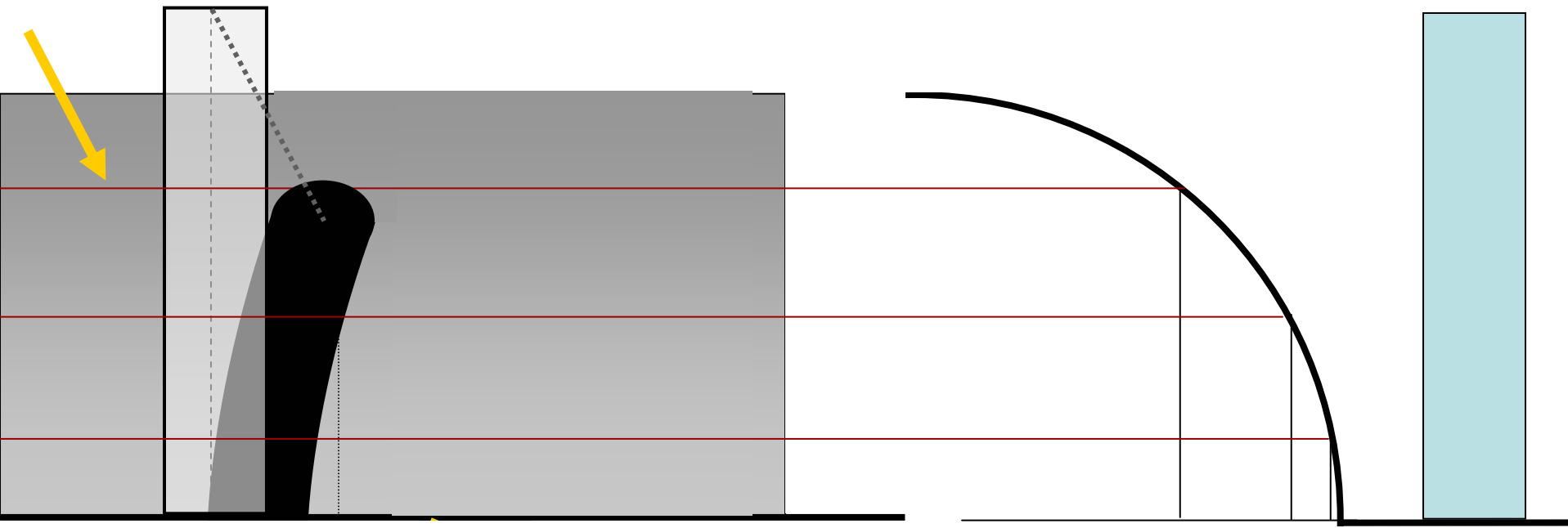

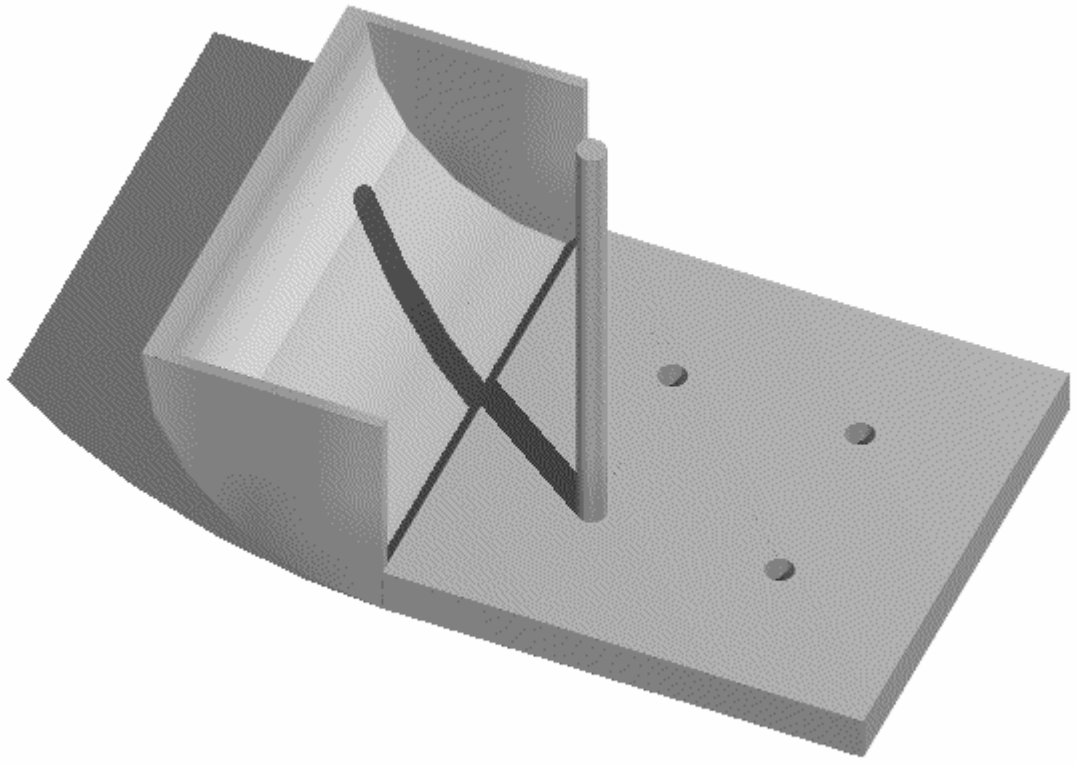

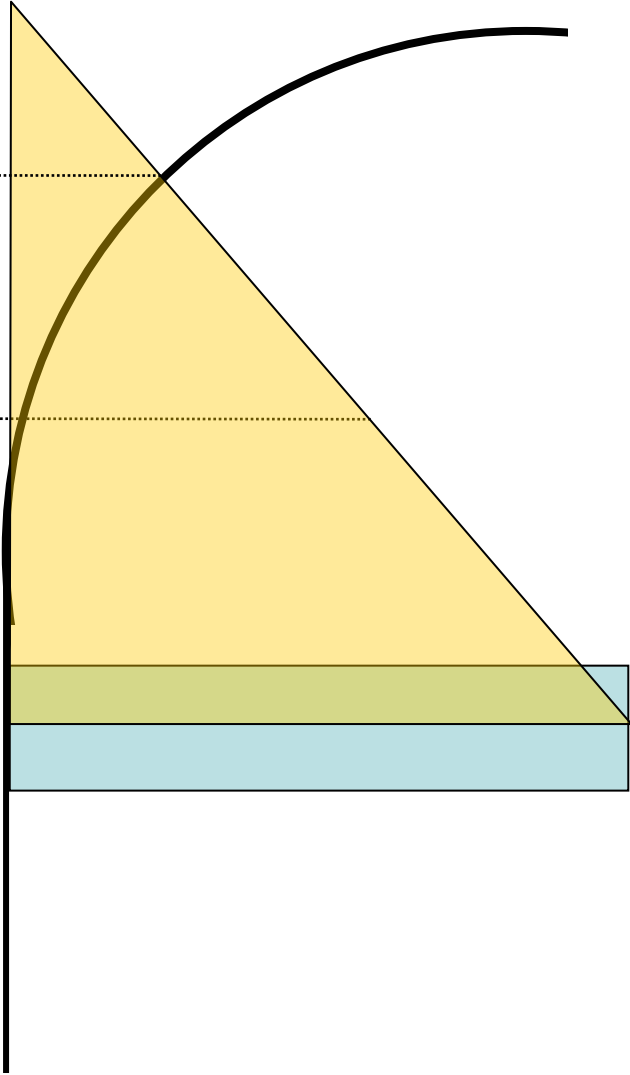
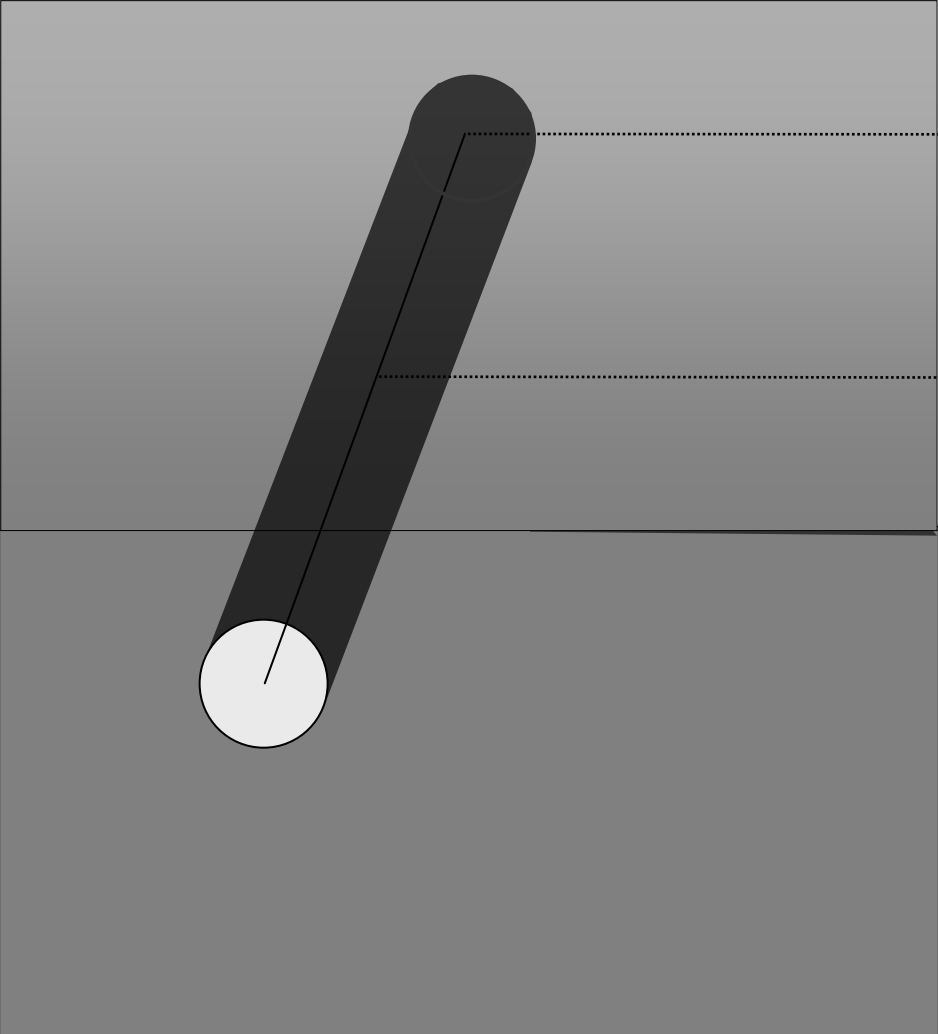

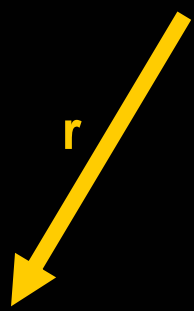
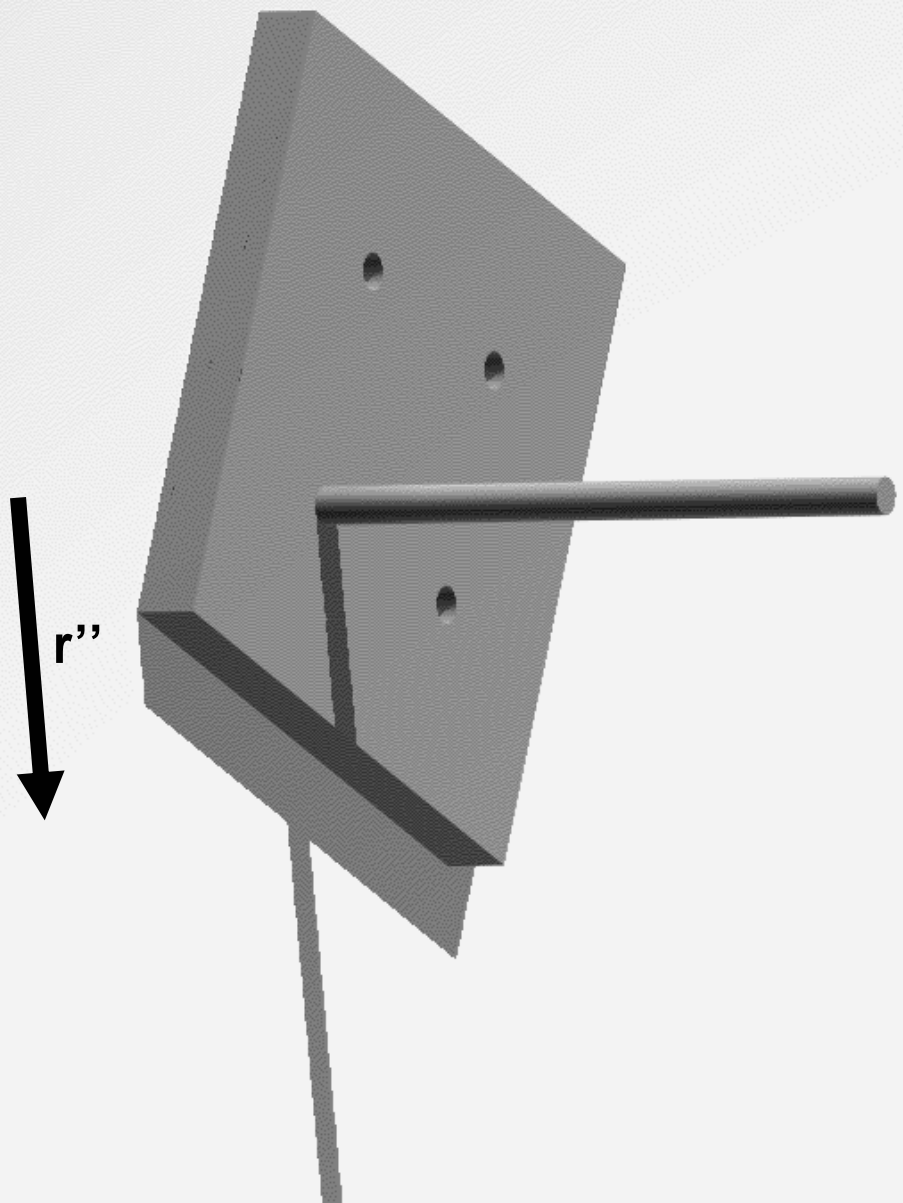

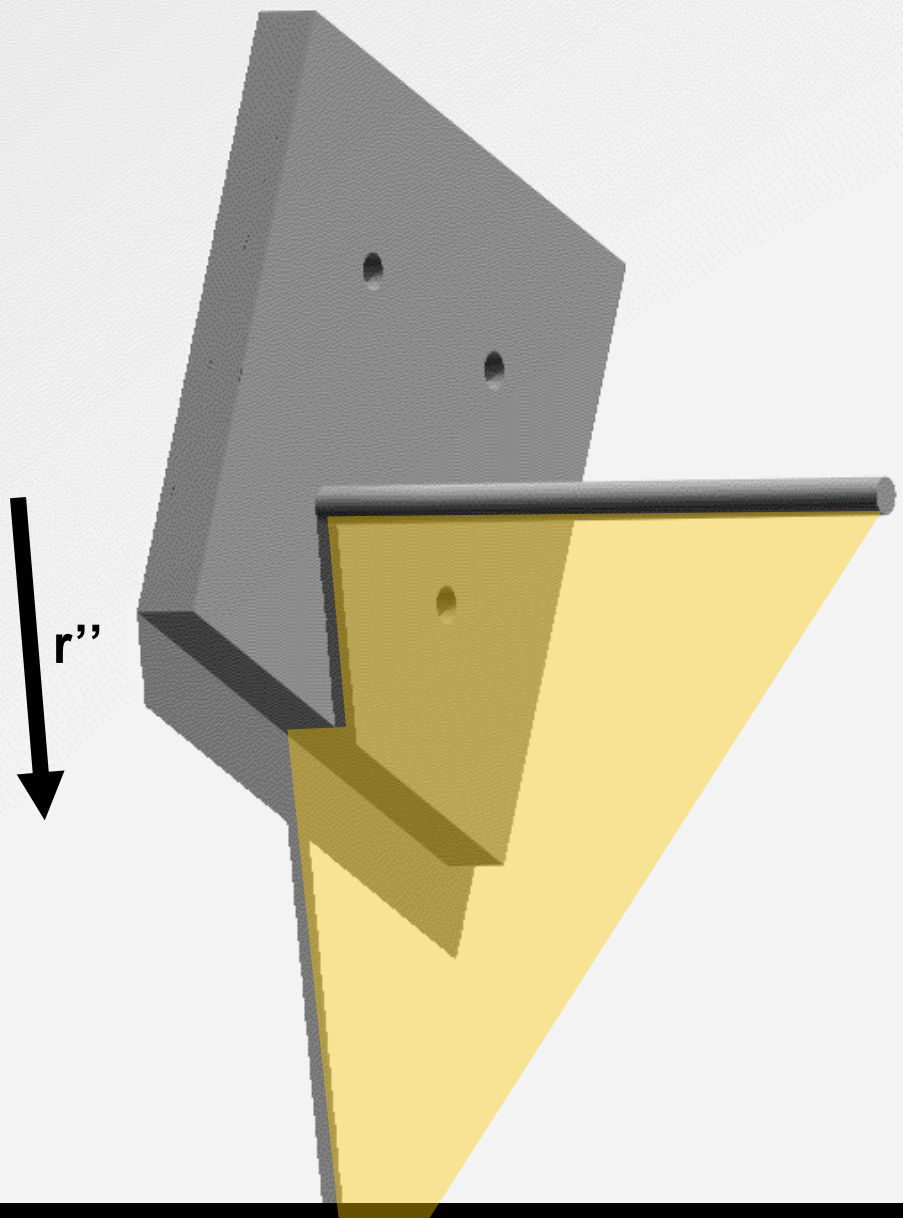

r''

r

r''

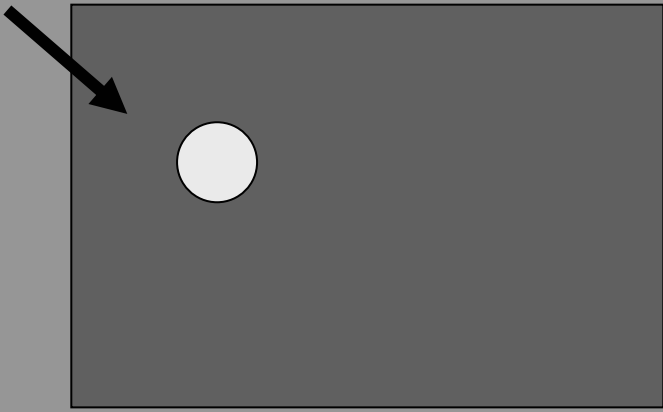

FACHADA

LT (PISO)

PLANTA

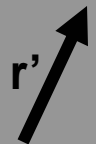

PARED

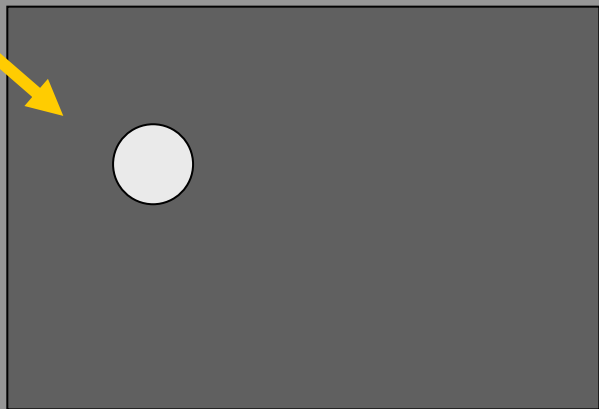

FACHADA

LT (PISO)



PLANTA

PARED

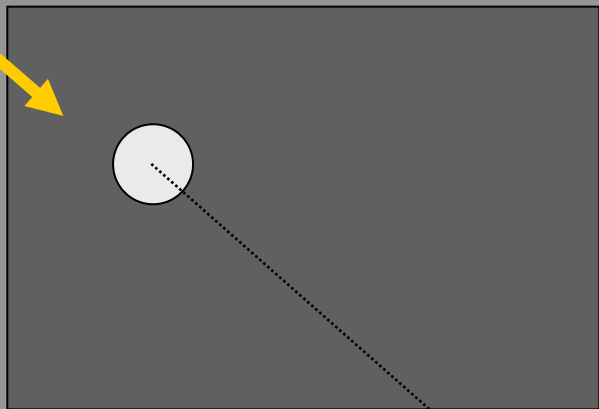

FACHADA

LT (PISO)



PLANTA

PARED

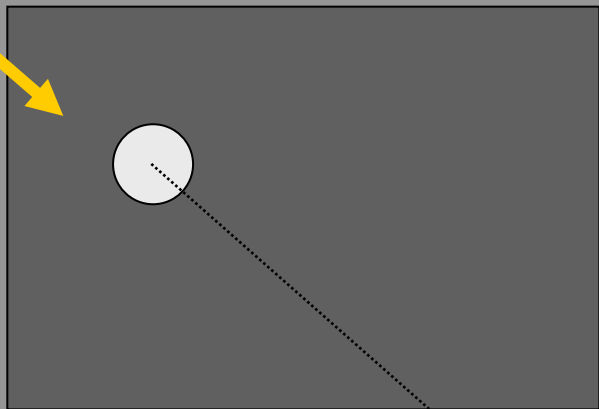

FACHADA

LT (PISO)

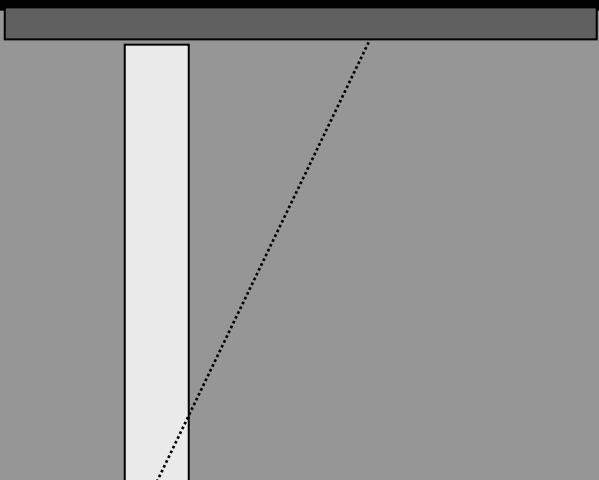

PLANTA

PARED

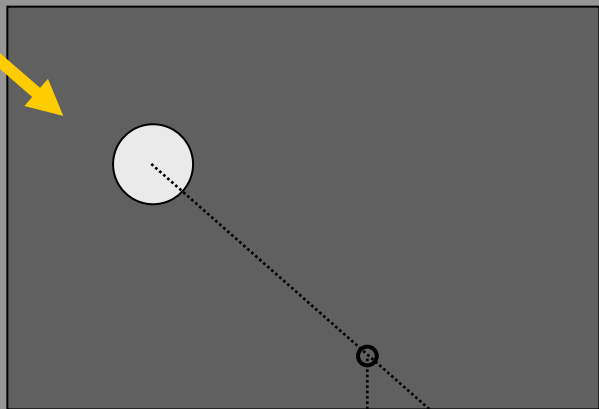

FACHADA

LT (PISO)

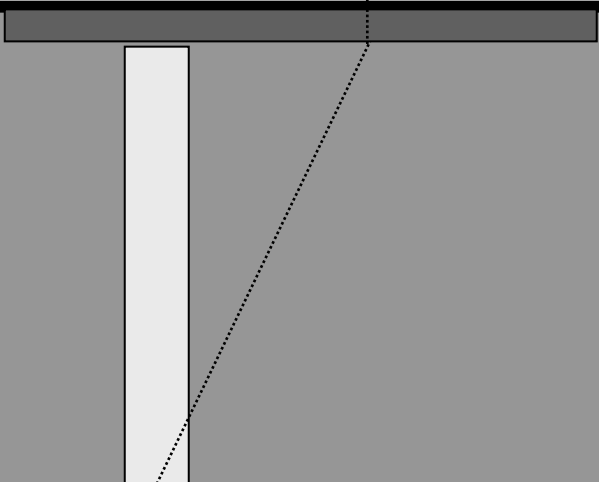

PLANTA

PARED

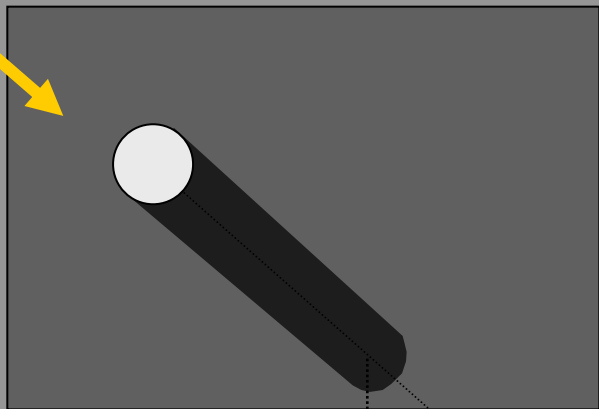

FACHADA

LT (PISO)

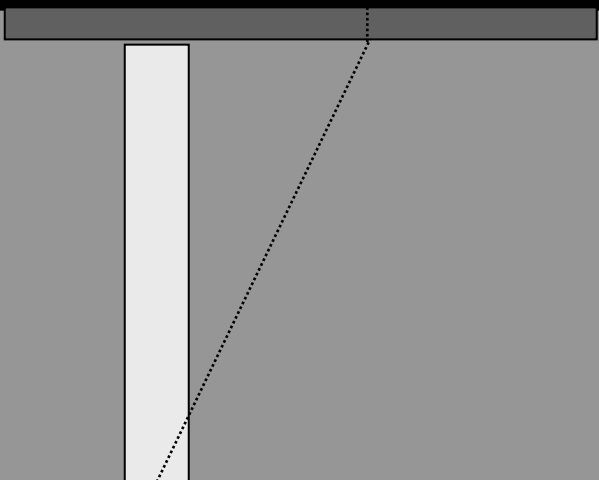

PLANTA

PARED

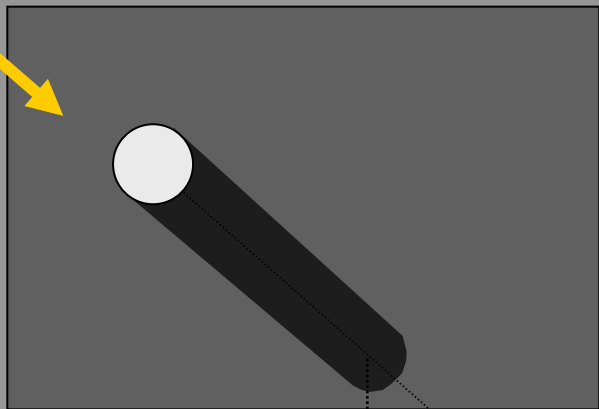

FACHADA

LT (PISO)

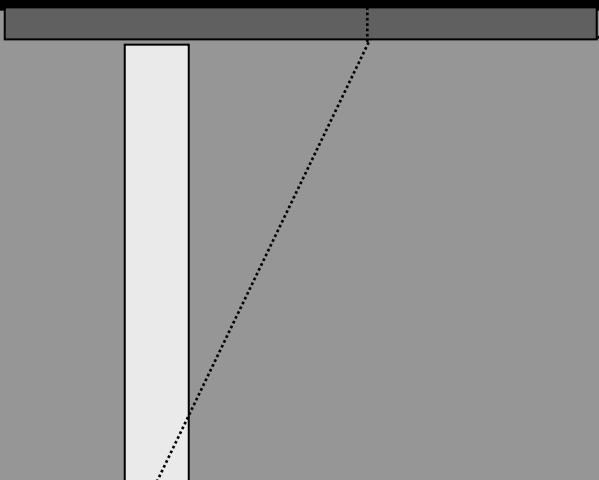

PLANTA

PARED

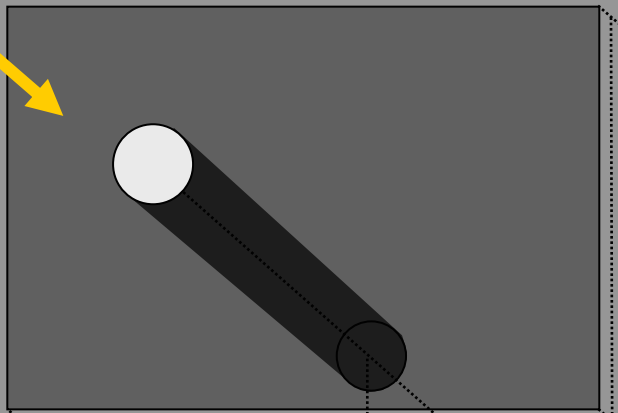

FACHADA

LT (PISO)



PLANTA

PARED

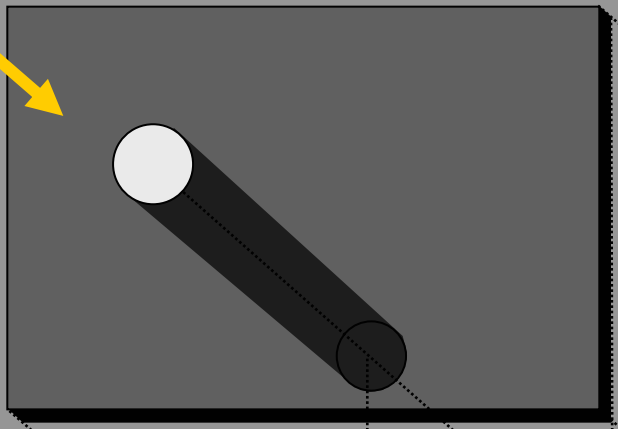

FACHADA

LT (PISO)



PLANTA

PARED

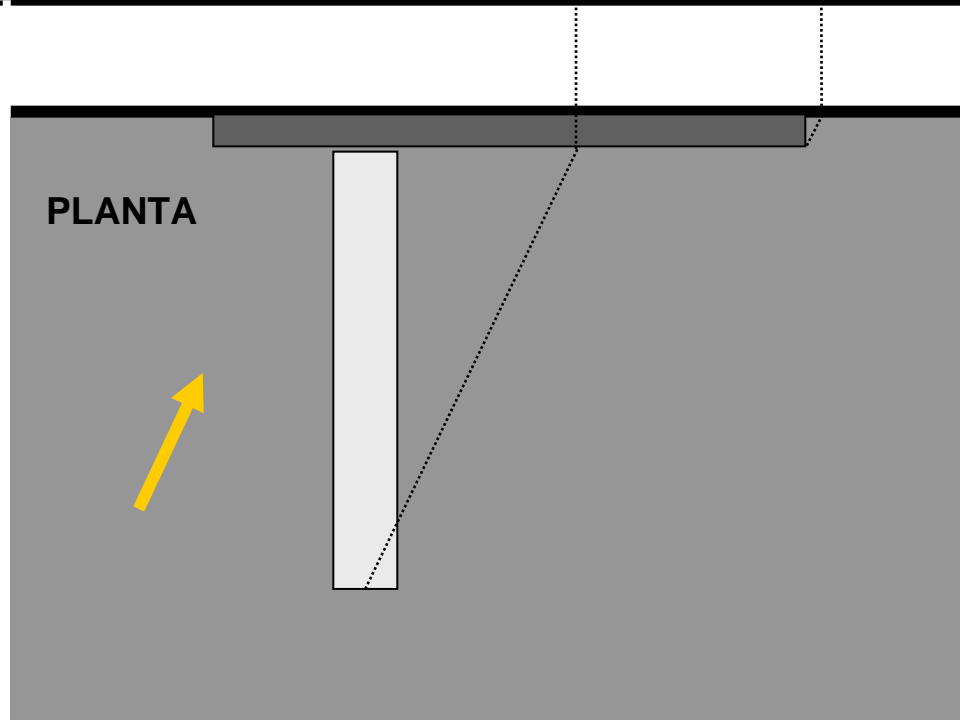
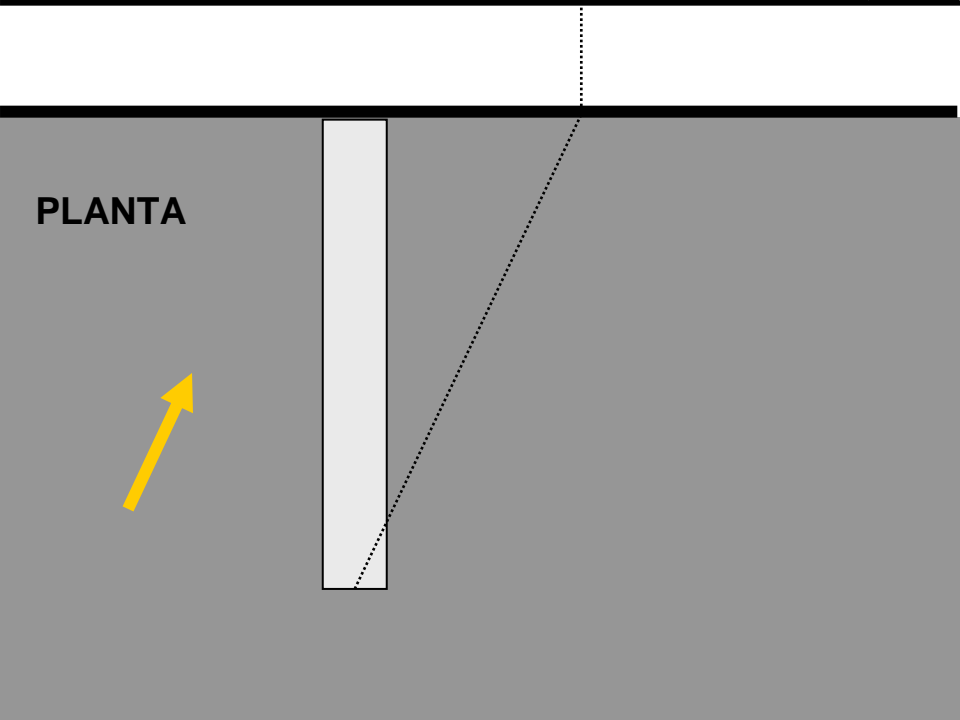
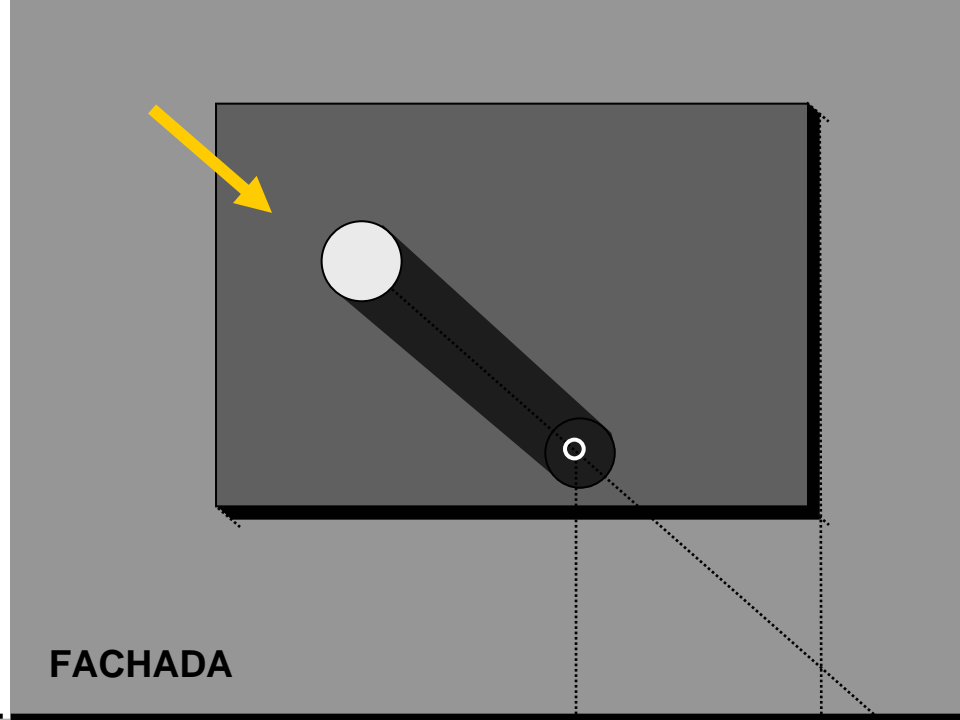
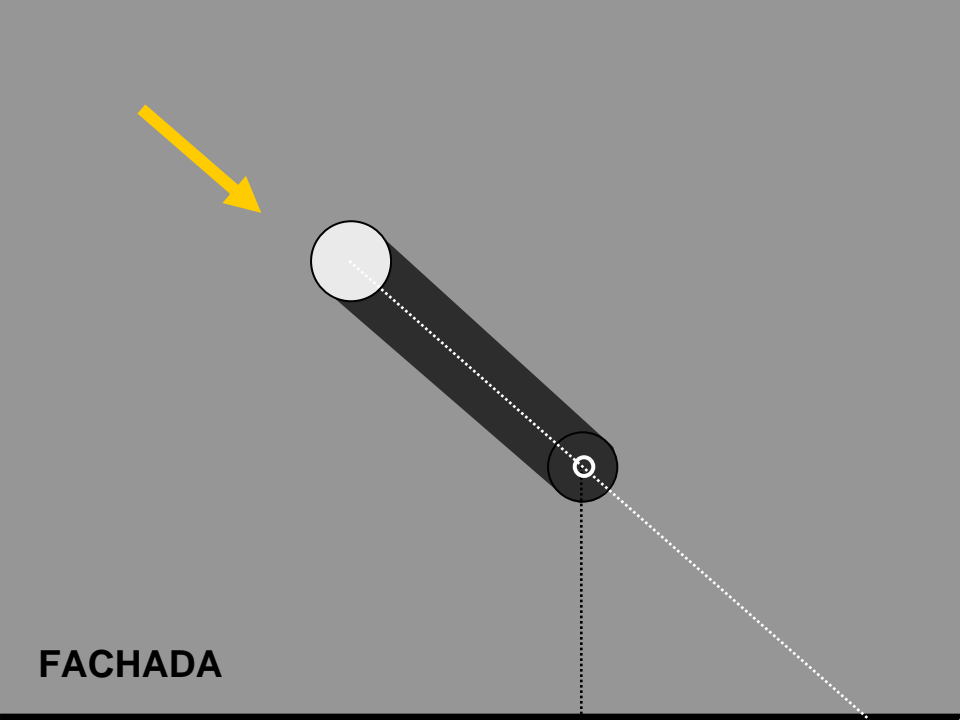

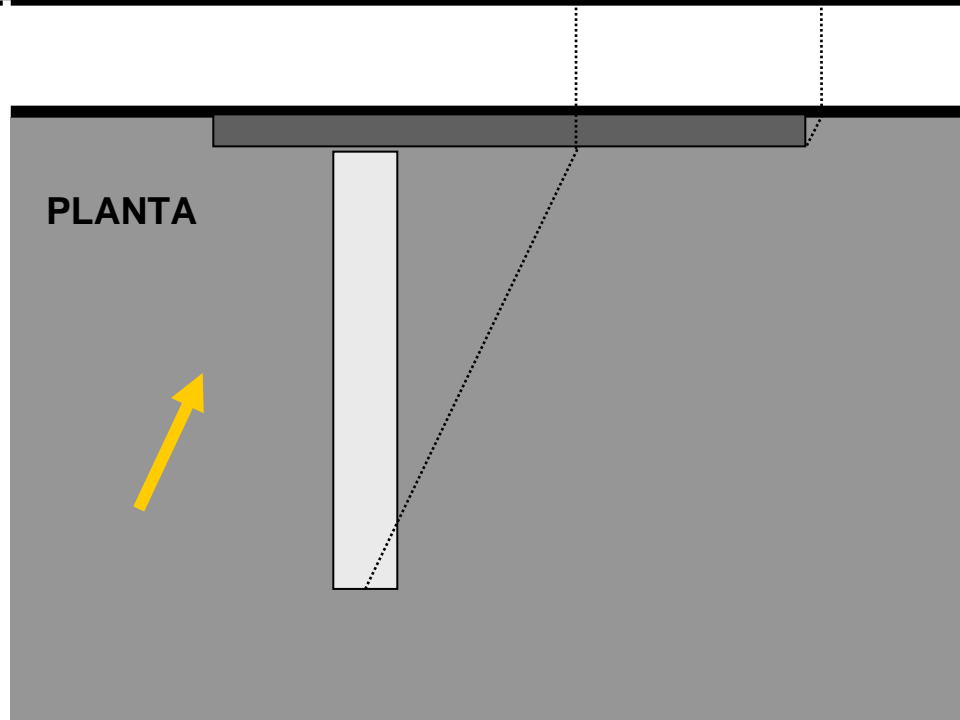
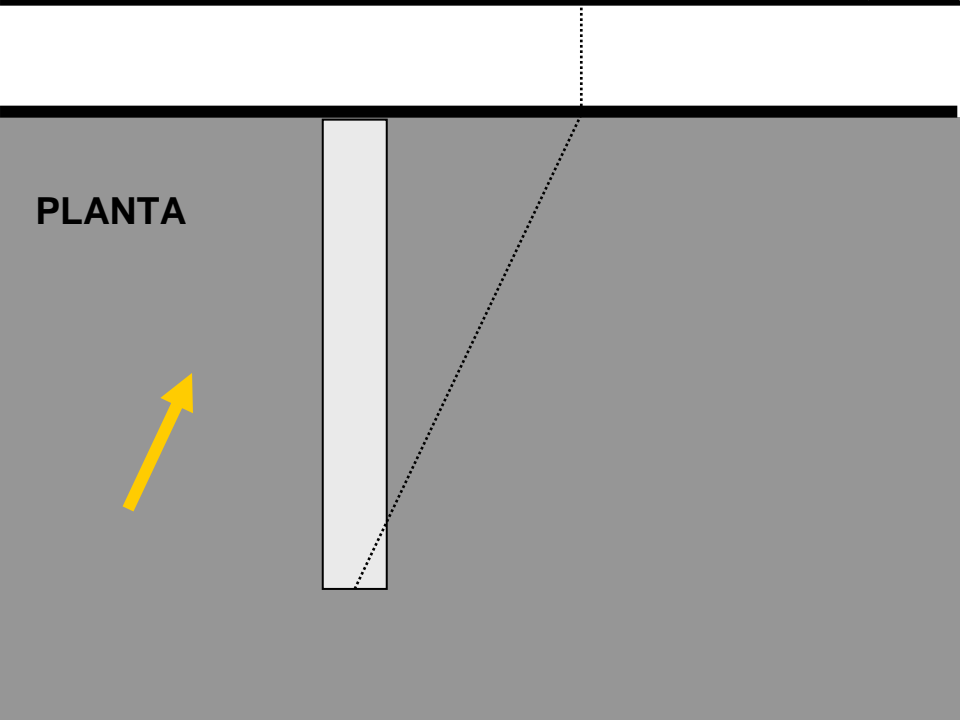
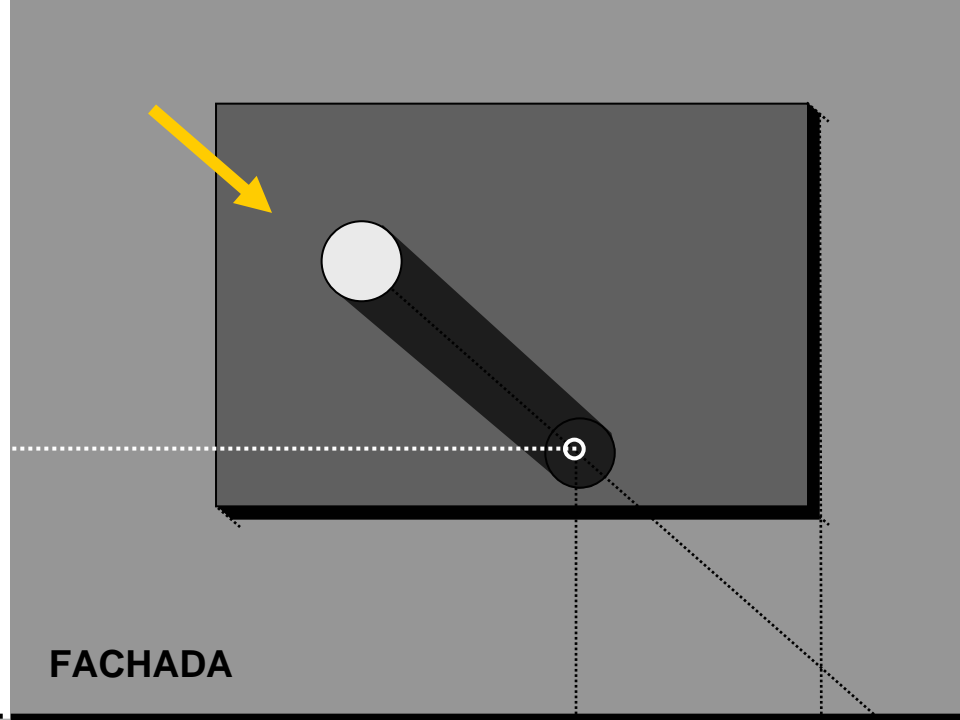
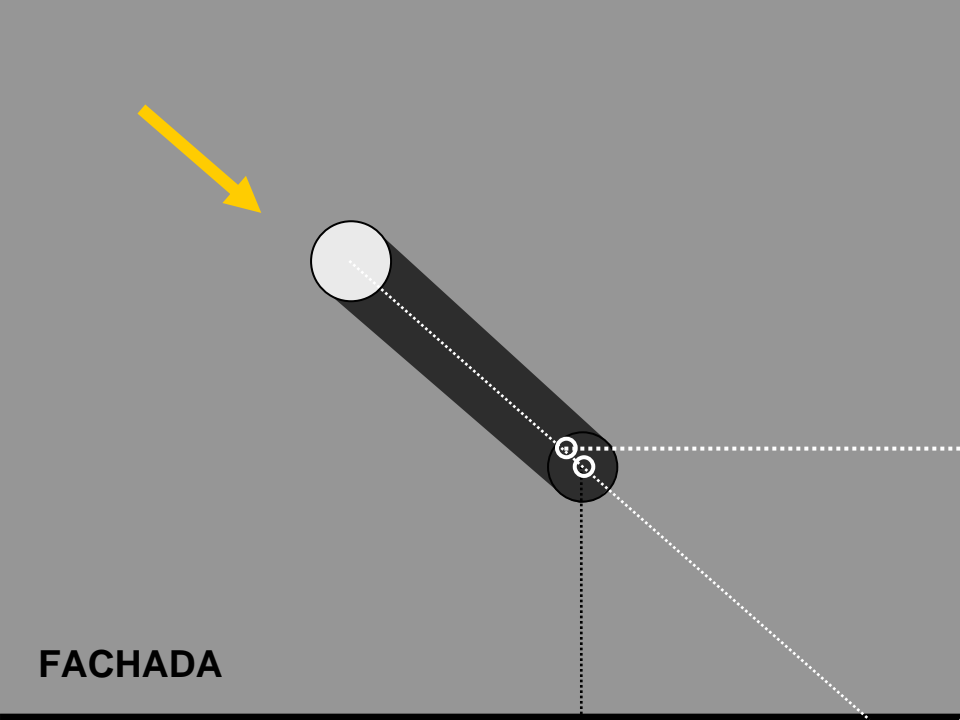

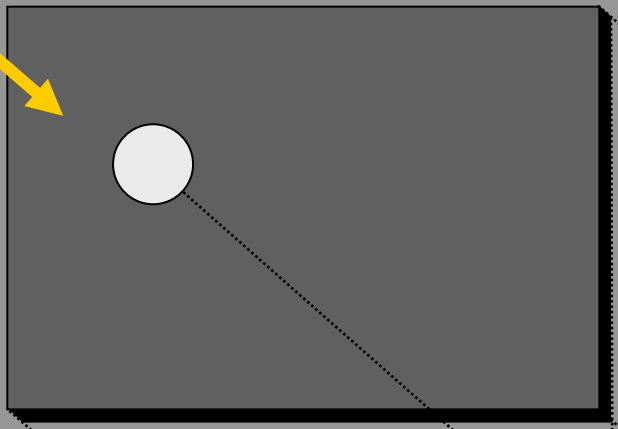

FACHADA

LT (PISO)



PLANTA

PARED

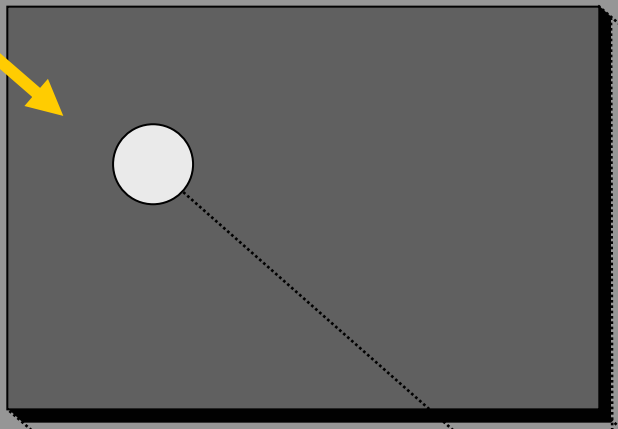

FACHADA

LT (PISO)

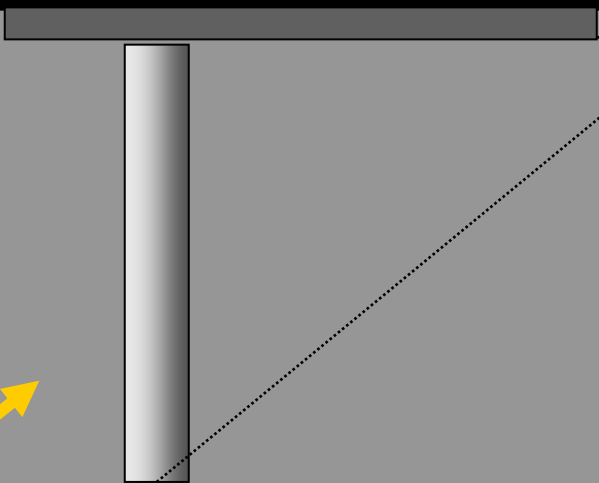

PLANTA

PARED

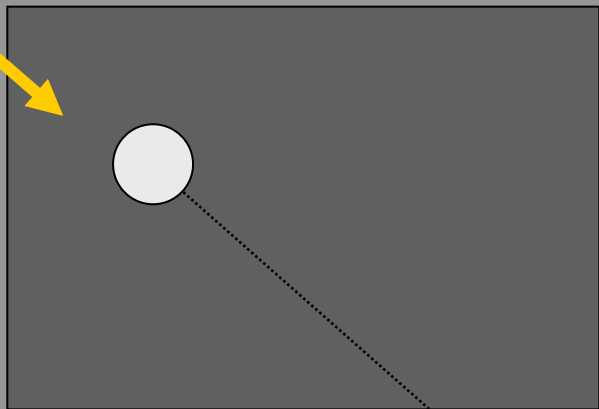

FACHADA

LT (PISO)

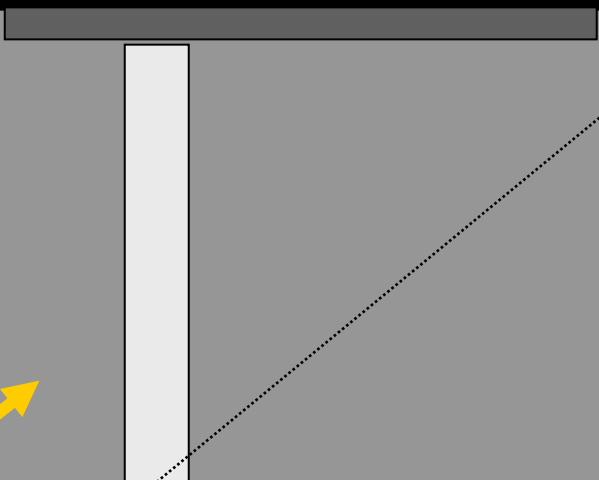

PLANTA

PARED

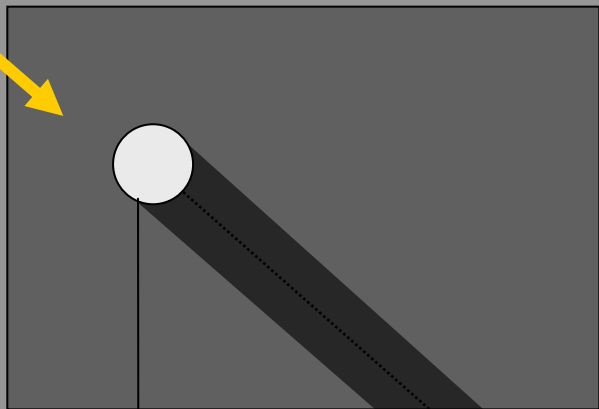

FACHADA

LT (PISO)



PLANTA

PARED



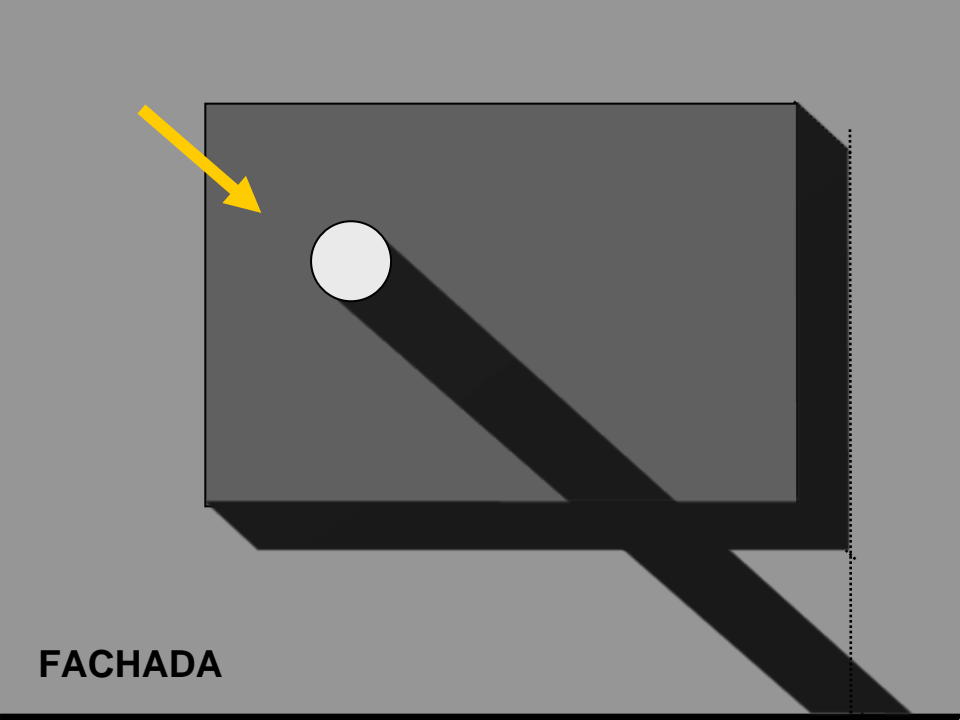

FACHADA



LT (PISO)

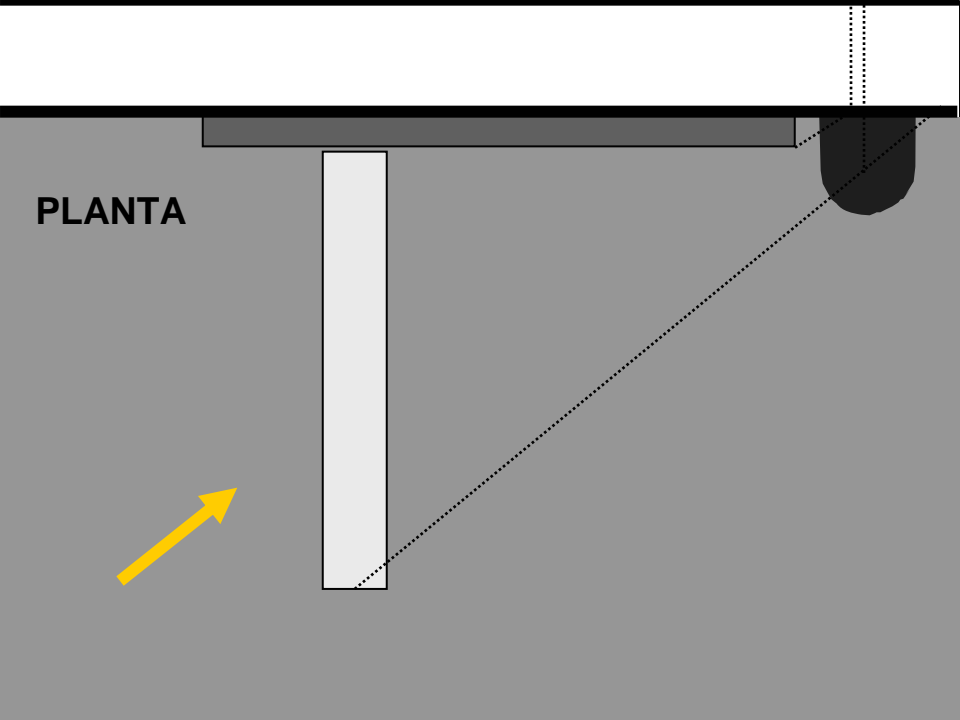

PLANTA

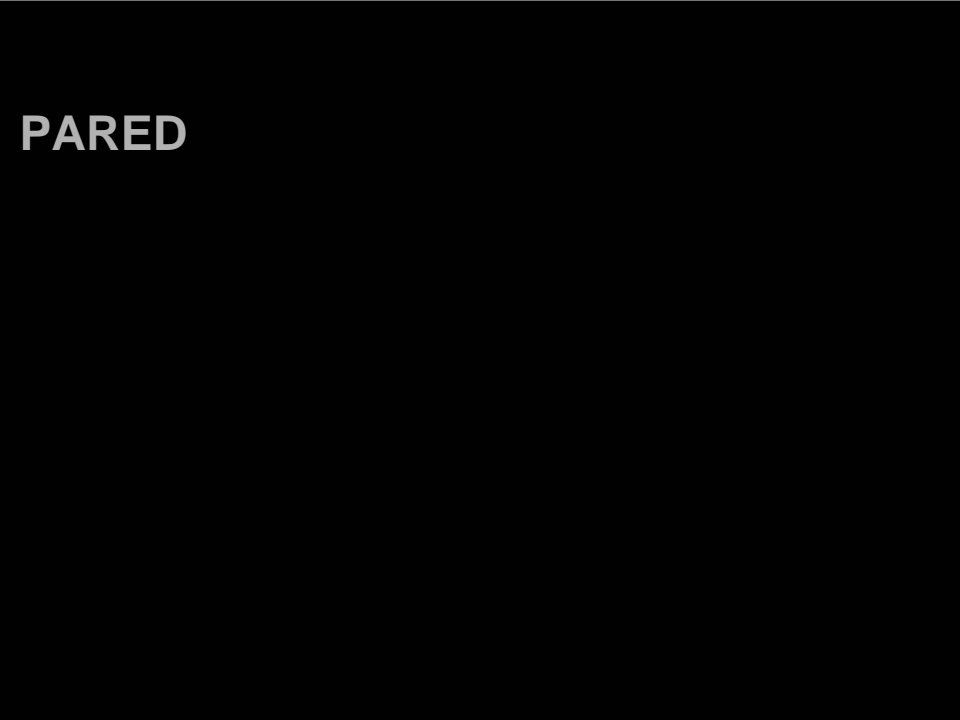

PARED



FACHADA

LT (PISO)



PLANTA

PARED

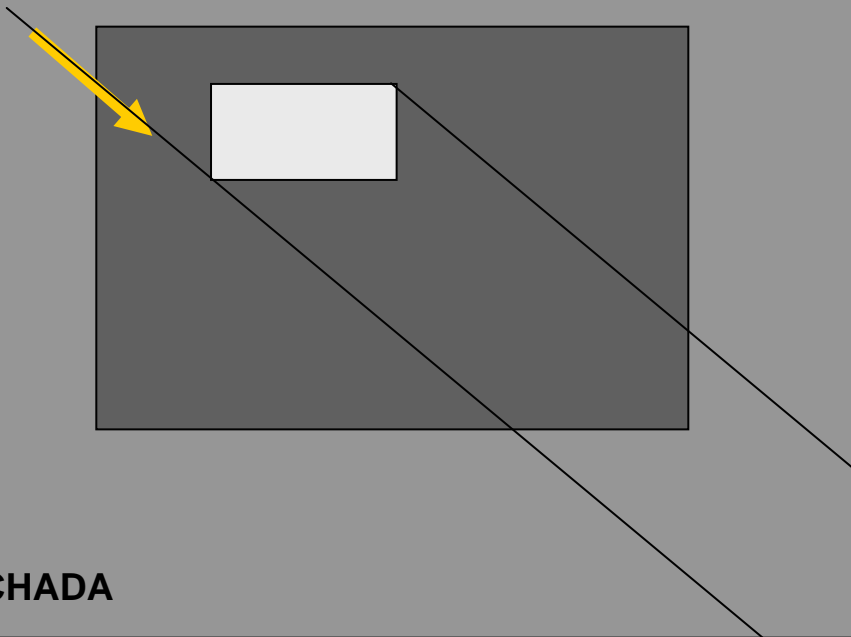

FACHADA

LT (PISO)

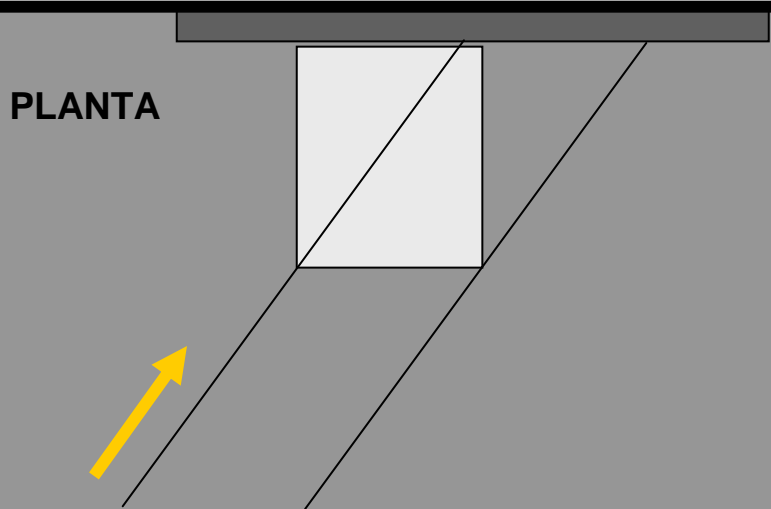

PLANTA

PARED

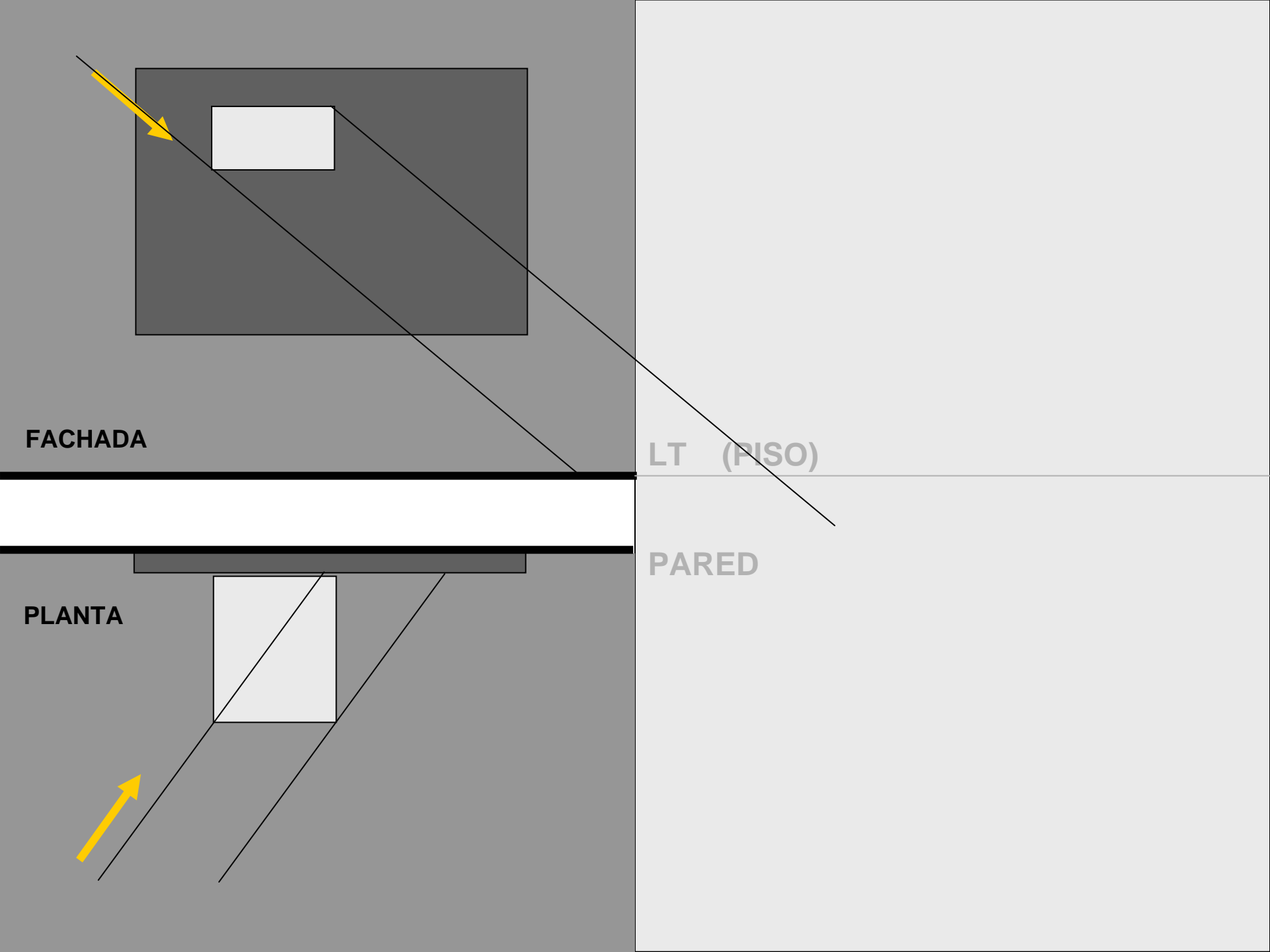

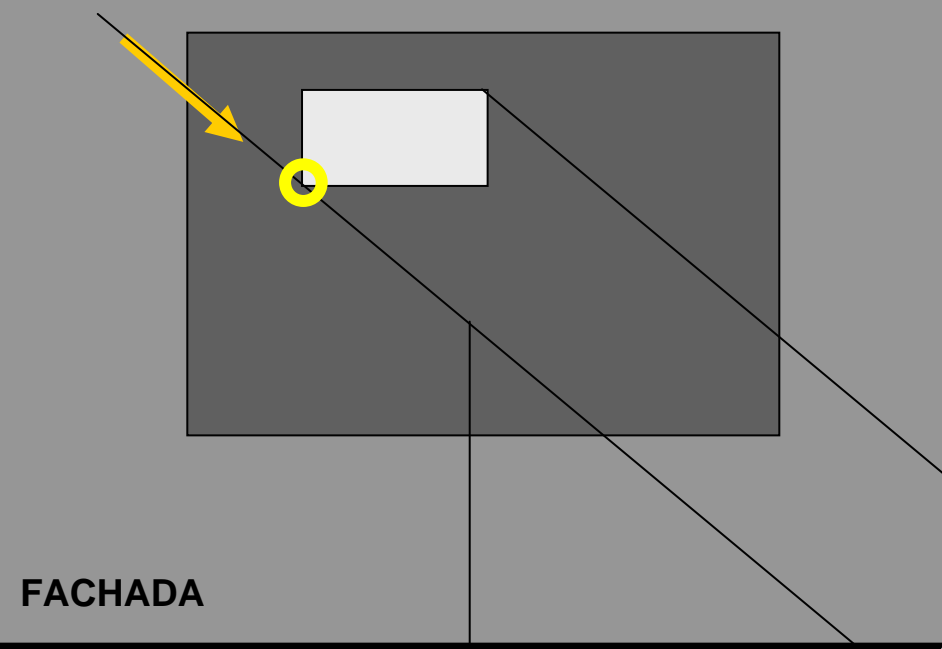

LT (PISO)

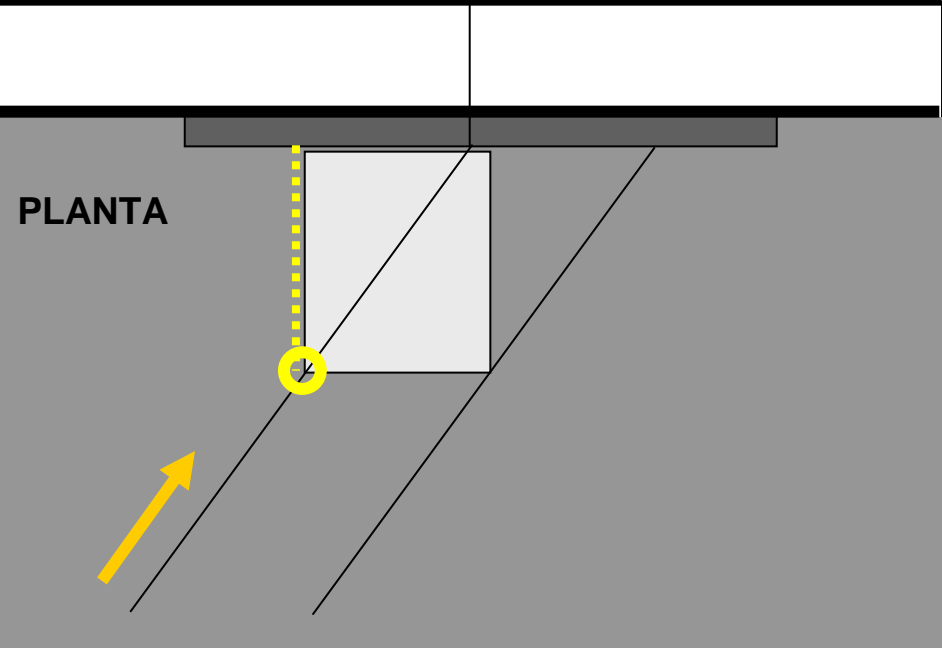

PARED

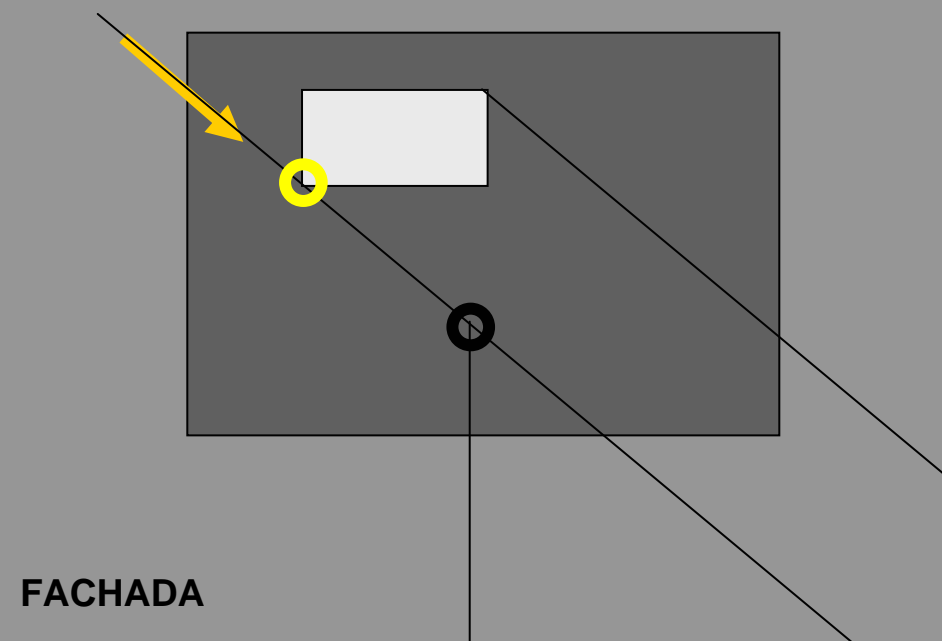

LT (PISO)

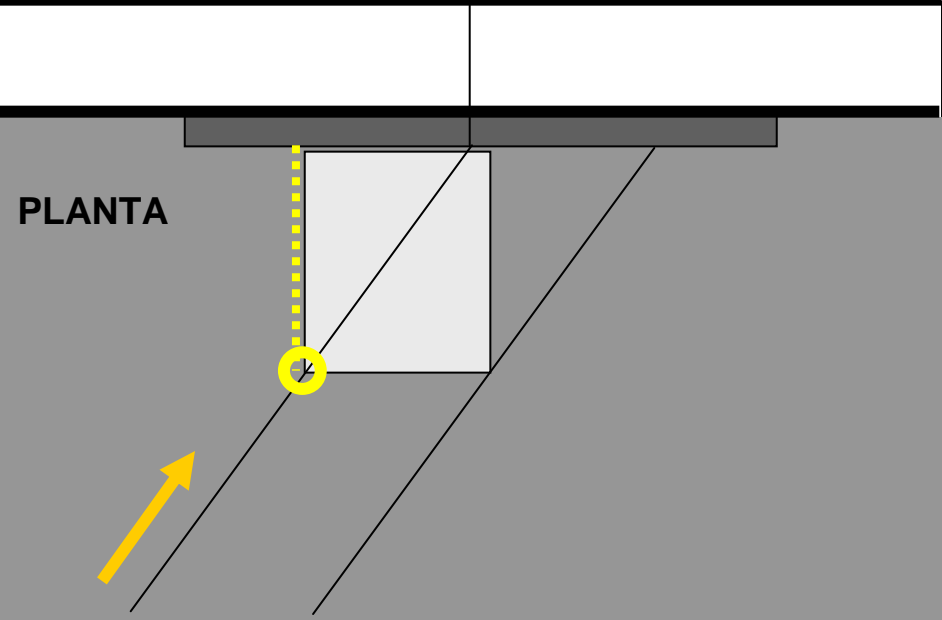

PARED

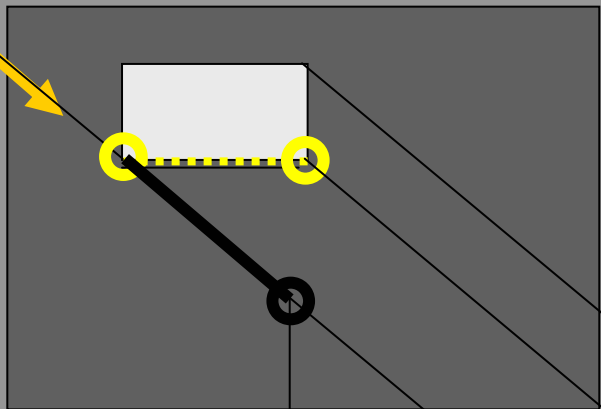

FACHADA

LT (PISO)

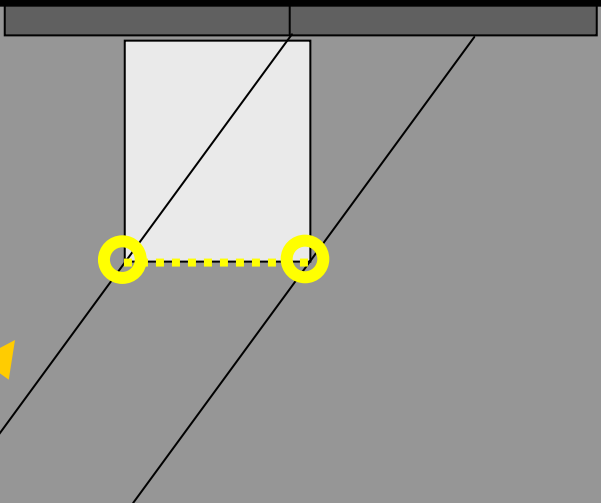

PLANTA

PARED

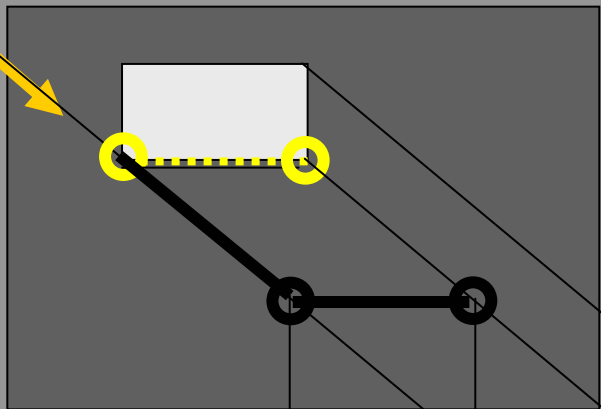

FACHADA

LT (PISO)



PLANTA

PARED

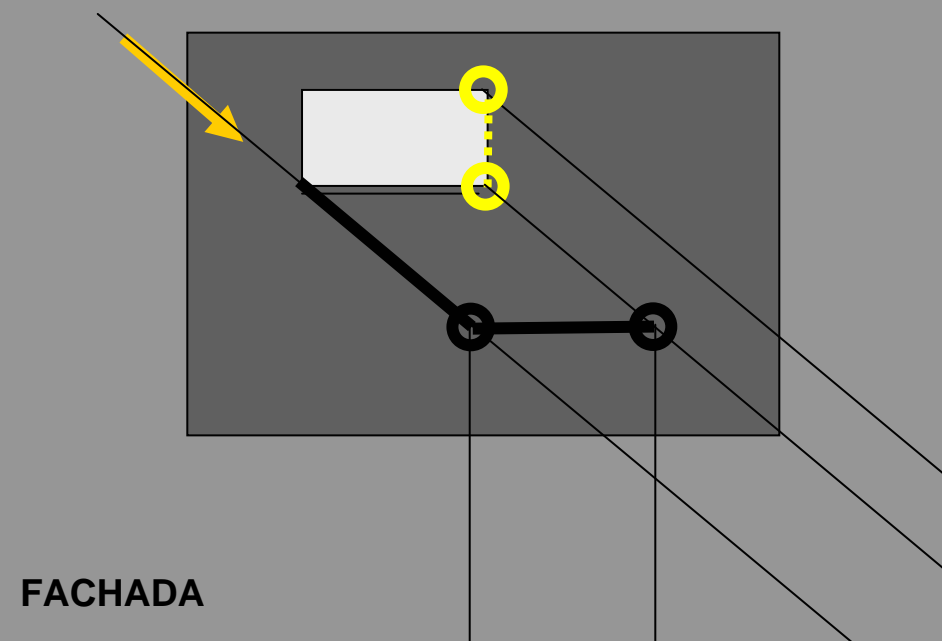

LT (PISO)

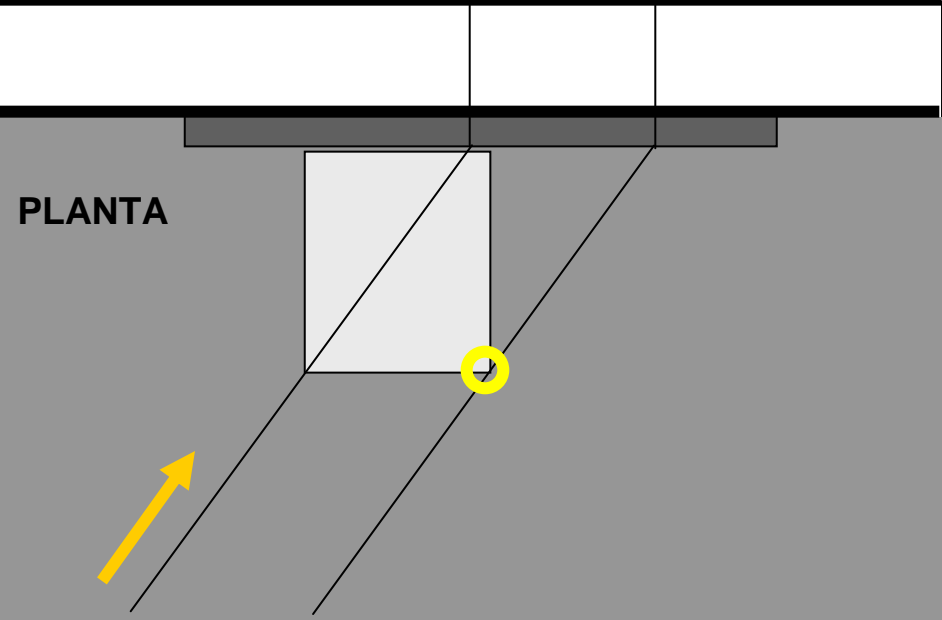

PARED

FACHADA

LT (PISO)

PLANTA

PARED

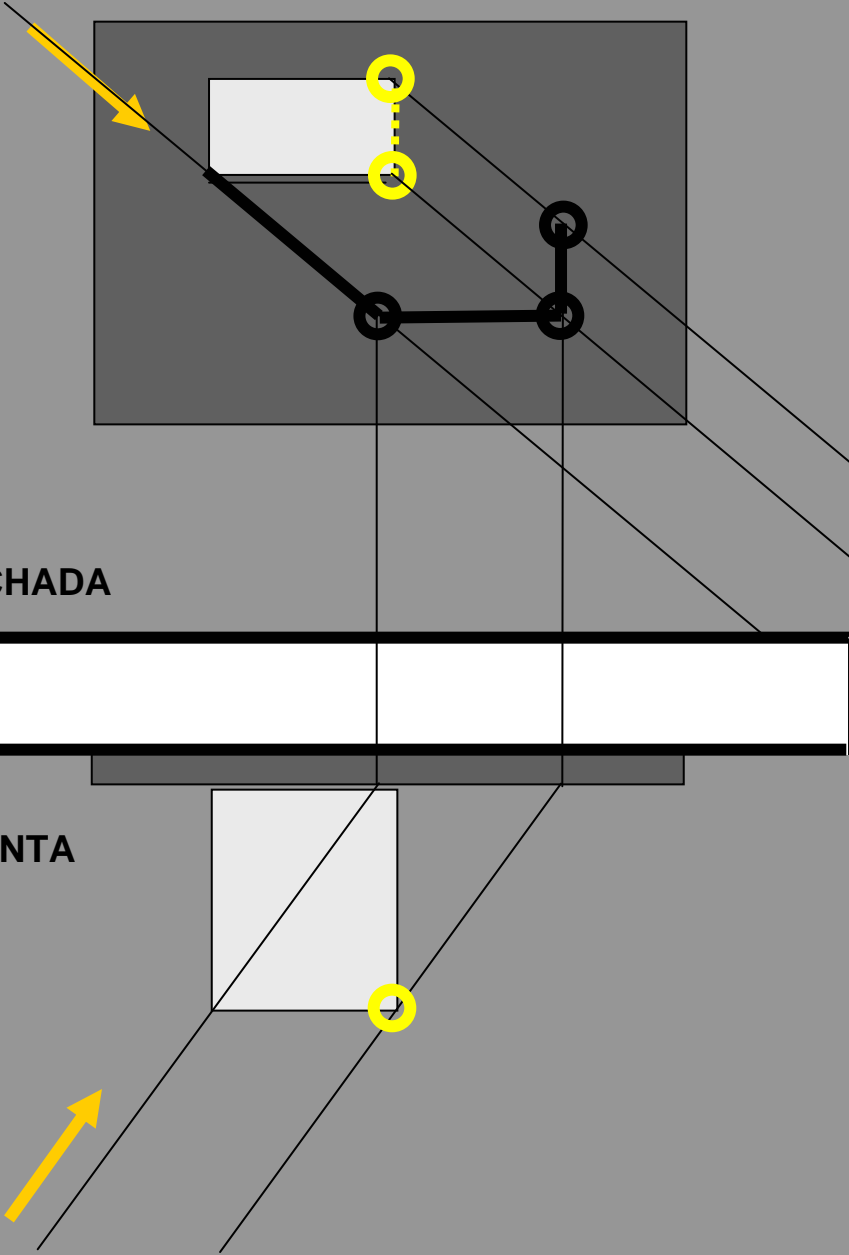

FACHADA

LT (PISO)

PLANTA

PARED

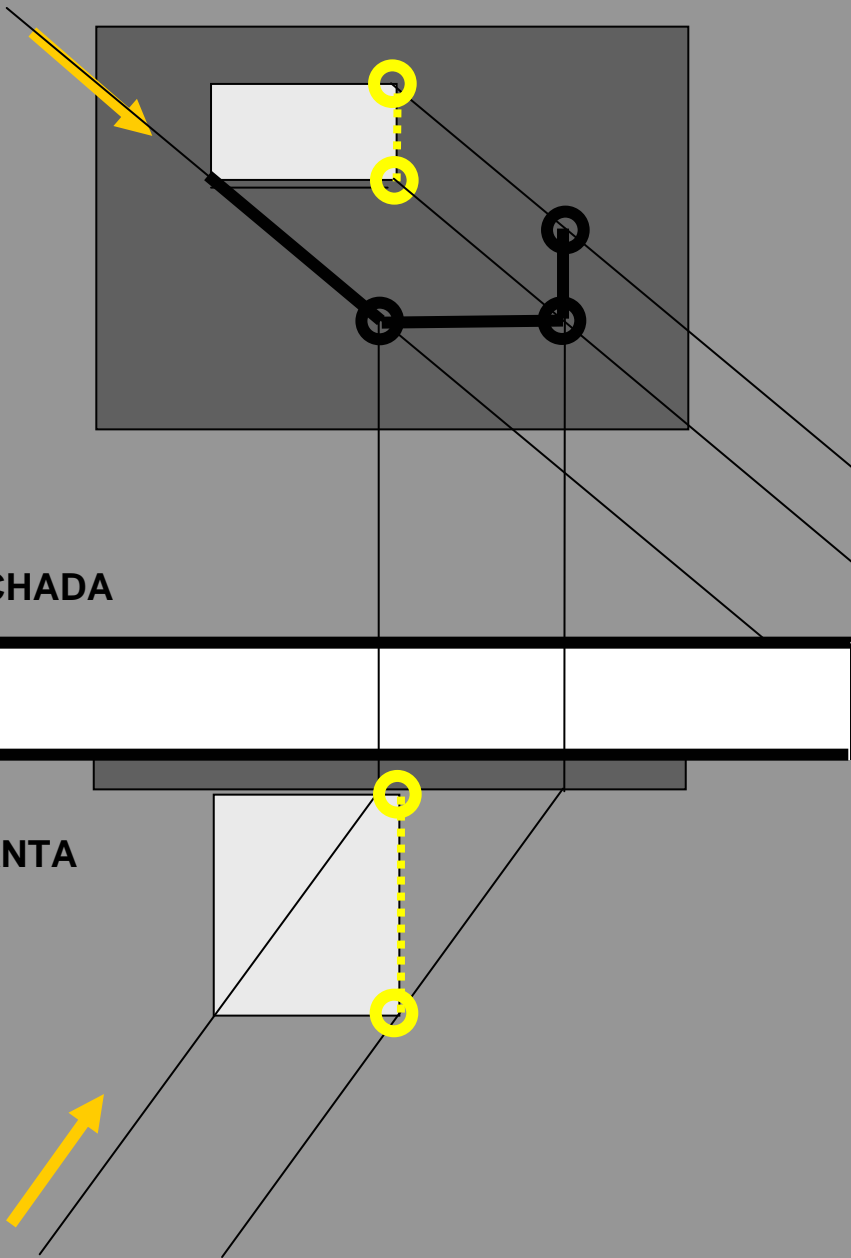

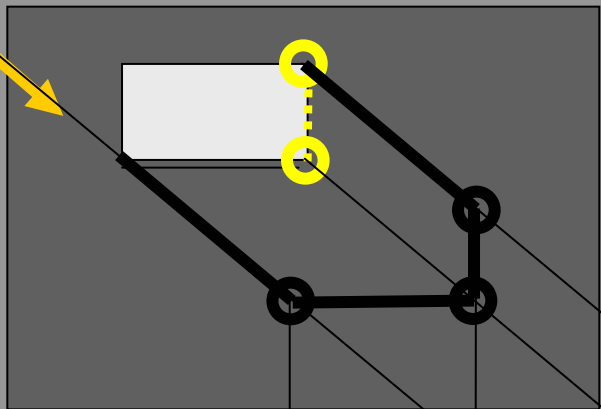

FACHADA

LT (PISO)

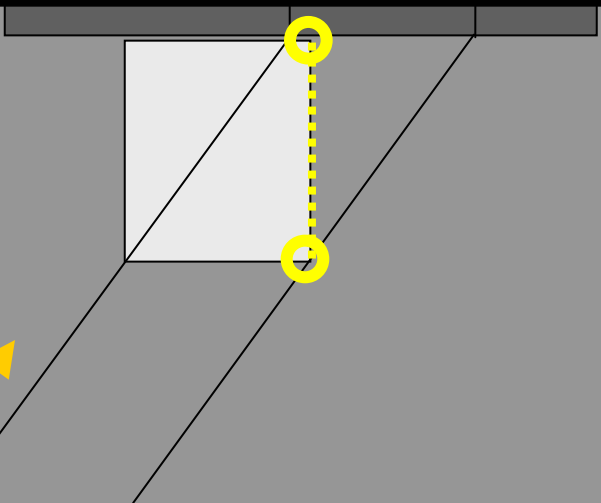

PLANTA

PARED

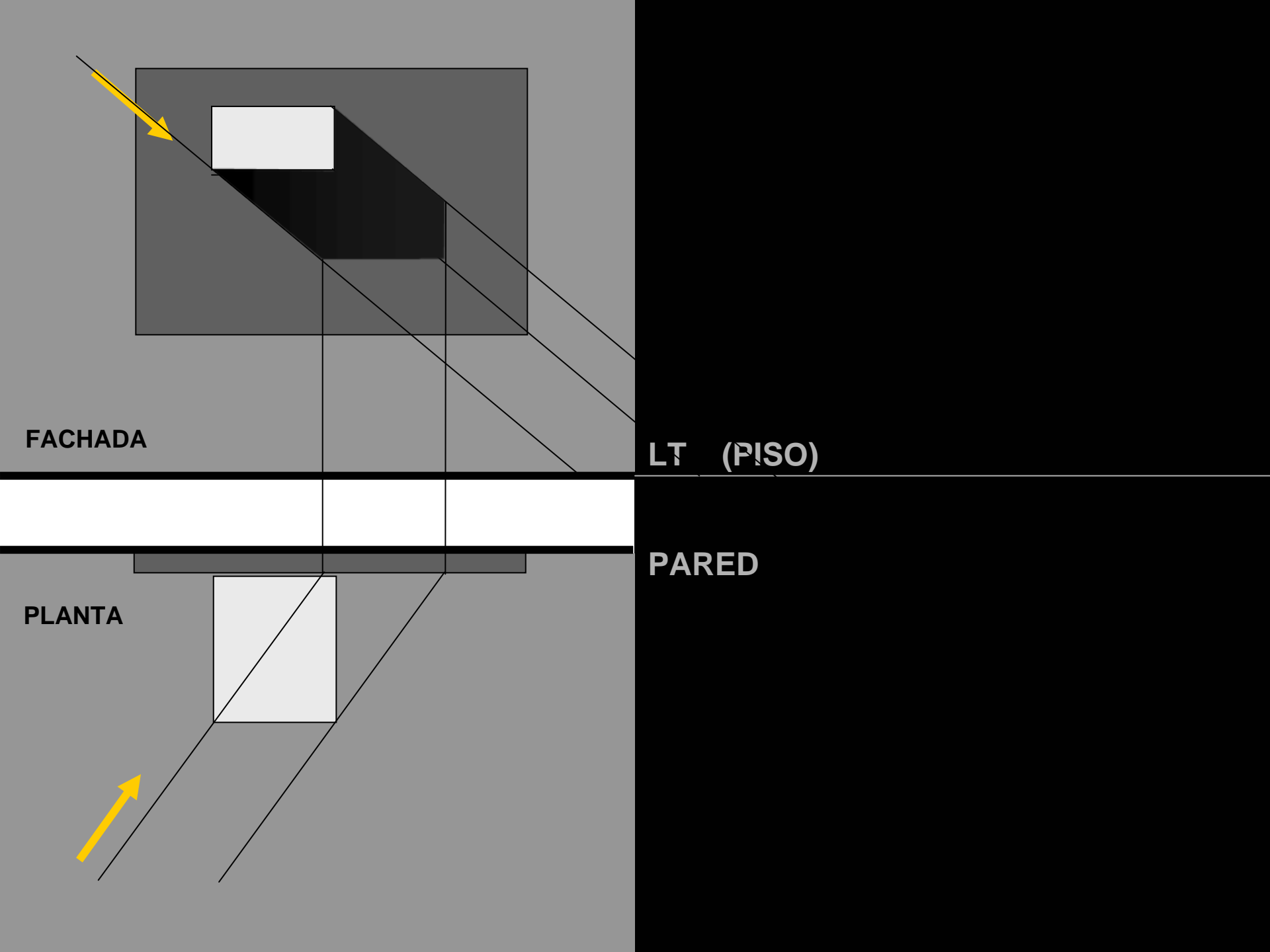

FACHADA

LT (PISO)

PLANTA

PARED

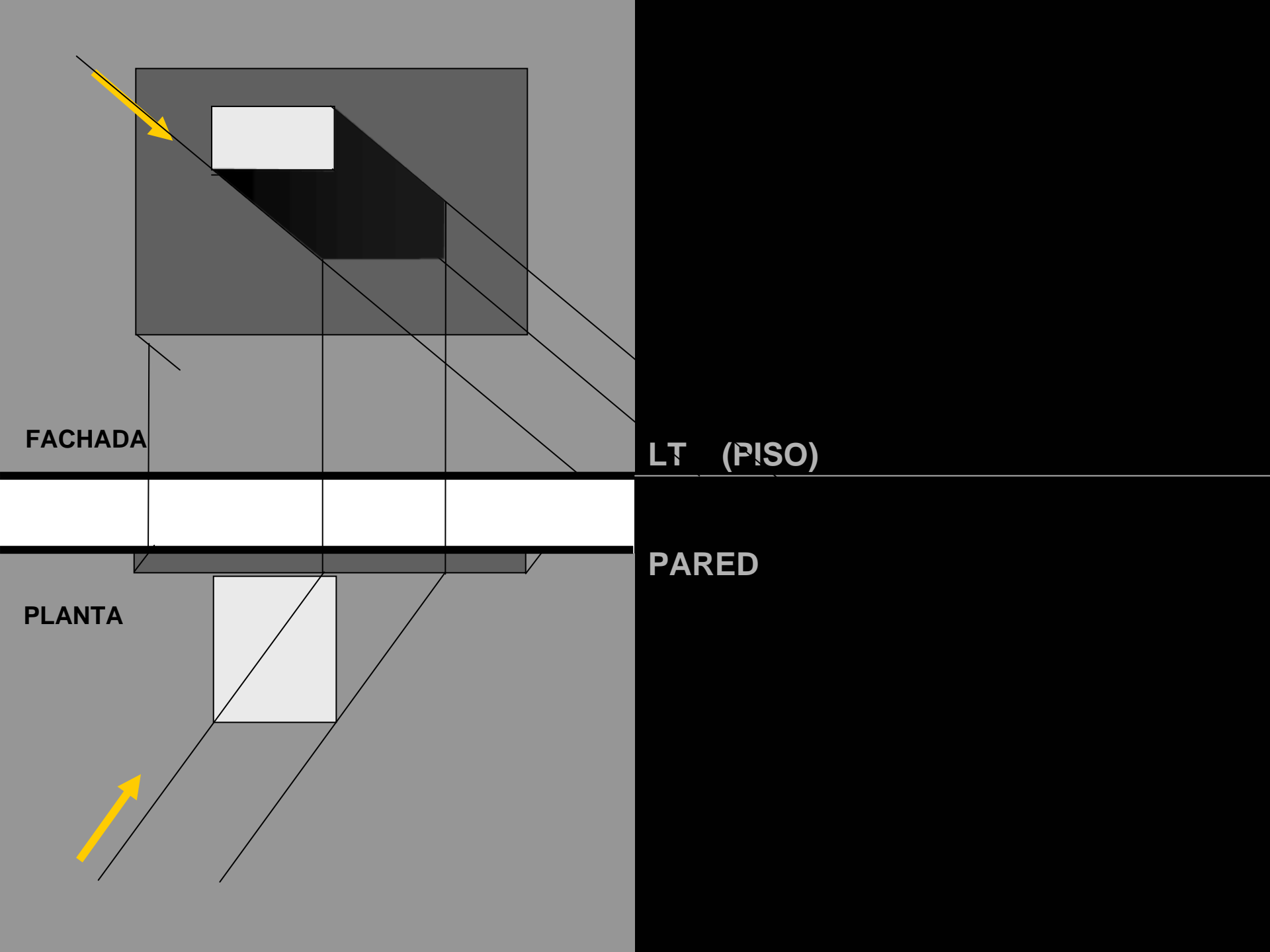

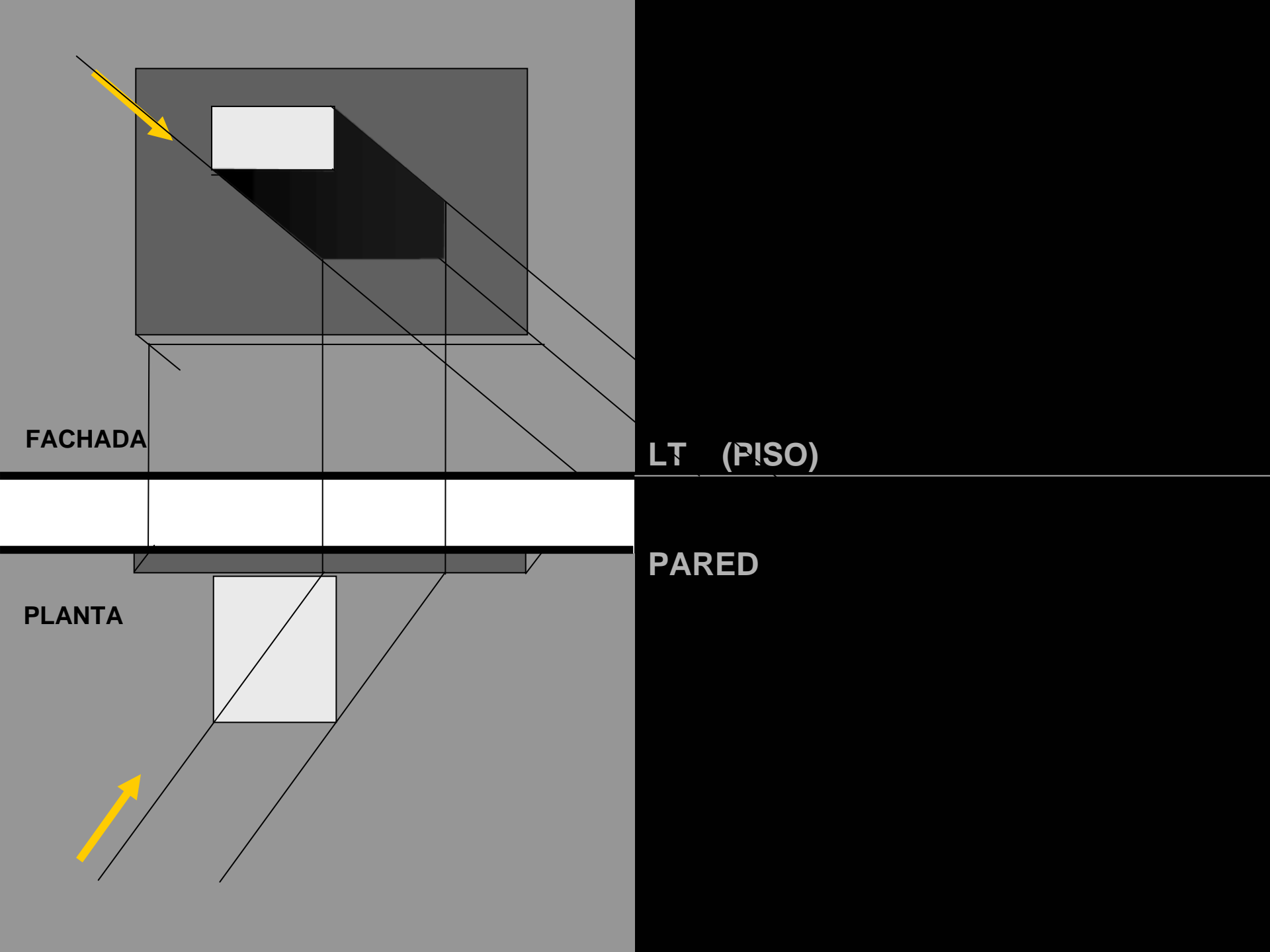

FACHADA

LT (PISO)

PLANTA

PARED

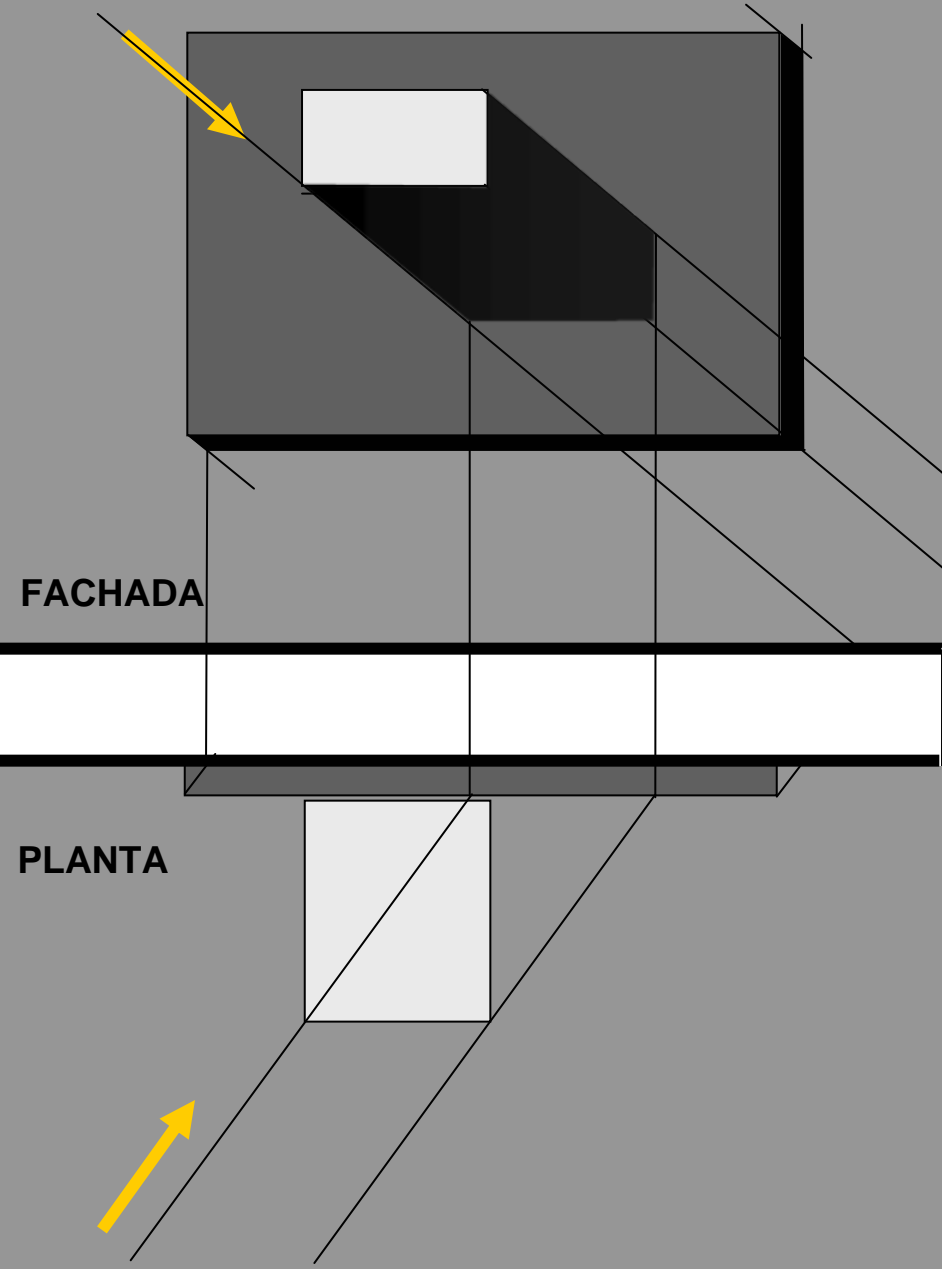

FACHADA

LT (PISO)

PLANTA

PARED

FACHADA

LT (PISO)

FACHADA LATERAL

PLANTA

PARED

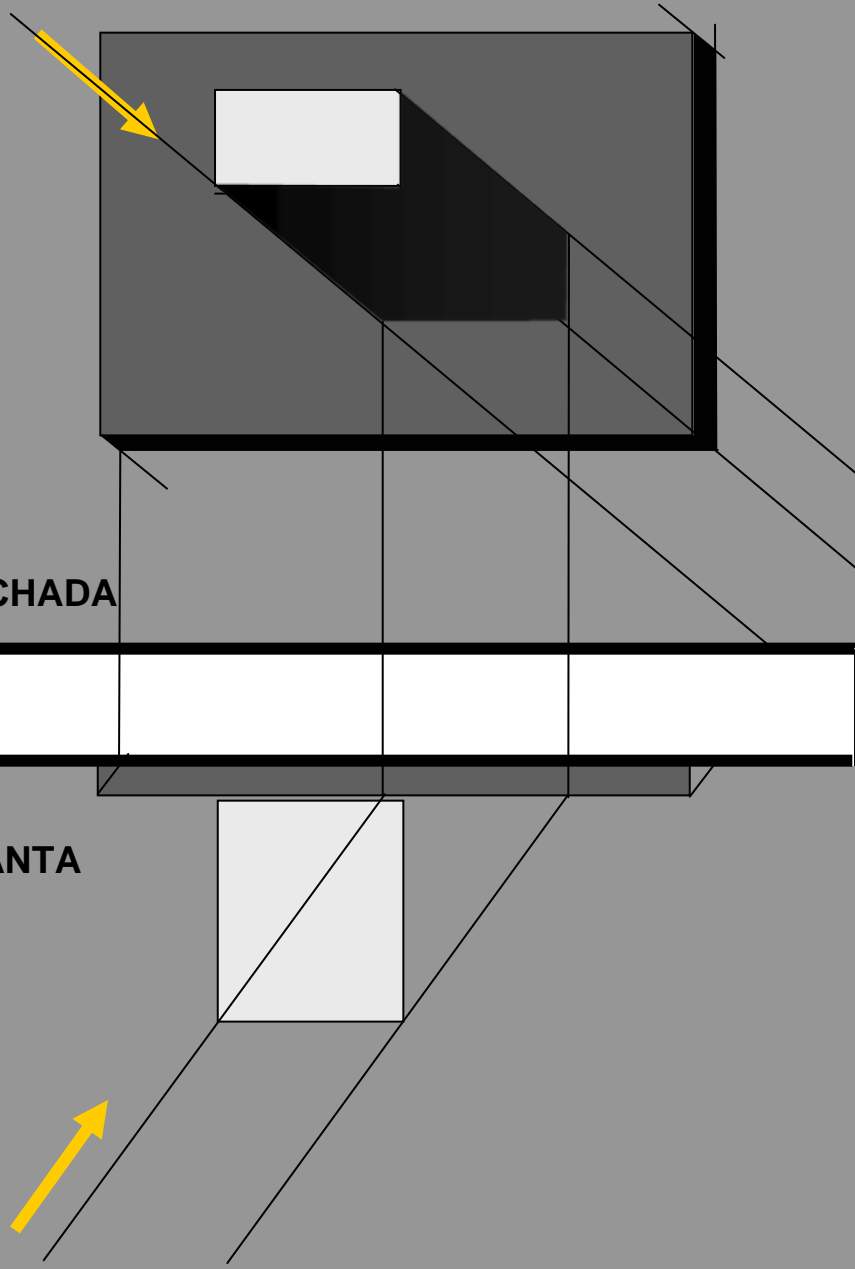

FACHADA

LT (PISO)

PLANTA

PARED

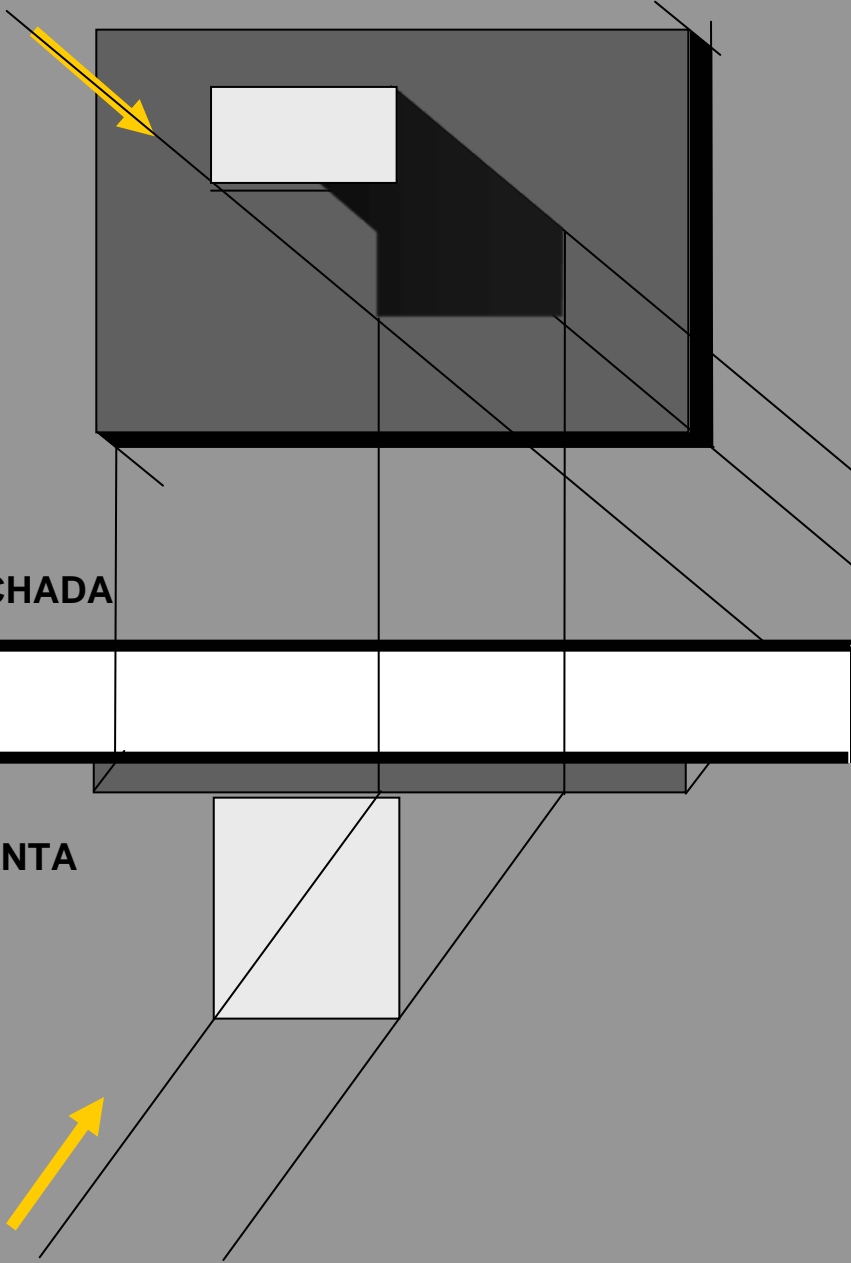

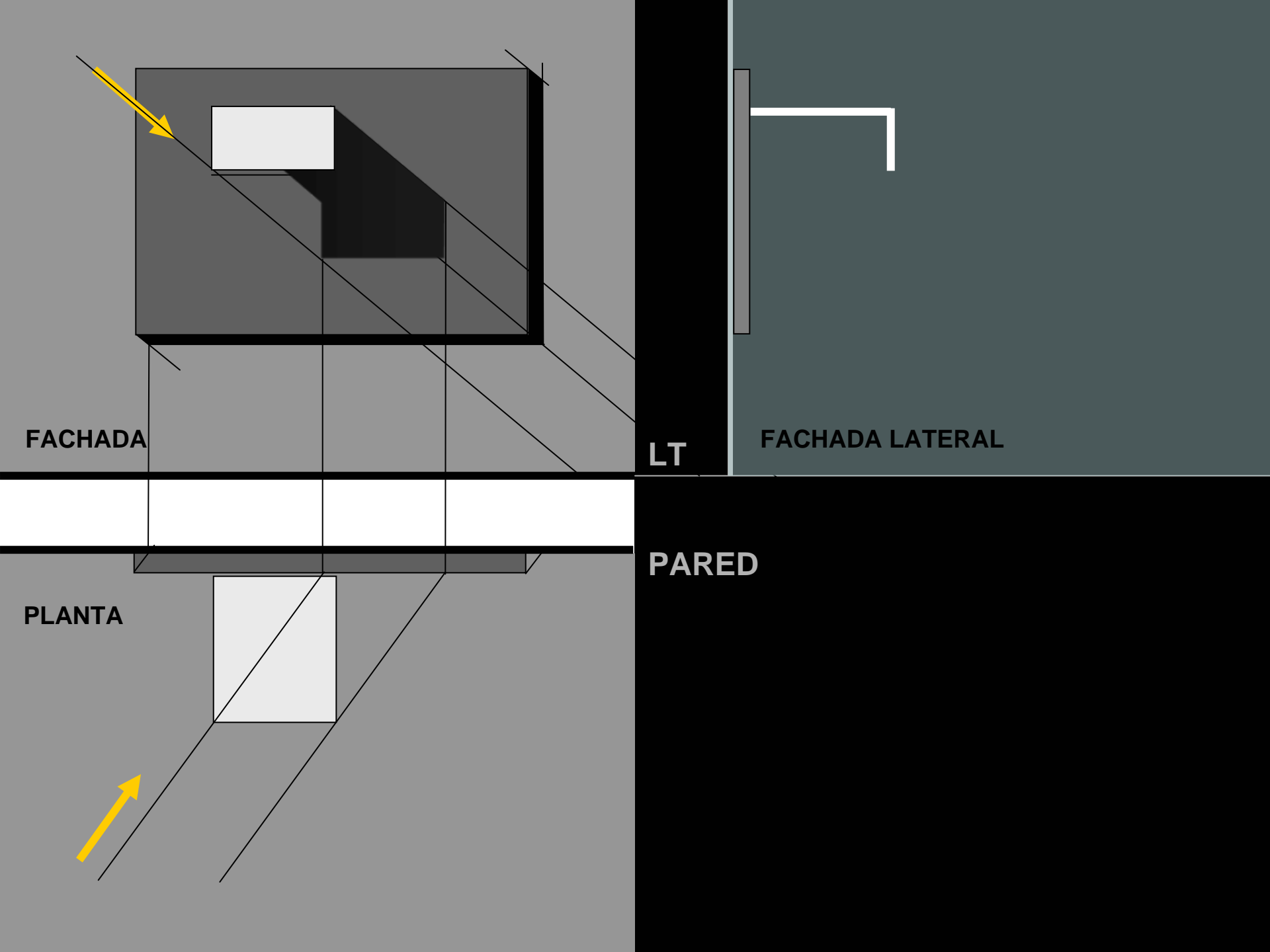

FACHADA

PLANTA

LT

FACHADA LATERAL

PARED

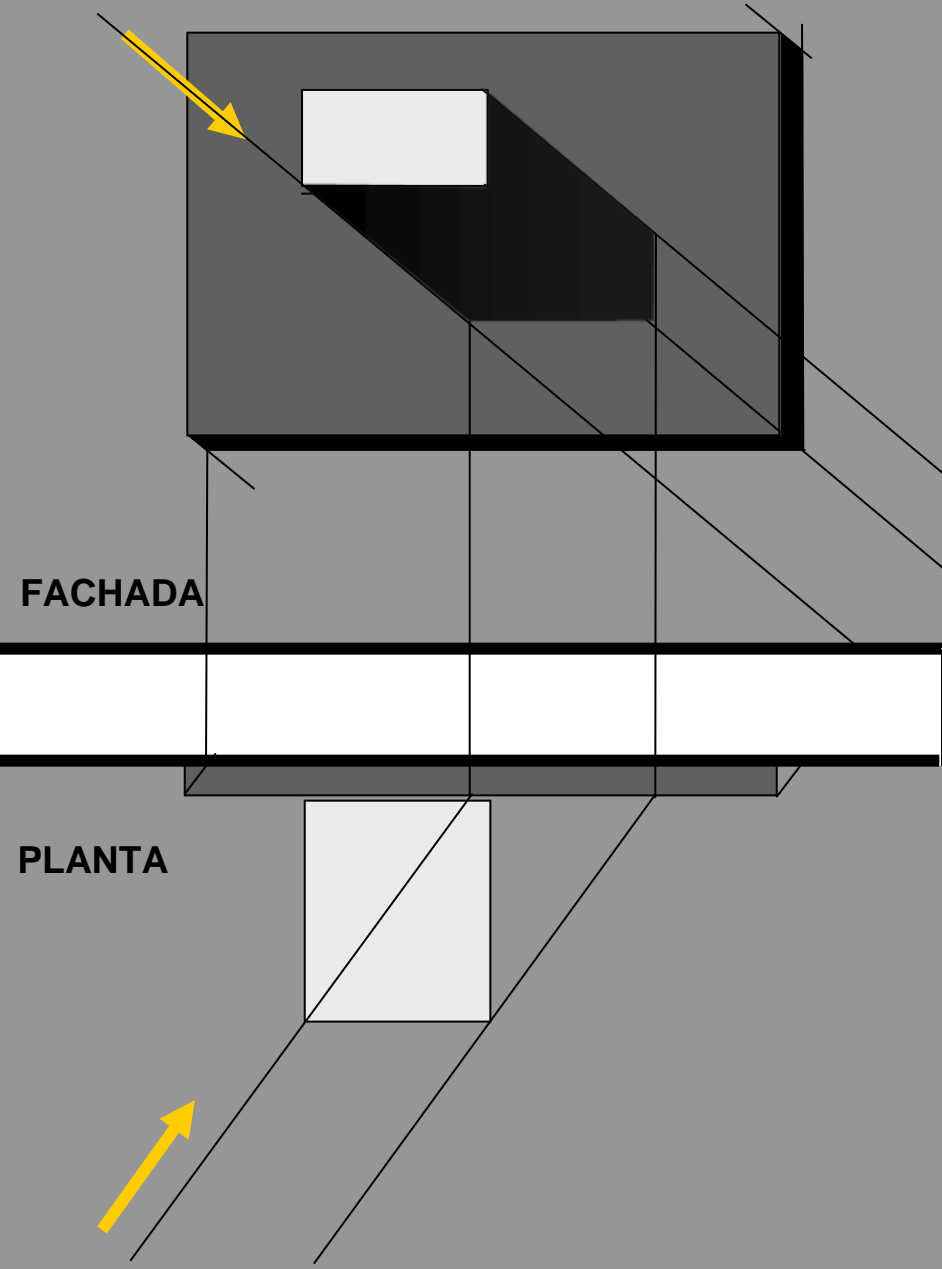

FACHADA

LT (PISO)

PLANTA

PARED

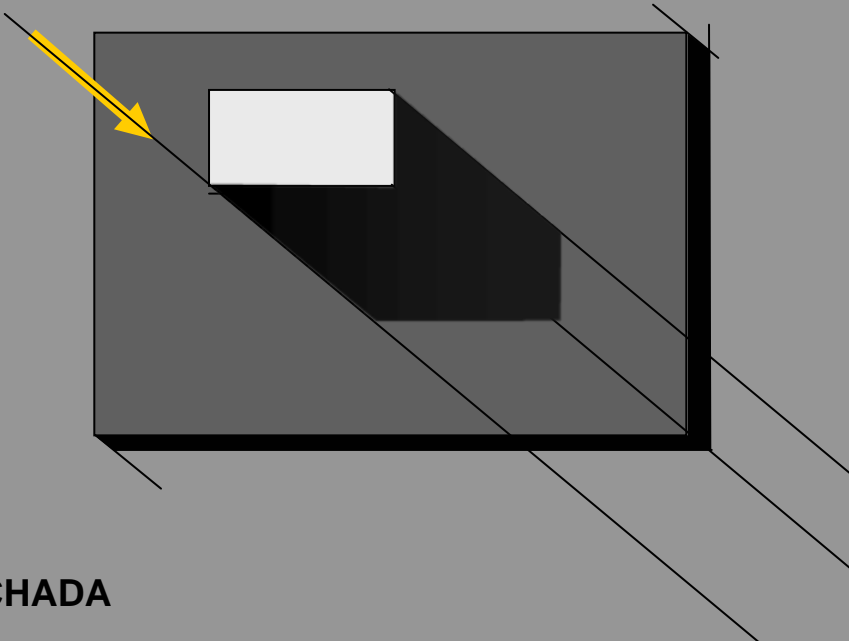

FACHADA

LT (PISO)



PLANTA

PARED

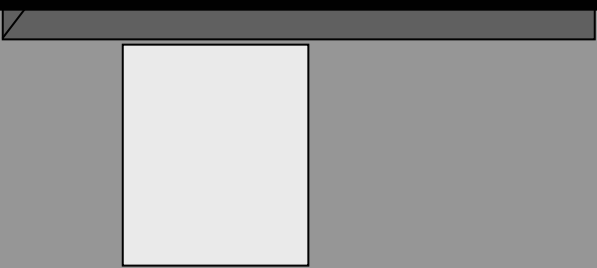

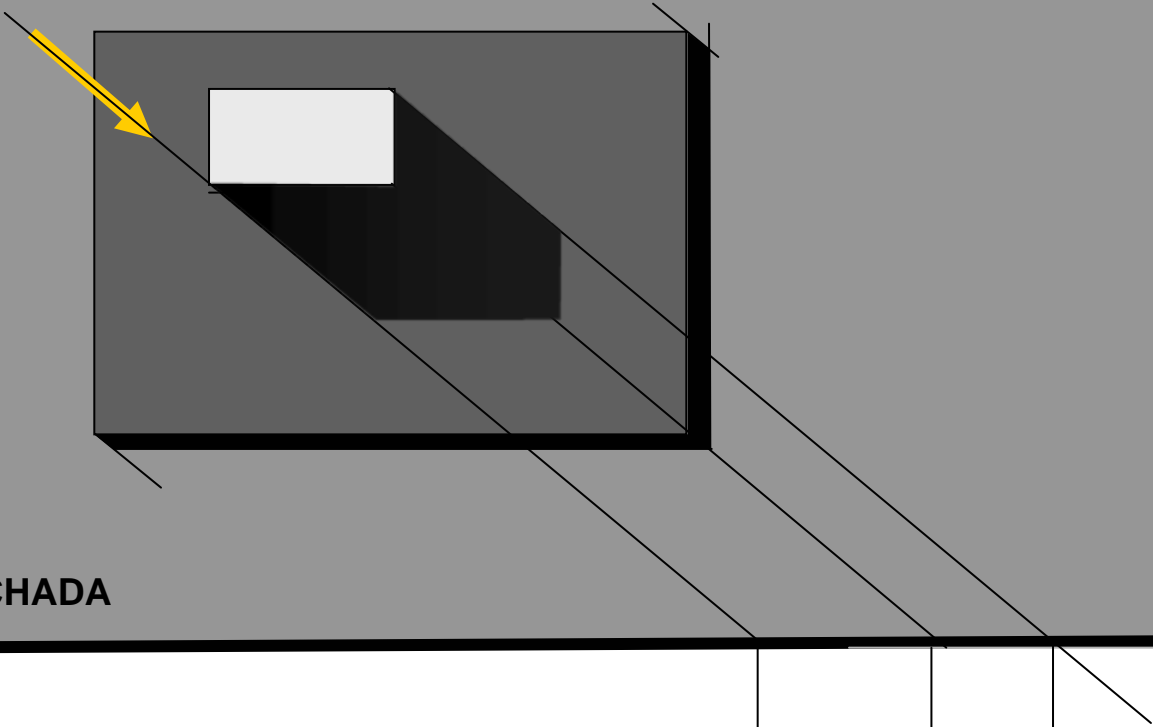

FACHADA

LT (PISO)

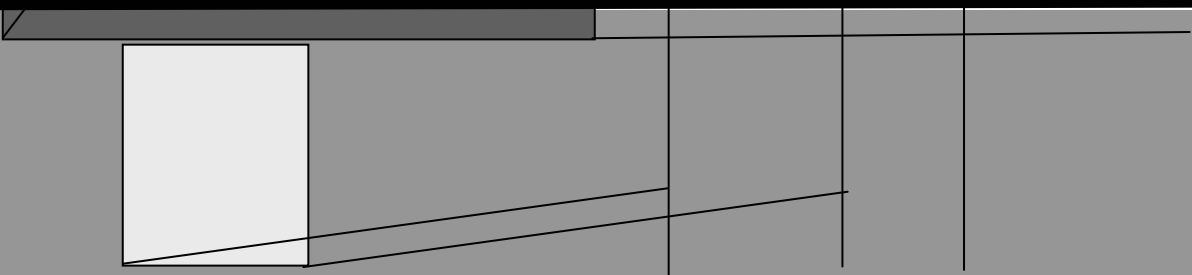

PLANTA

PARED

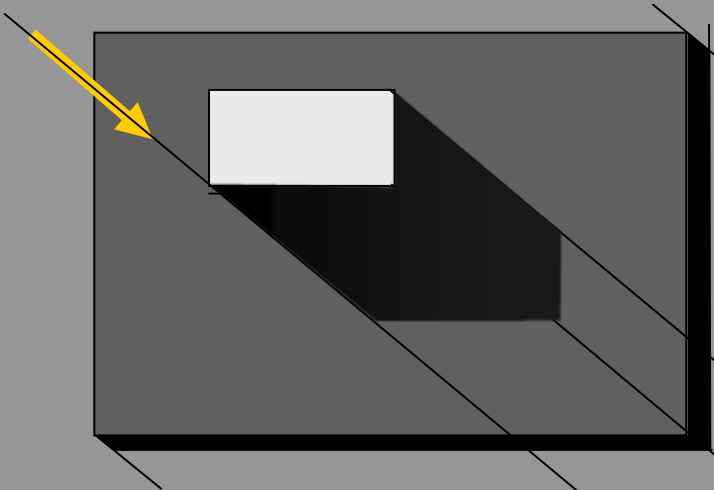

FACHADA

LT (PISO)

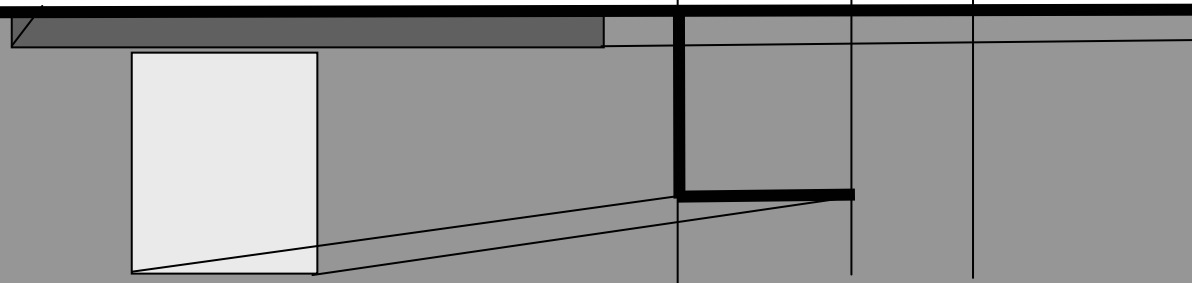

PLANTA

PARED

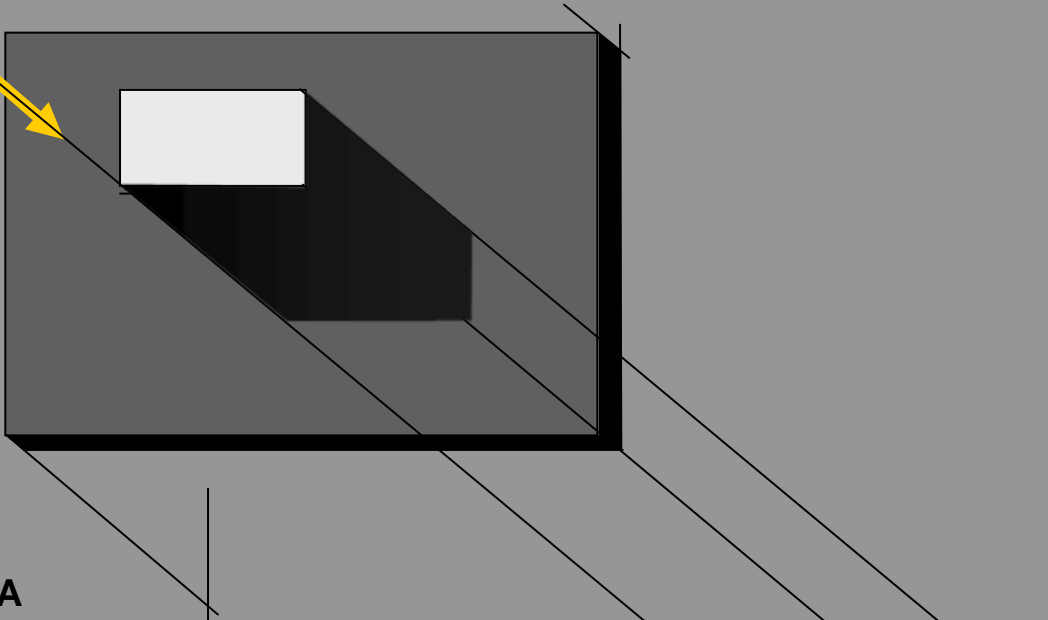

FACHADA

LT (PISO)

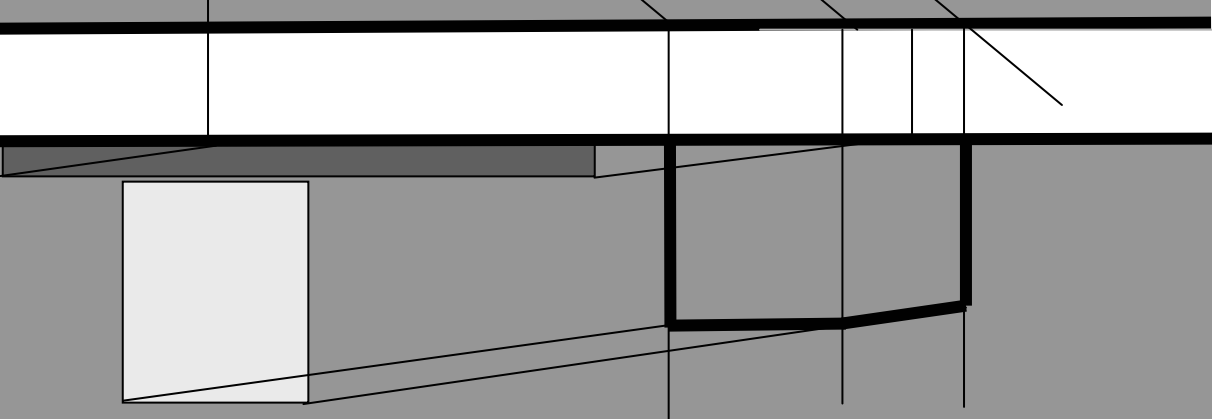

PLANTA

PARED



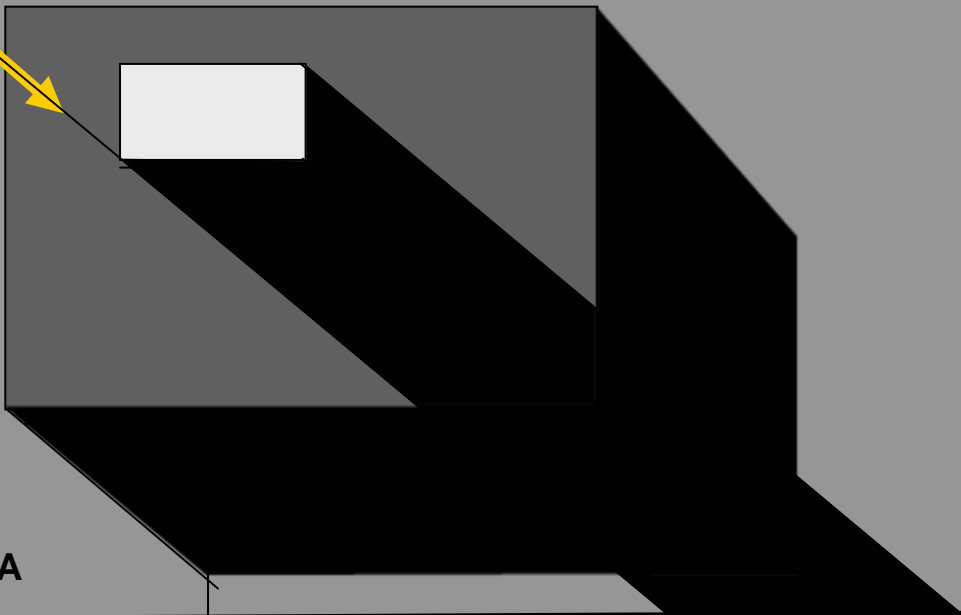

FACHADA

LT (PISO)



PLANTA

PARED

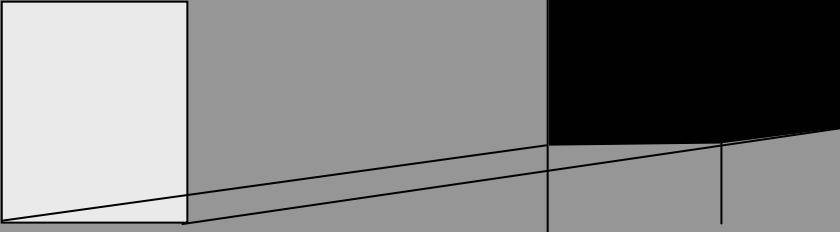

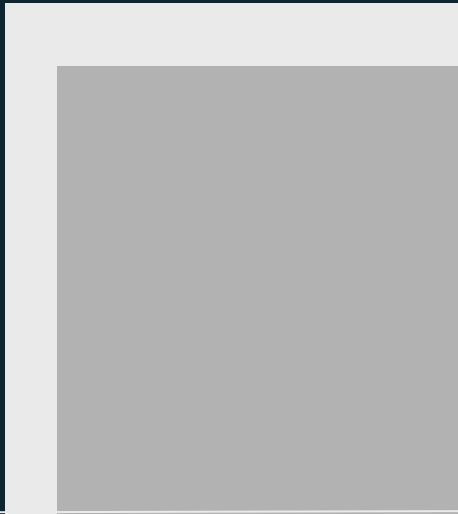

FACHADA

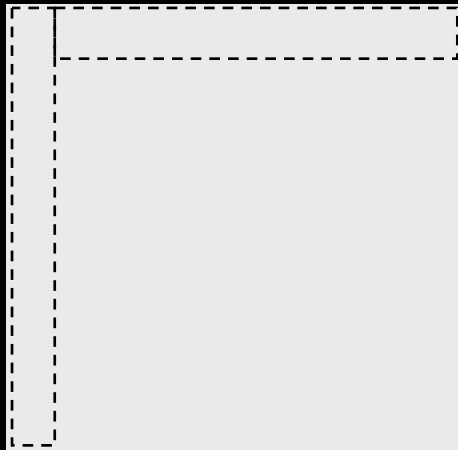

PLANTA

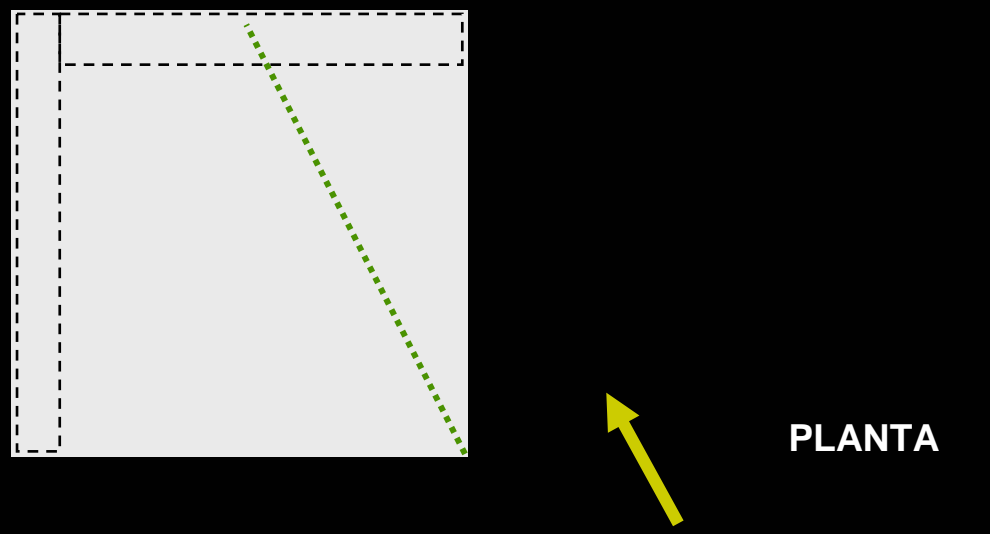
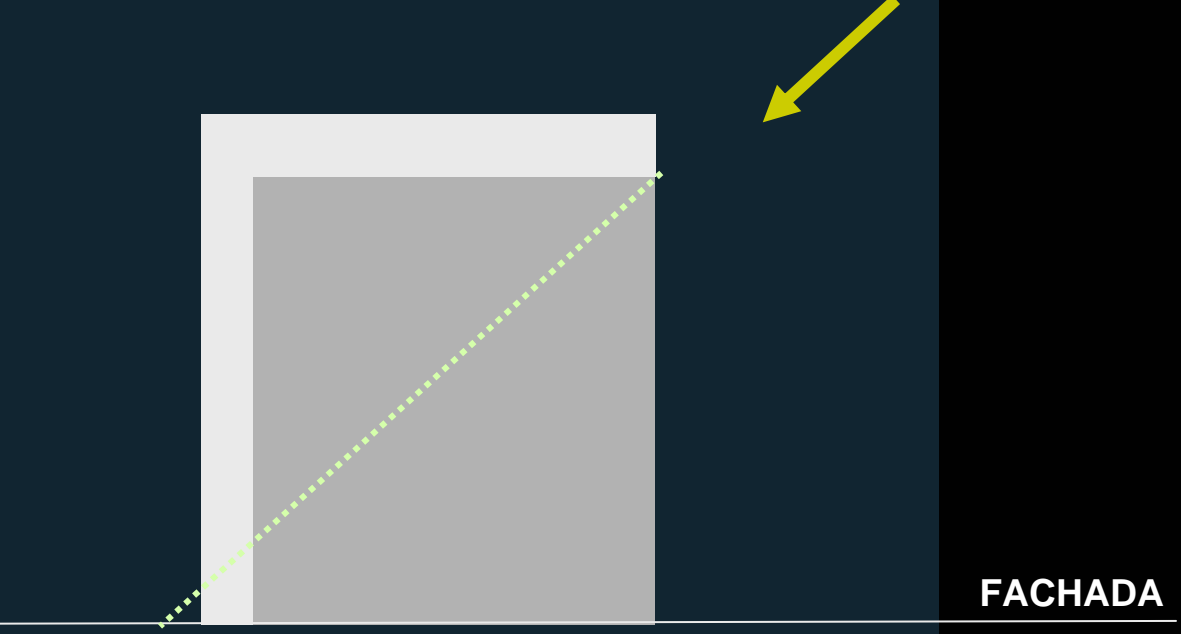

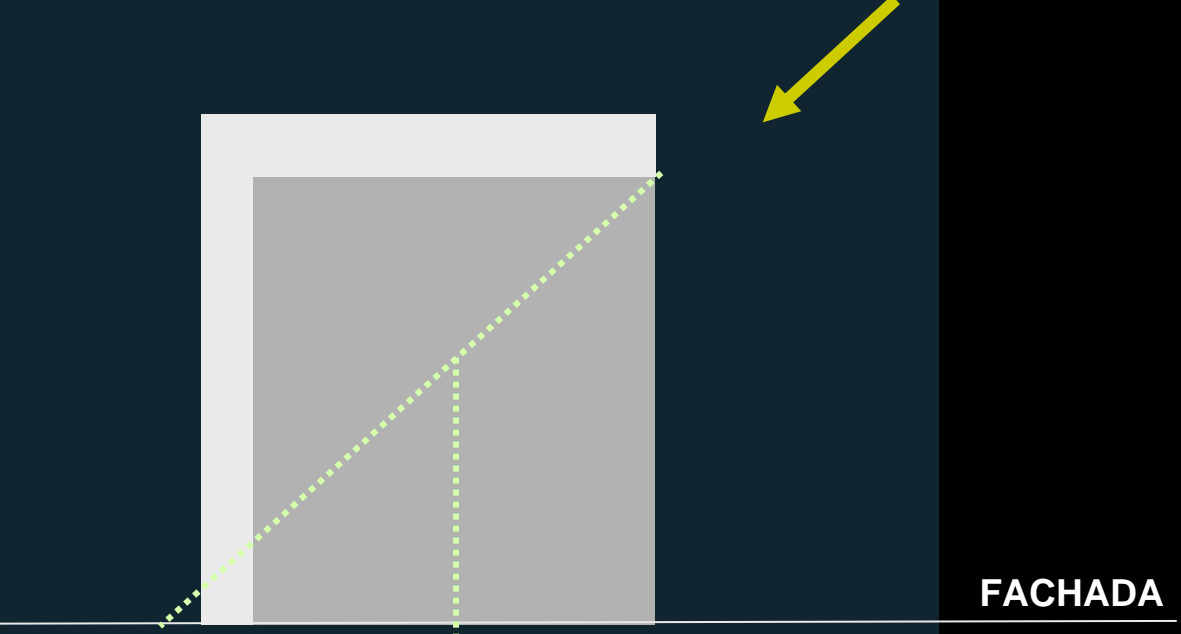

FACHADA

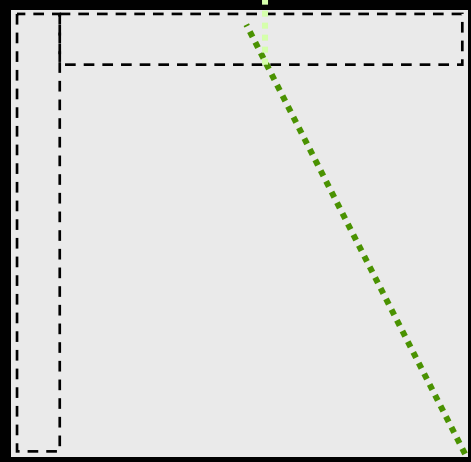

PLANTA

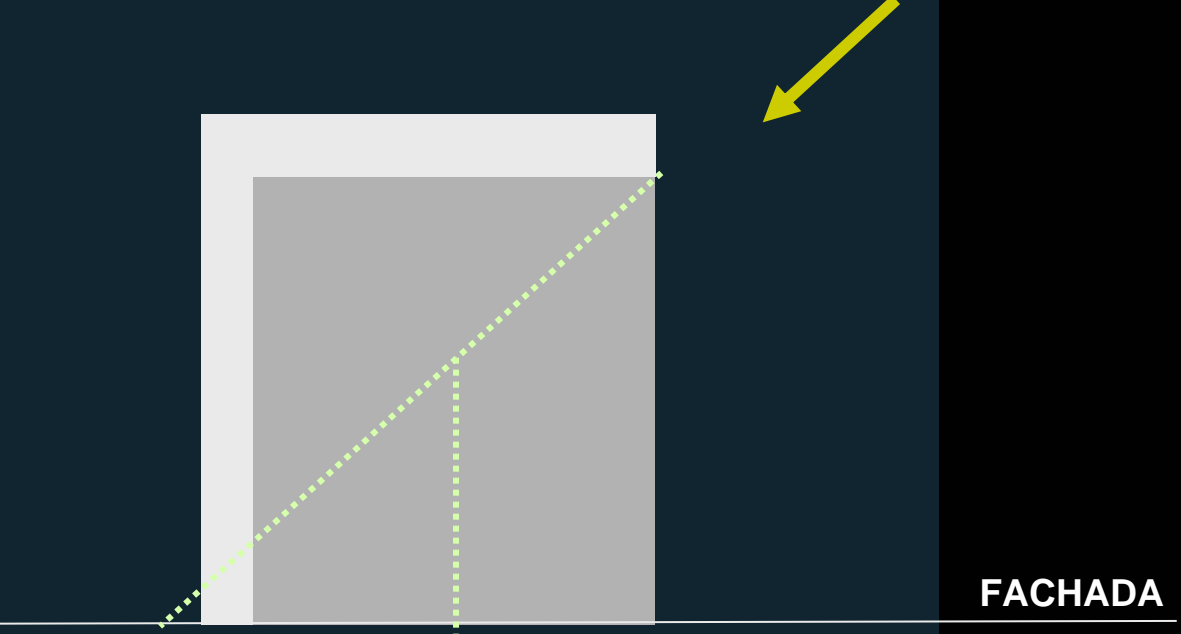

FACHADA

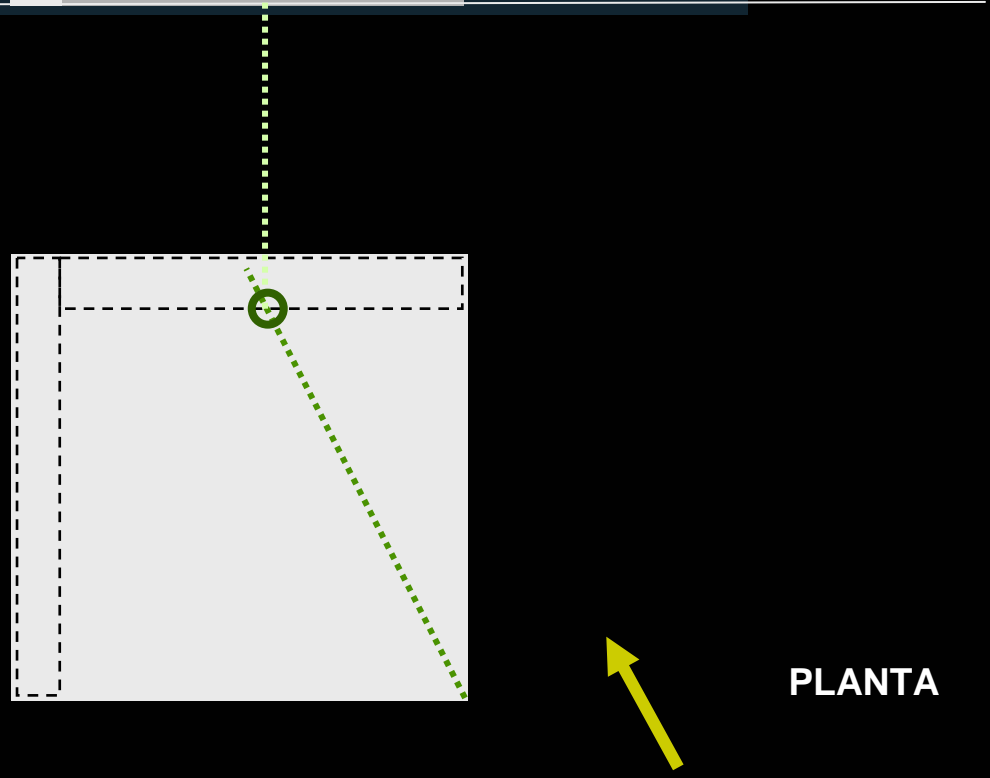

PLANTA

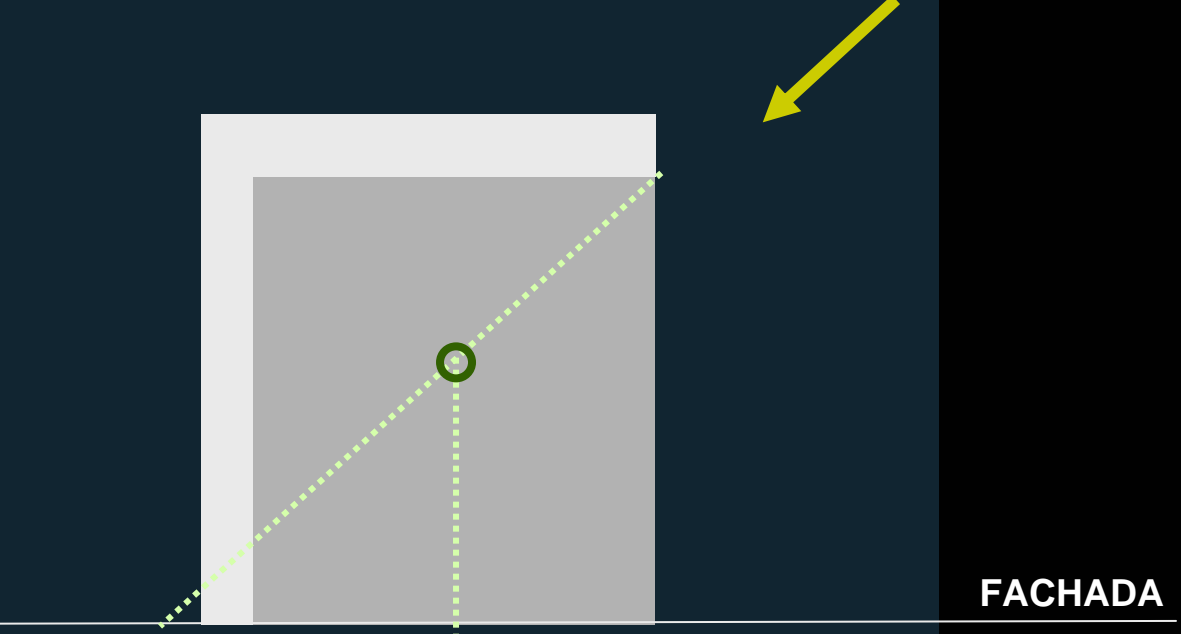

FACHADA

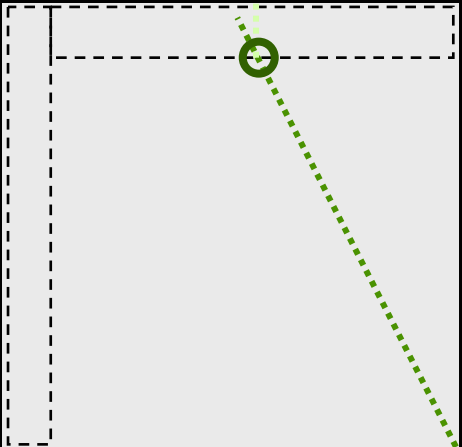

PLANTA

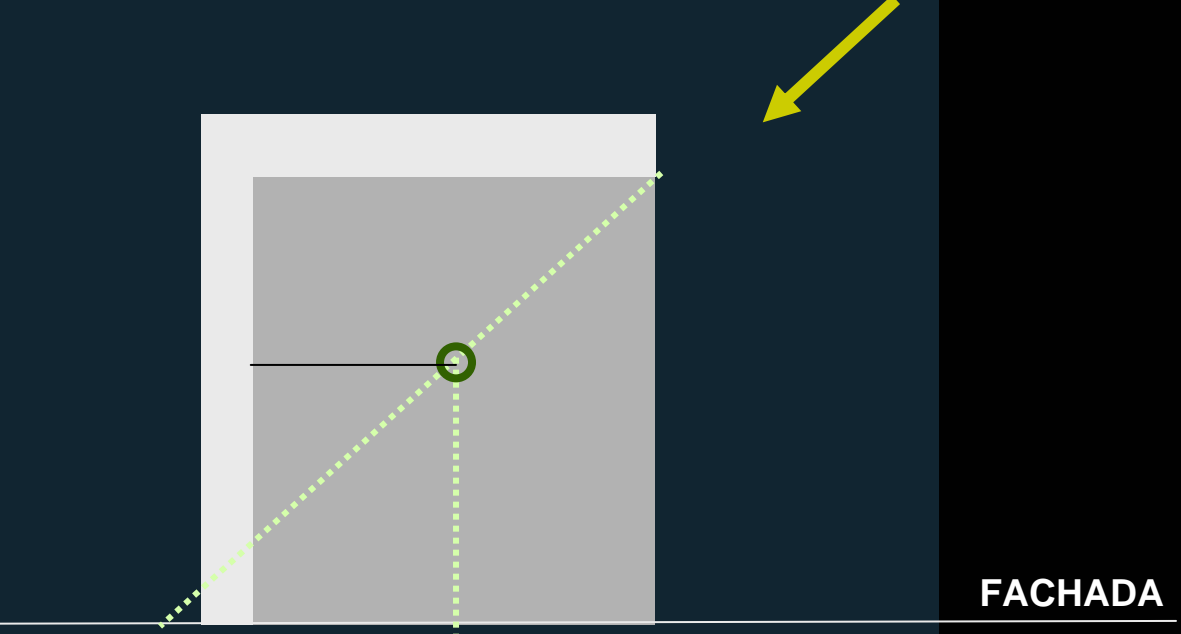

FACHADA

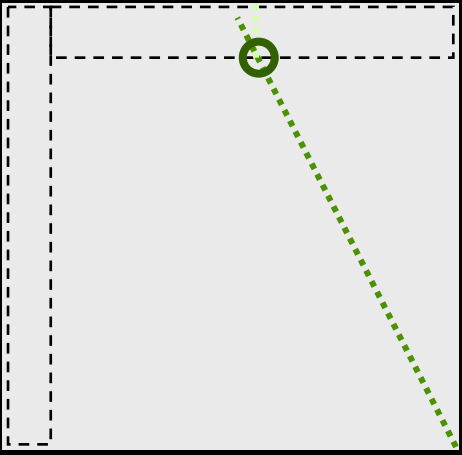

PLANTA

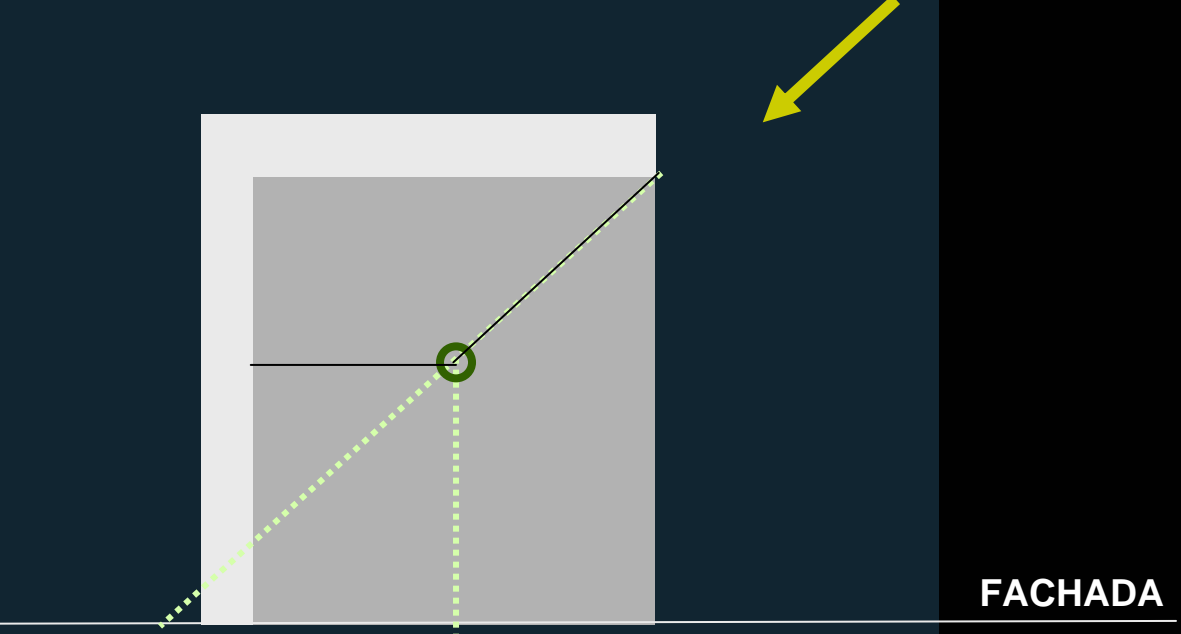

FACHADA

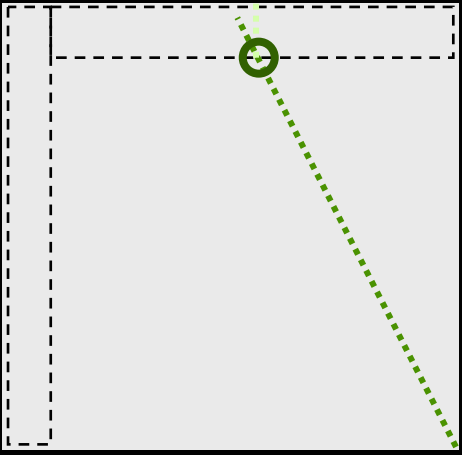

PLANTA

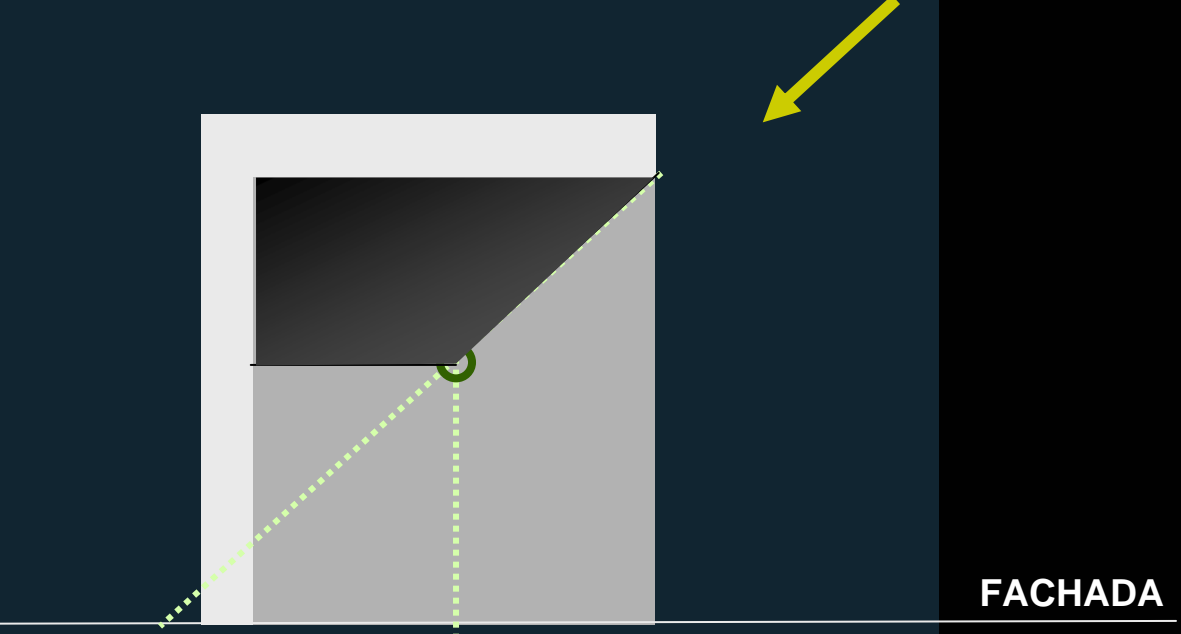

FACHADA

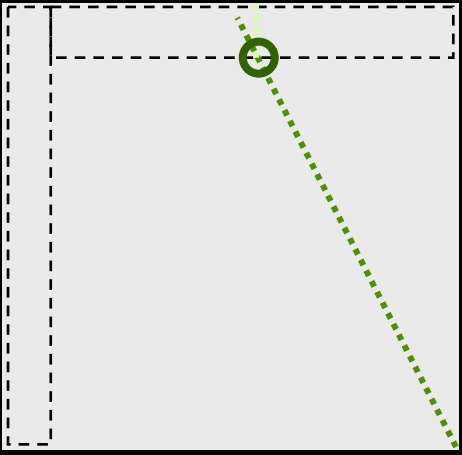

PLANTA

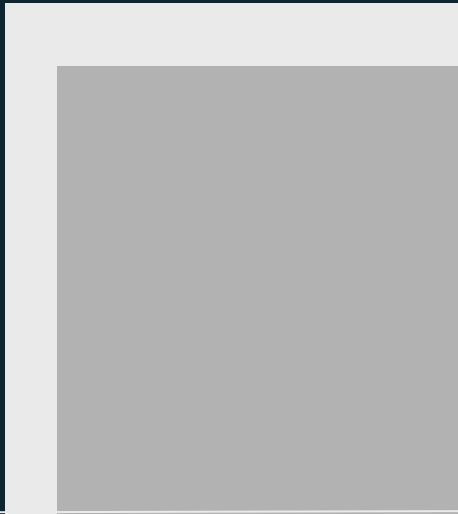

A

FACHADA

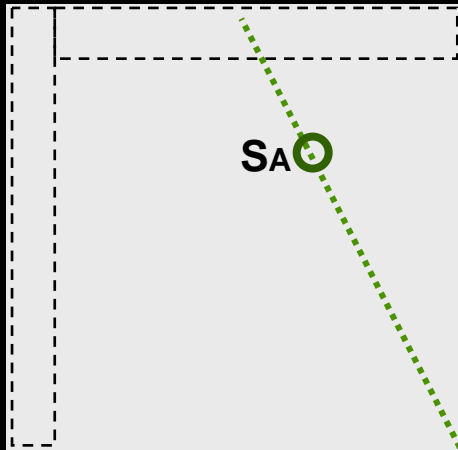

SA



PLANTA

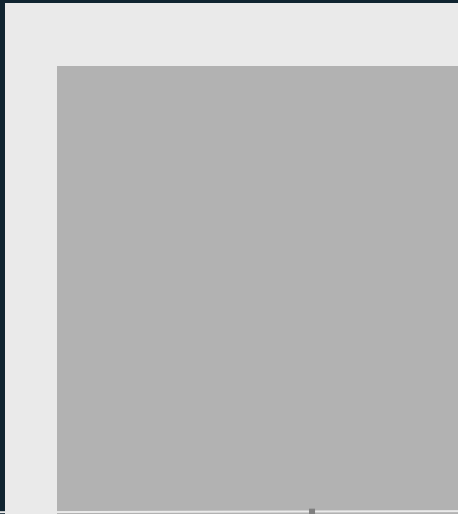

A

FACHADA

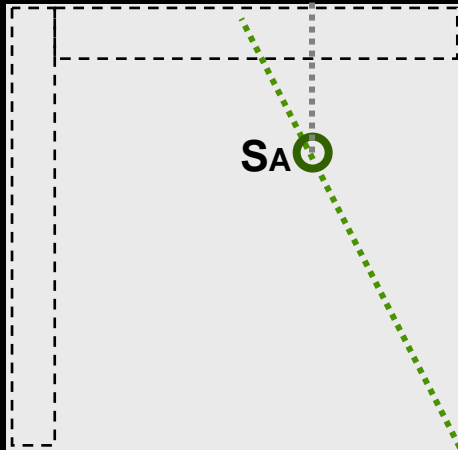

SAO

PLANTA



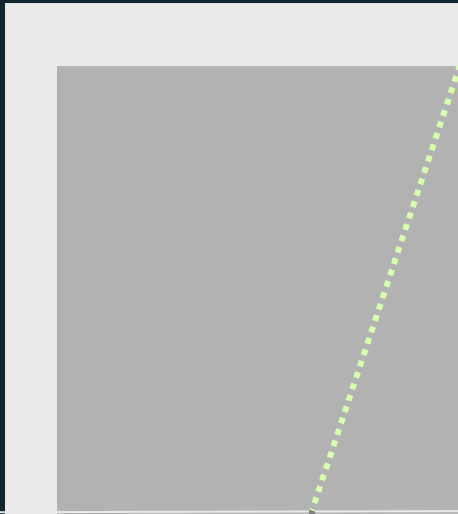

A



FACHADA

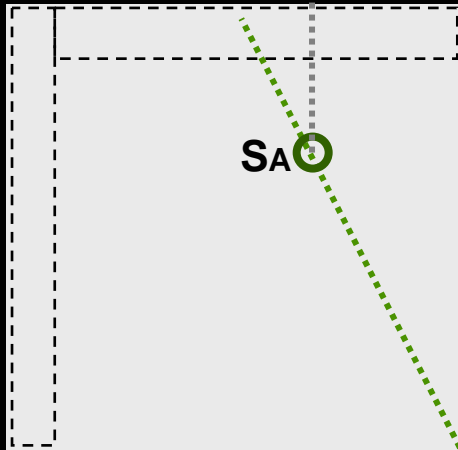

SA



PLANTA

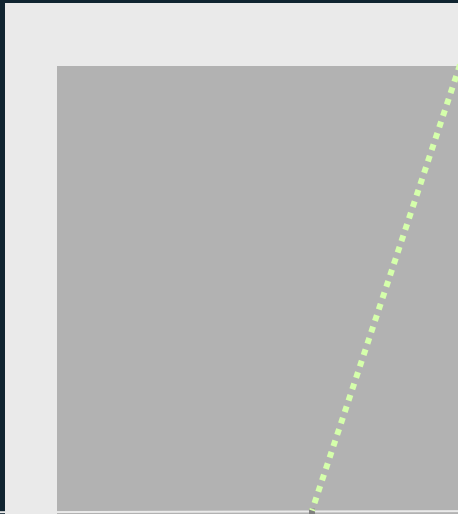

A



FACHADA

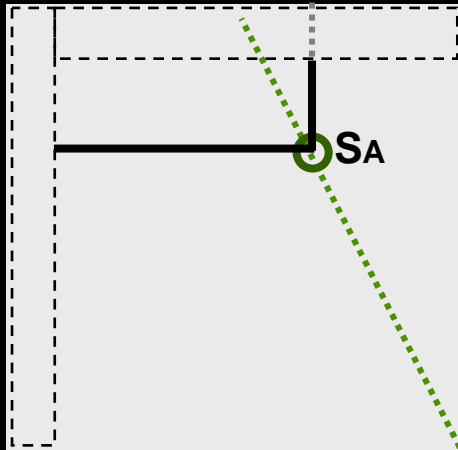

SA



PLANTA

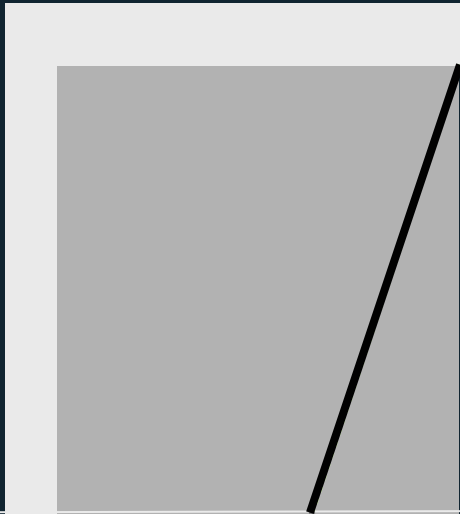

A



FACHADA

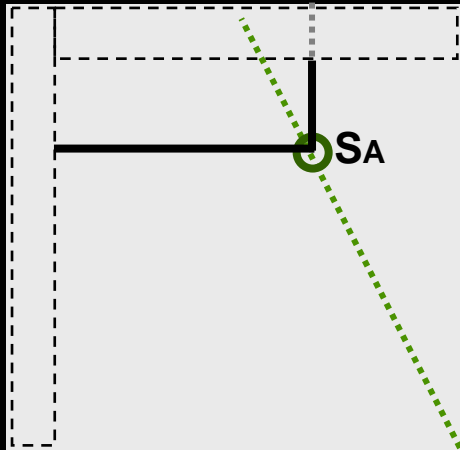

SA



PLANTA



FACHADA

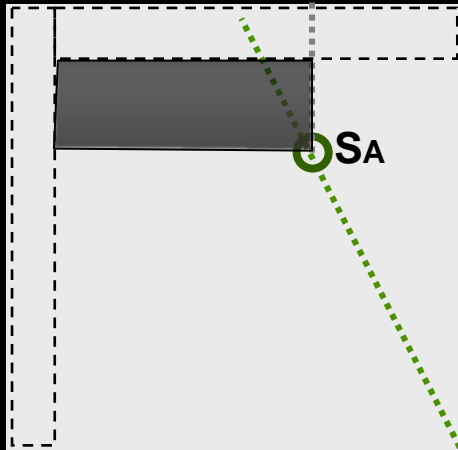

PLANTA



A



FACHADA

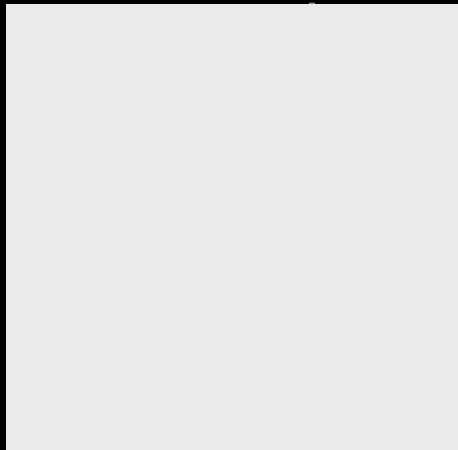

PLANTA



A



FACHADA

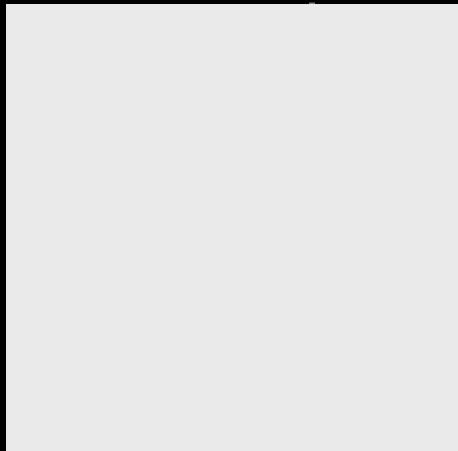
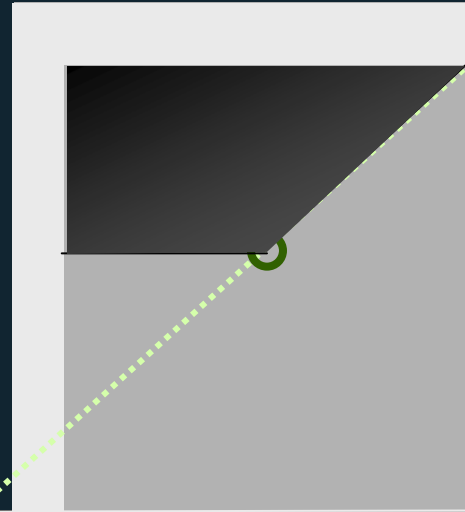

PLANTA





FACHADA

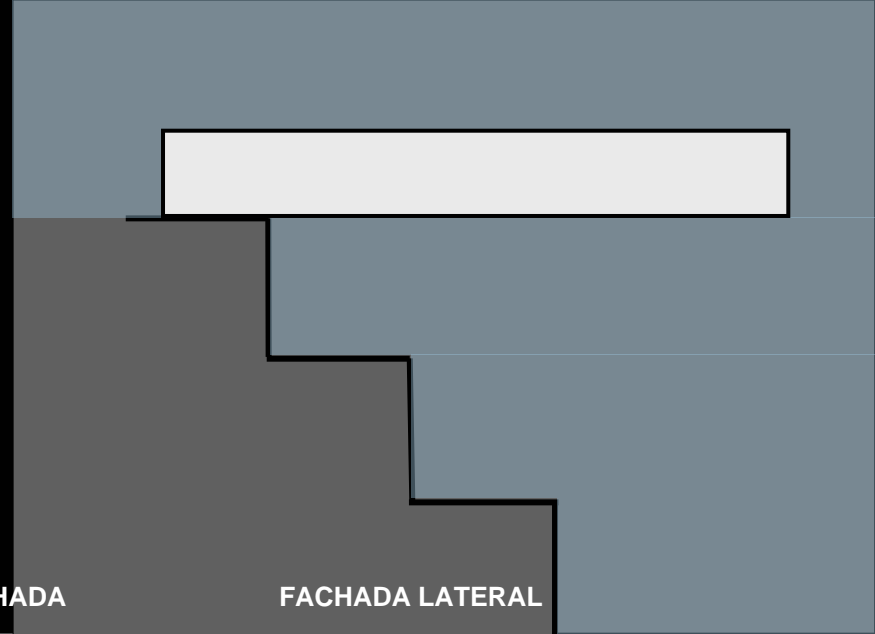

FACHADA LATERAL

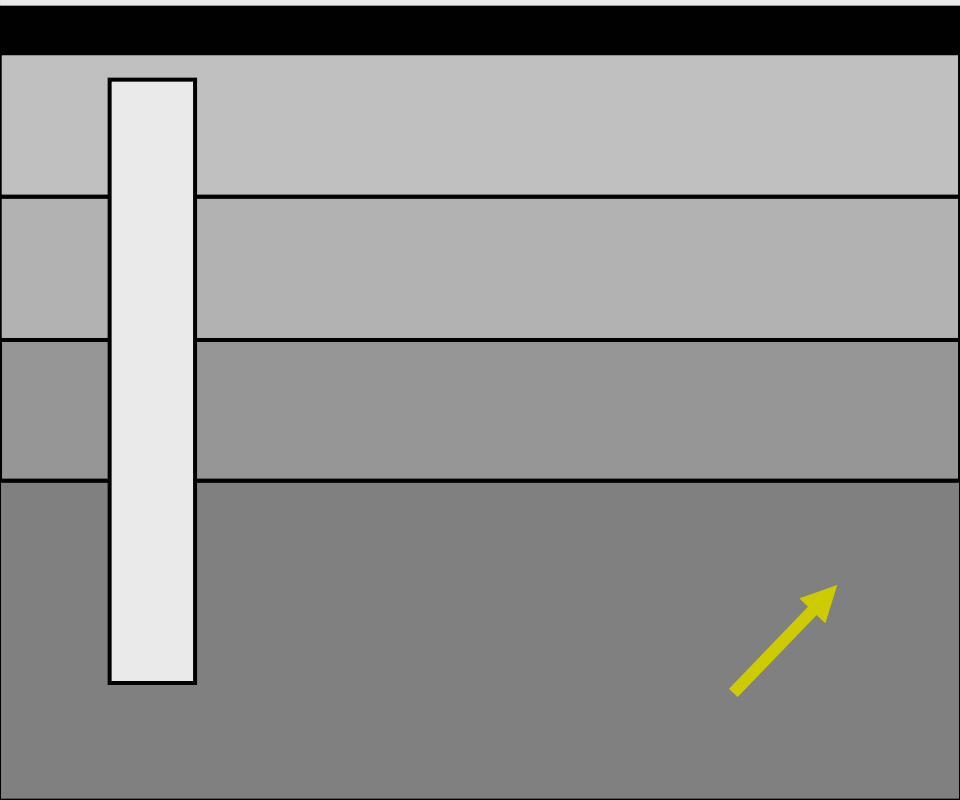

PLANTA

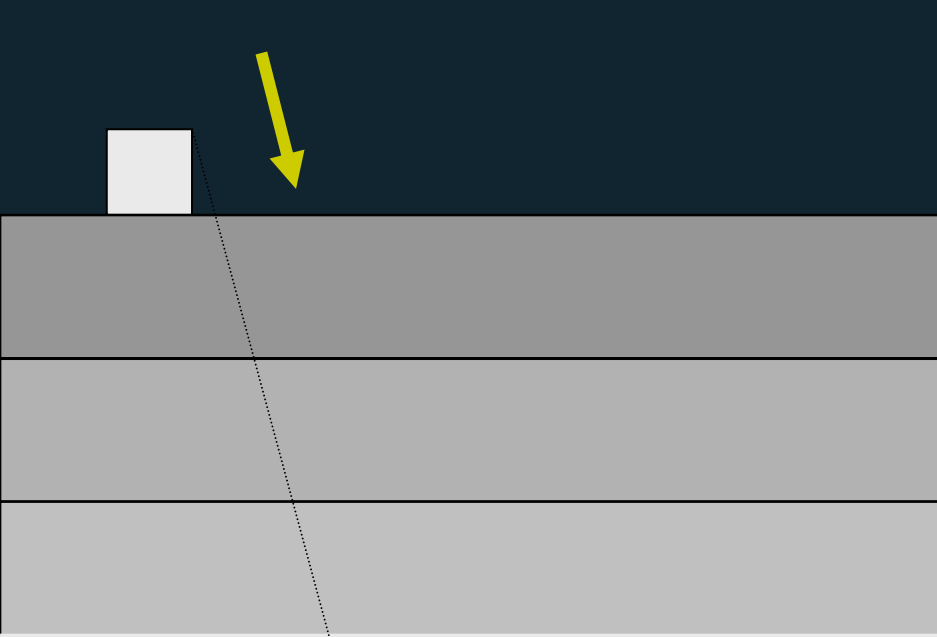

FACHADA

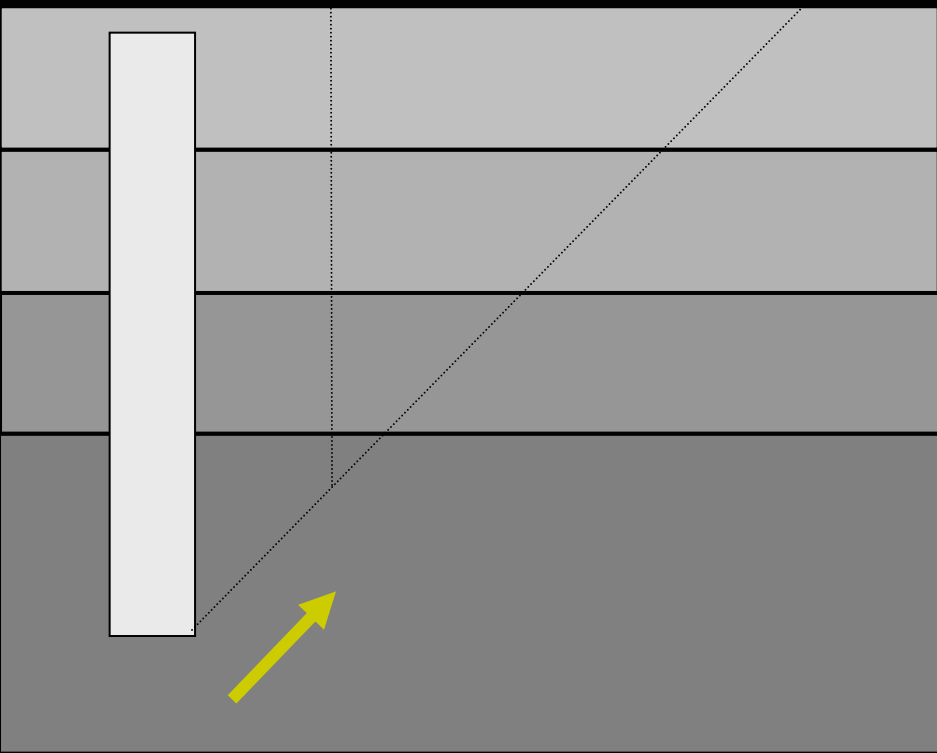

PLANTA

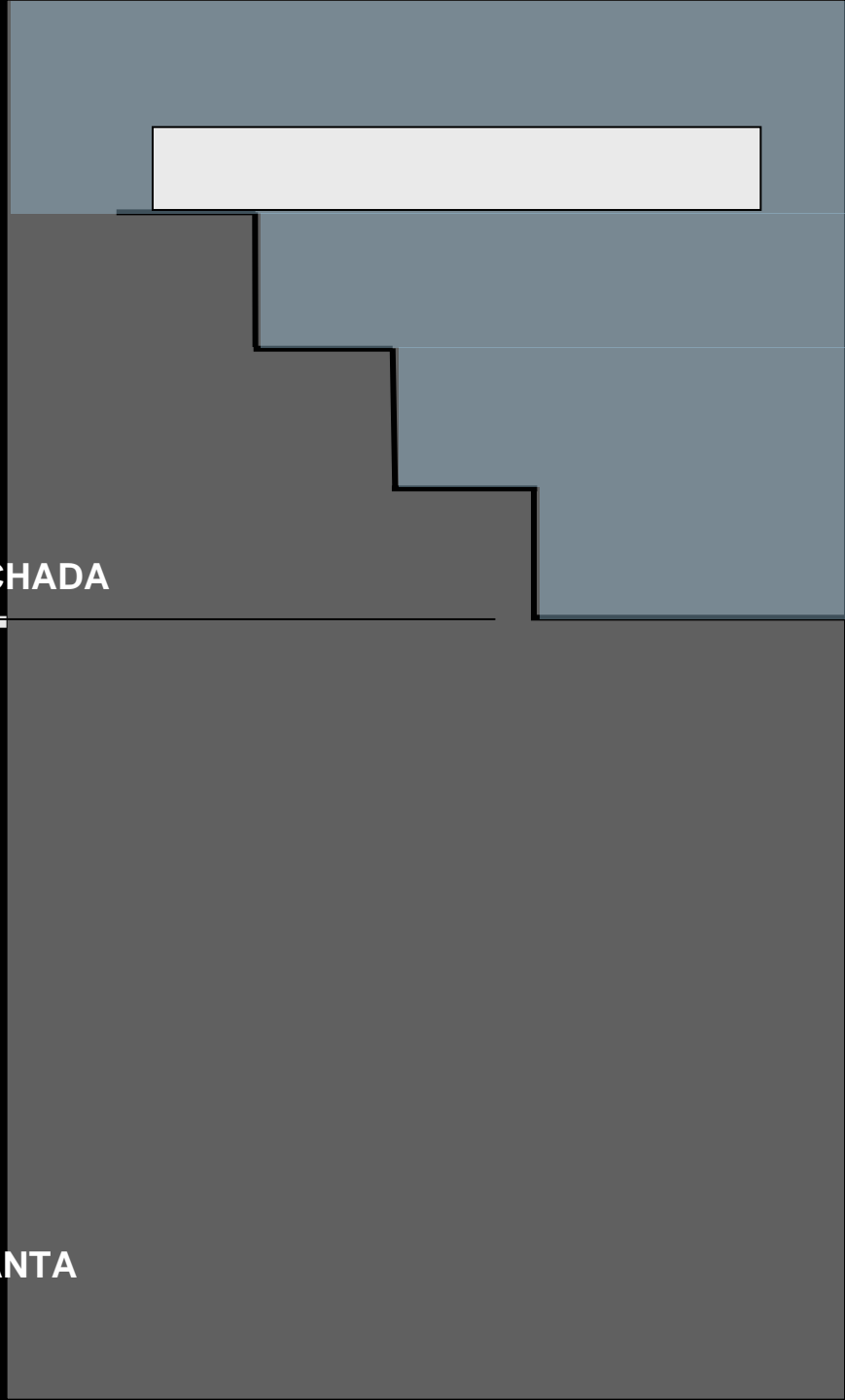

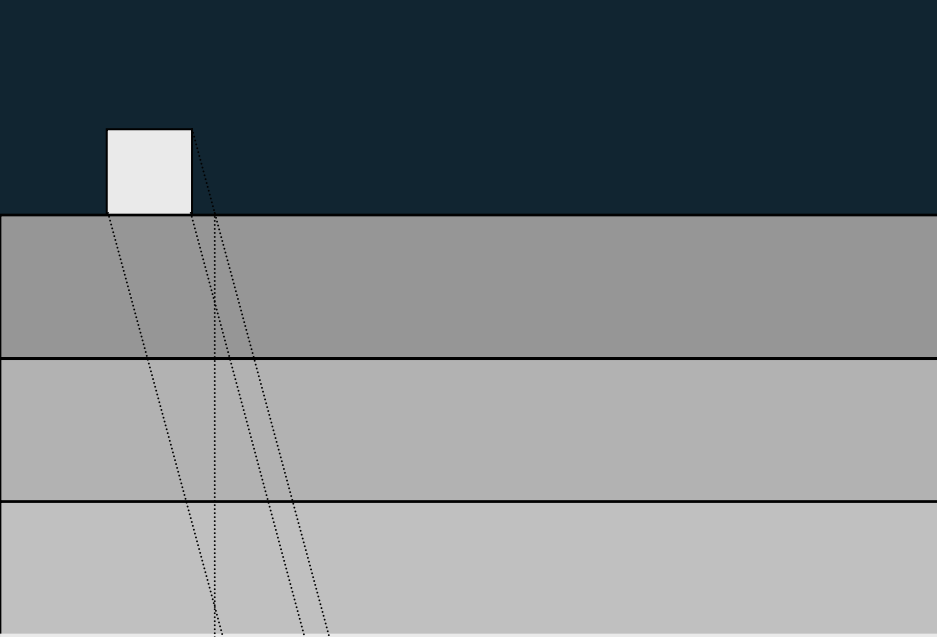

FACHADA

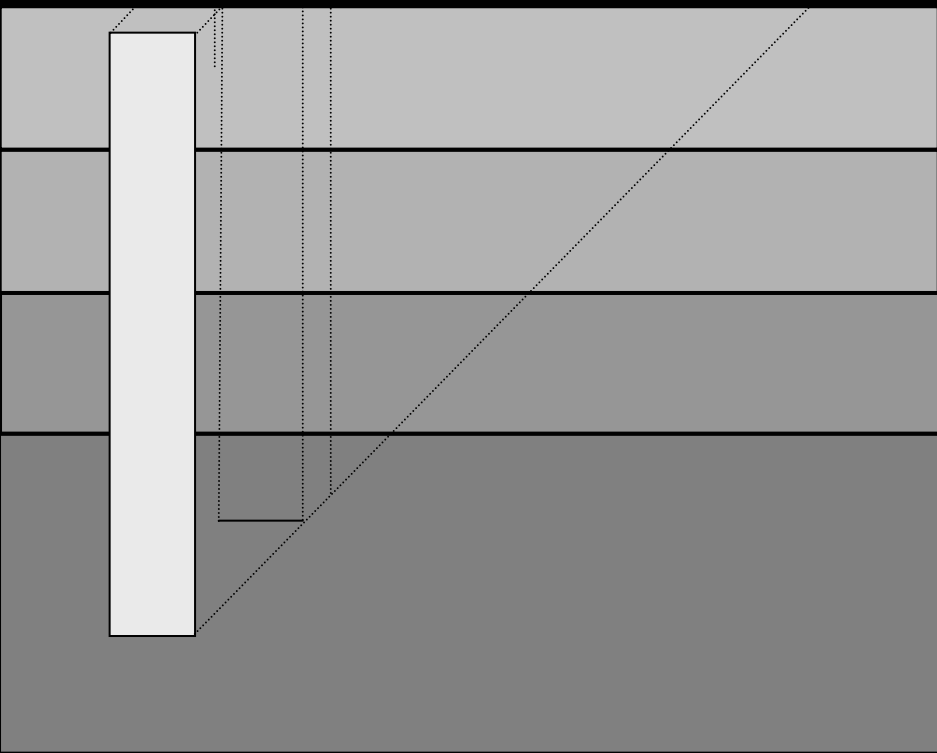

PLANTA

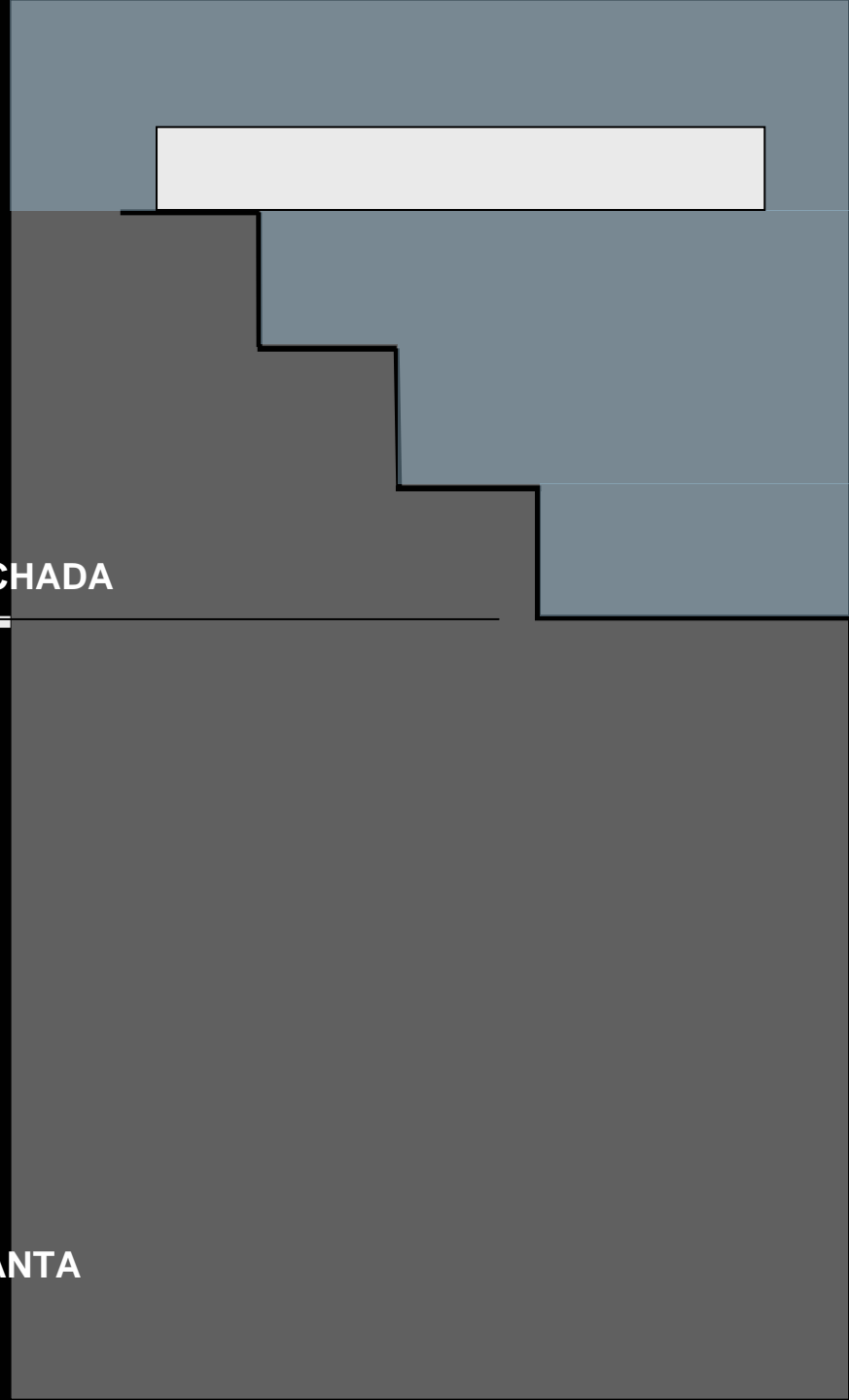

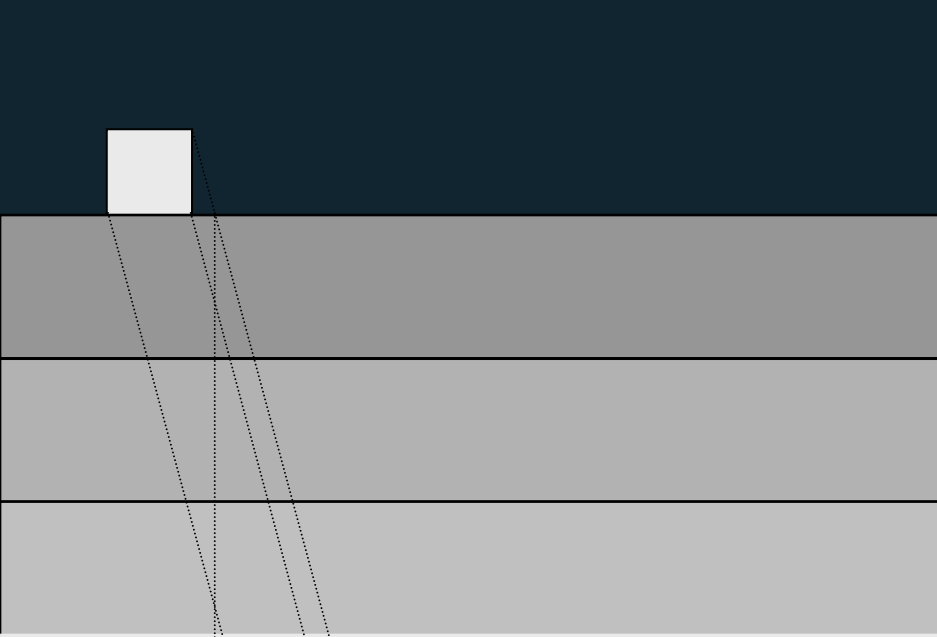

FACHADA

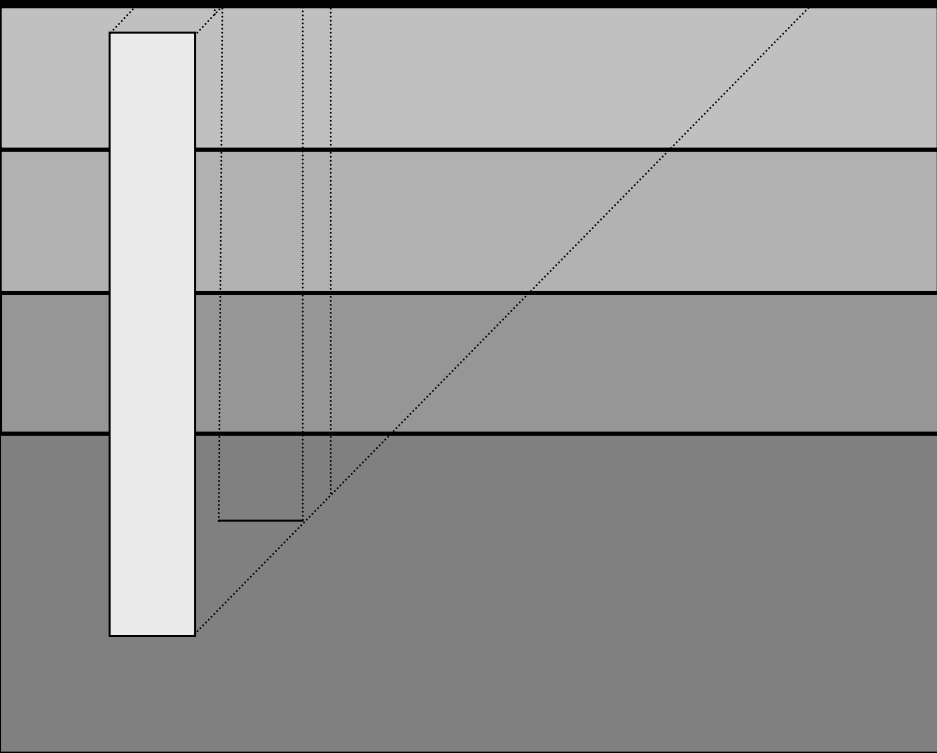

PLANTA

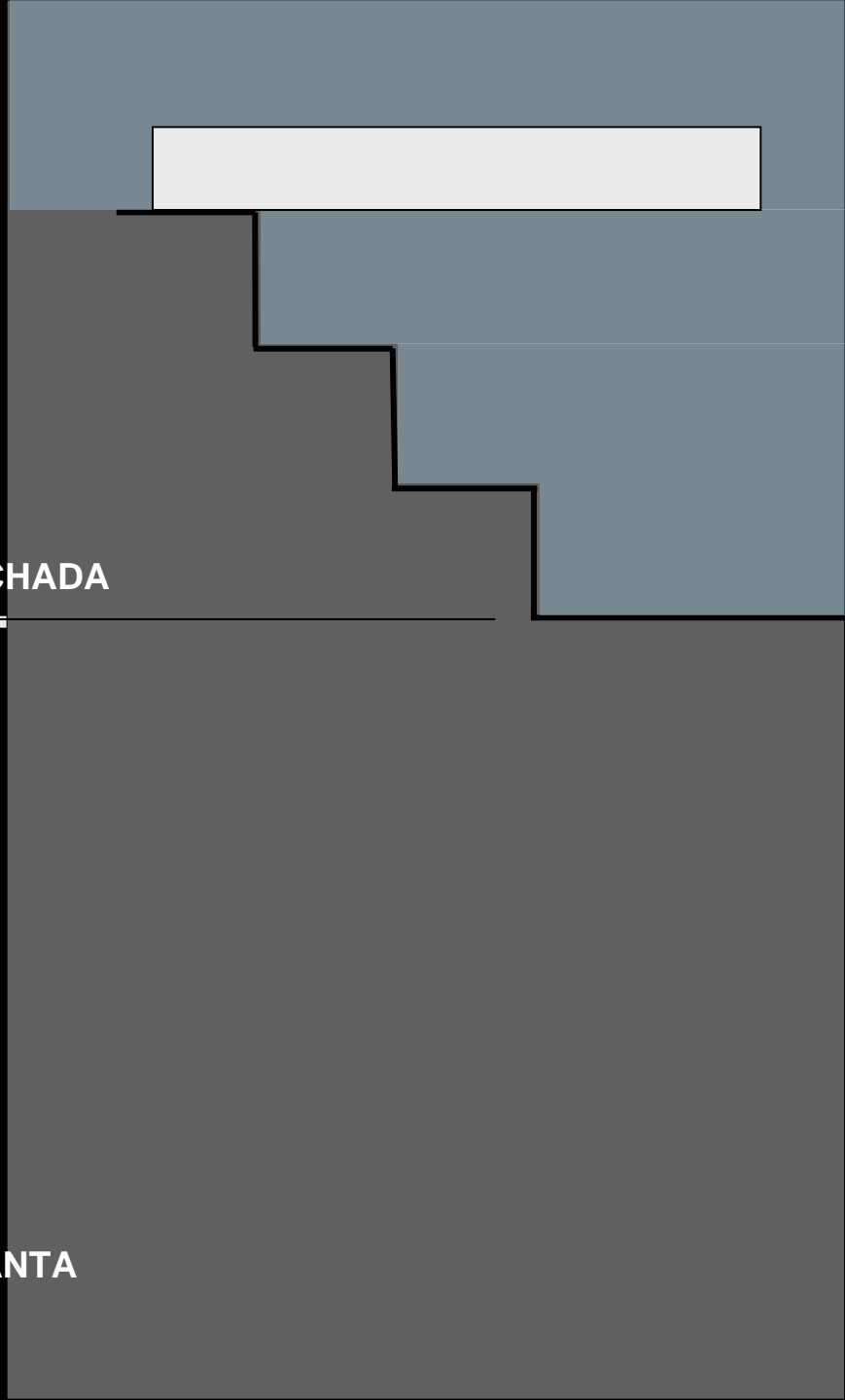

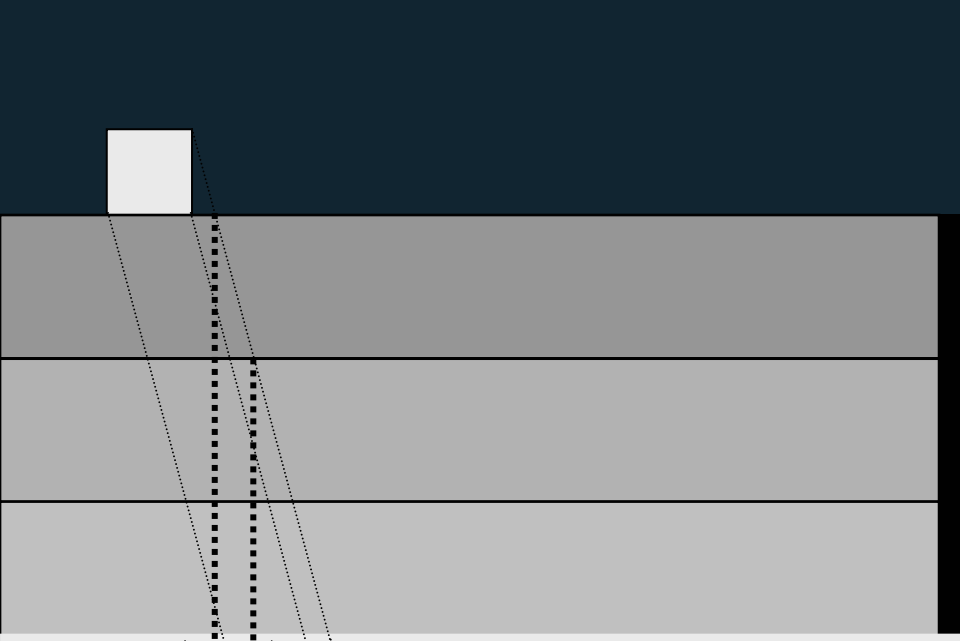

FACHADA

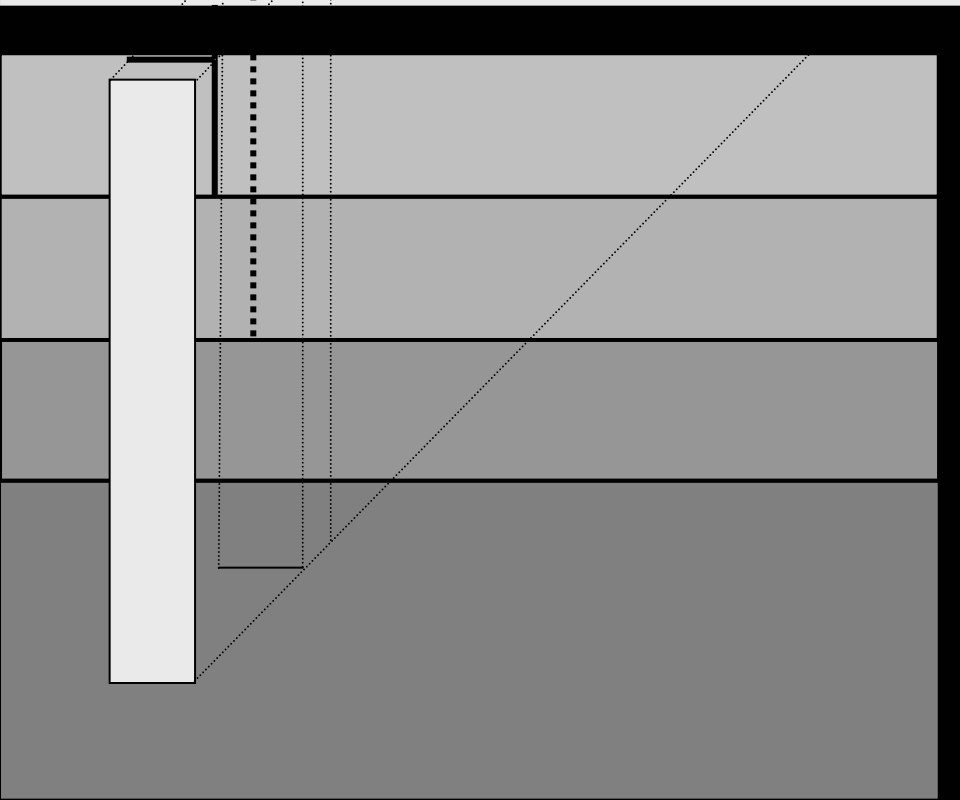

PLANTA

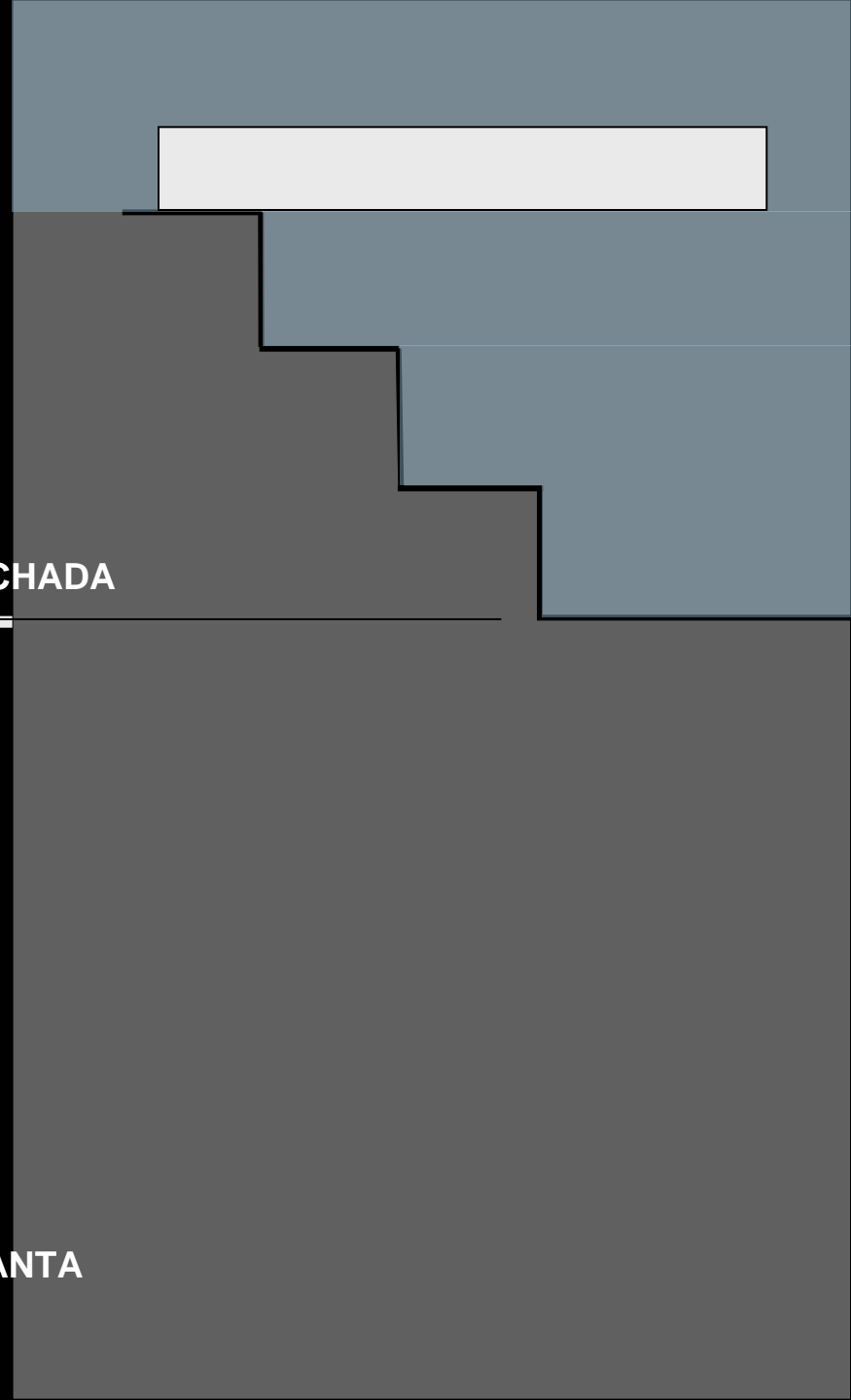

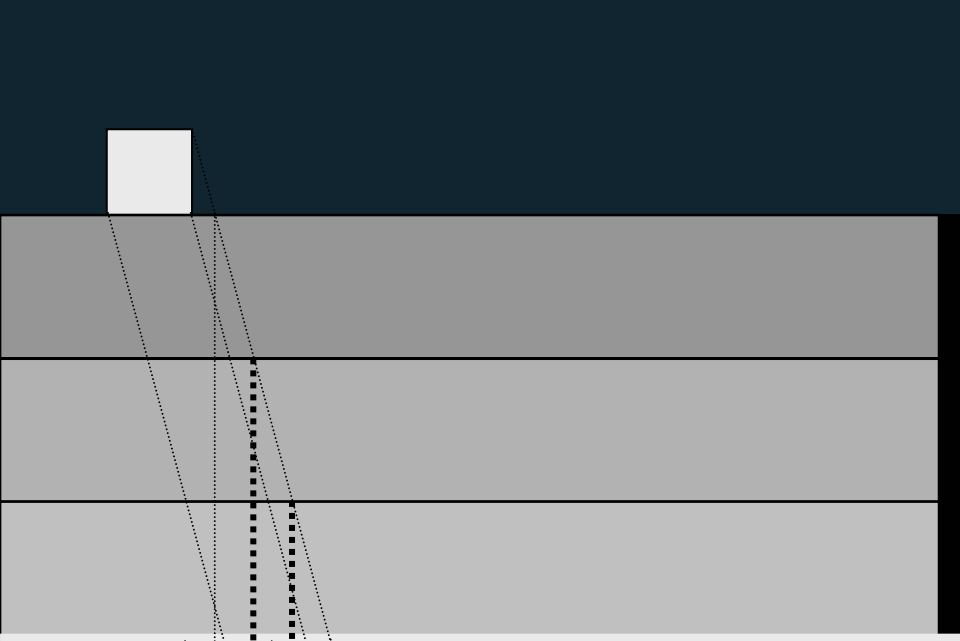

FACHADA

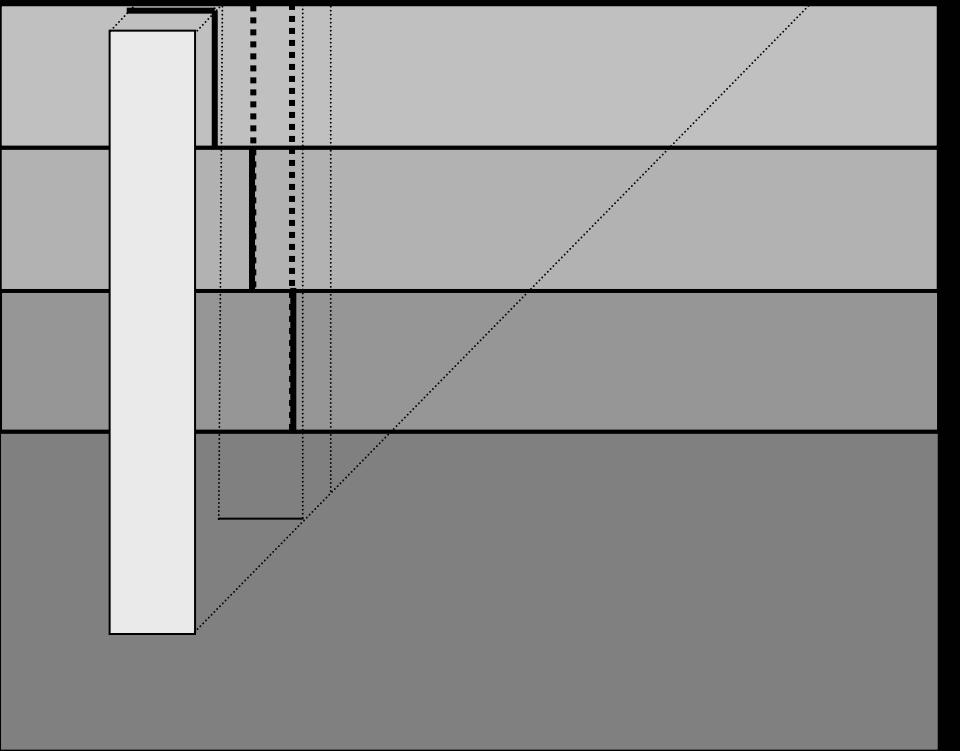

PLANTA

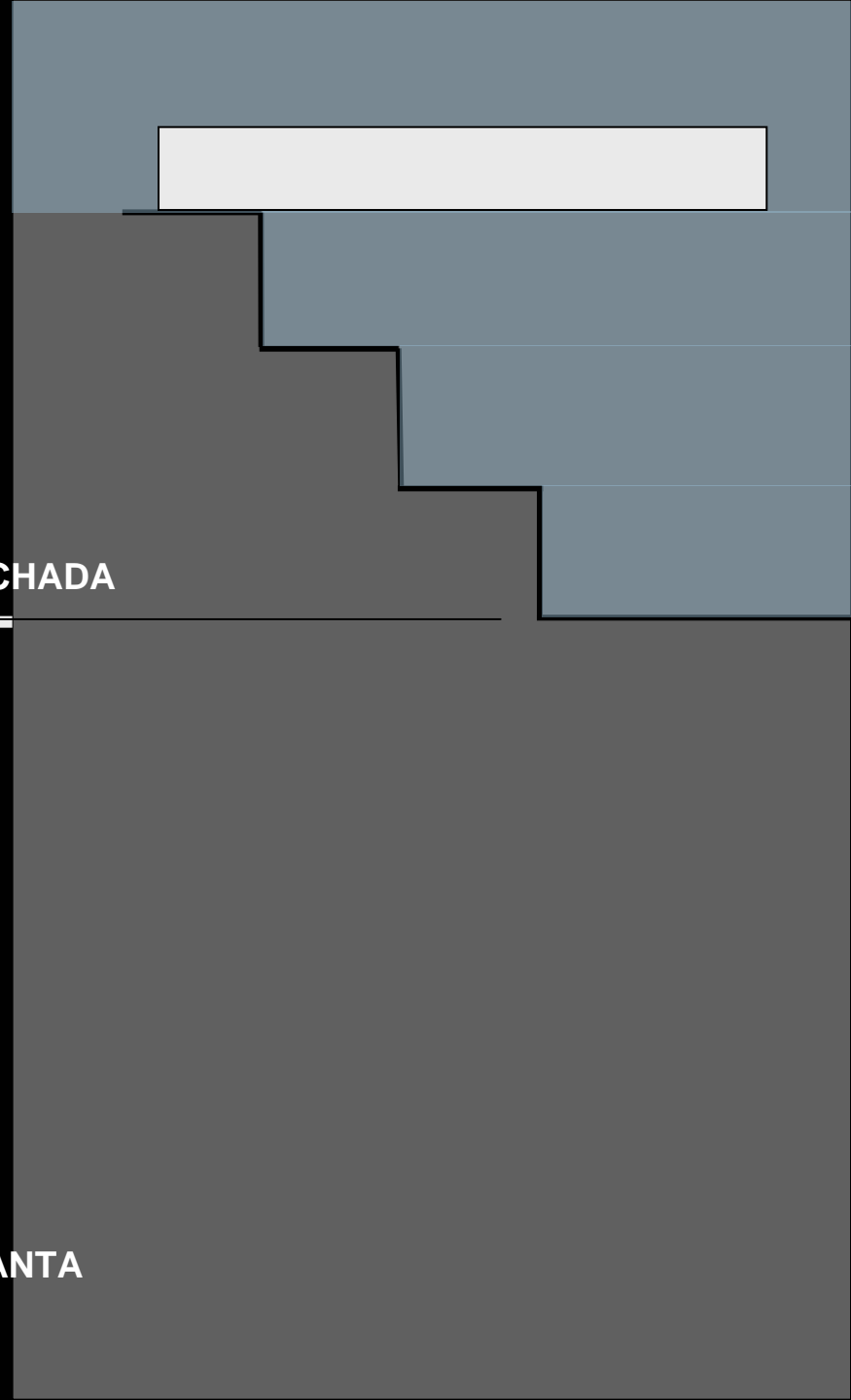

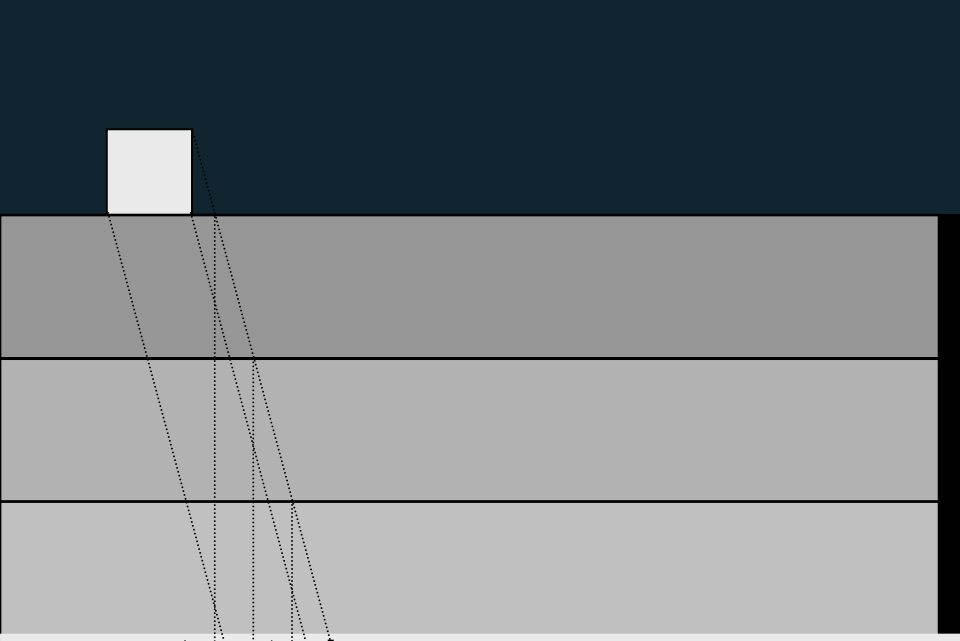

FACHADA

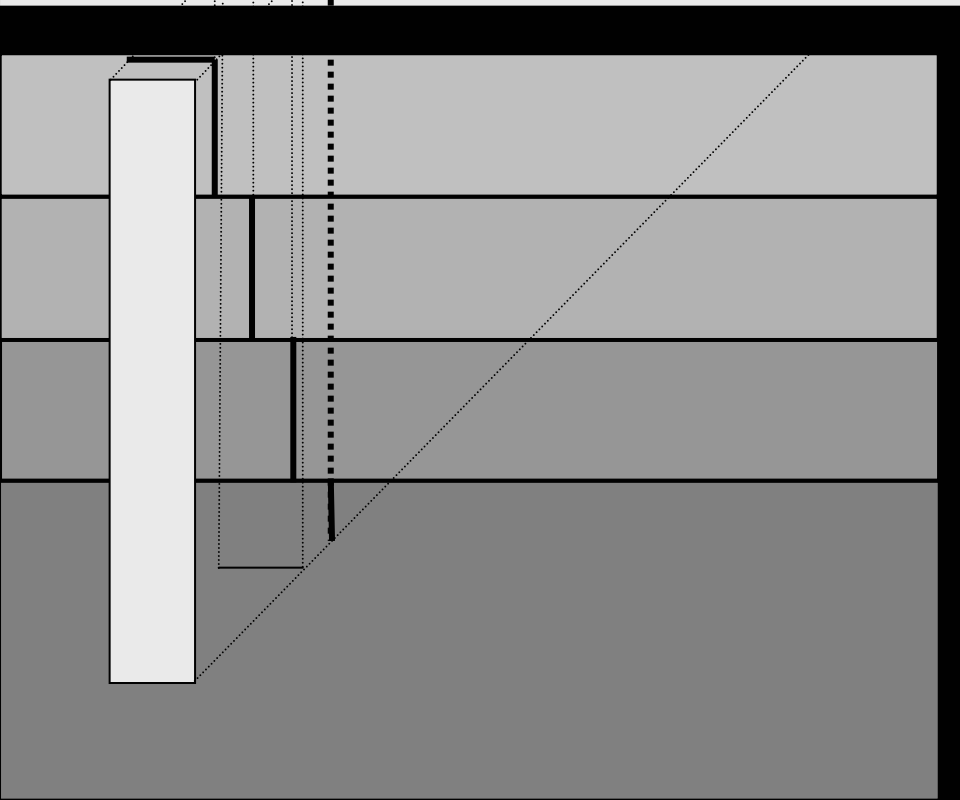

PLANTA

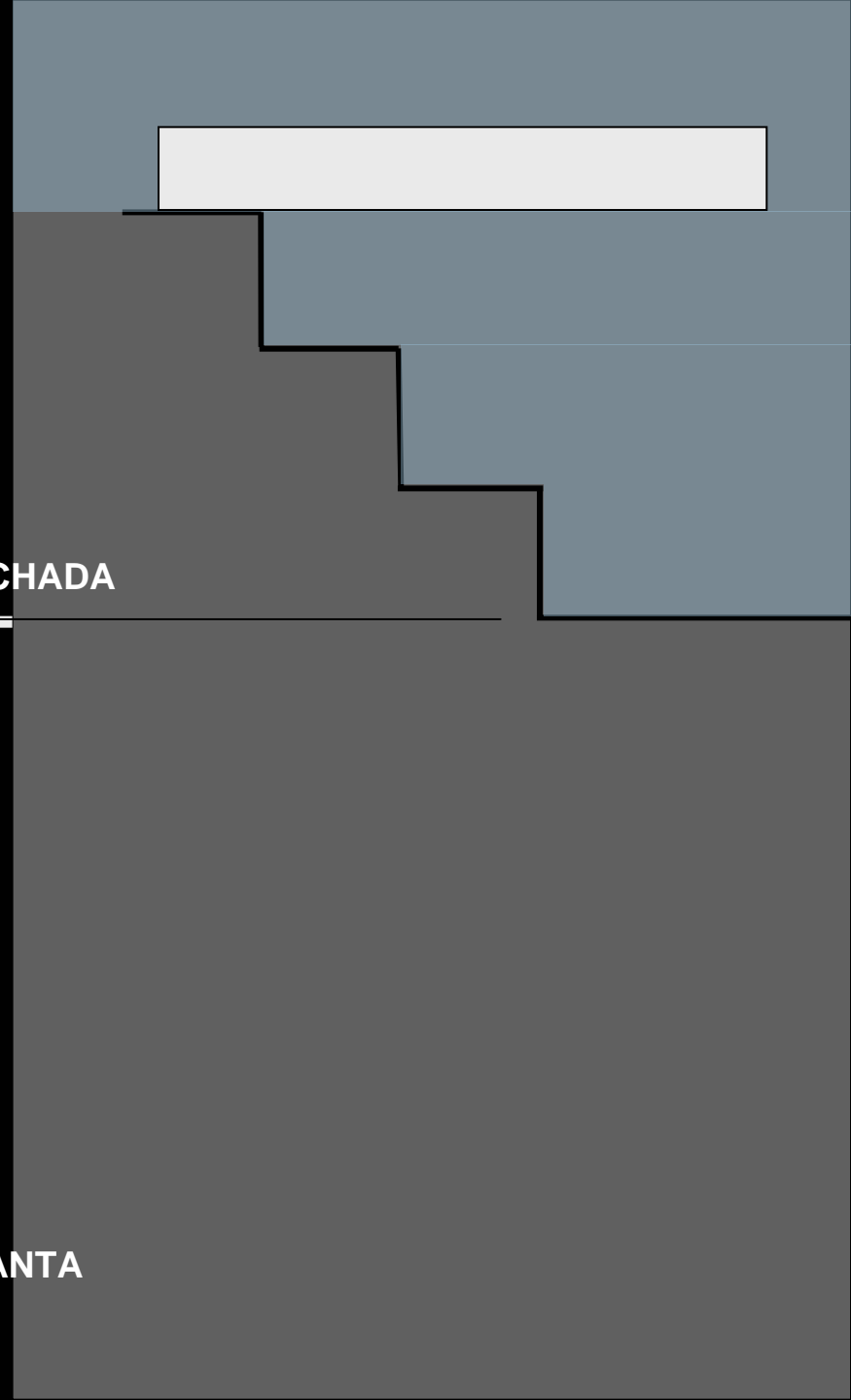

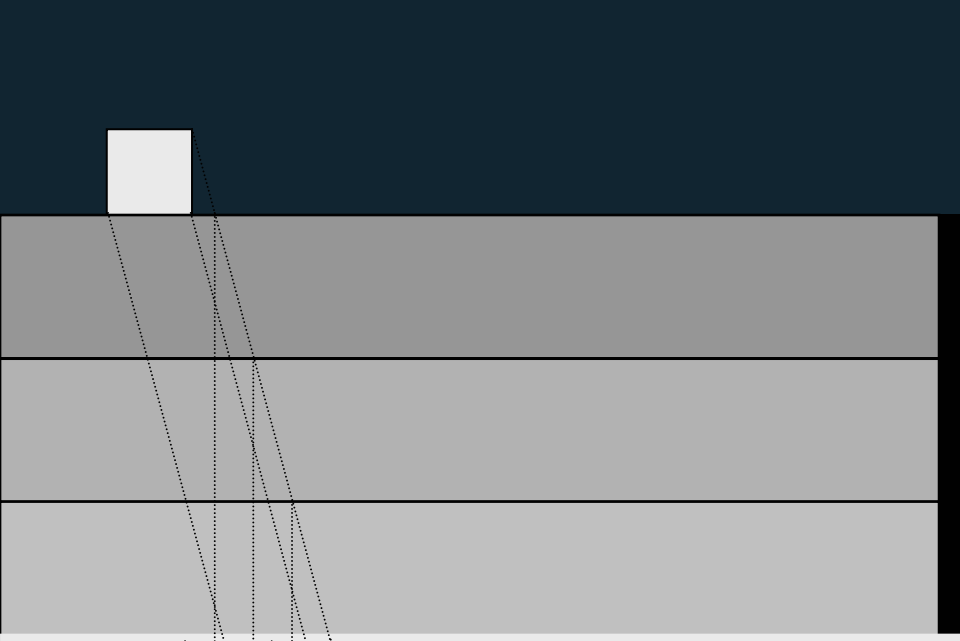

FACHADA

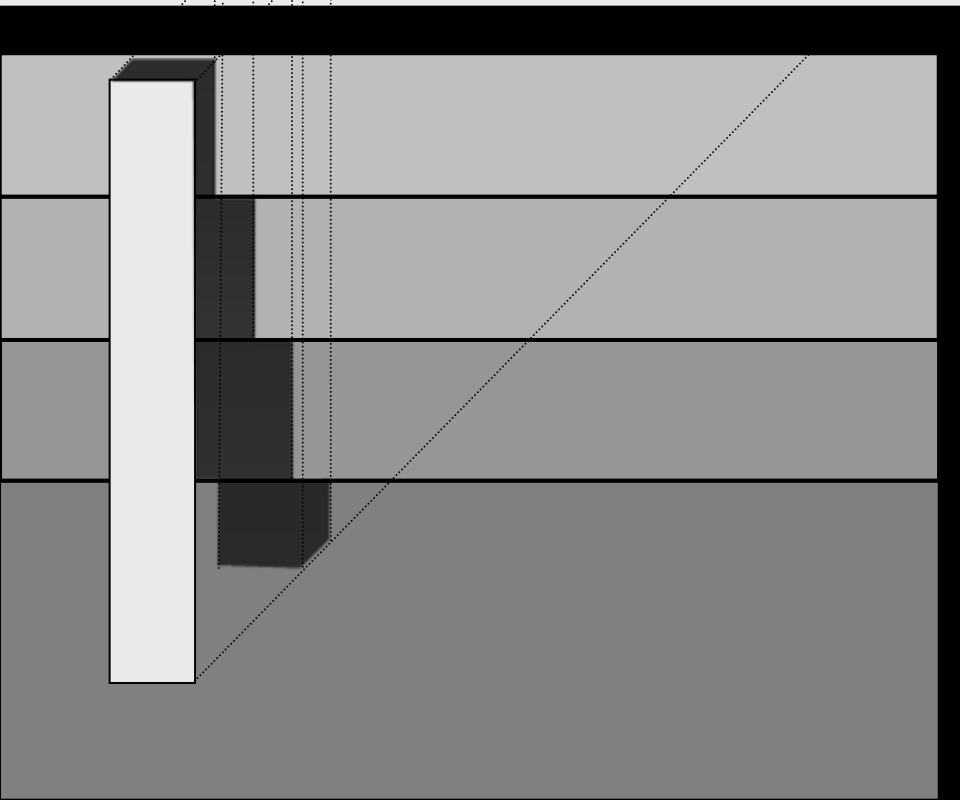

PLANTA

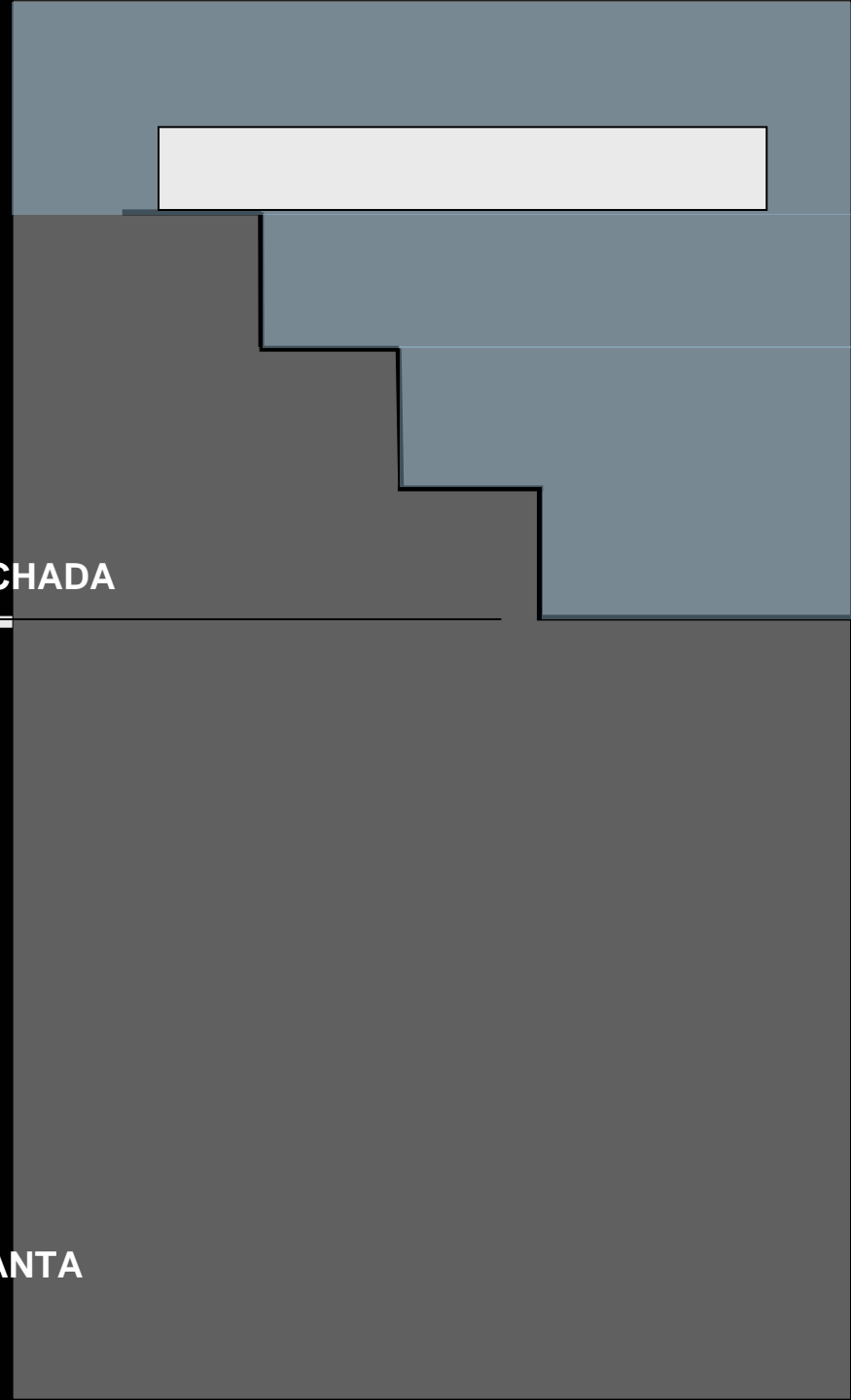

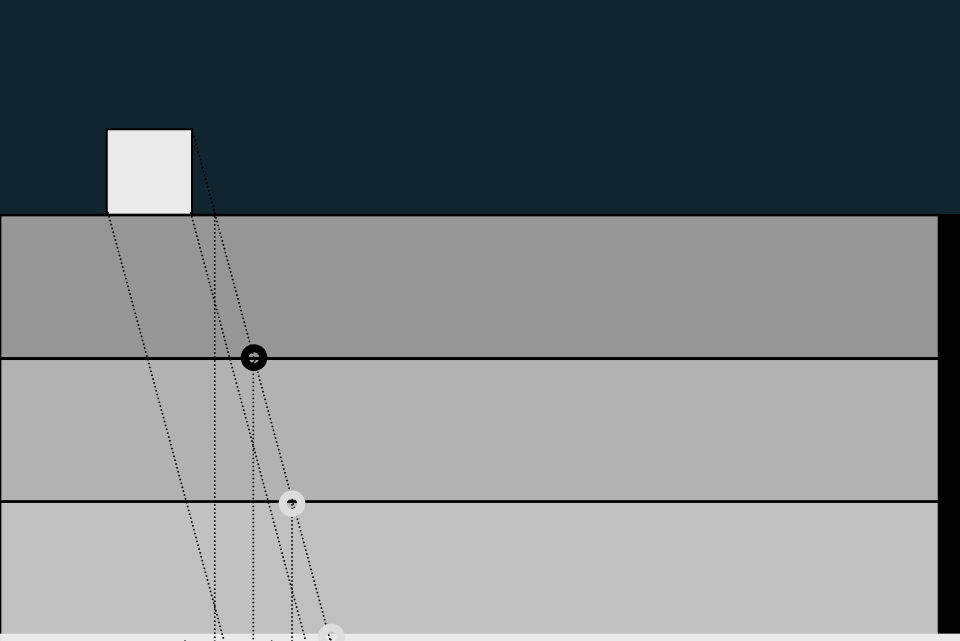

FACHADA

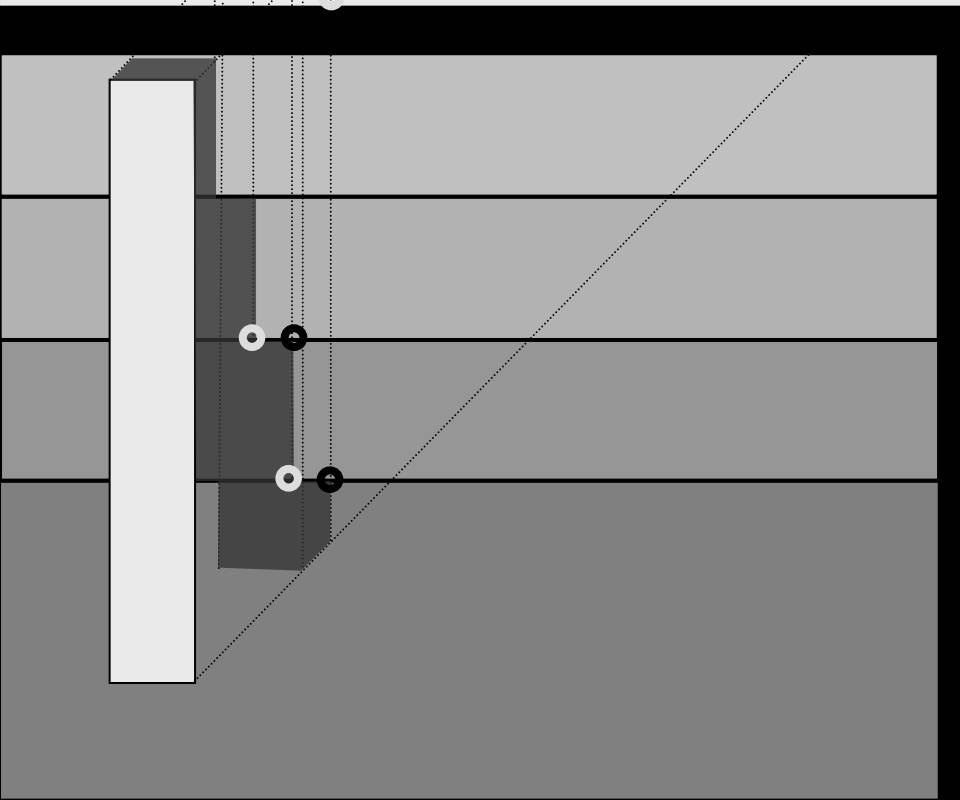

PLANTA

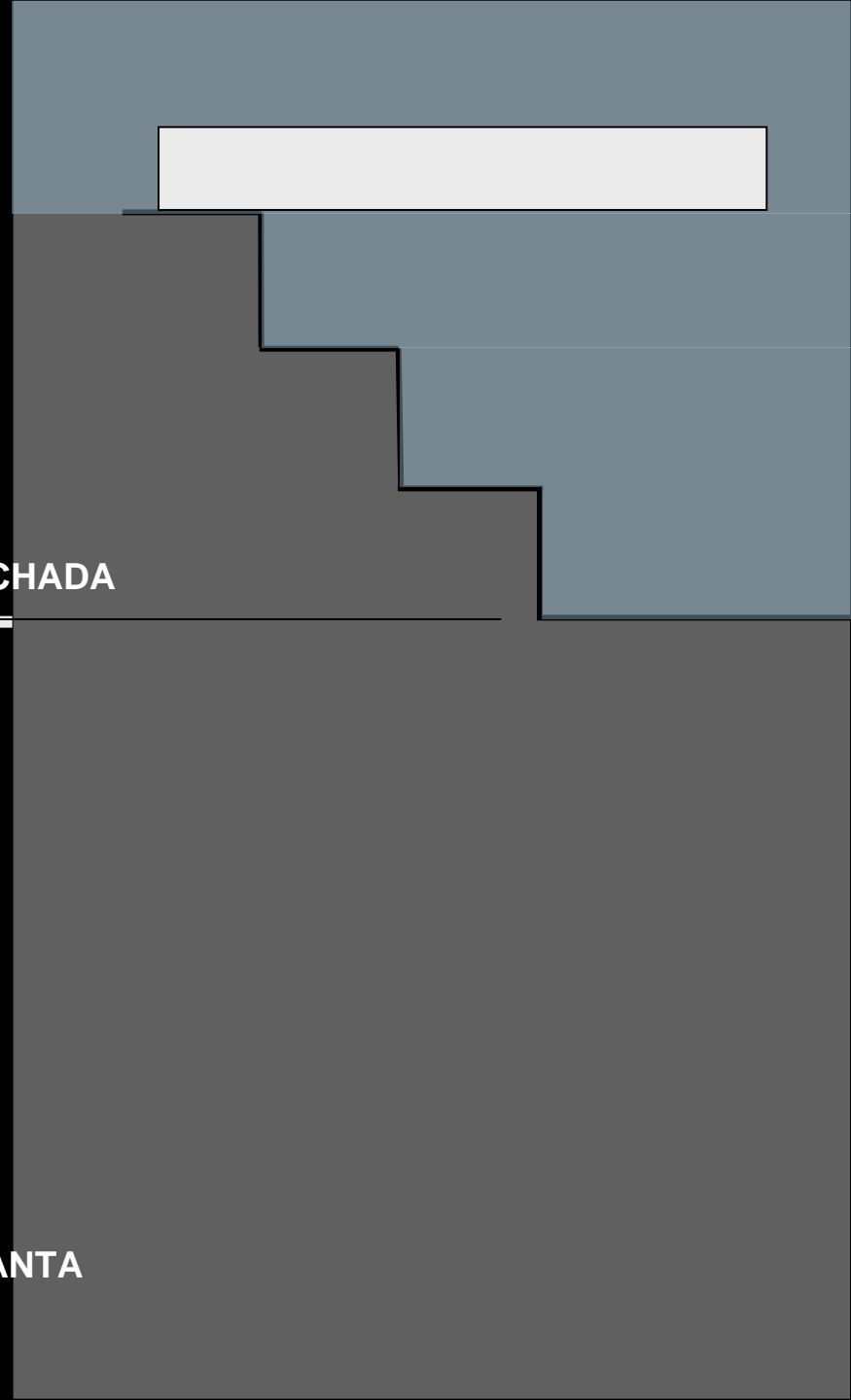

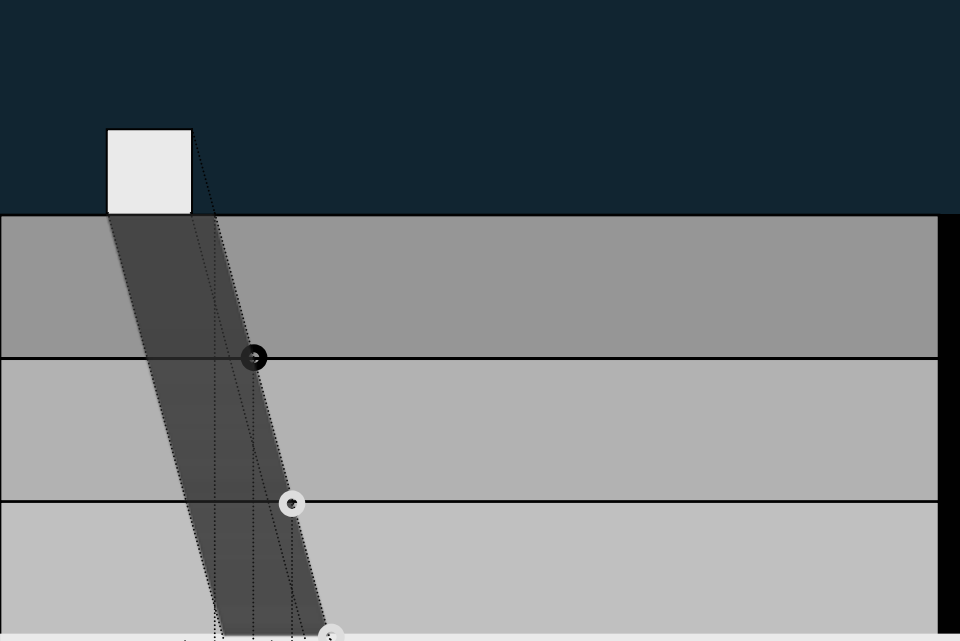

FACHADA

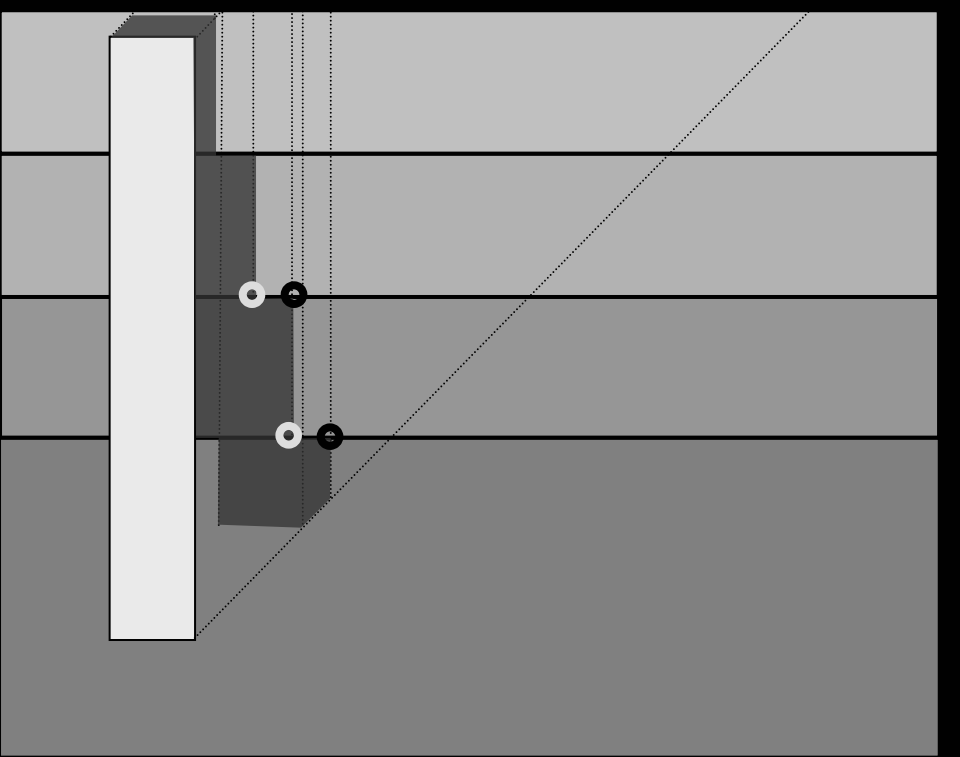

PLANTA

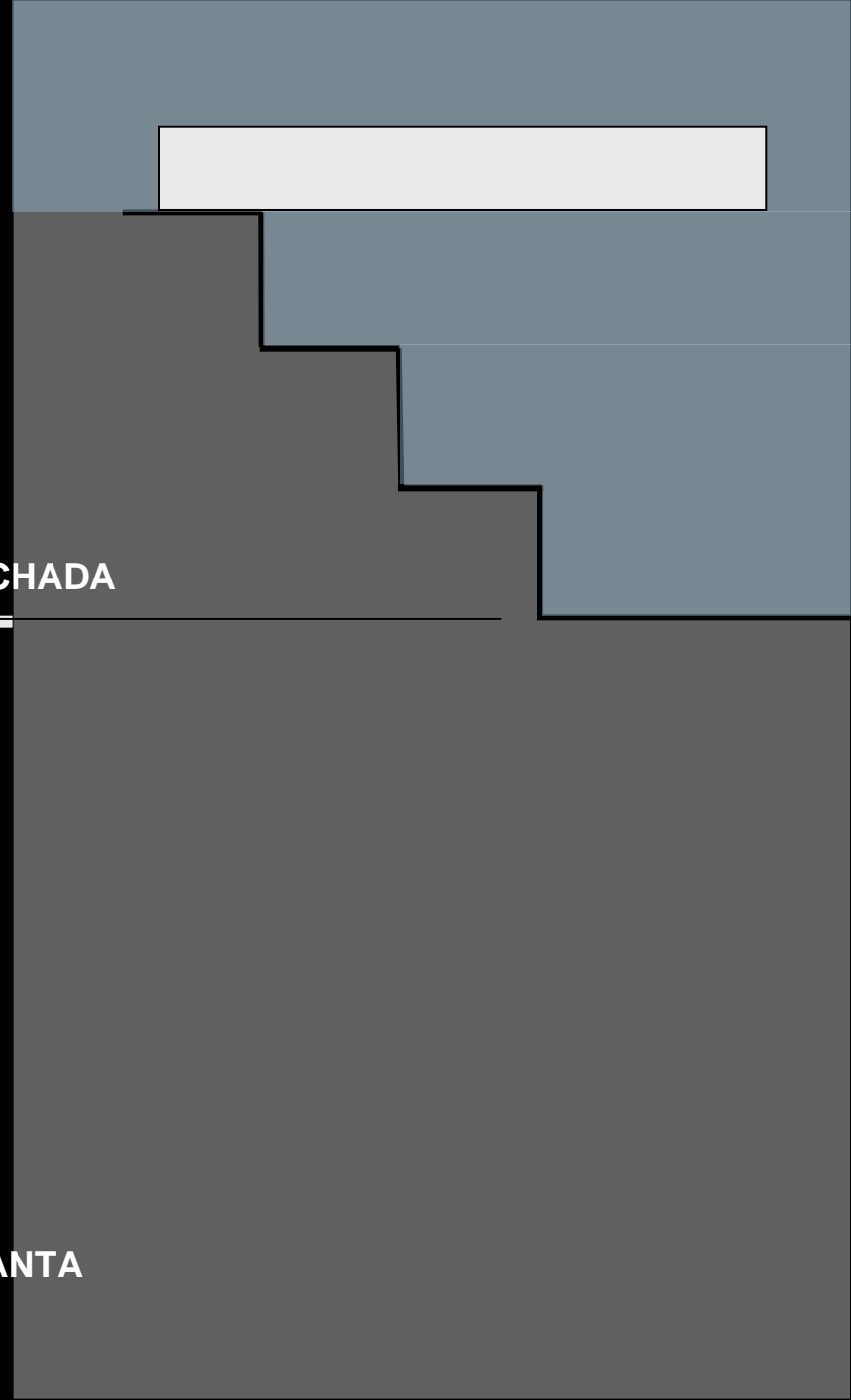

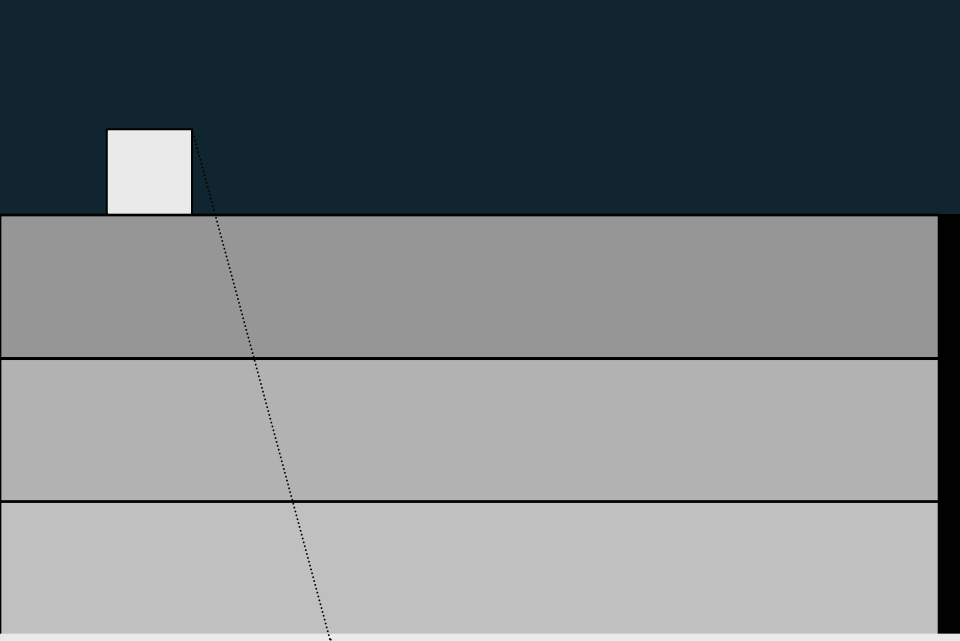

FACHADA

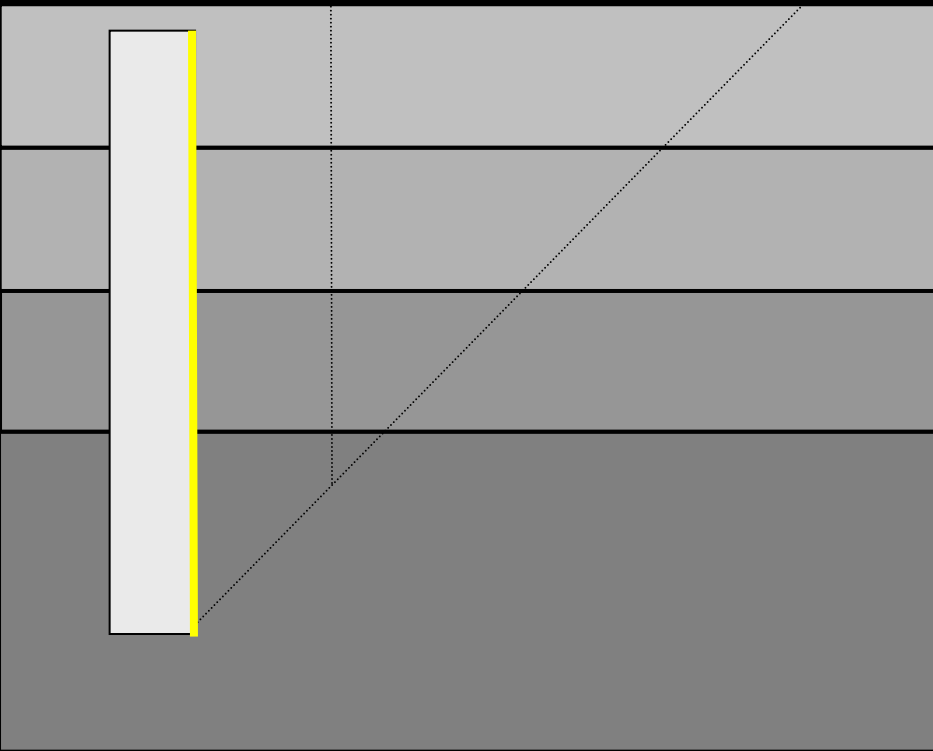

PLANTA

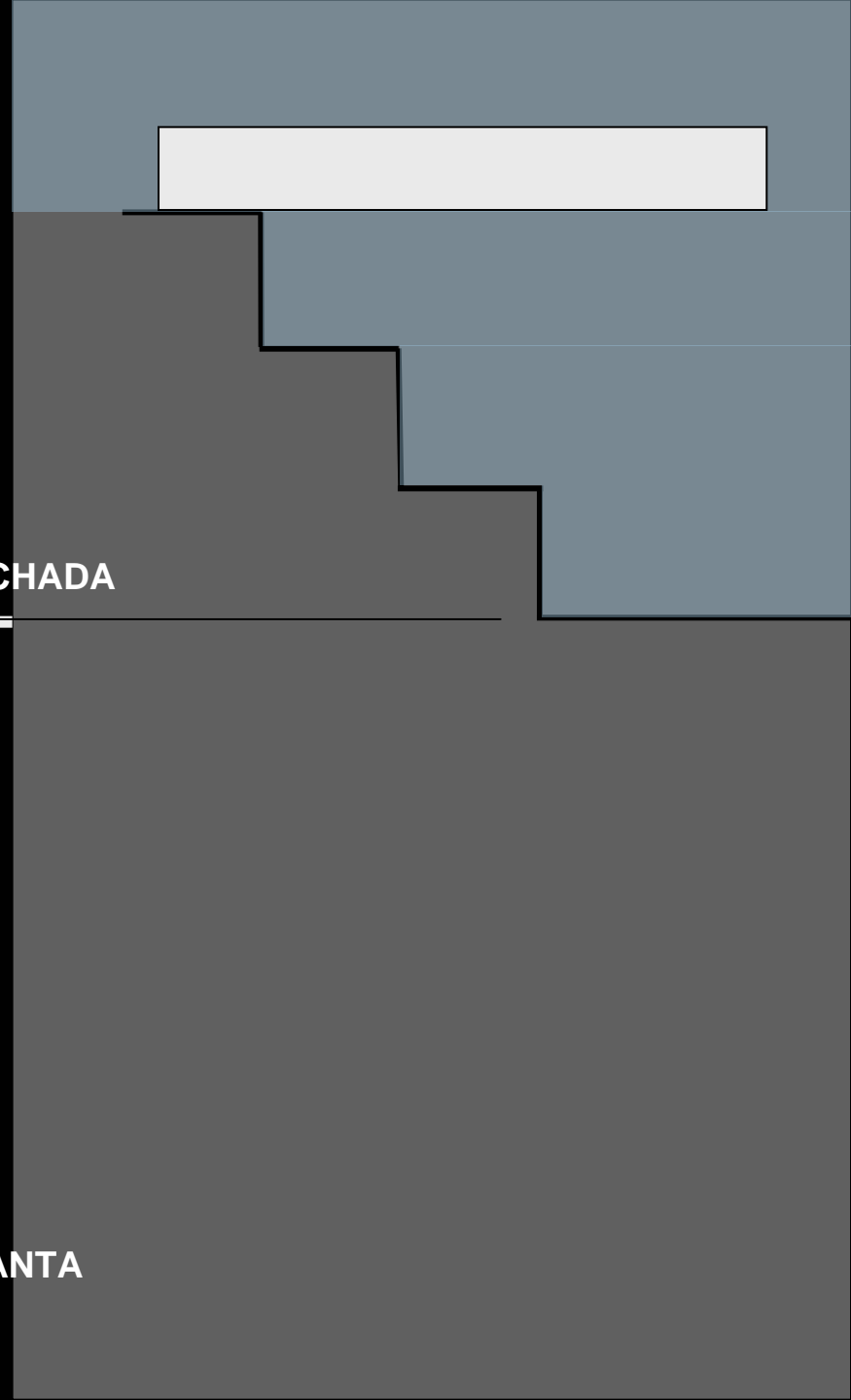

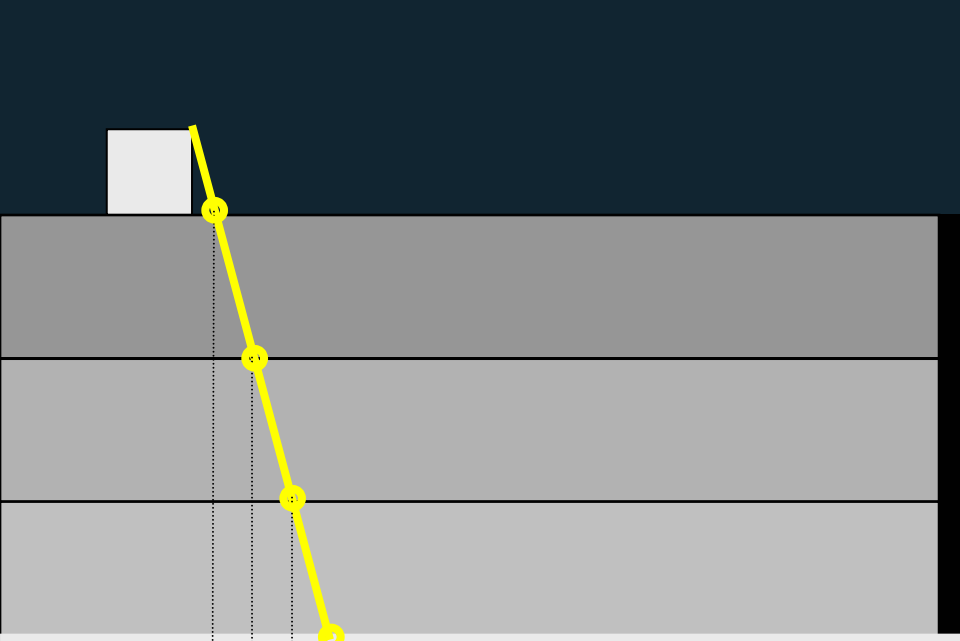

FACHADA

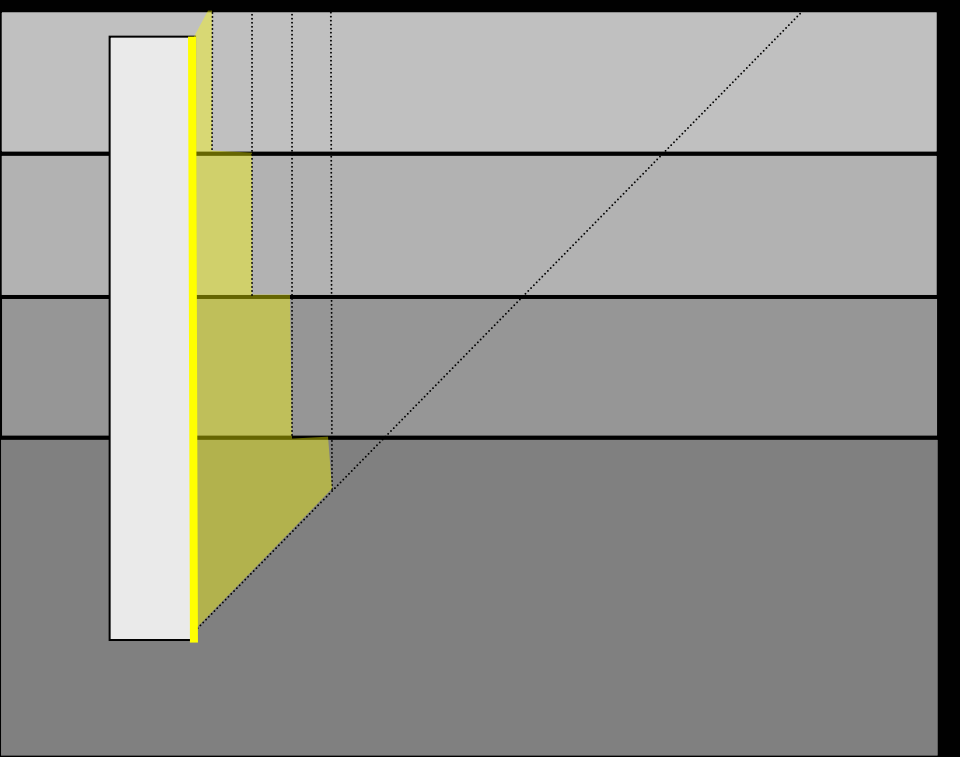

PLANTA

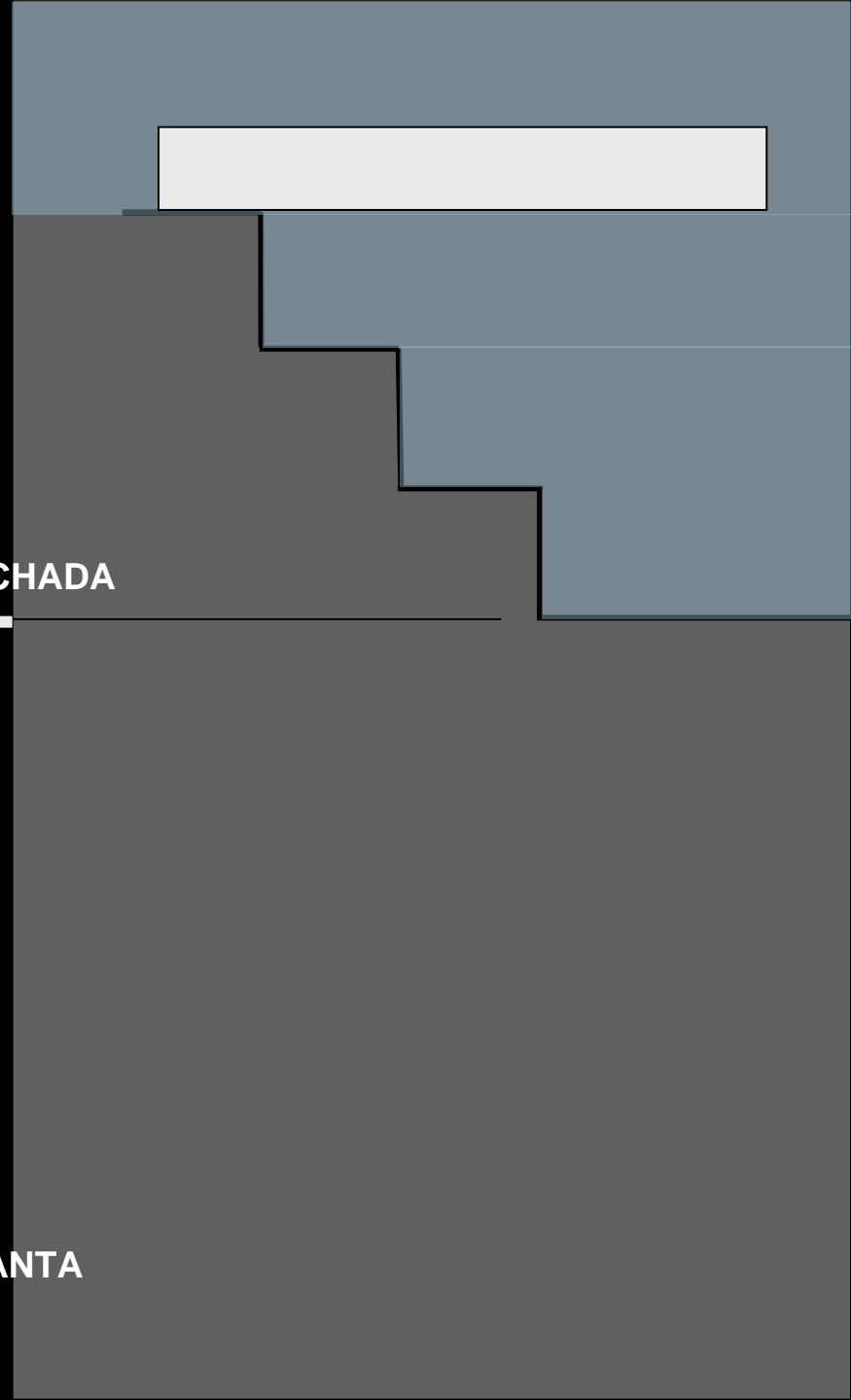

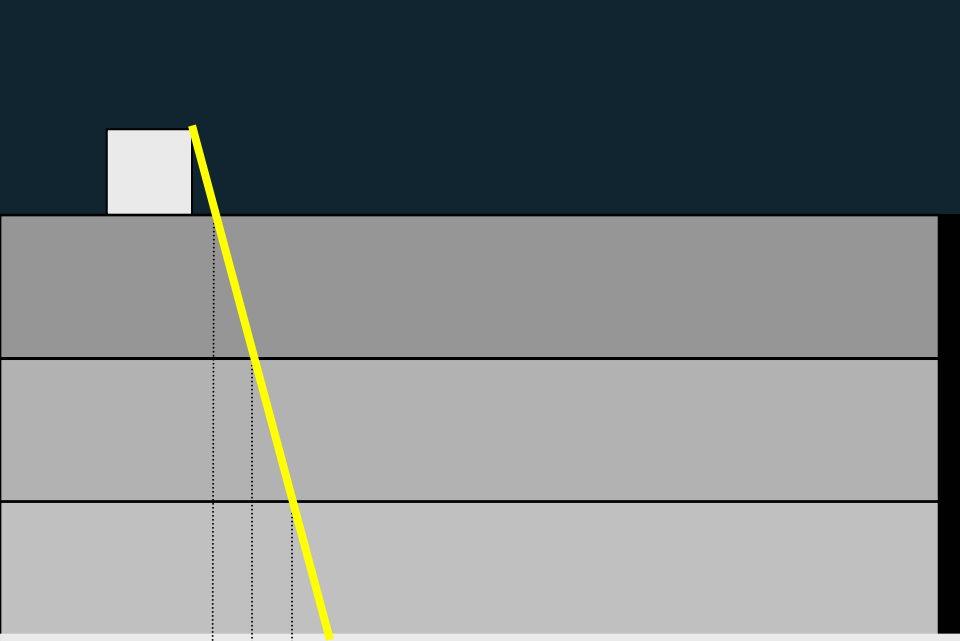

FACHADA

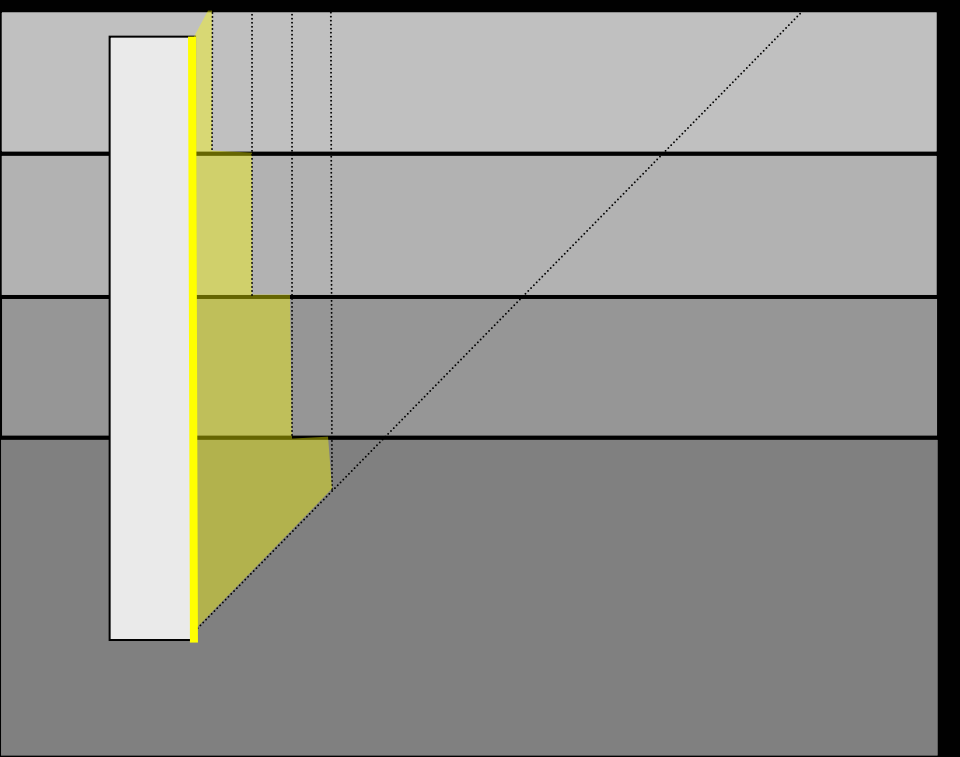

PLANTA

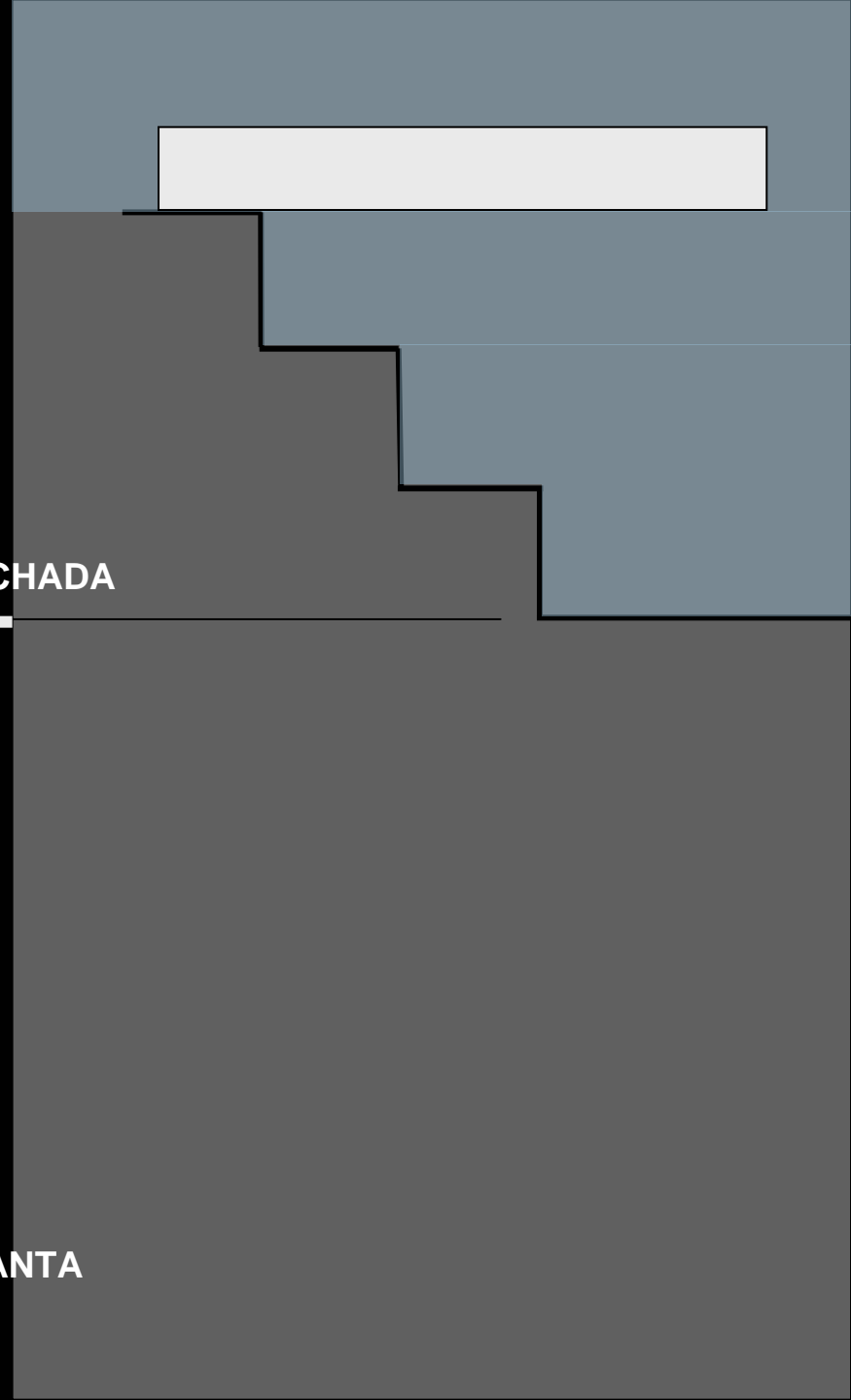

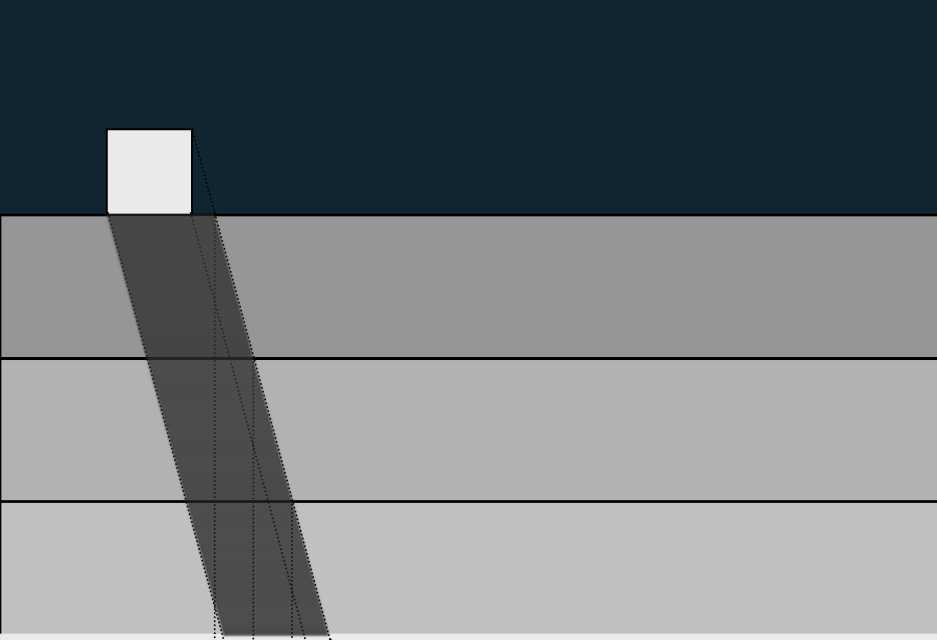

FACHADA

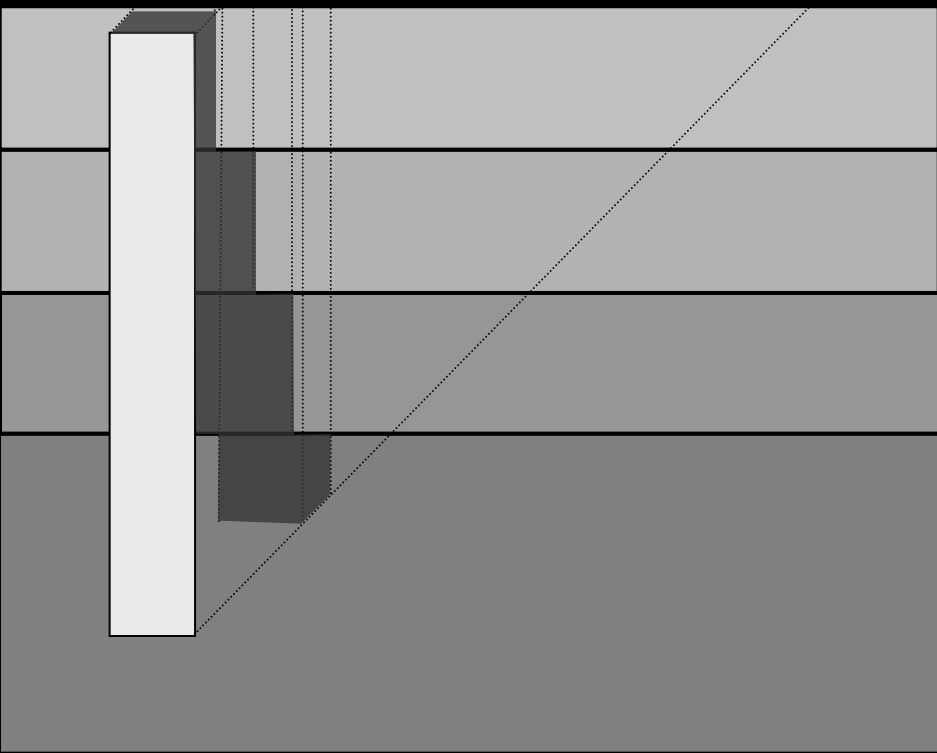

PLANTA

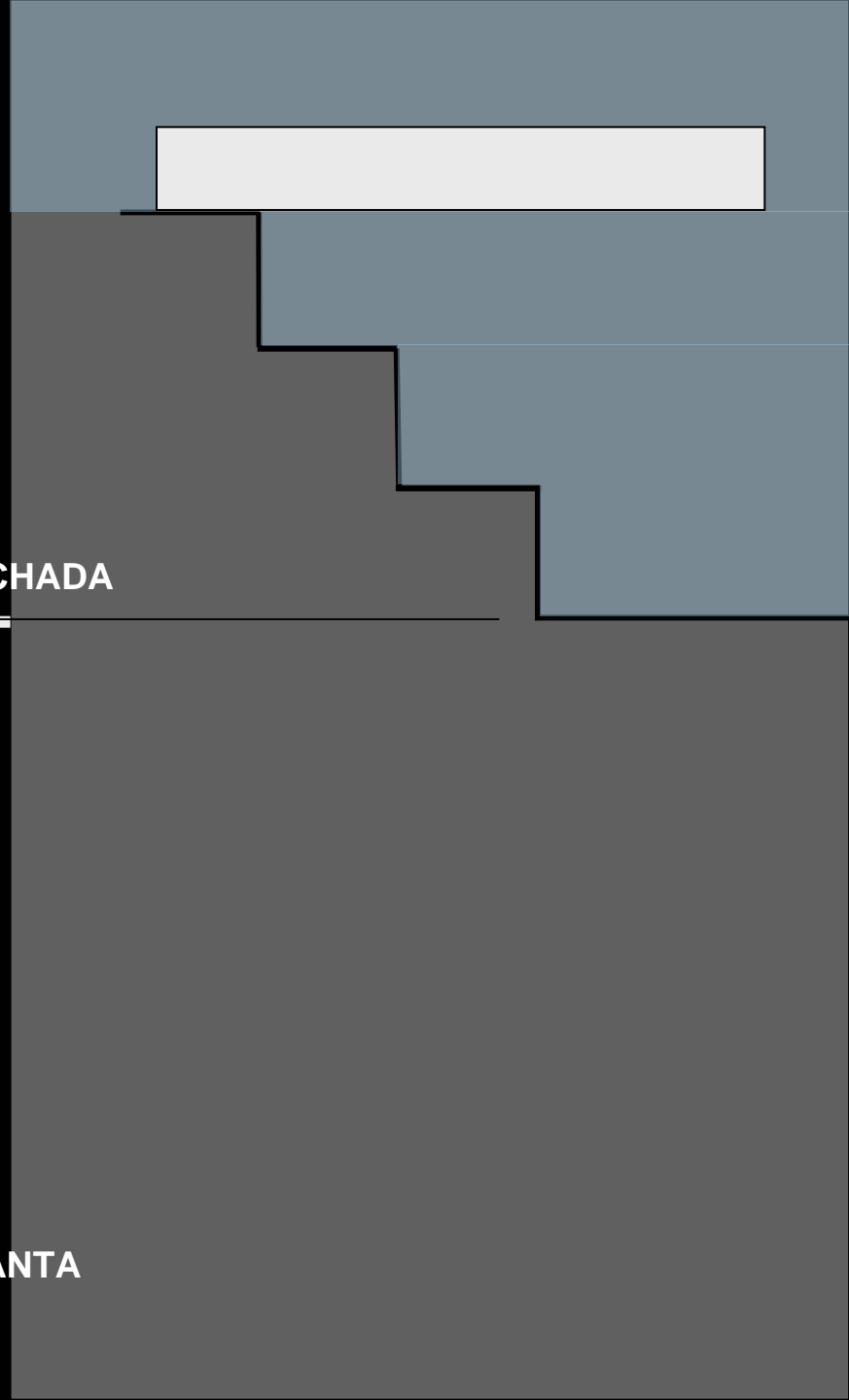

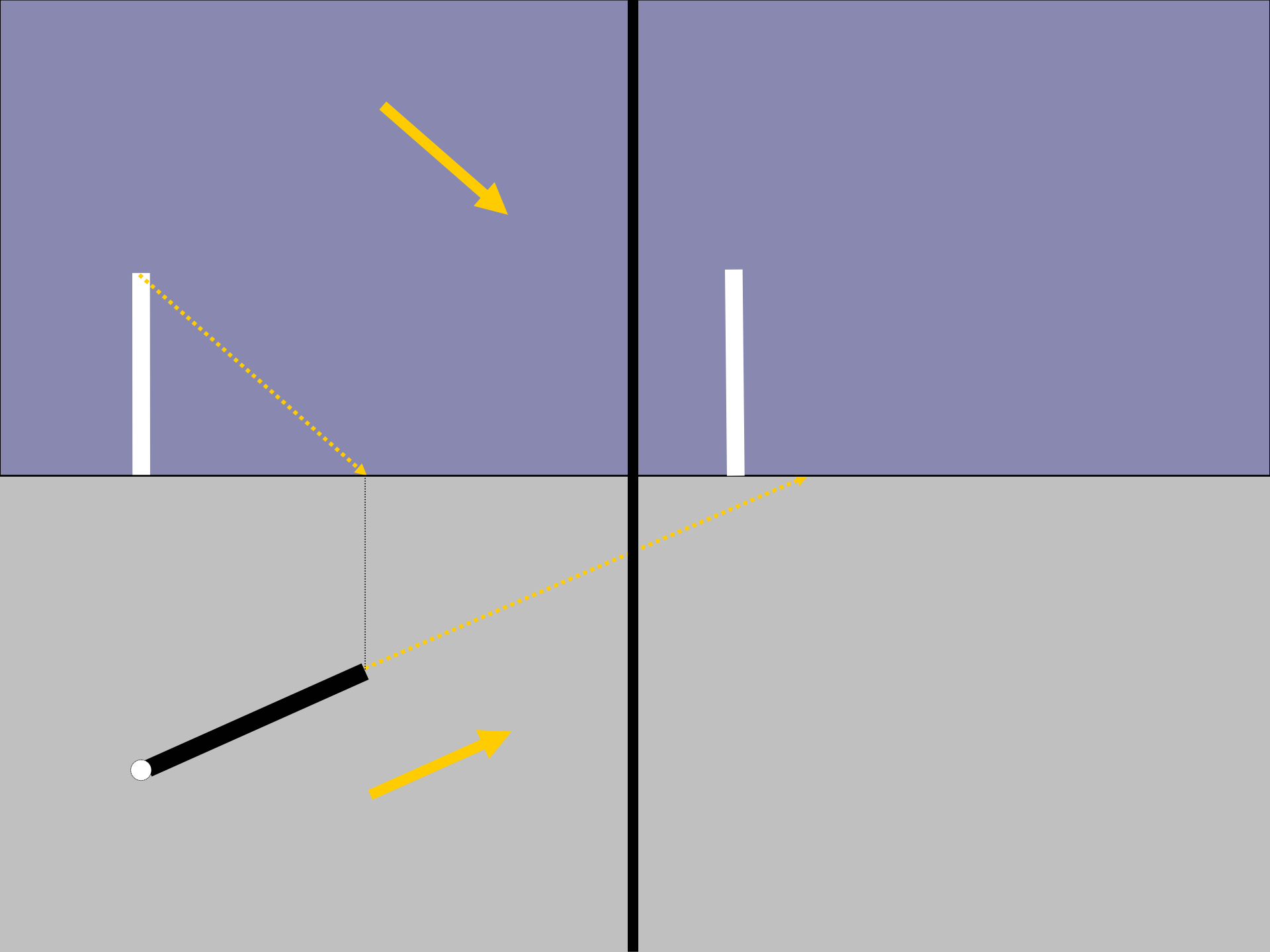

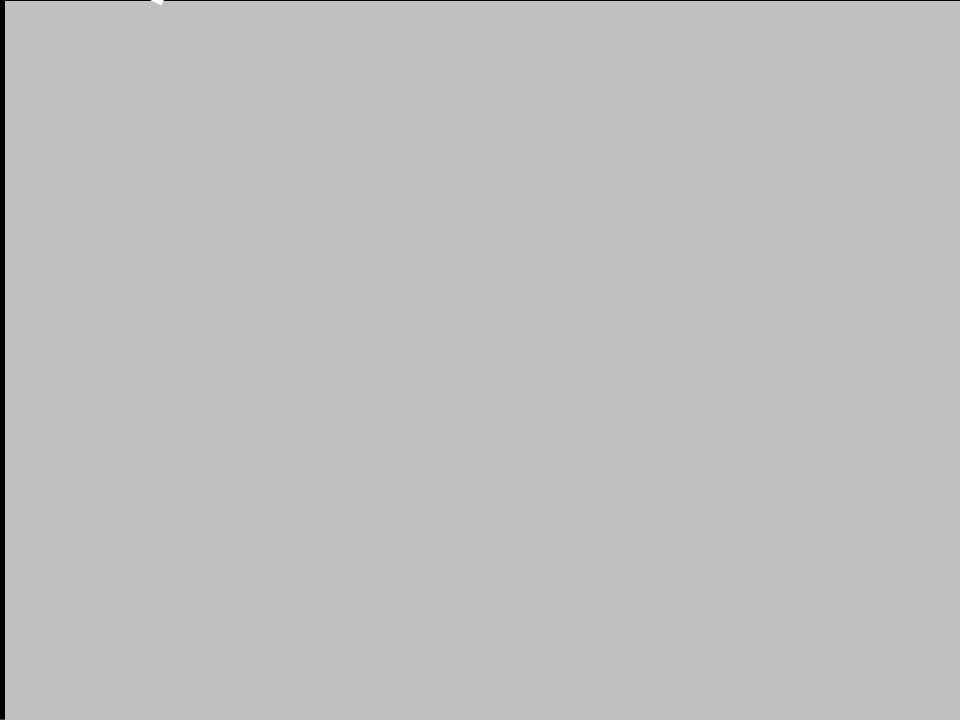
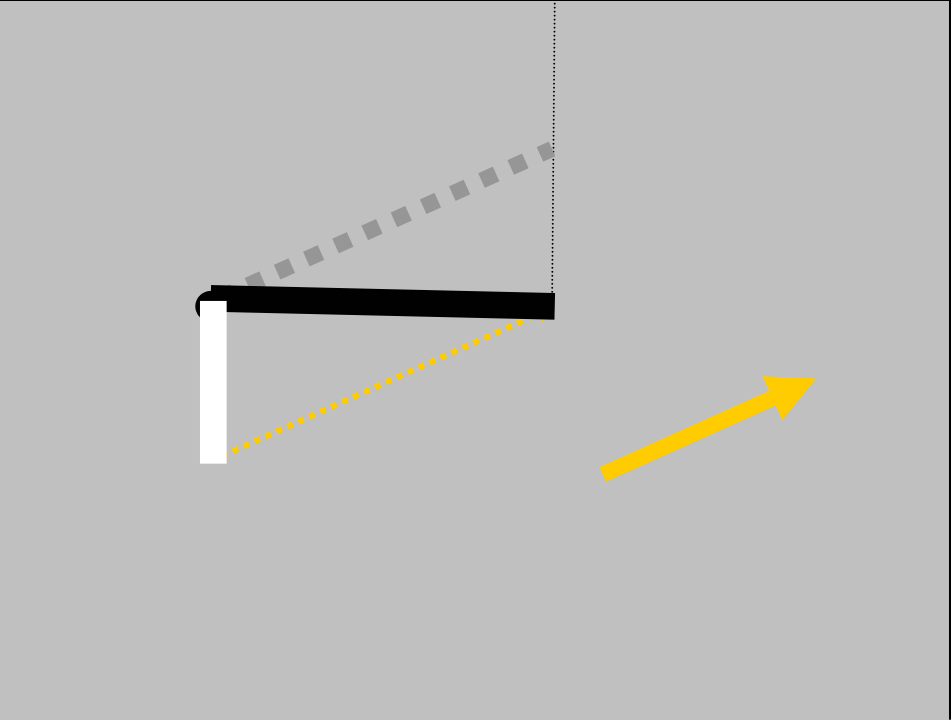
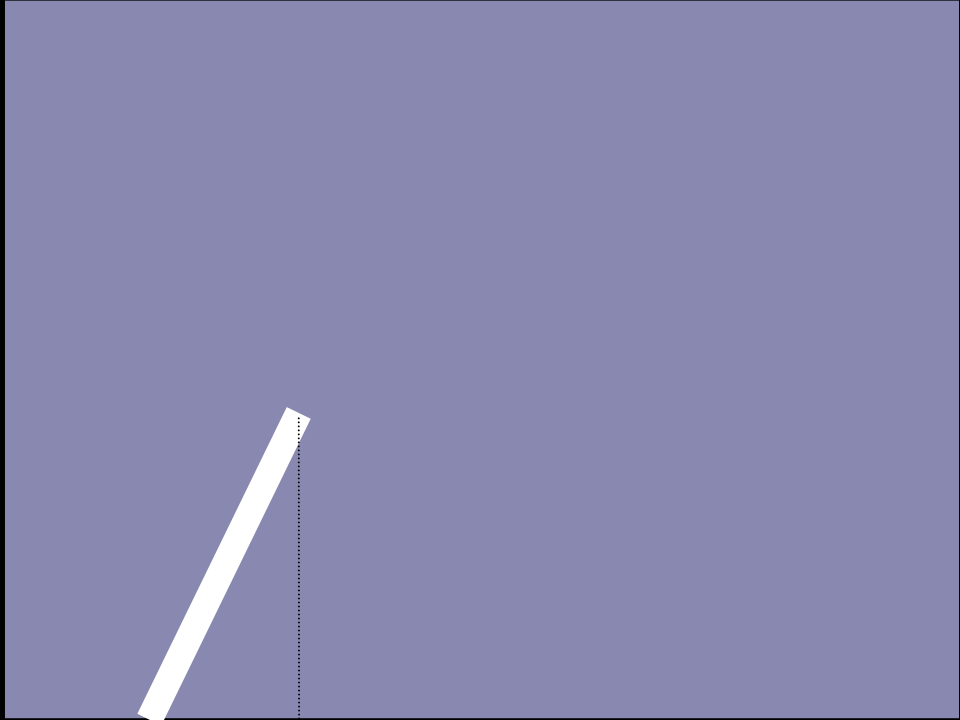
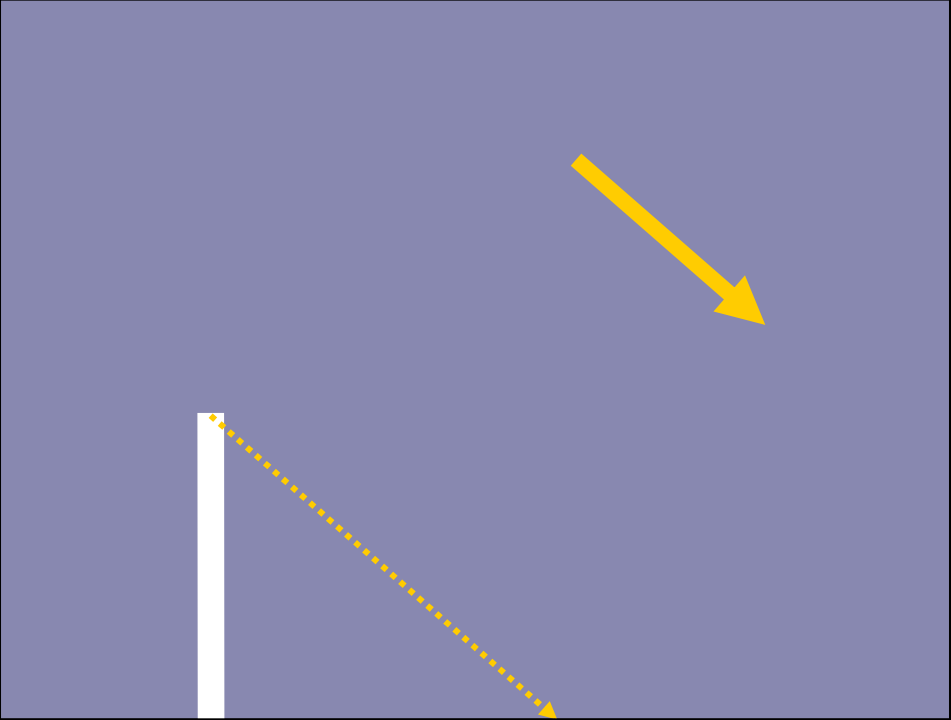

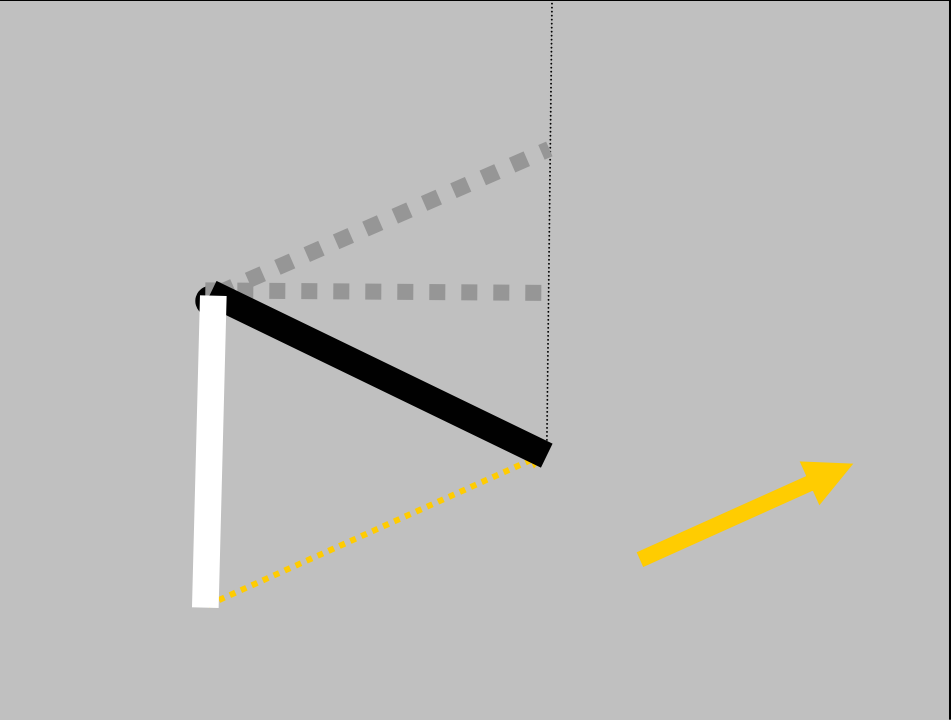
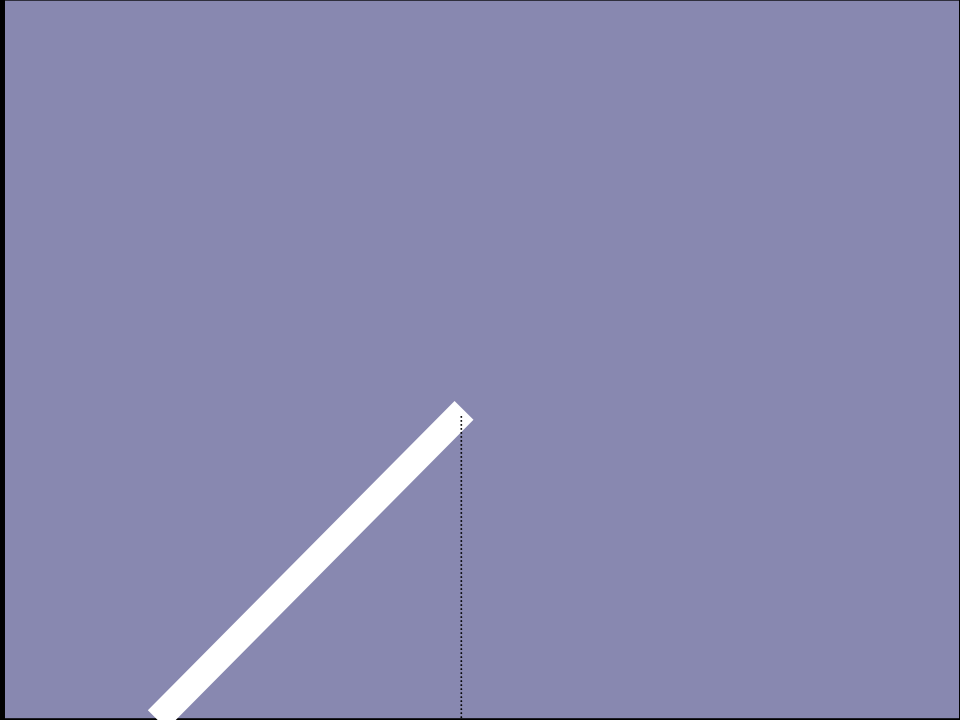
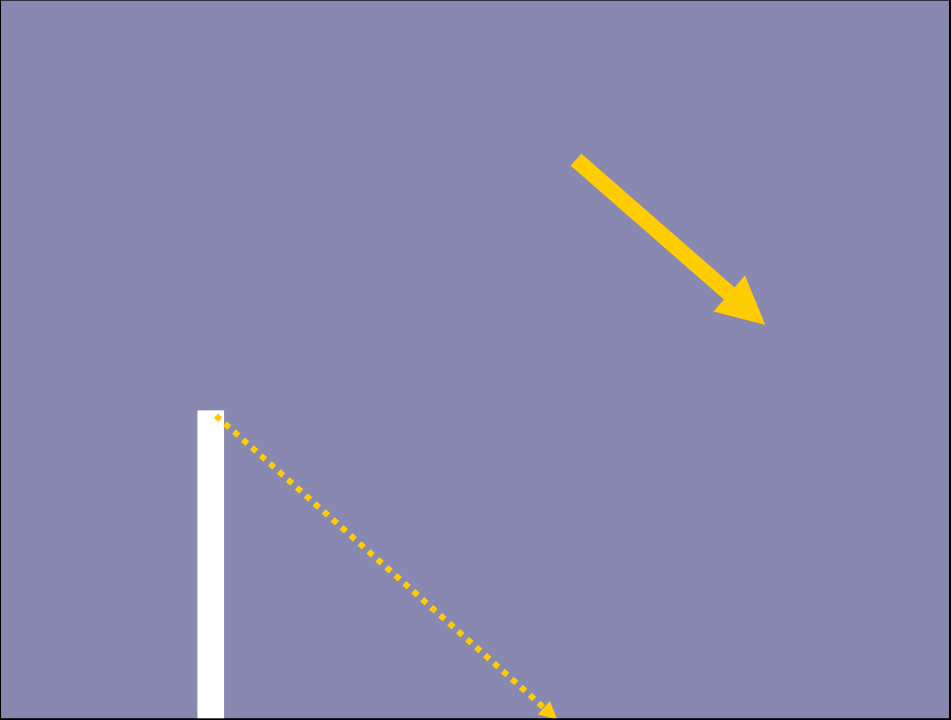

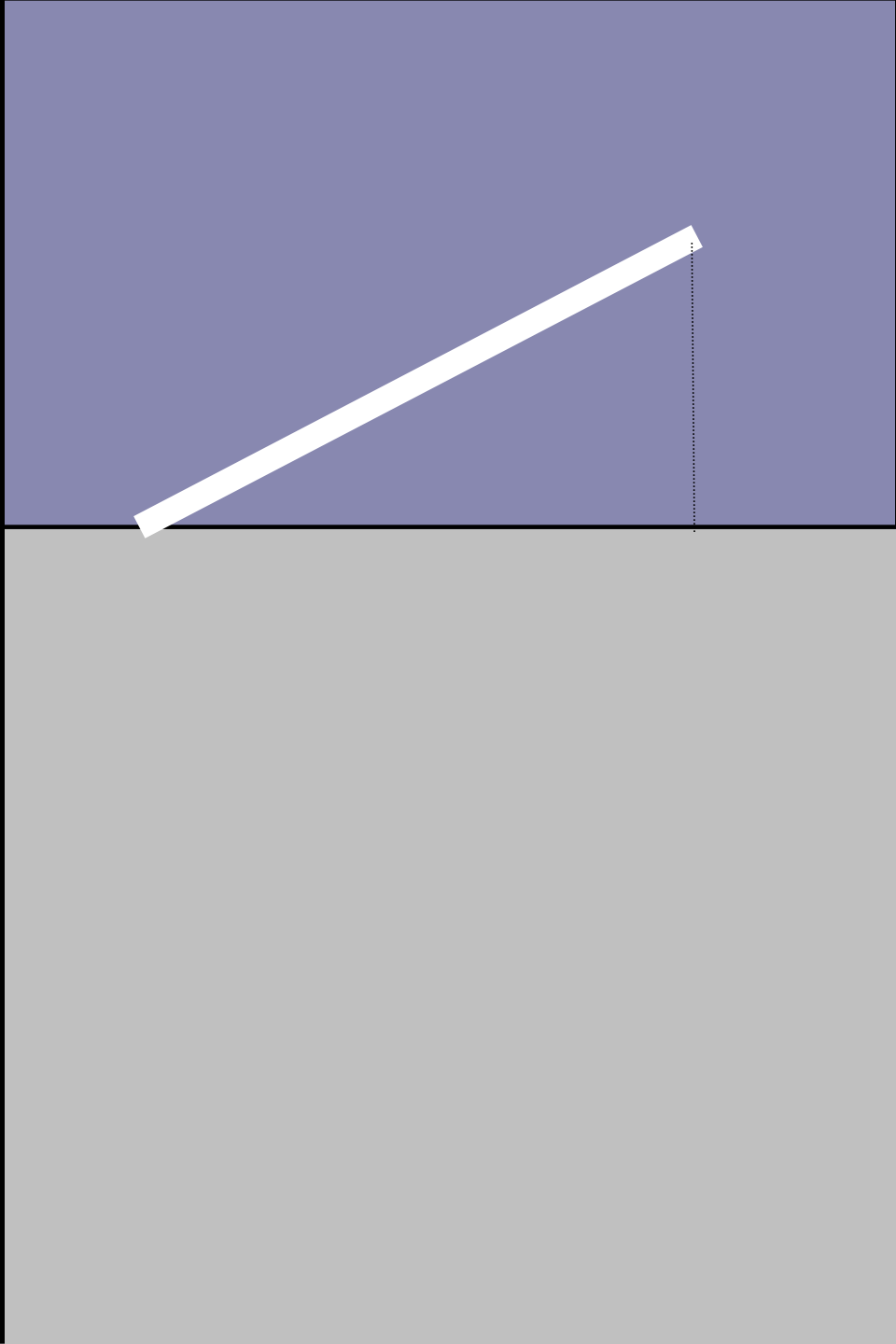
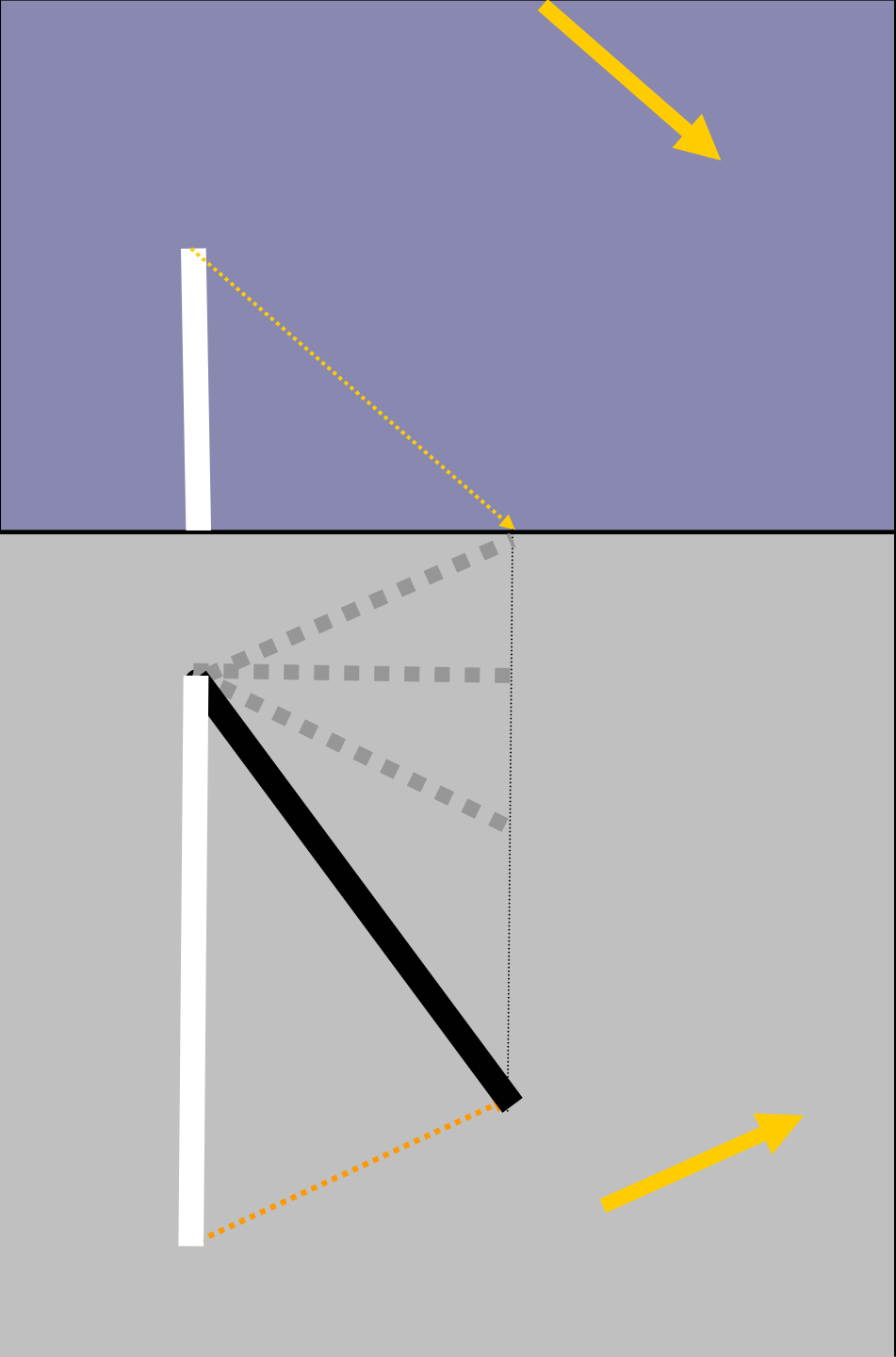

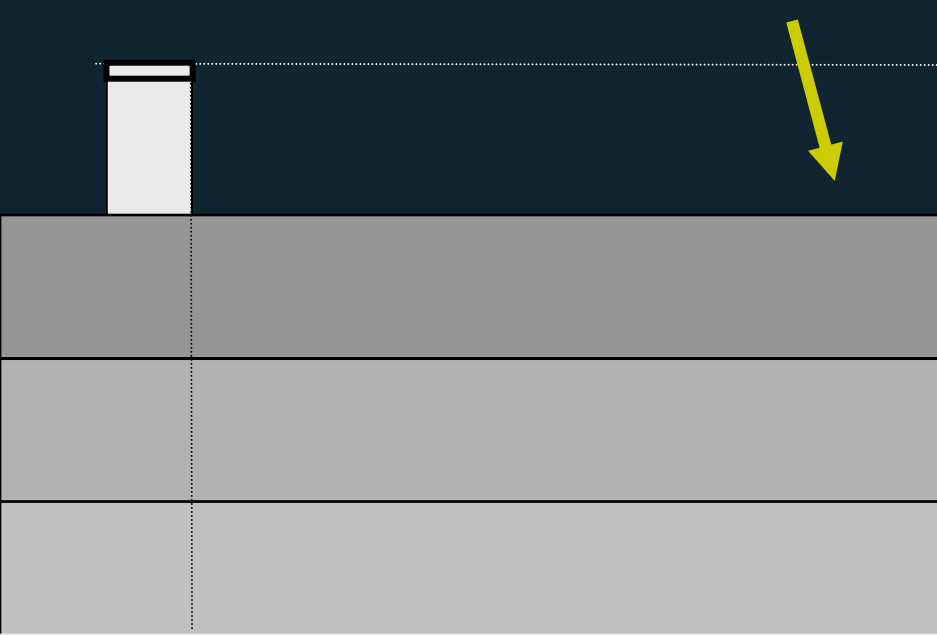

FACHADA

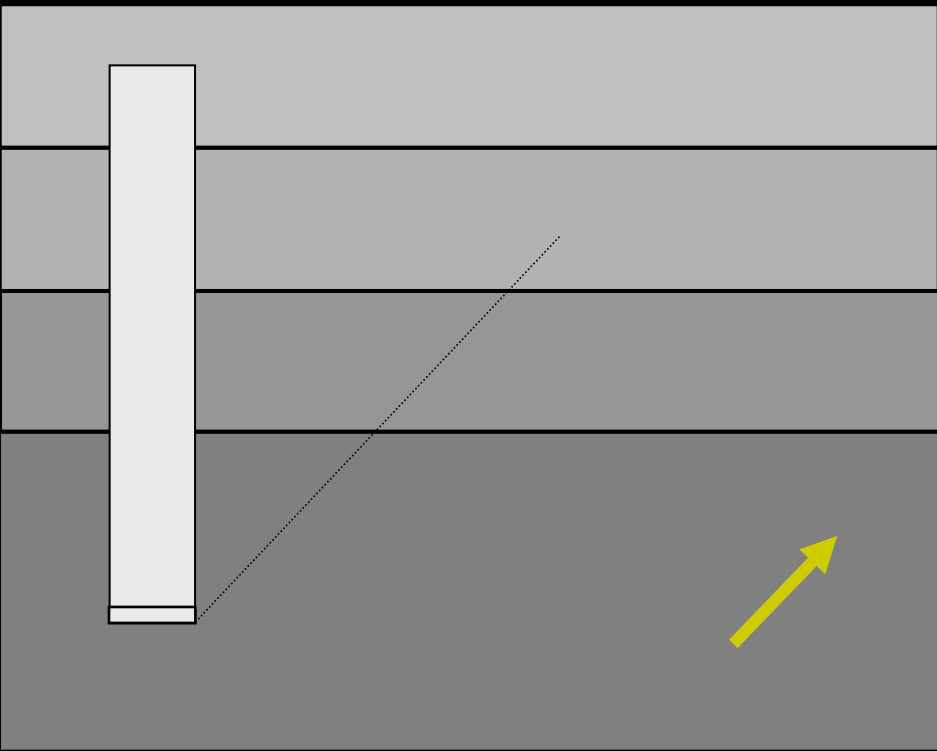

PLANTA

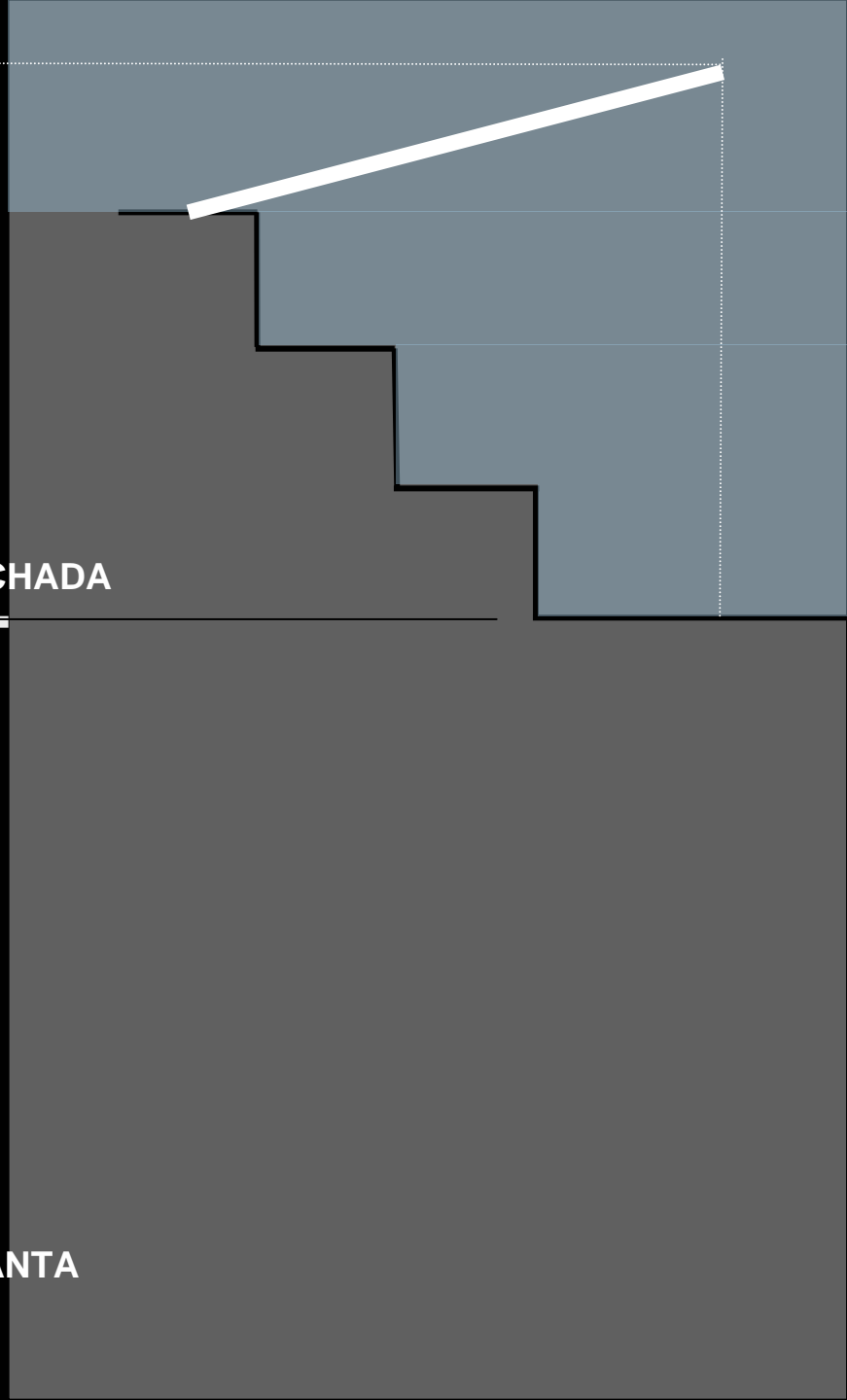

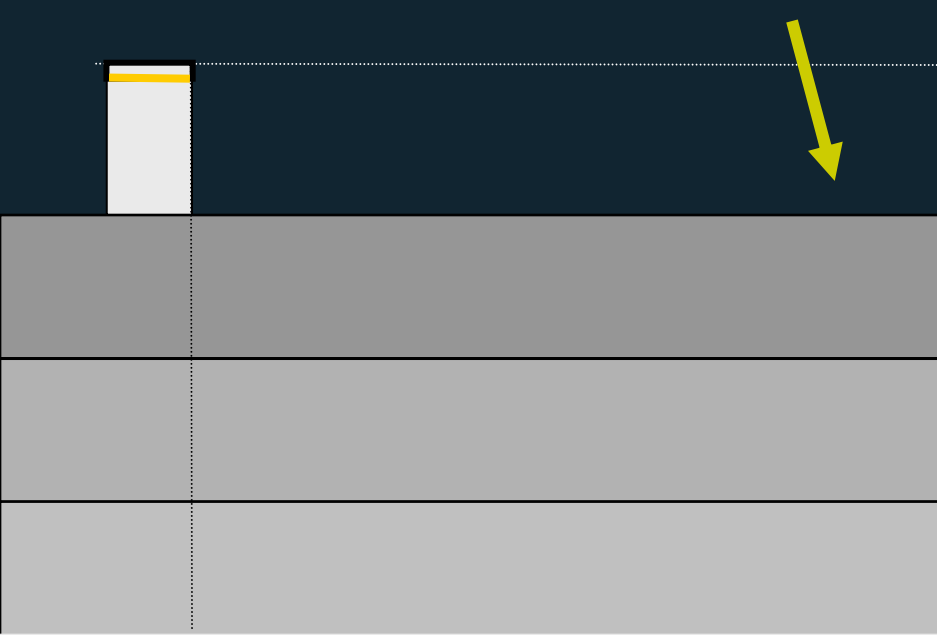

FACHADA

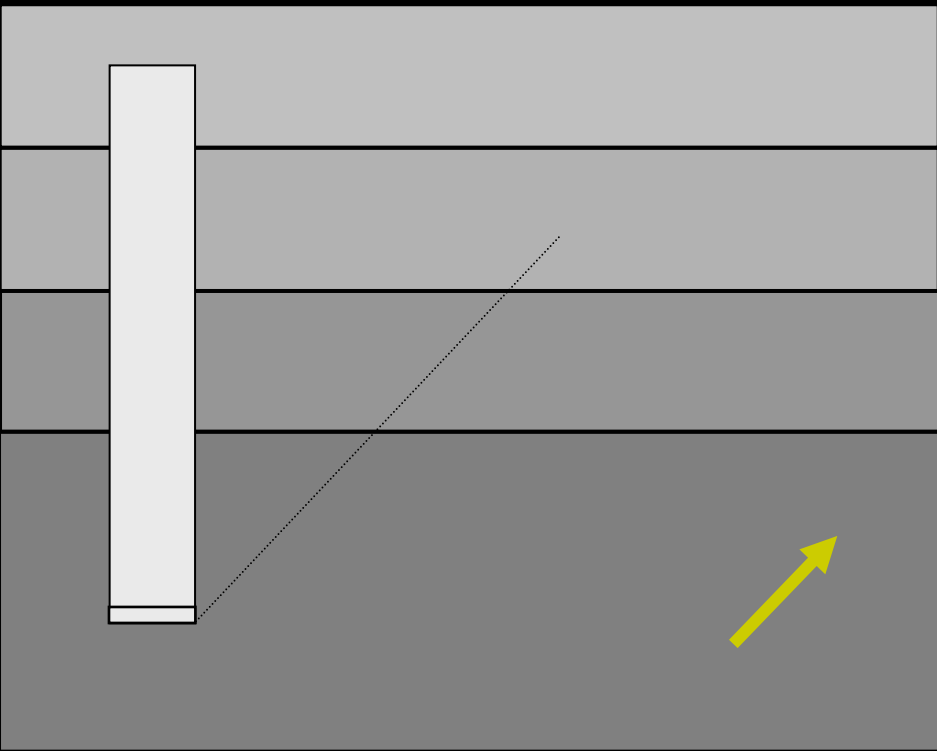

PLANTA

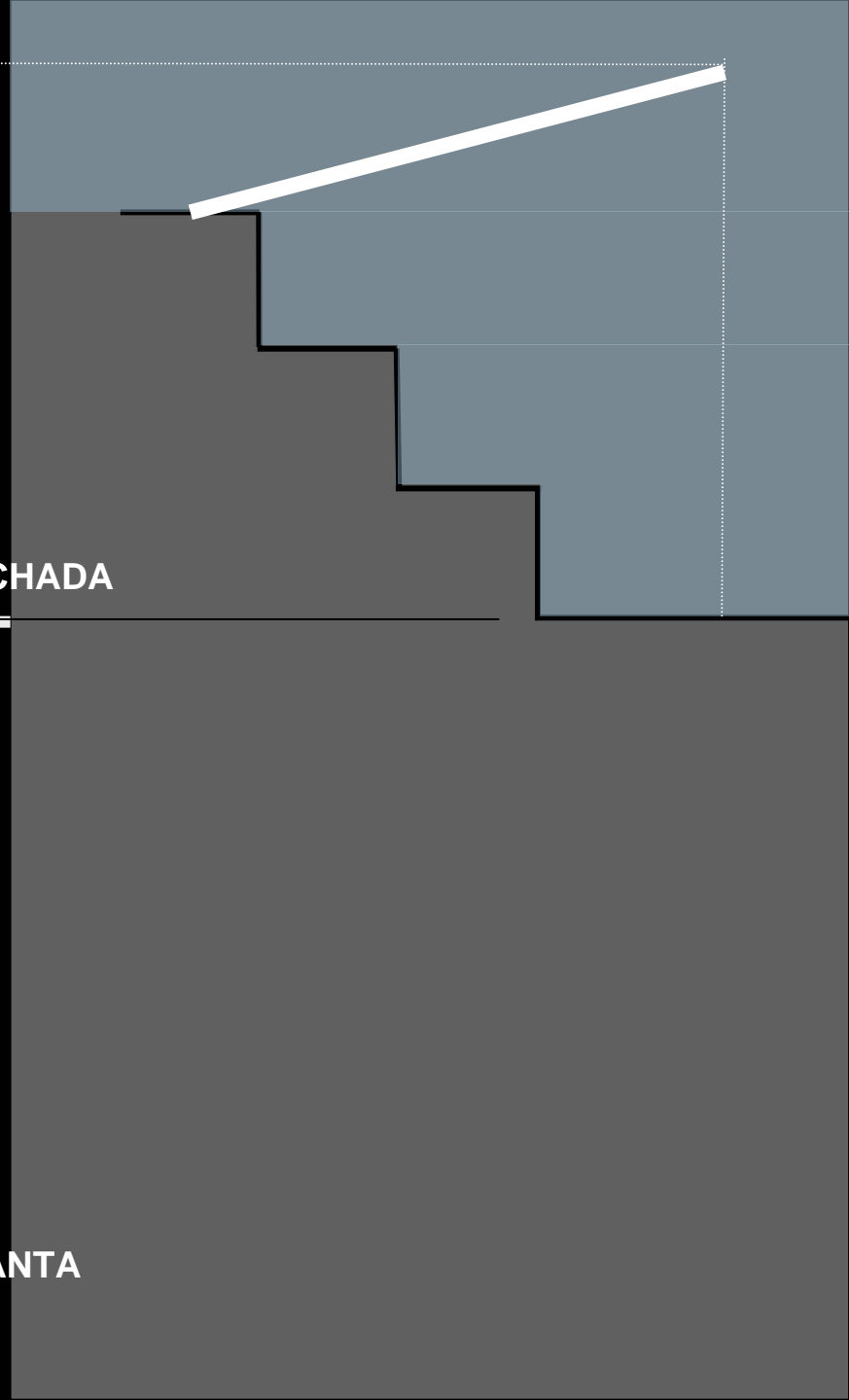

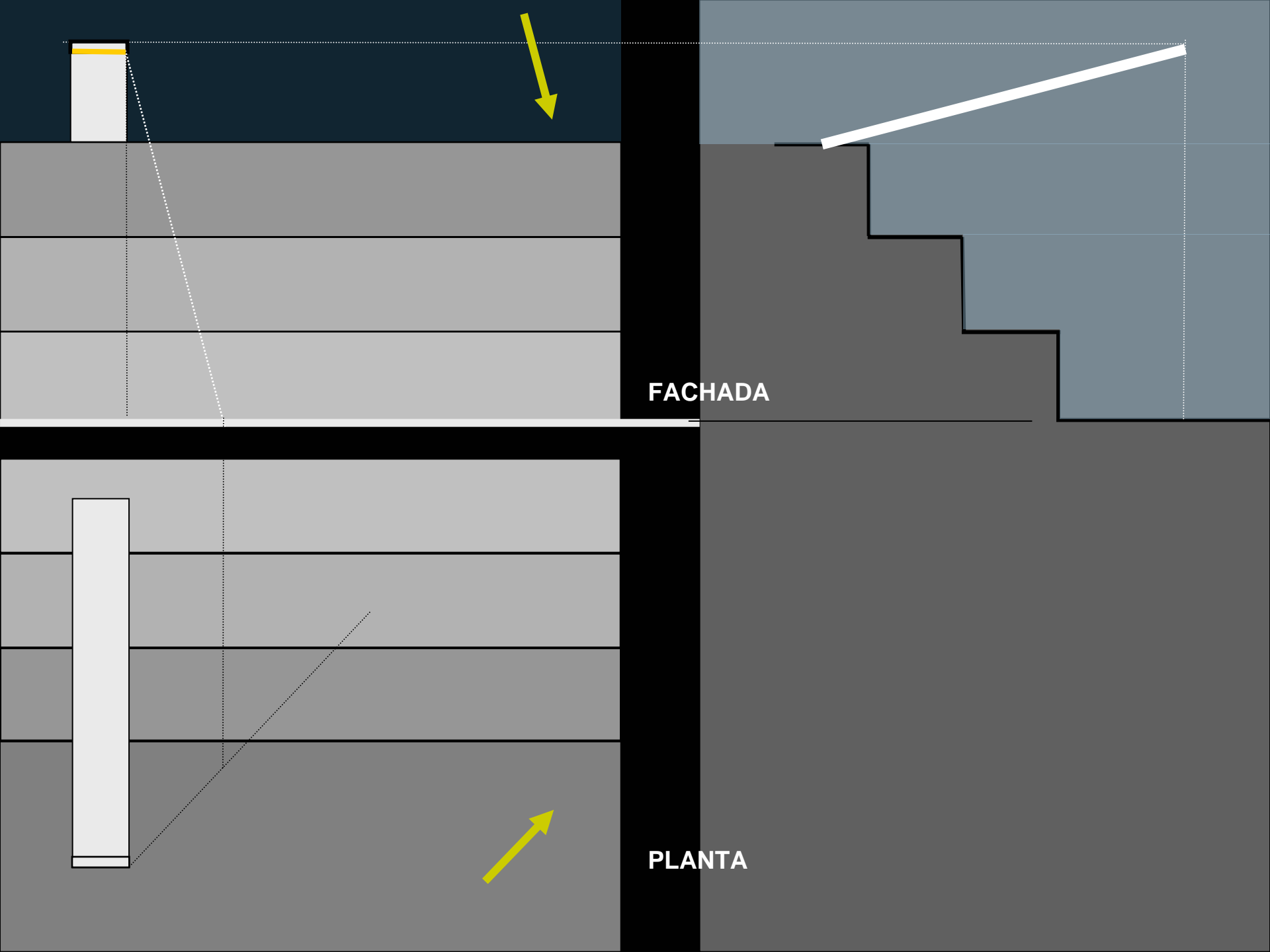

FACHADA

PLANTA

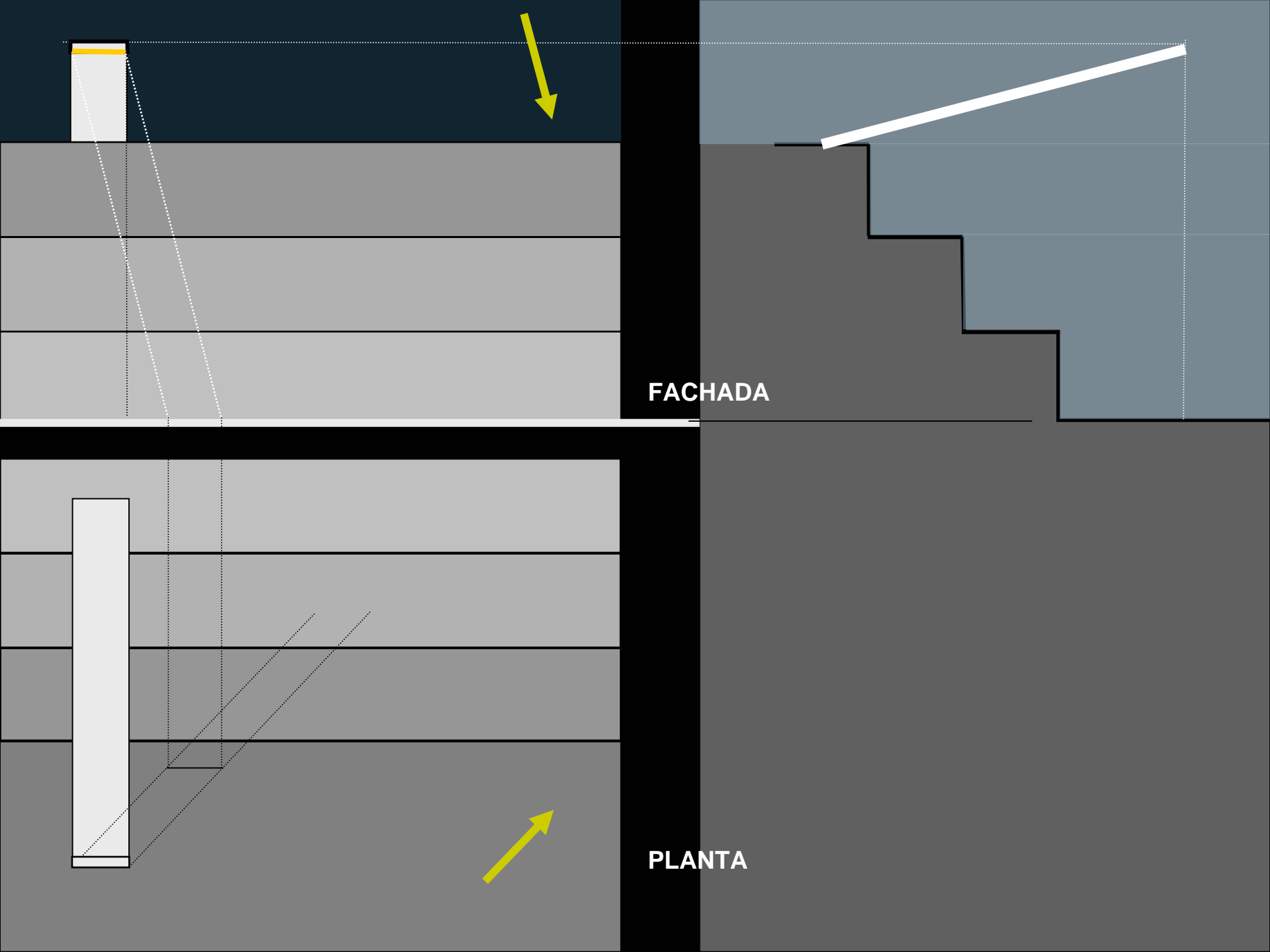

FACHADA

PLANTA

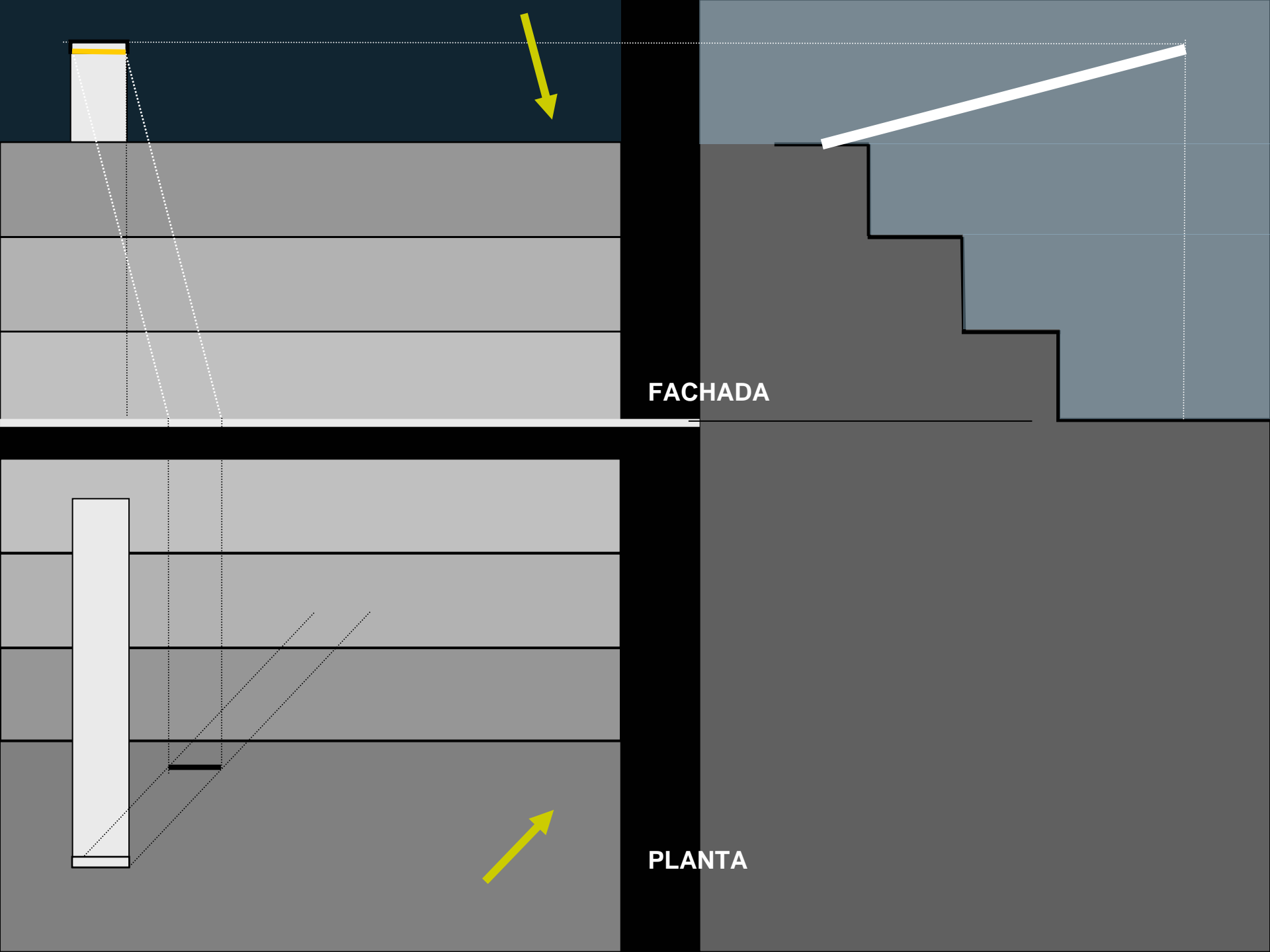

FACHADA

PLANTA

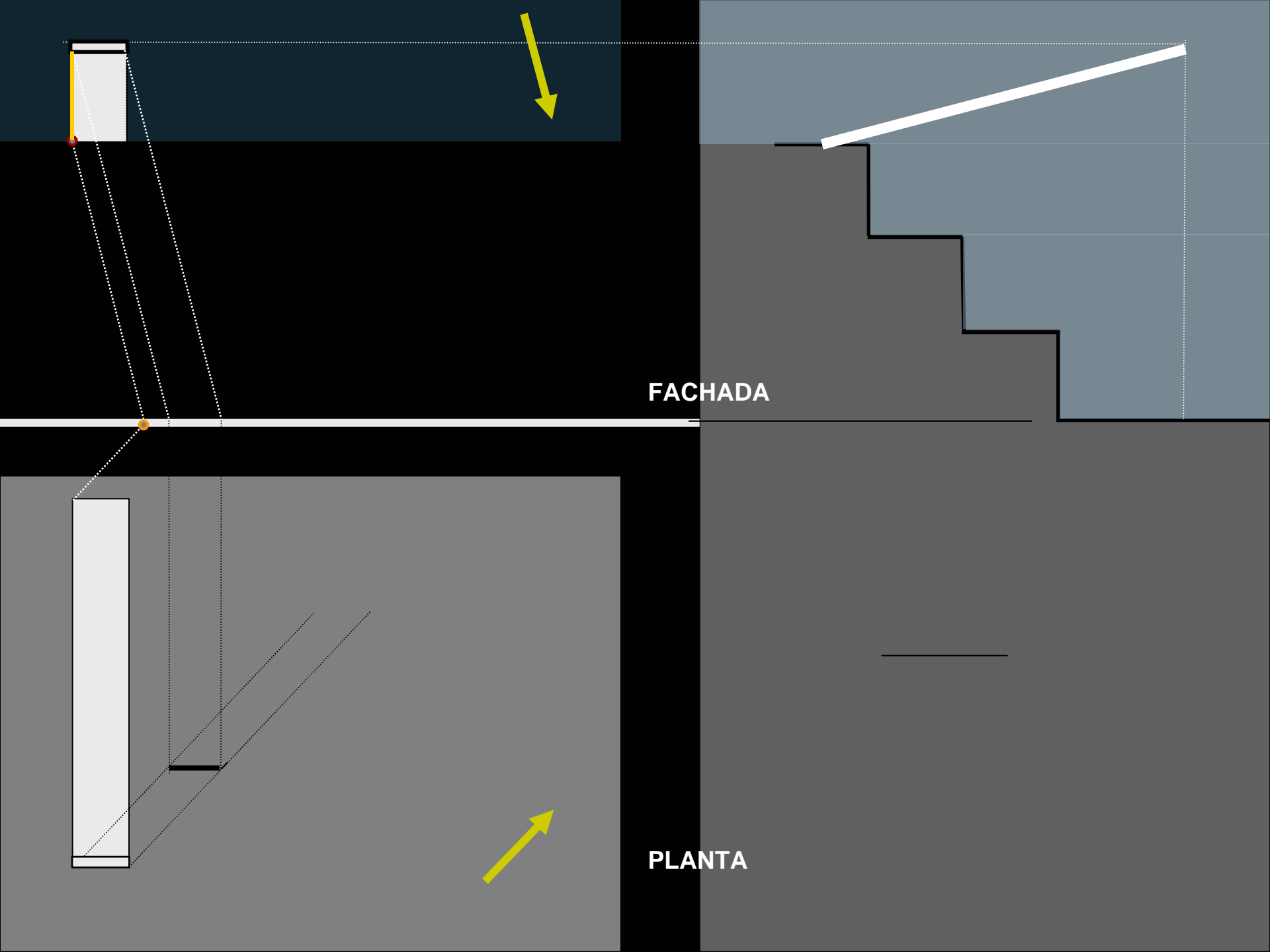

FACHADA

PLANTA

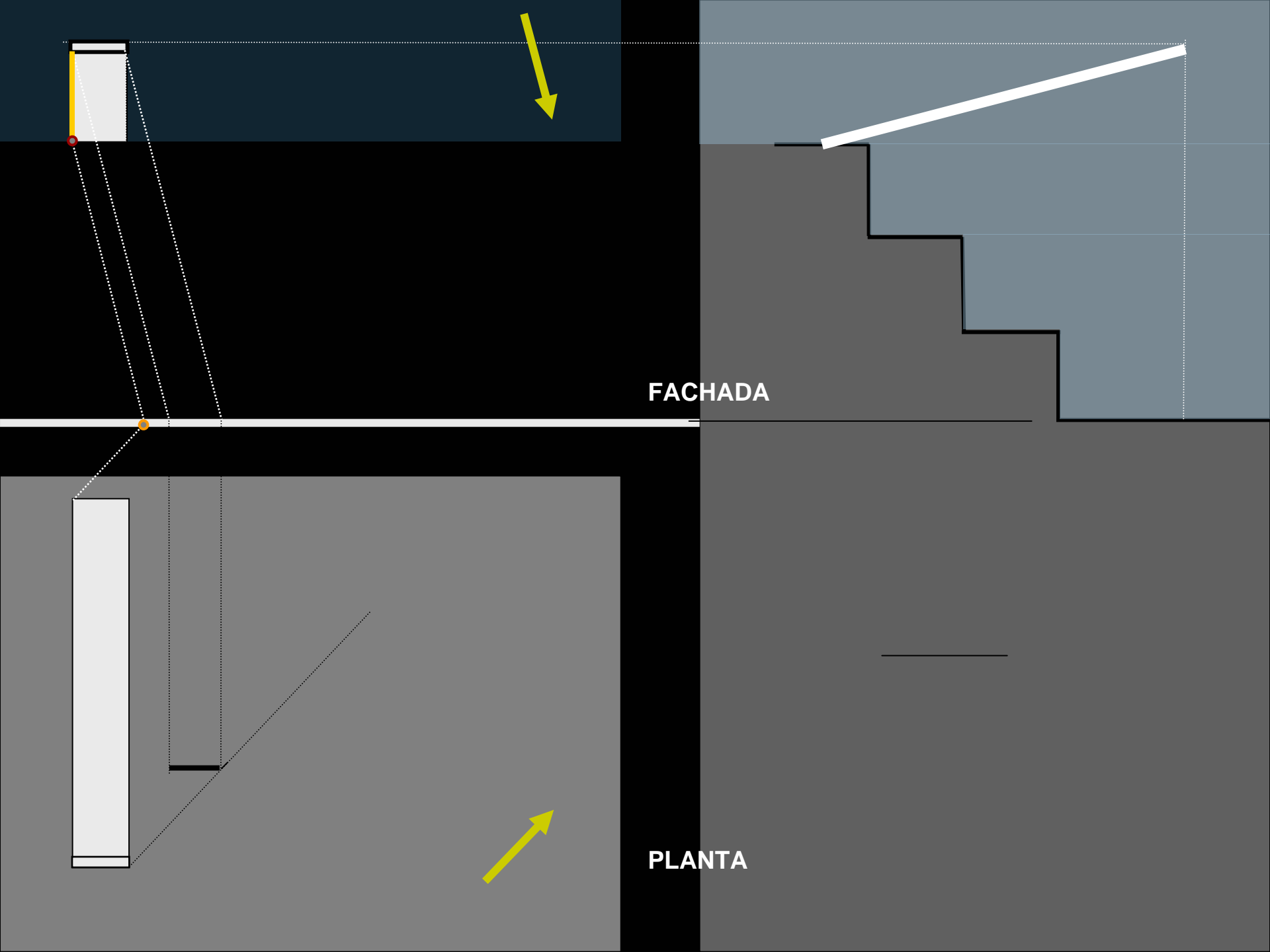

FACHADA

PLANTA

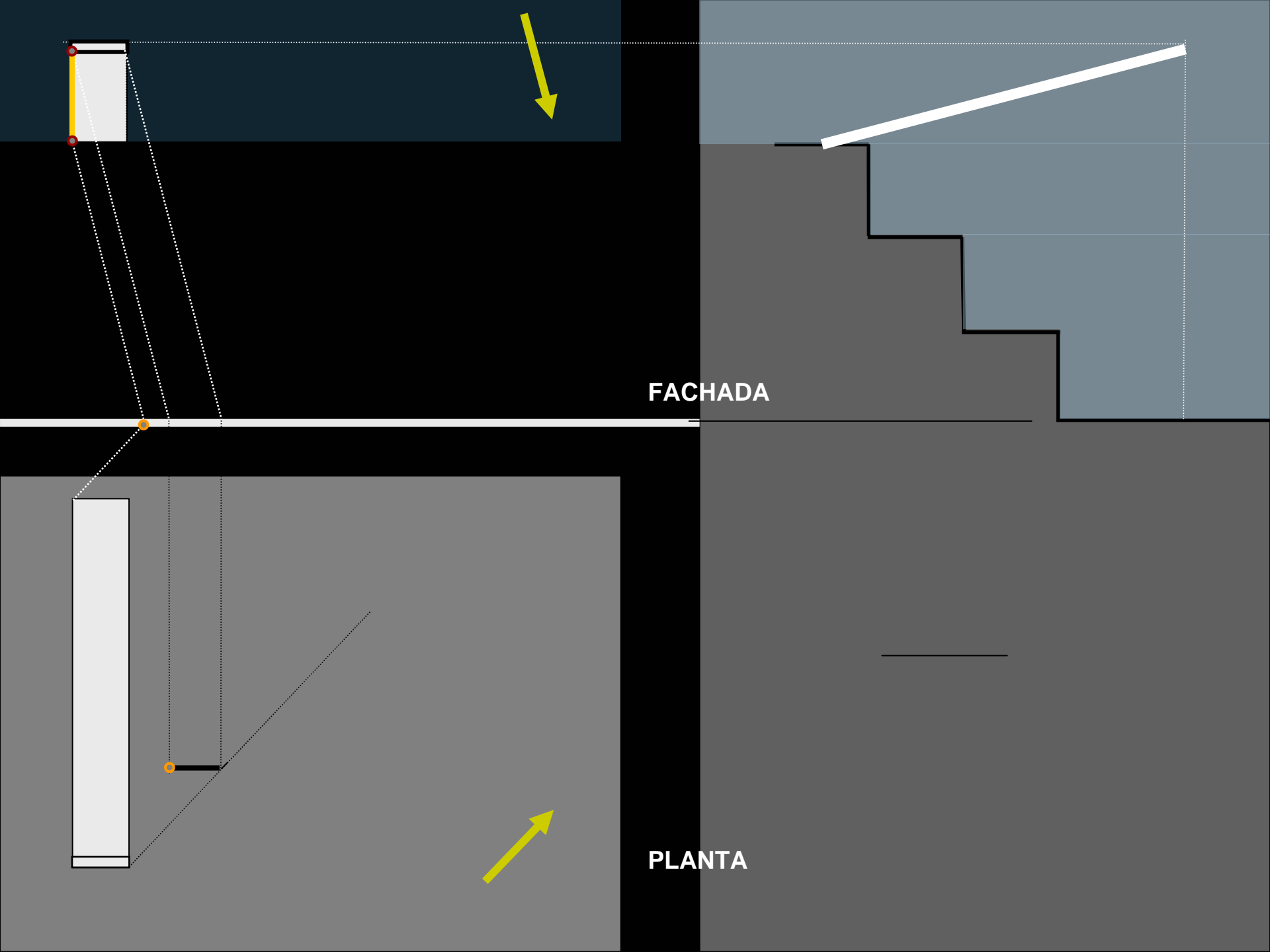

FACHADA

PLANTA

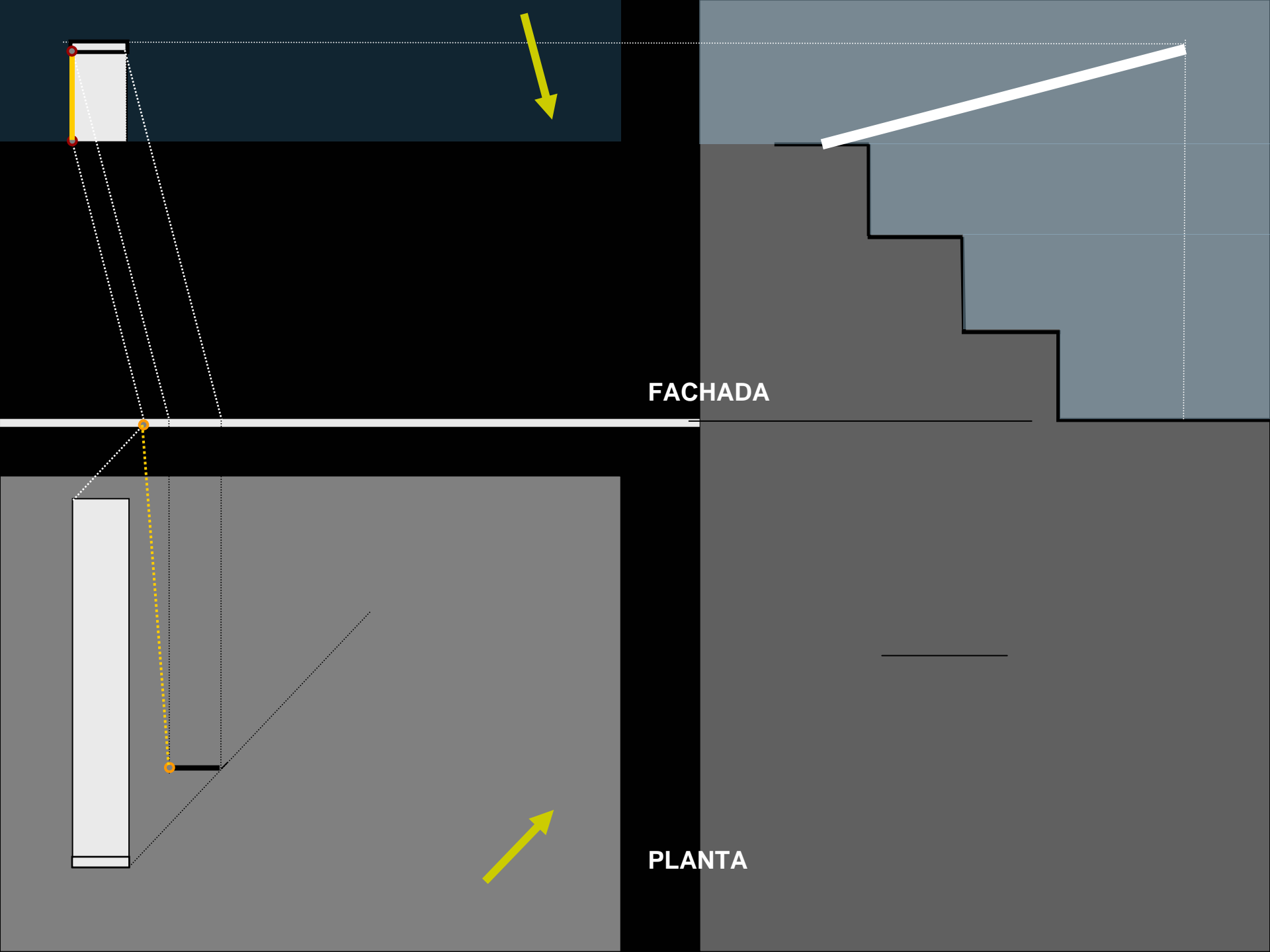

FACHADA

PLANTA

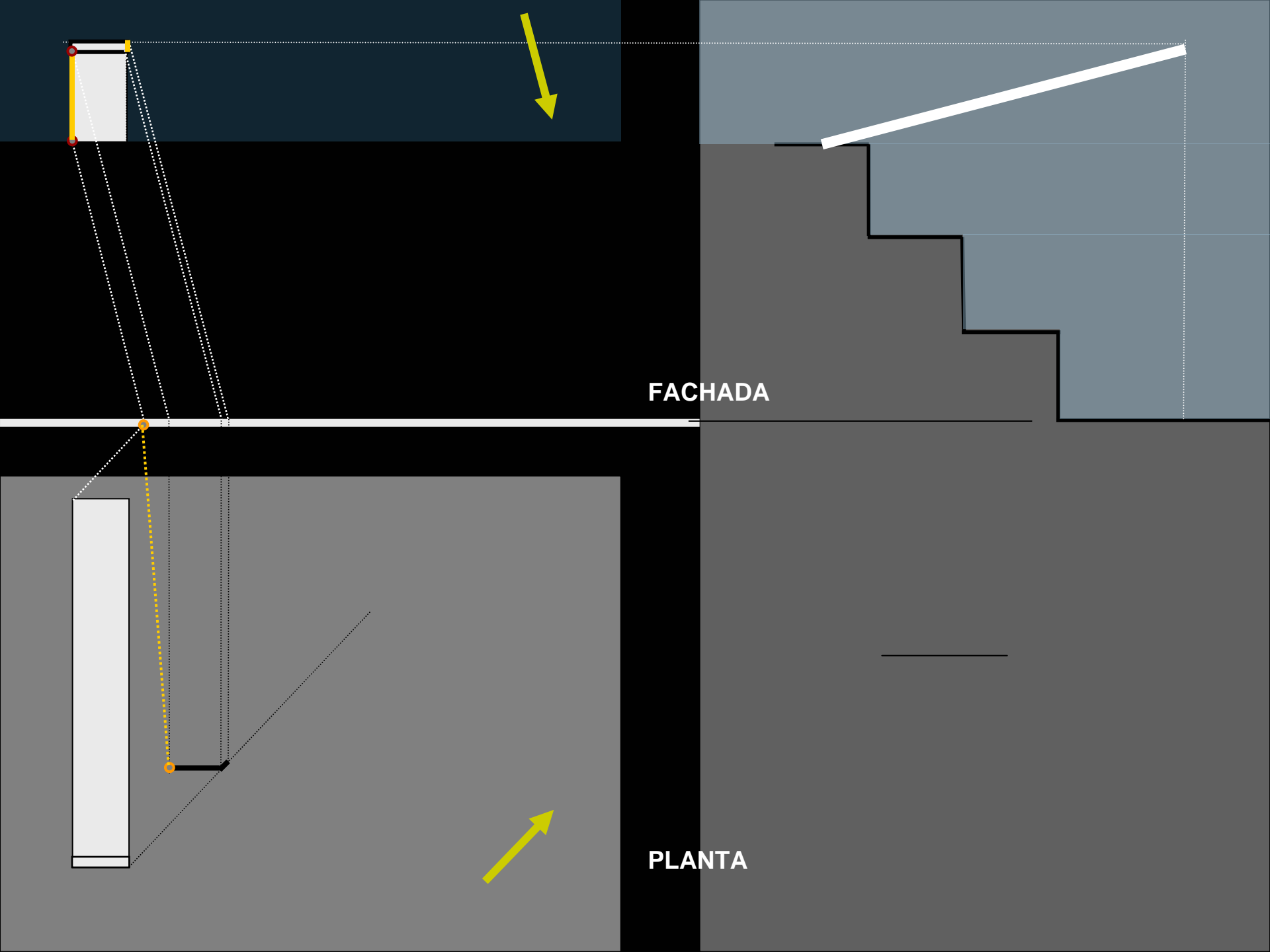

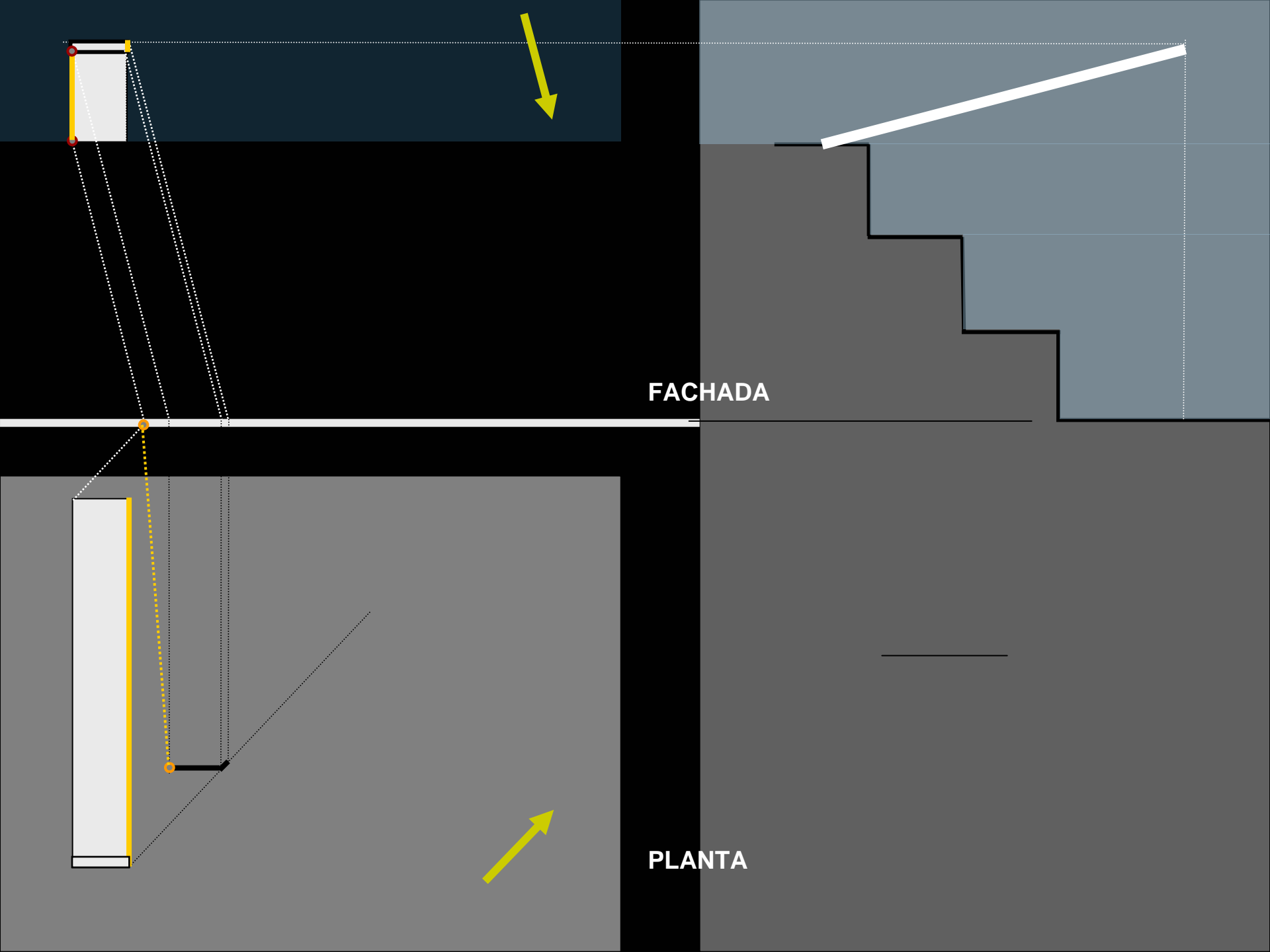

FACHADA

PLANTA

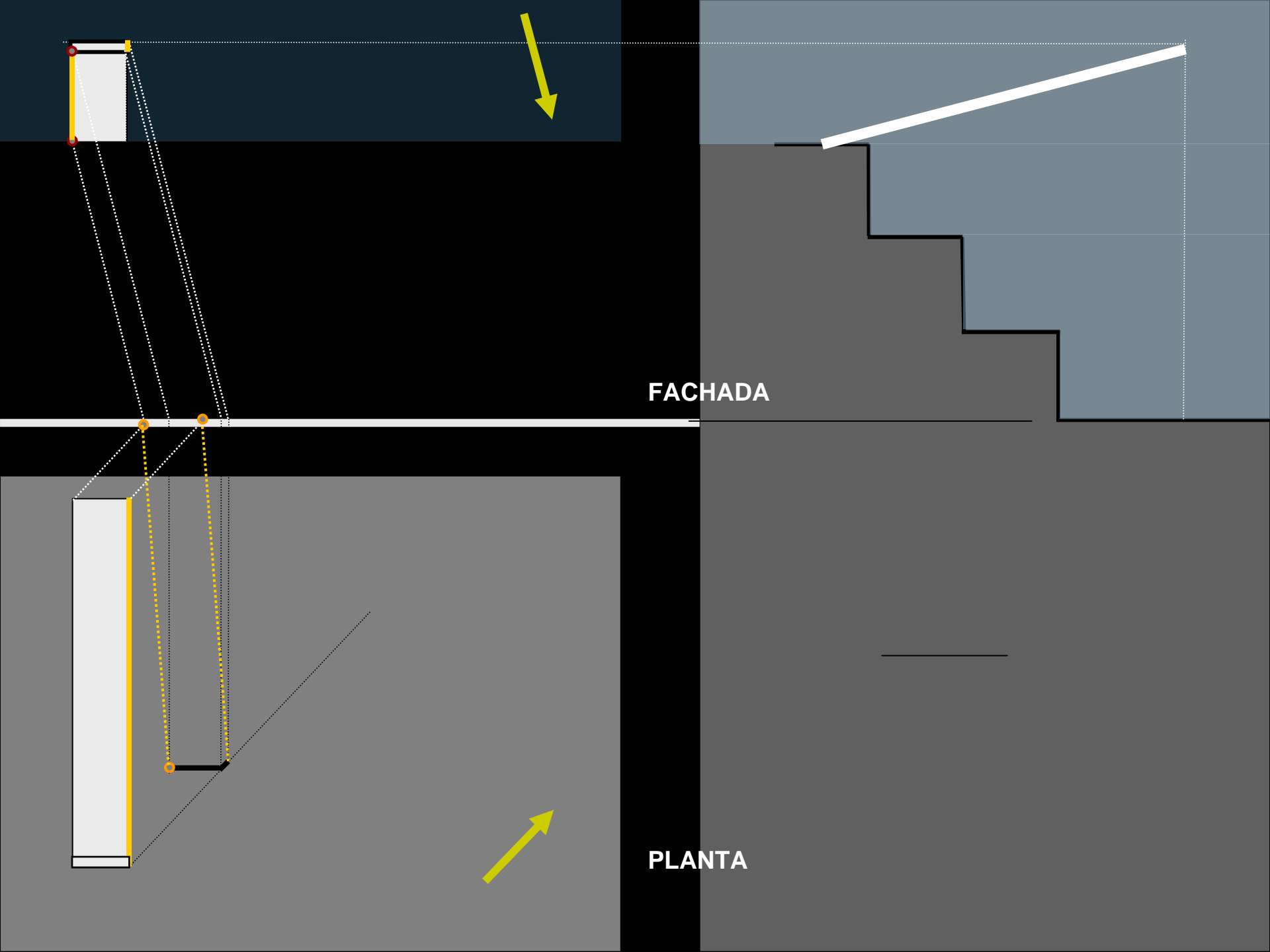

FACHADA

PLANTA

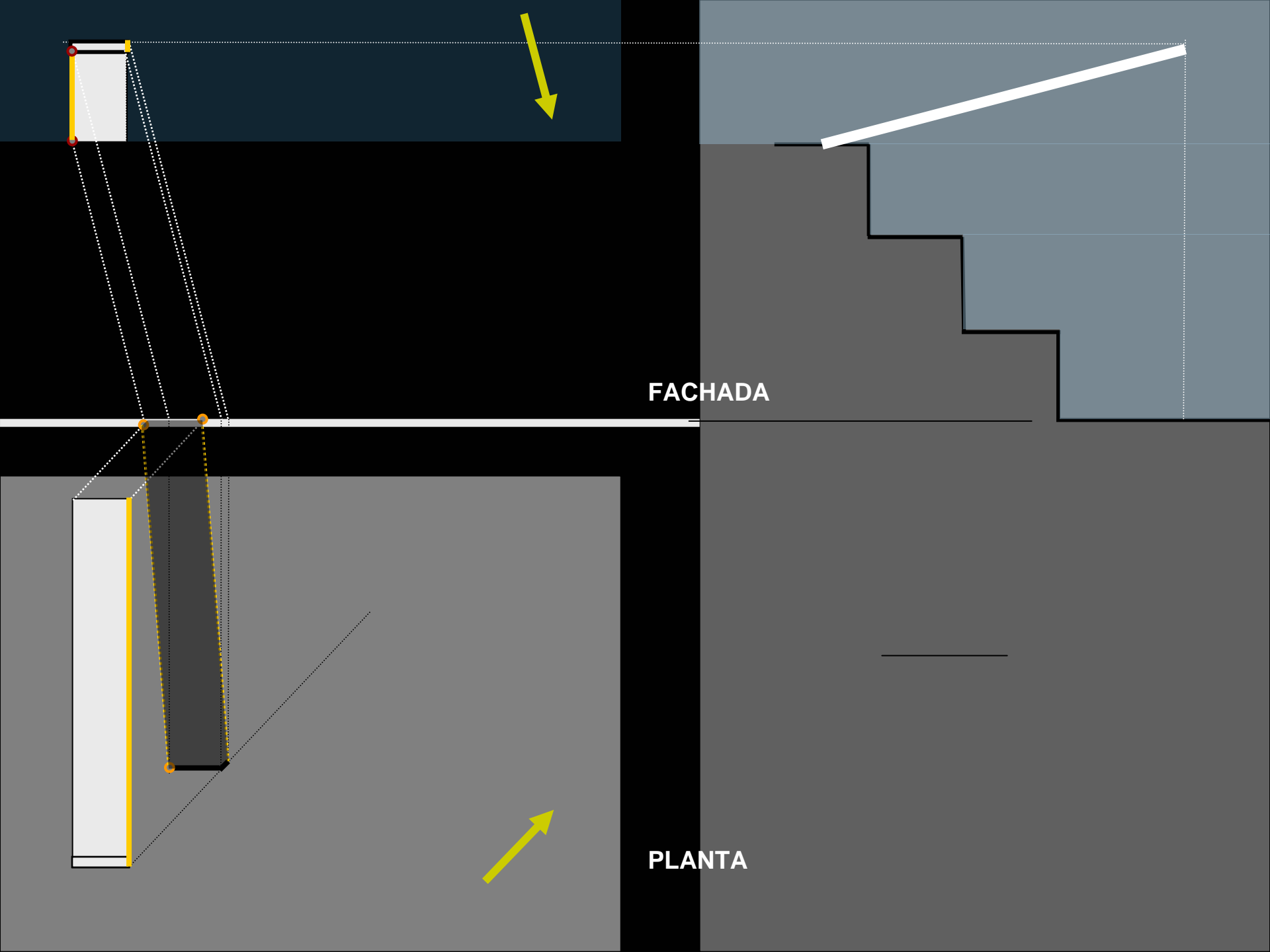

FACHADA

PLANTA

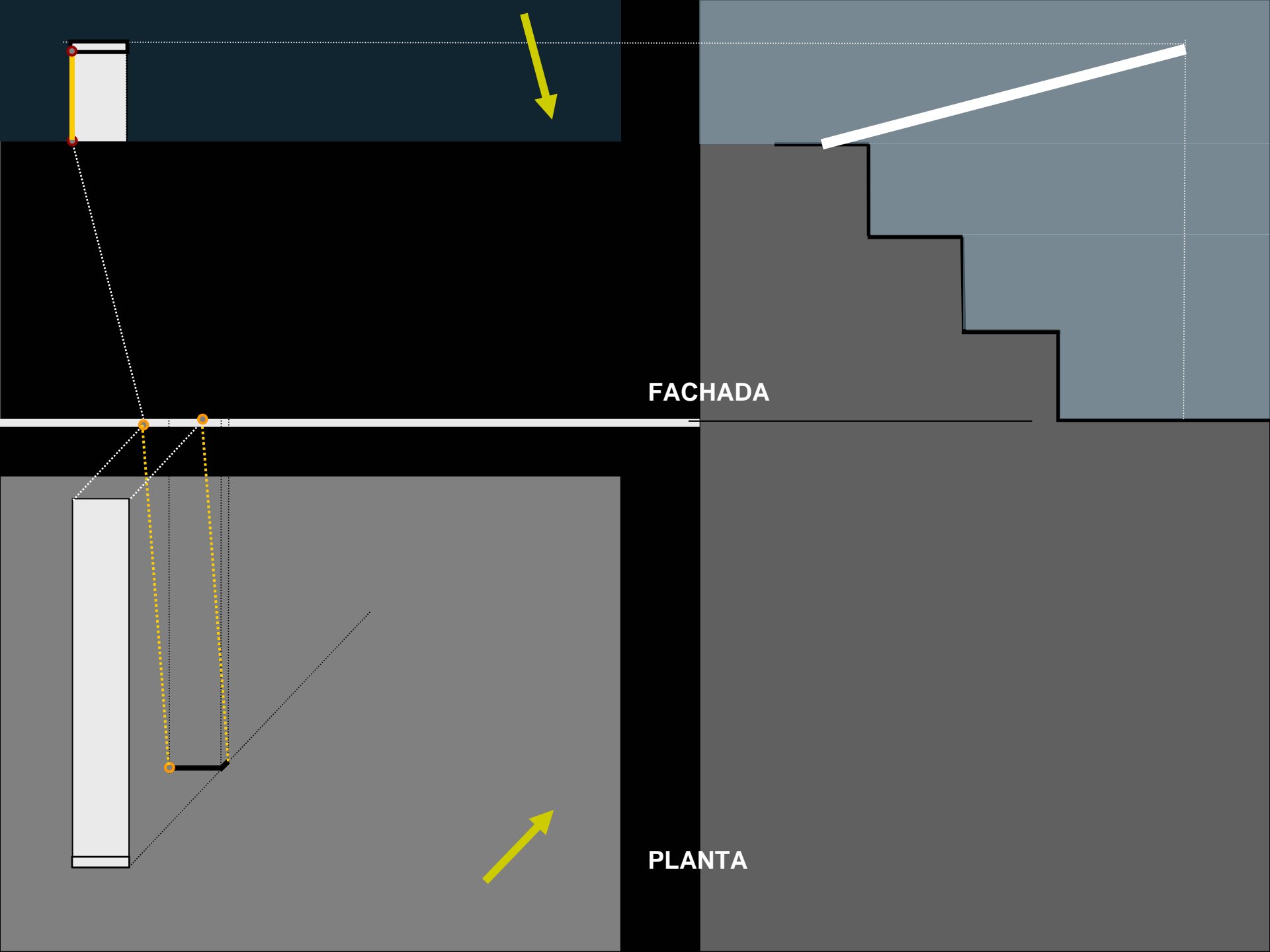

FACHADA

PLANTA

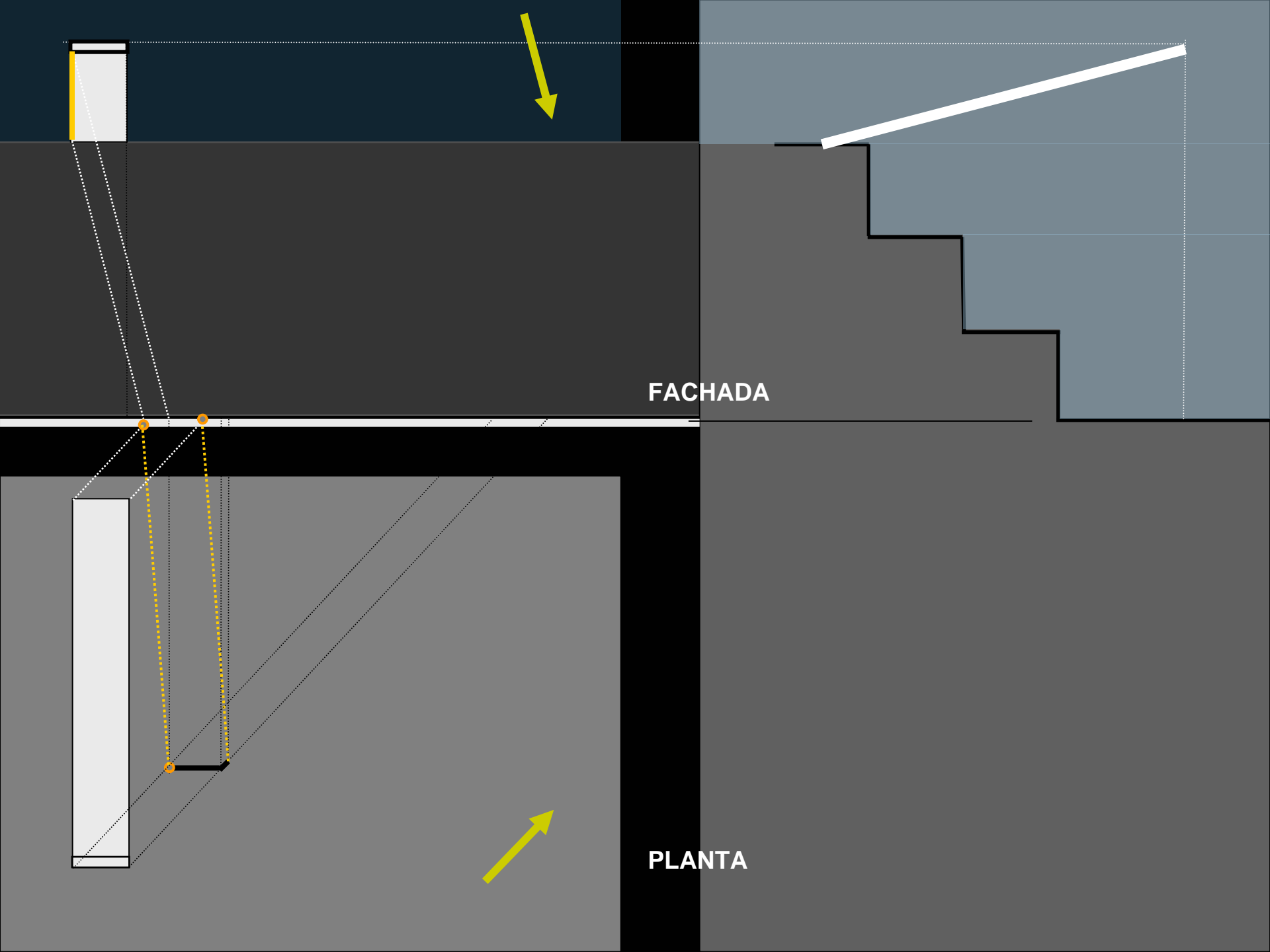

FACHADA

PLANTA

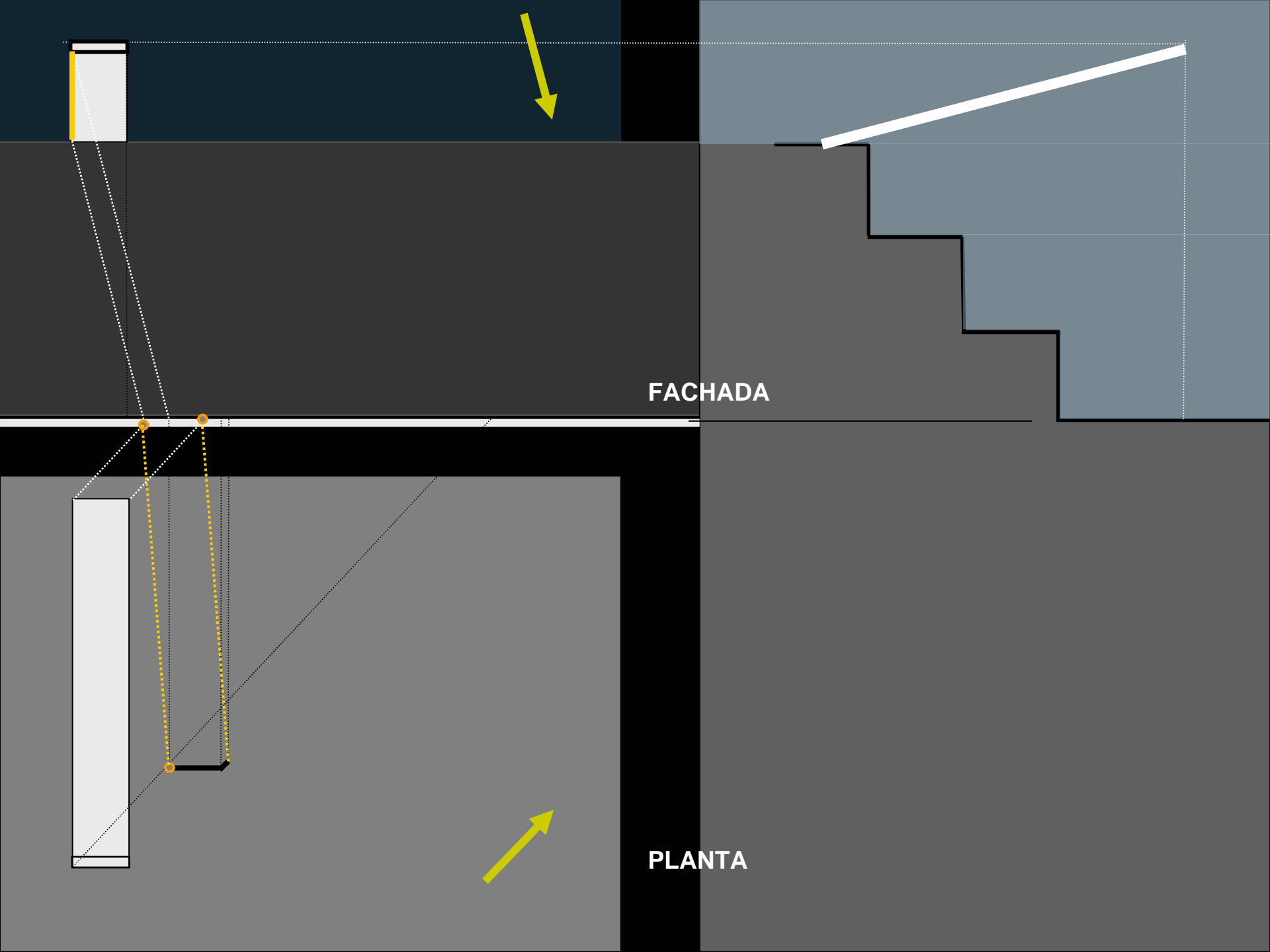

FACHADA

PLANTA

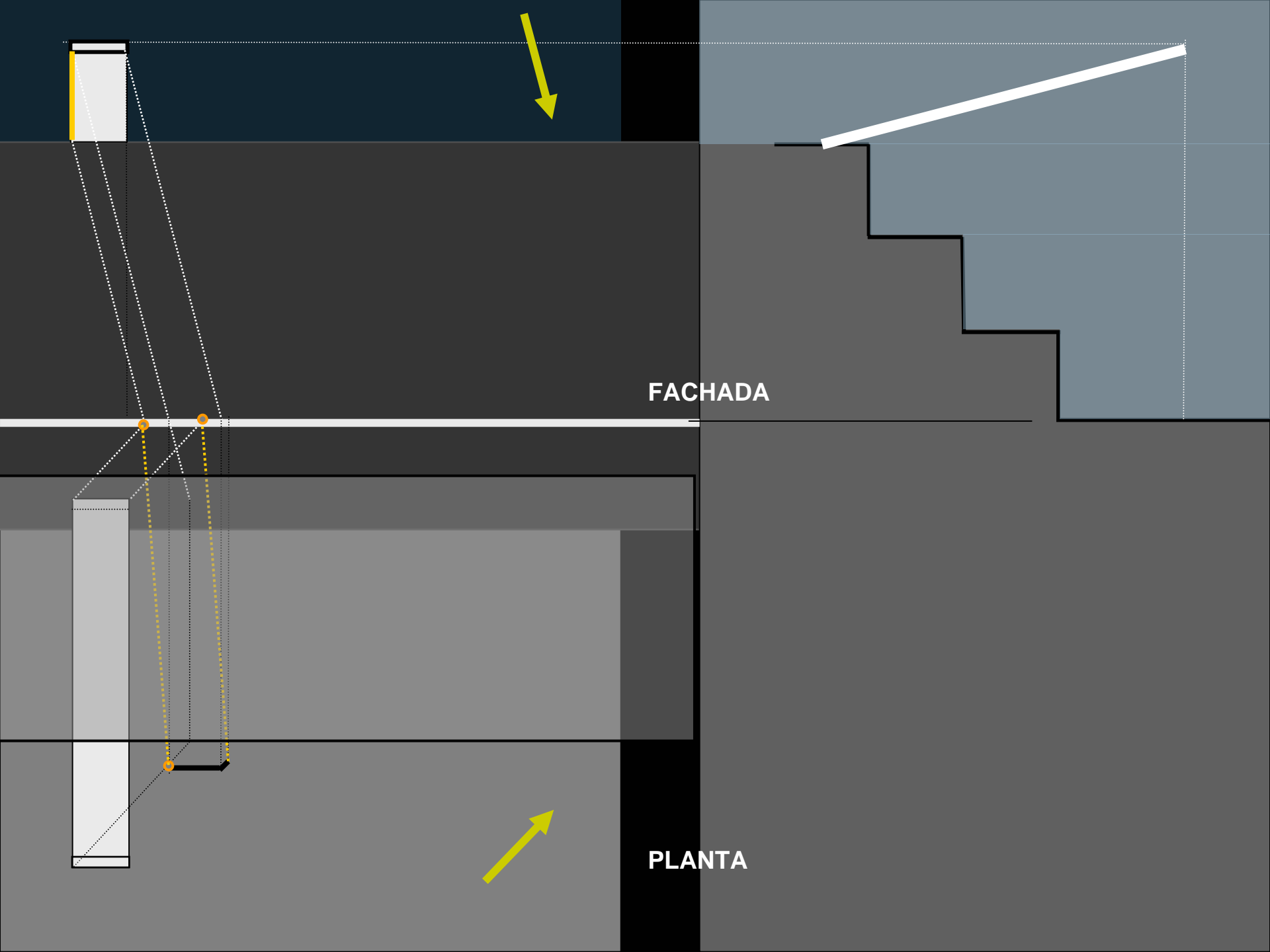

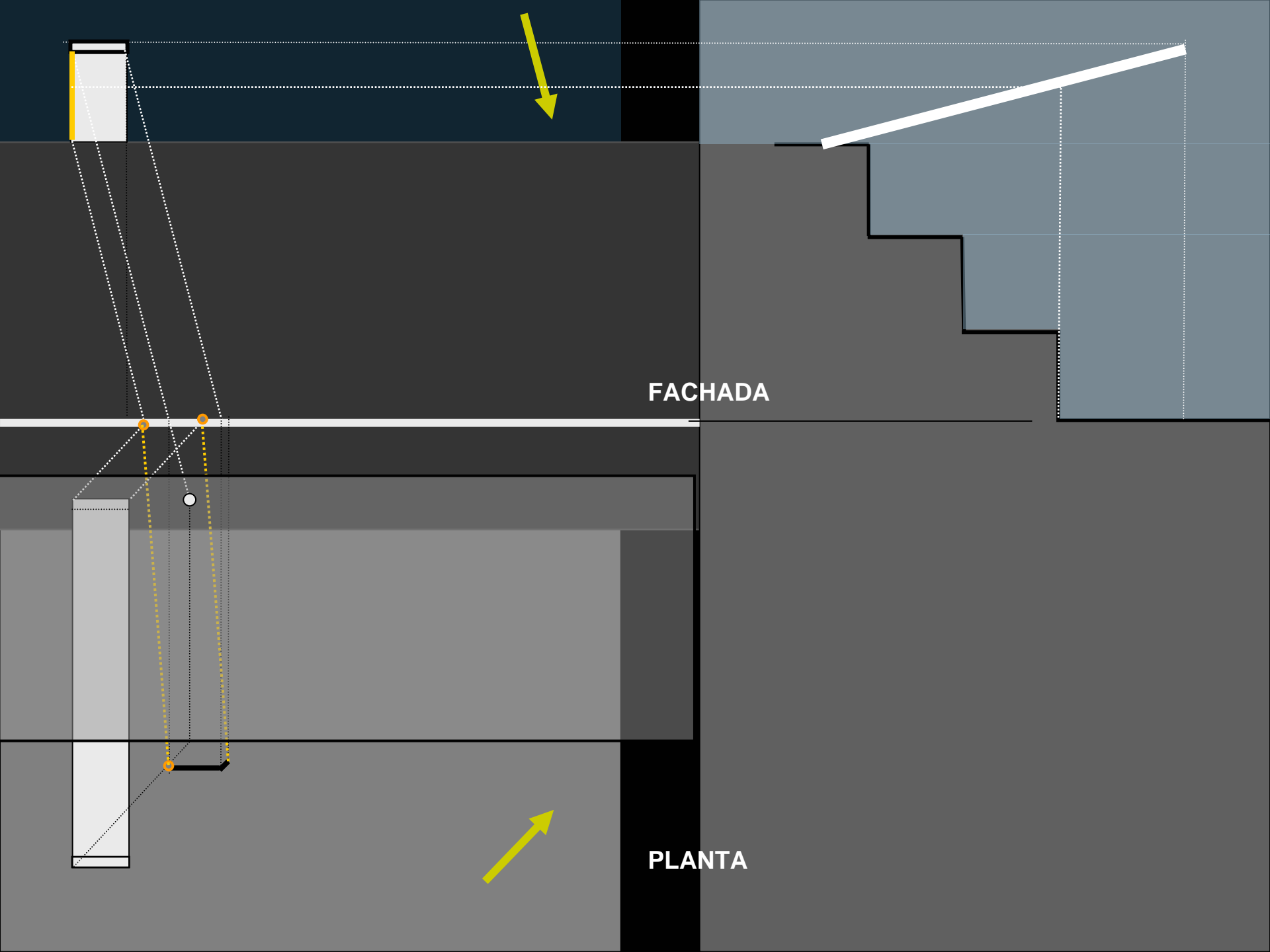

FACHADA

PLANTA

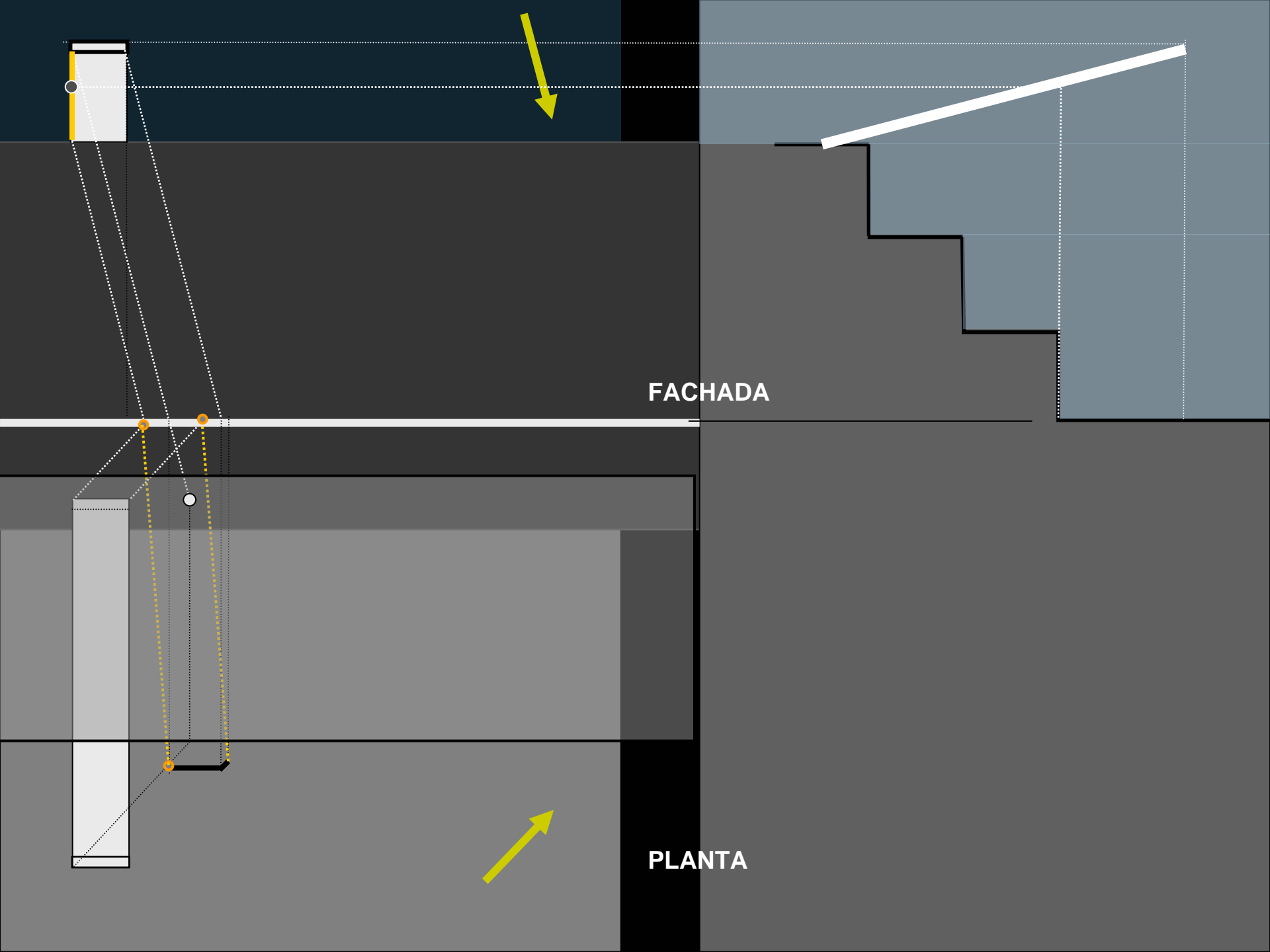

FACHADA

PLANTA

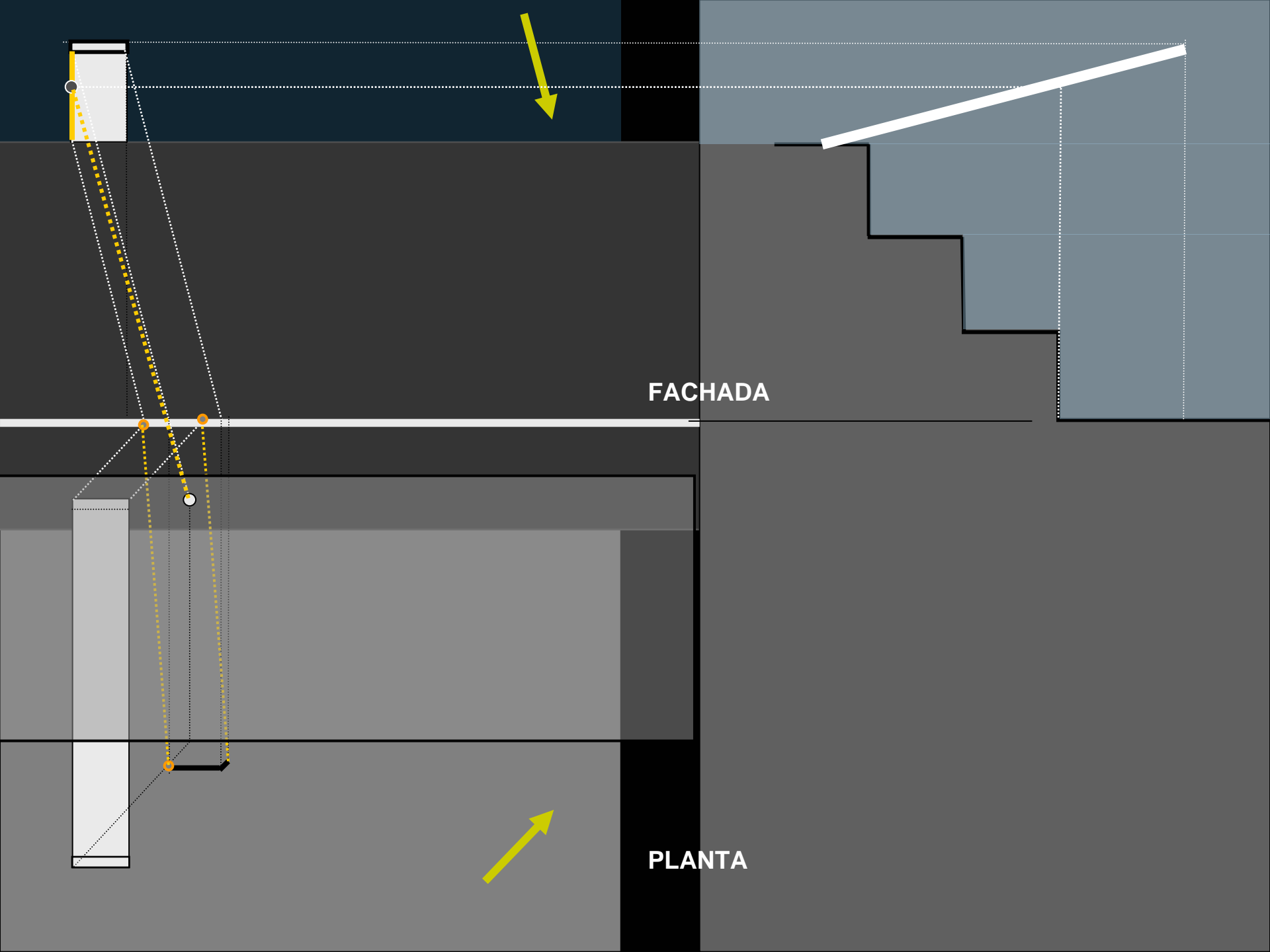

FACHADA

PLANTA

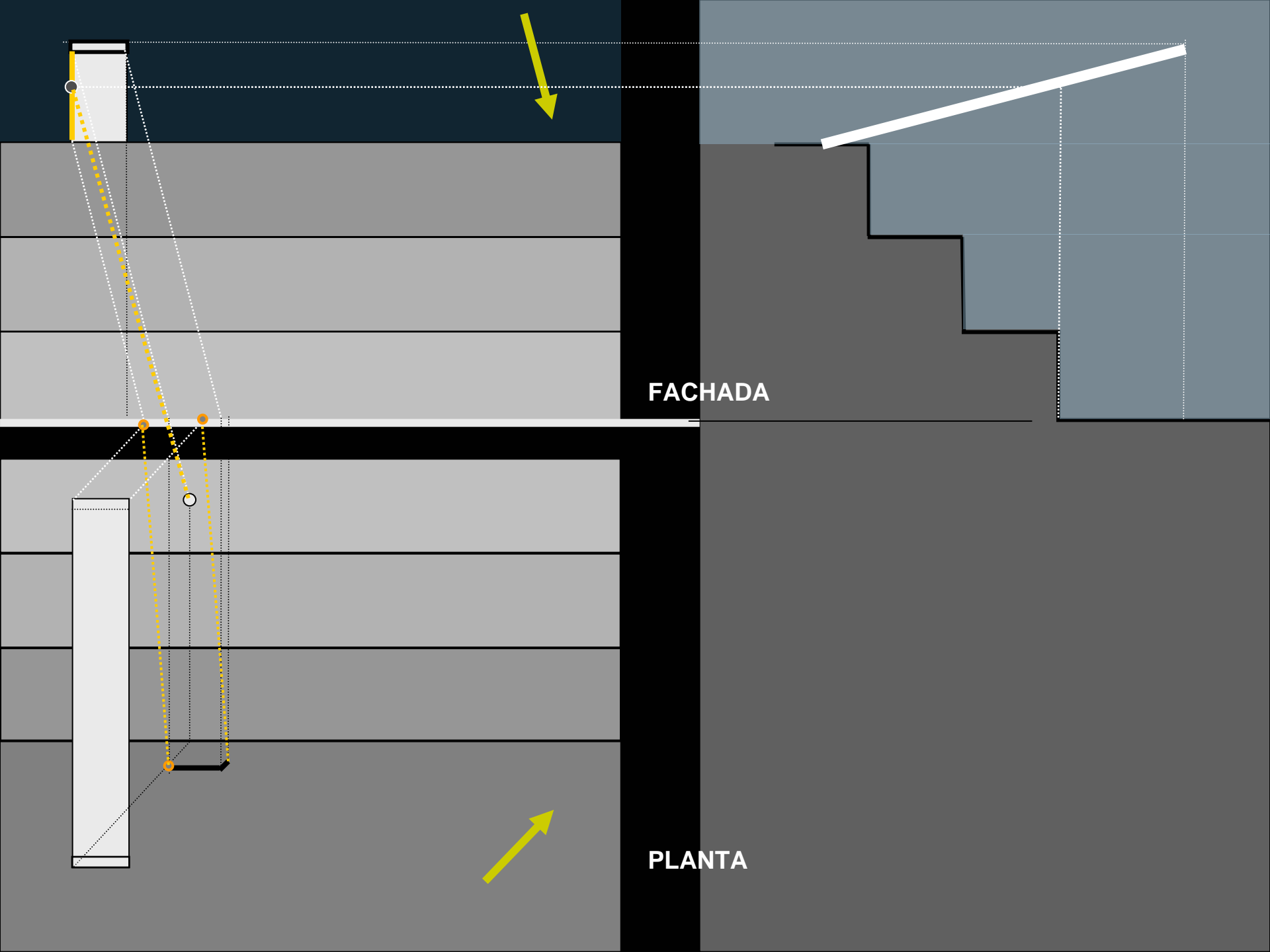

FACHADA

PLANTA

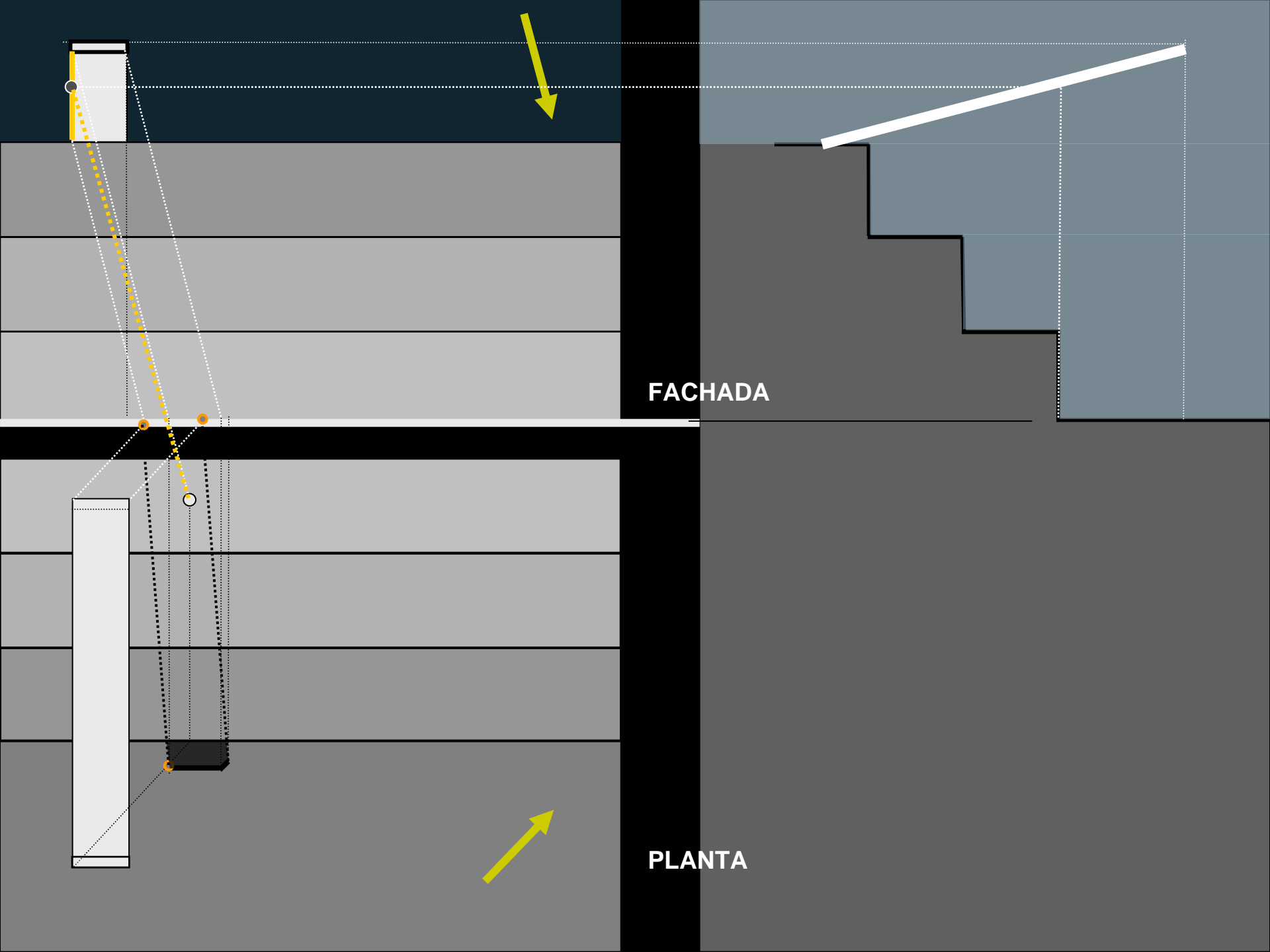

FACHADA

PLANTA

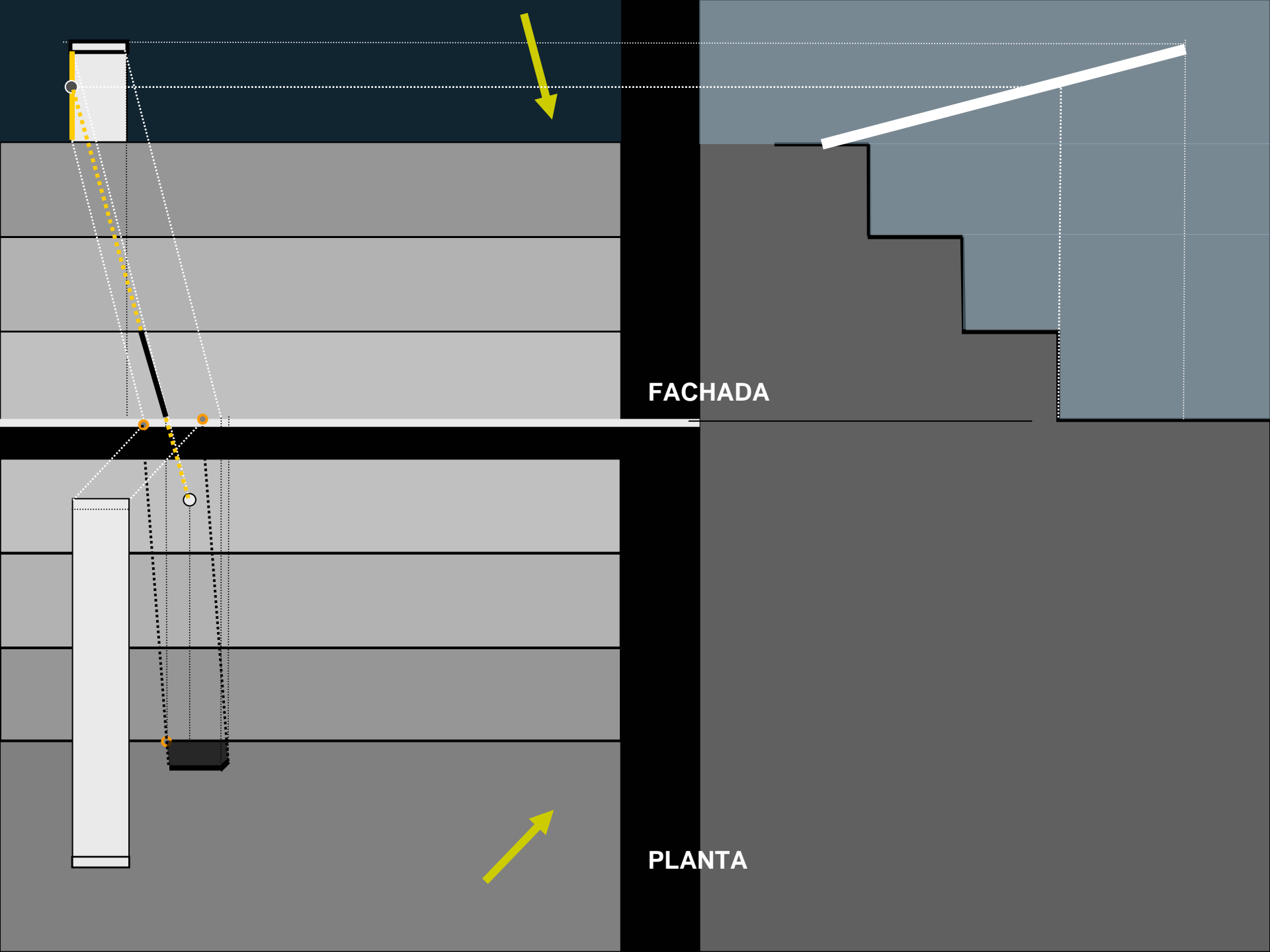

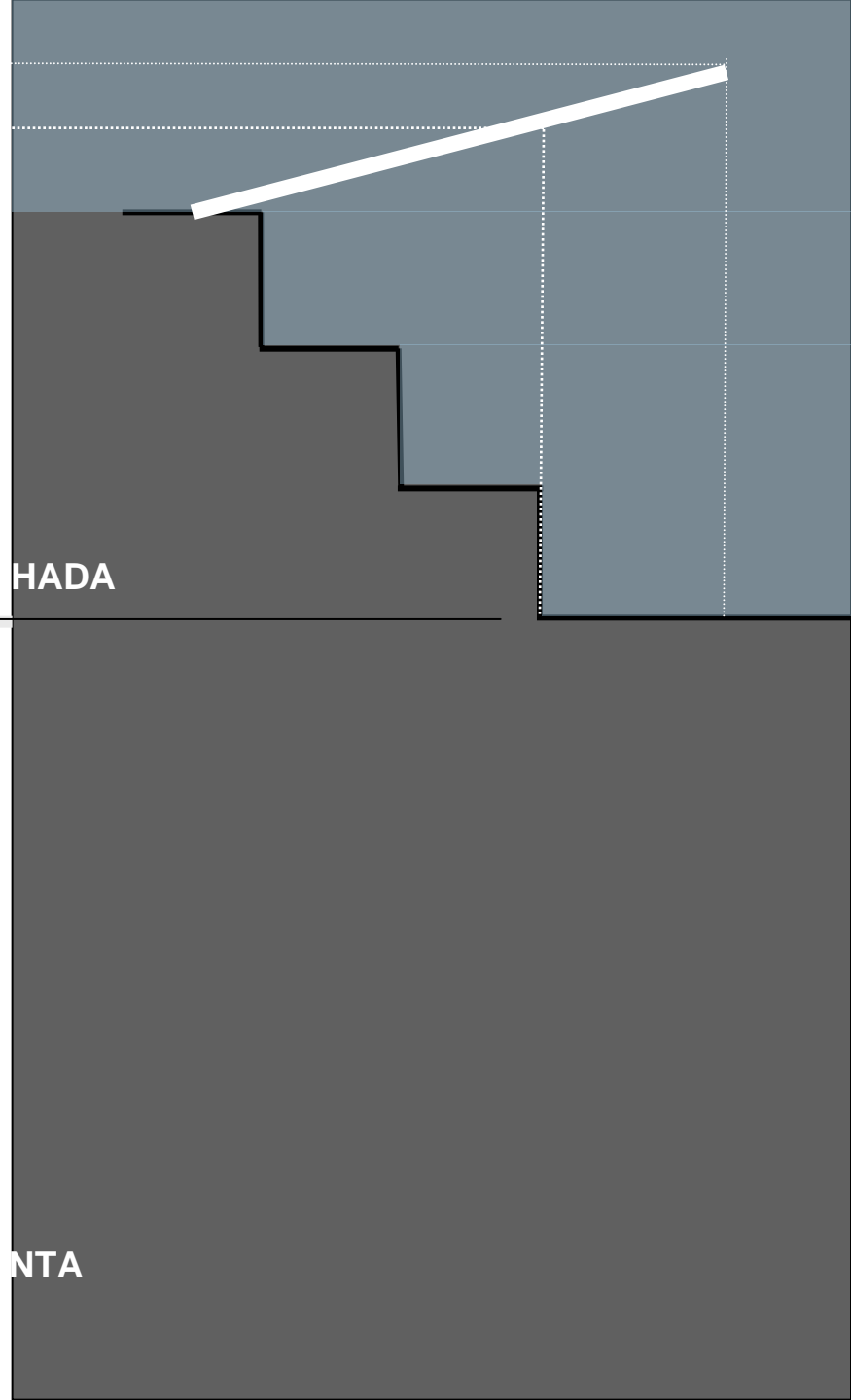
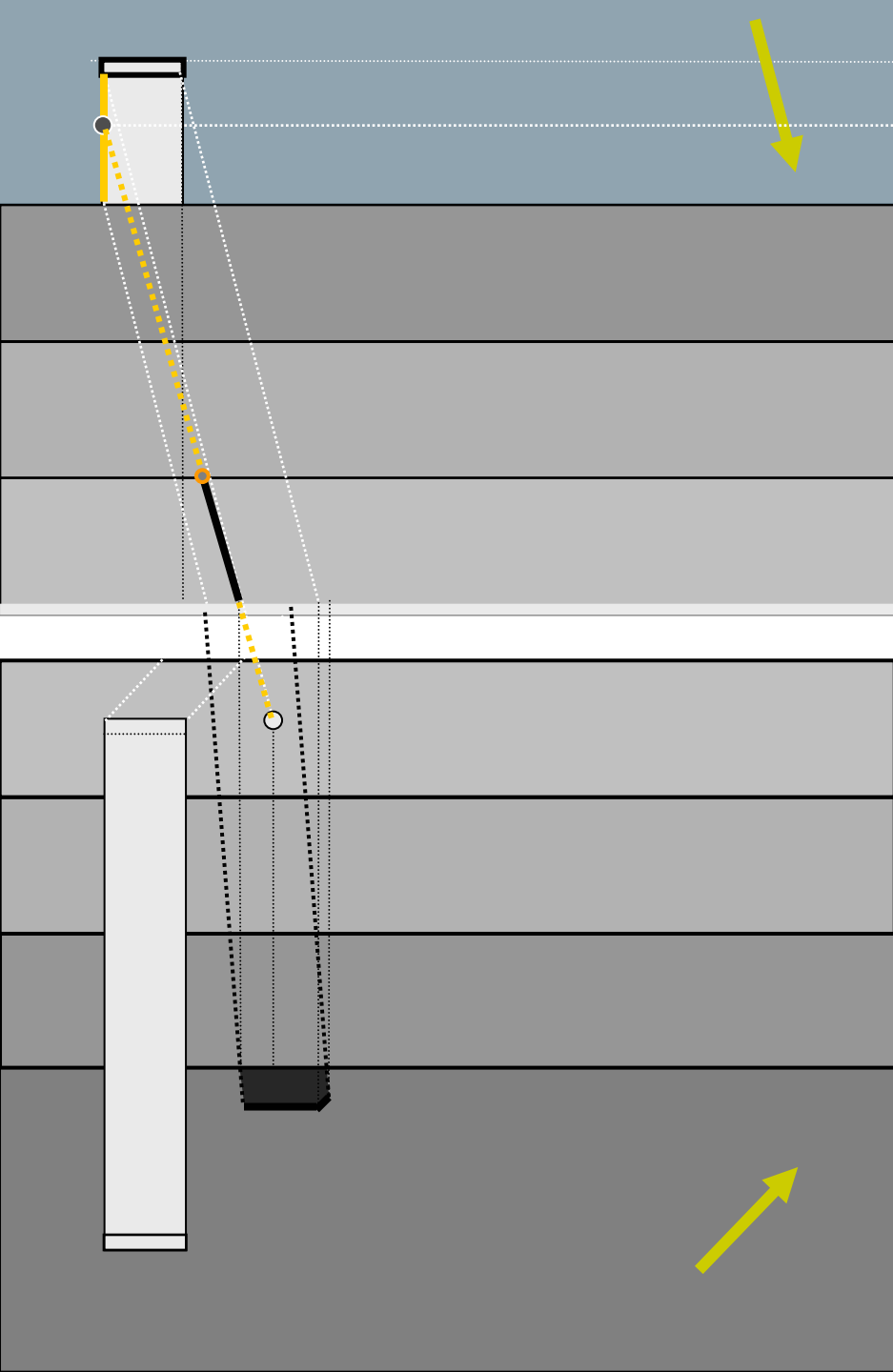

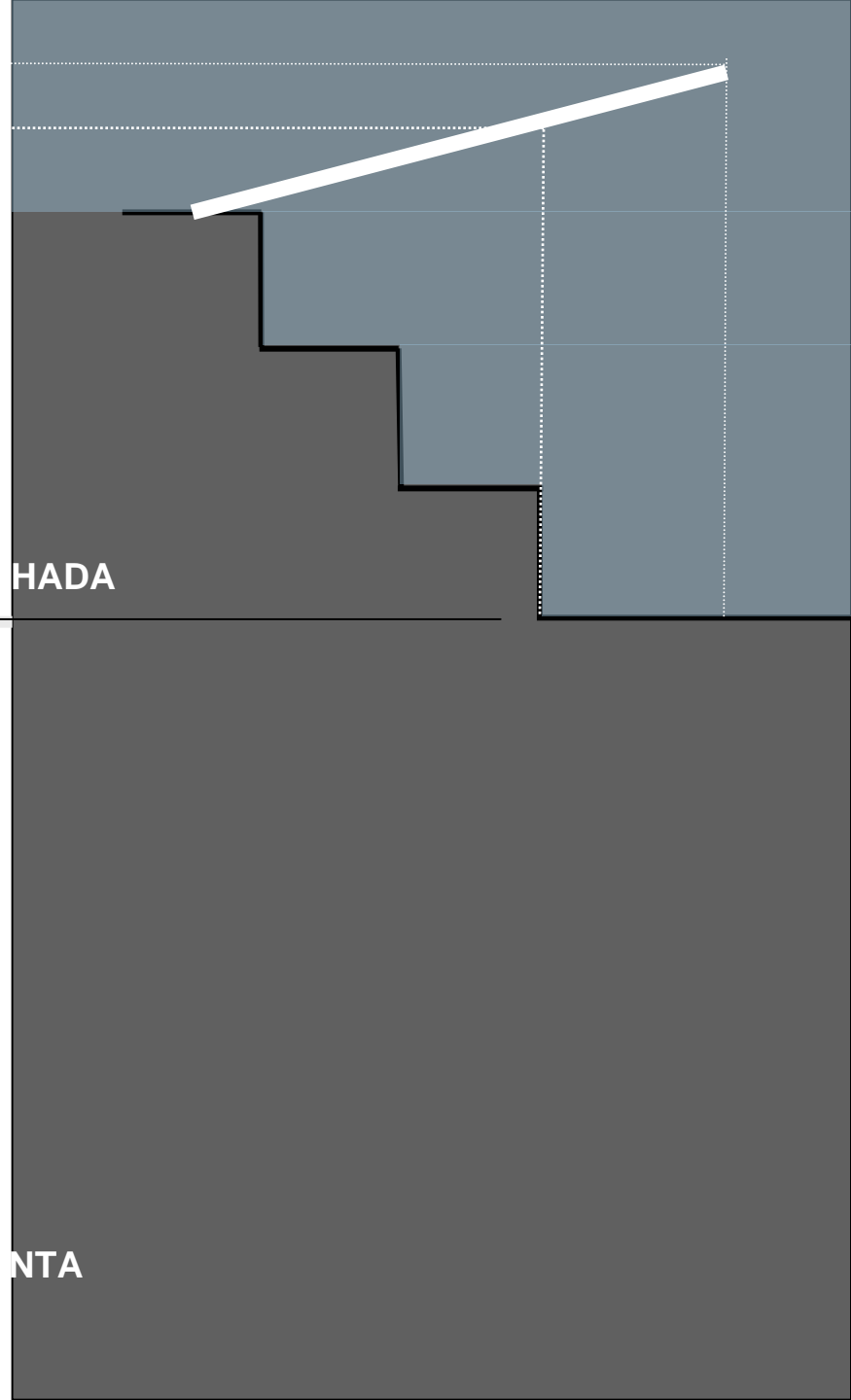
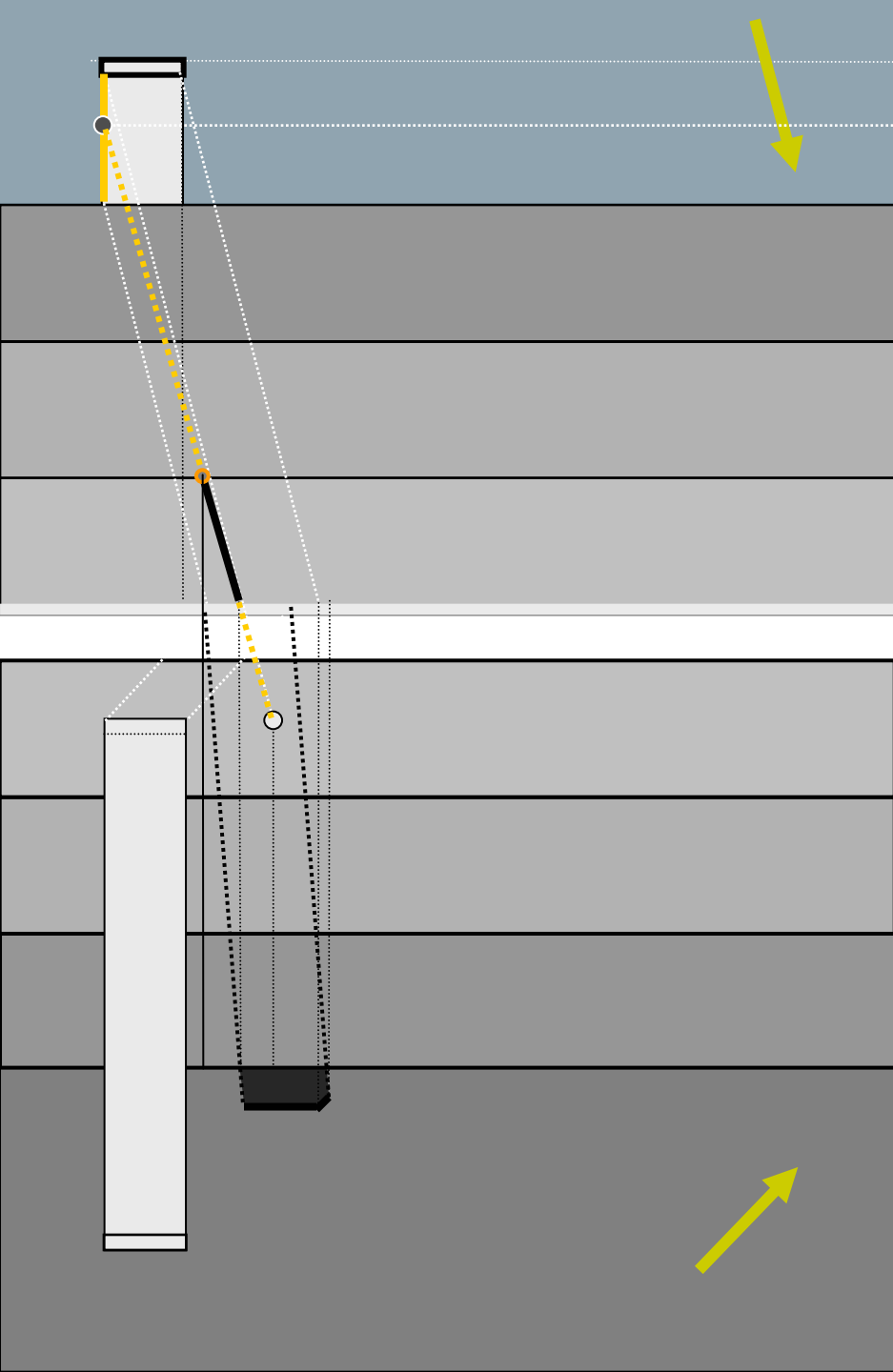

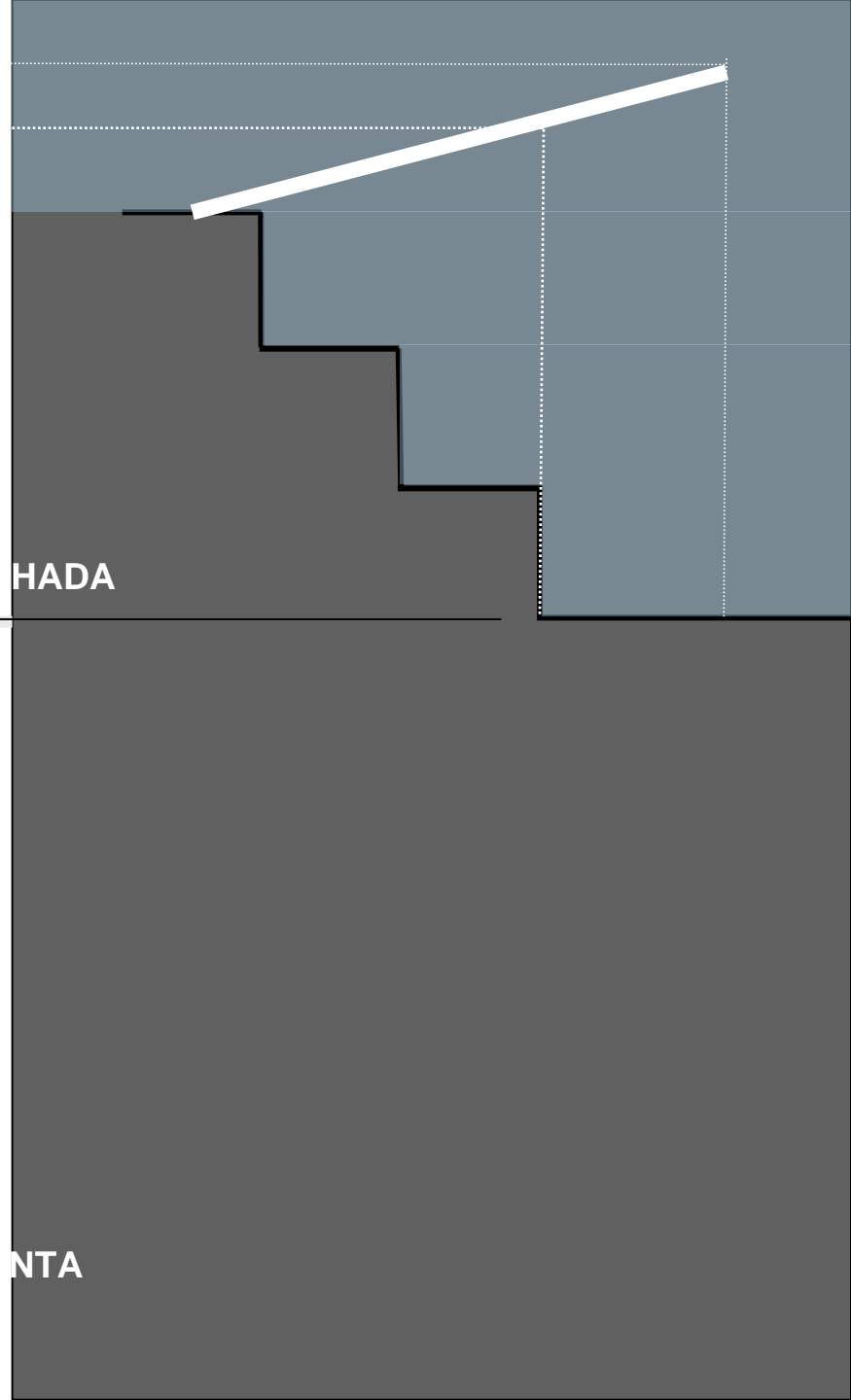
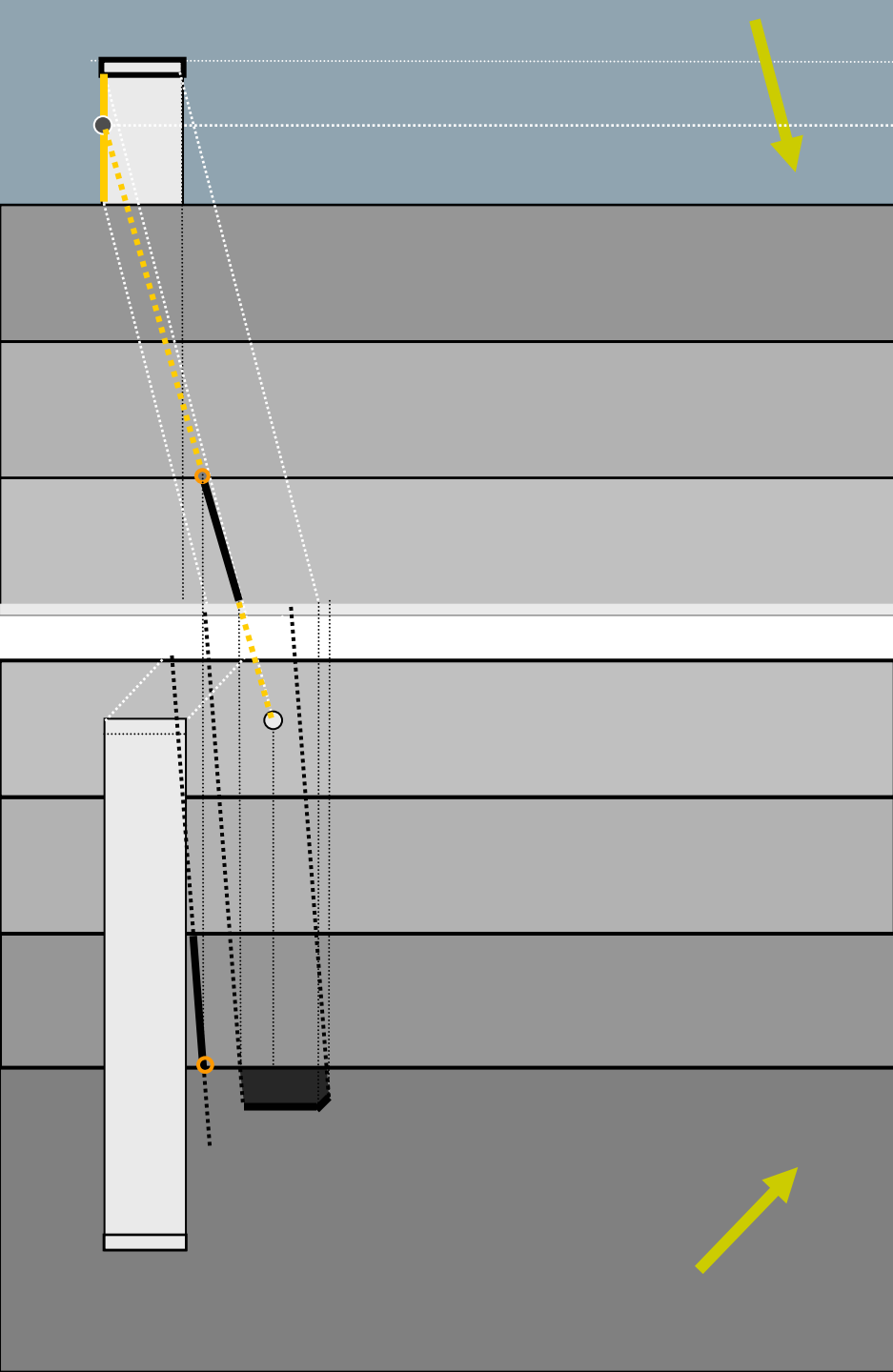

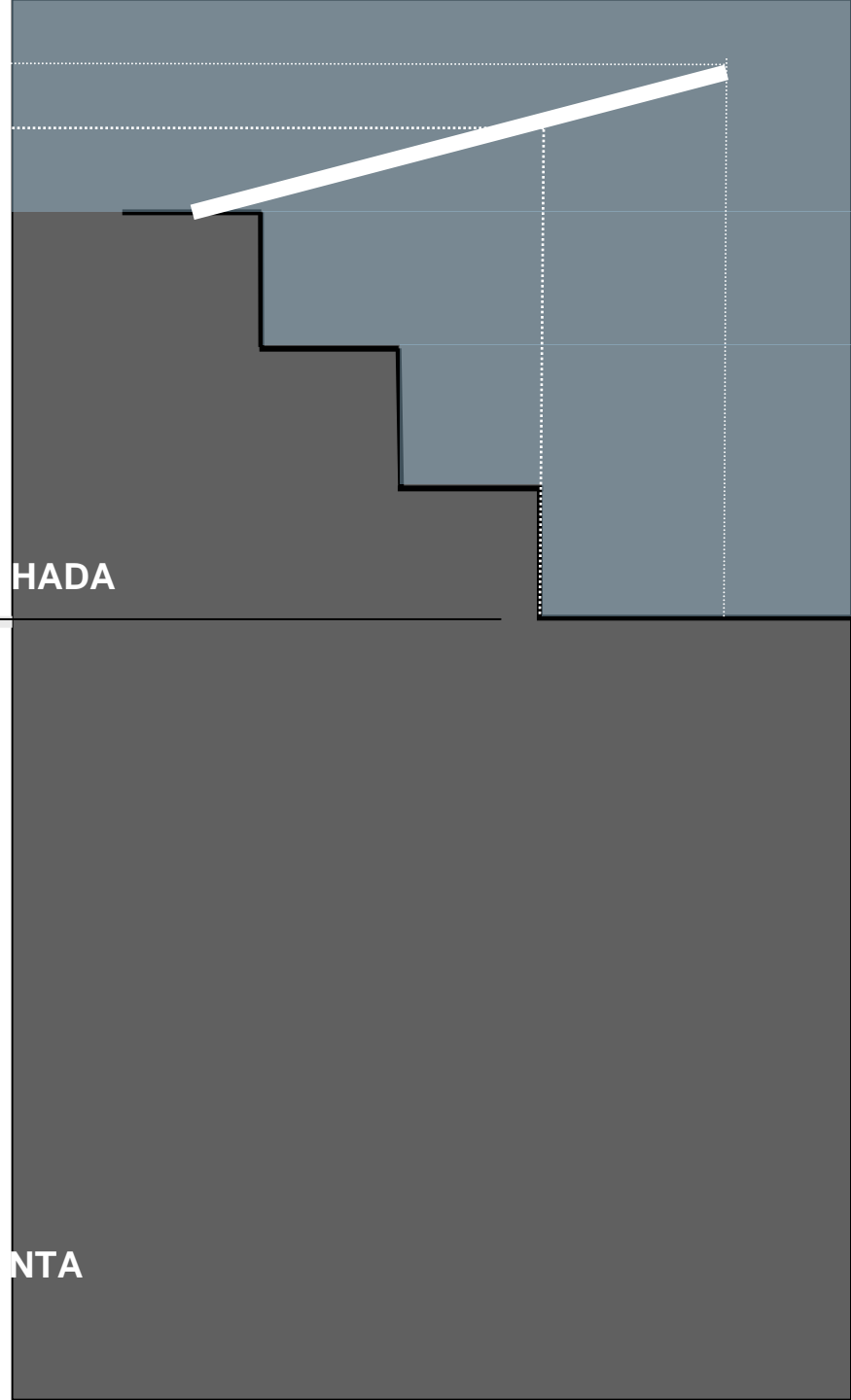
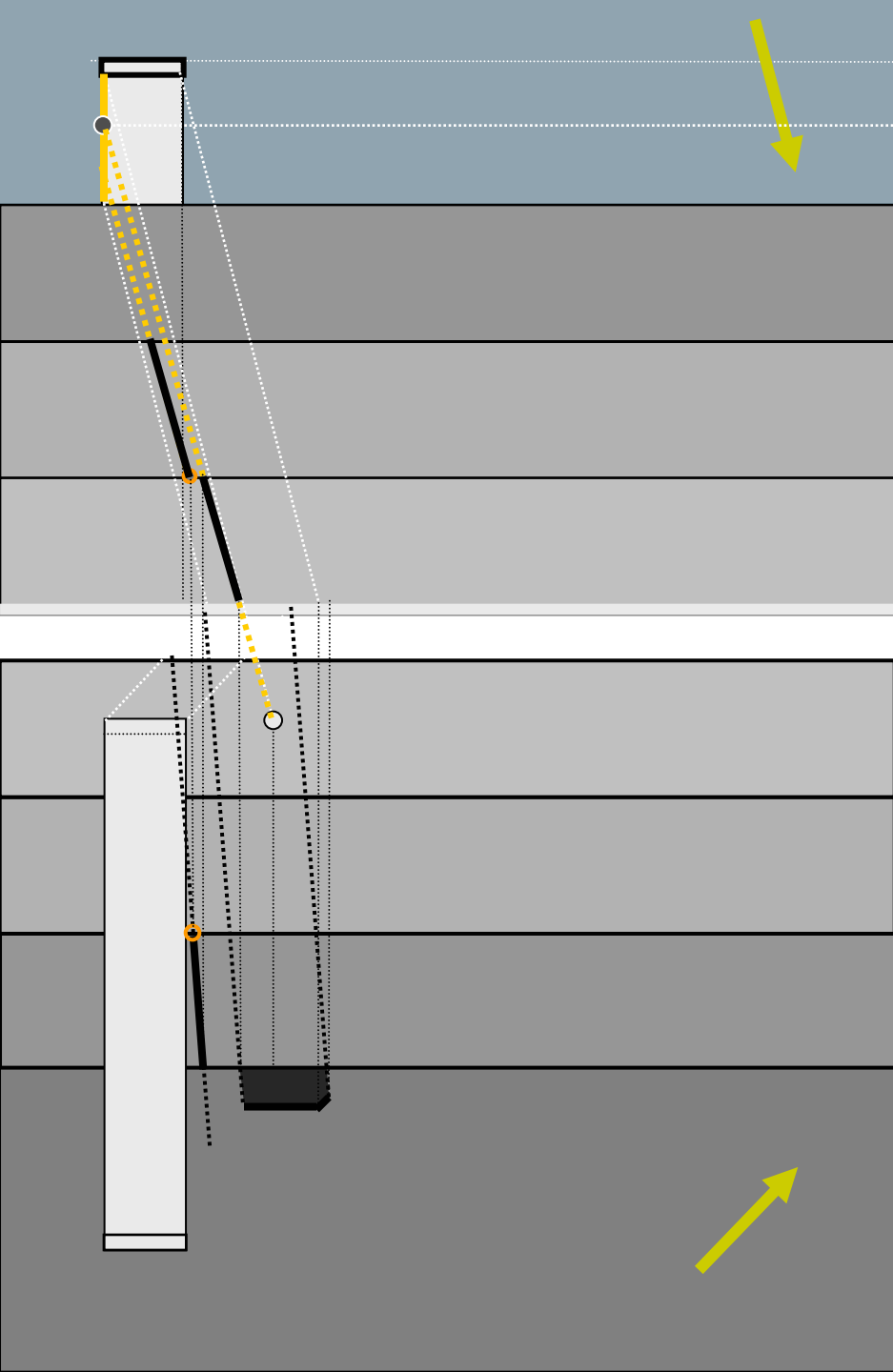

HADA

NTA

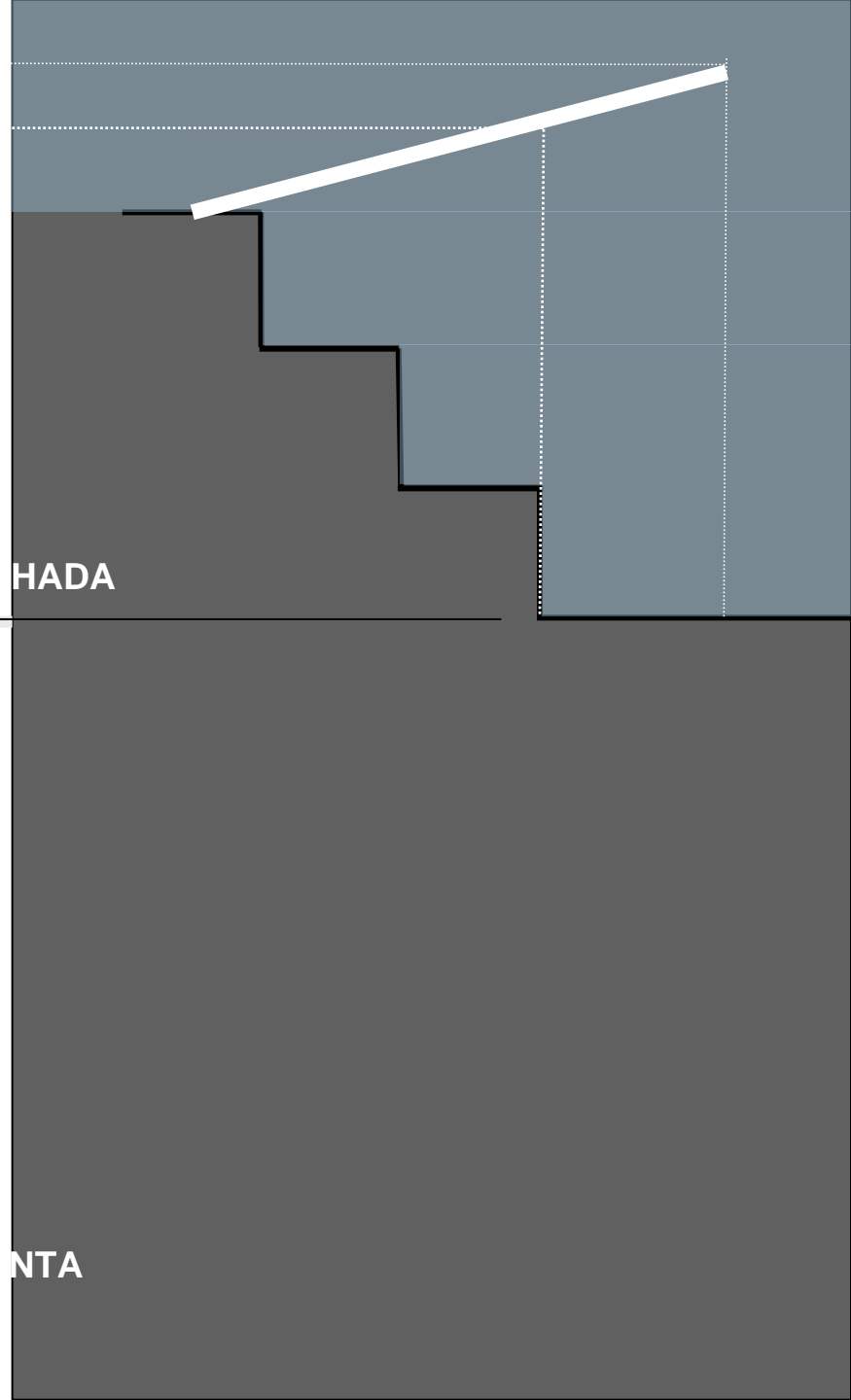
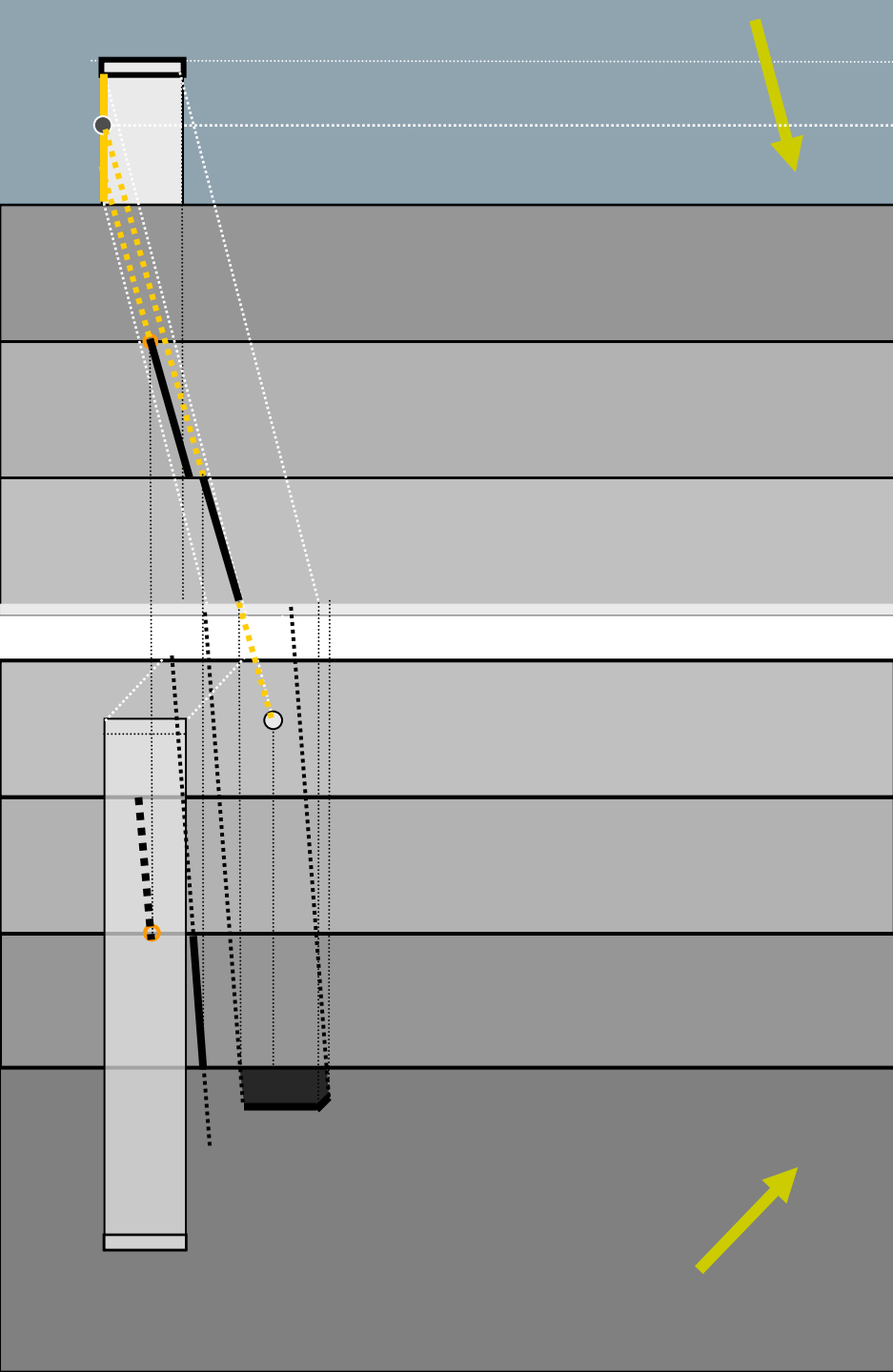

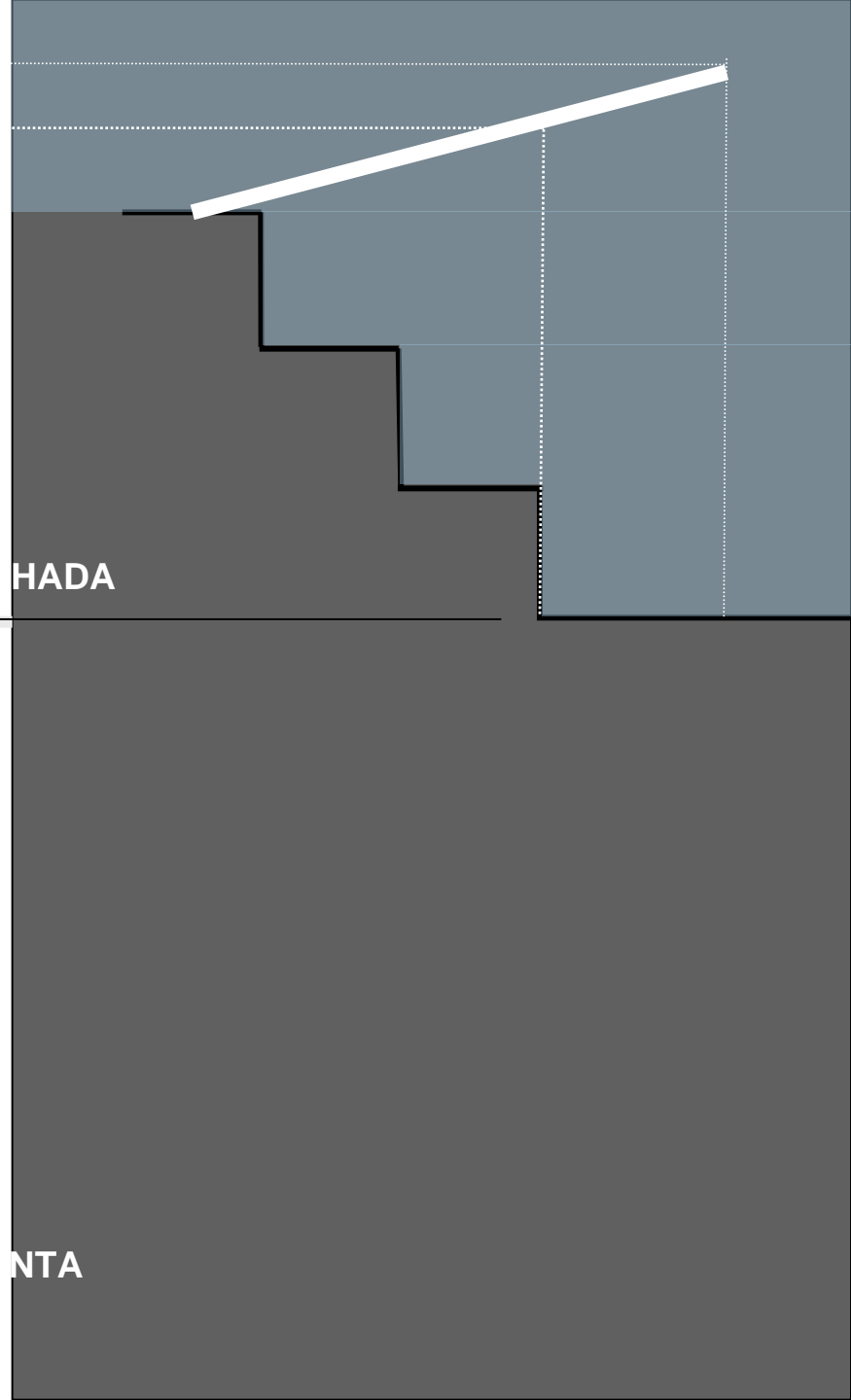
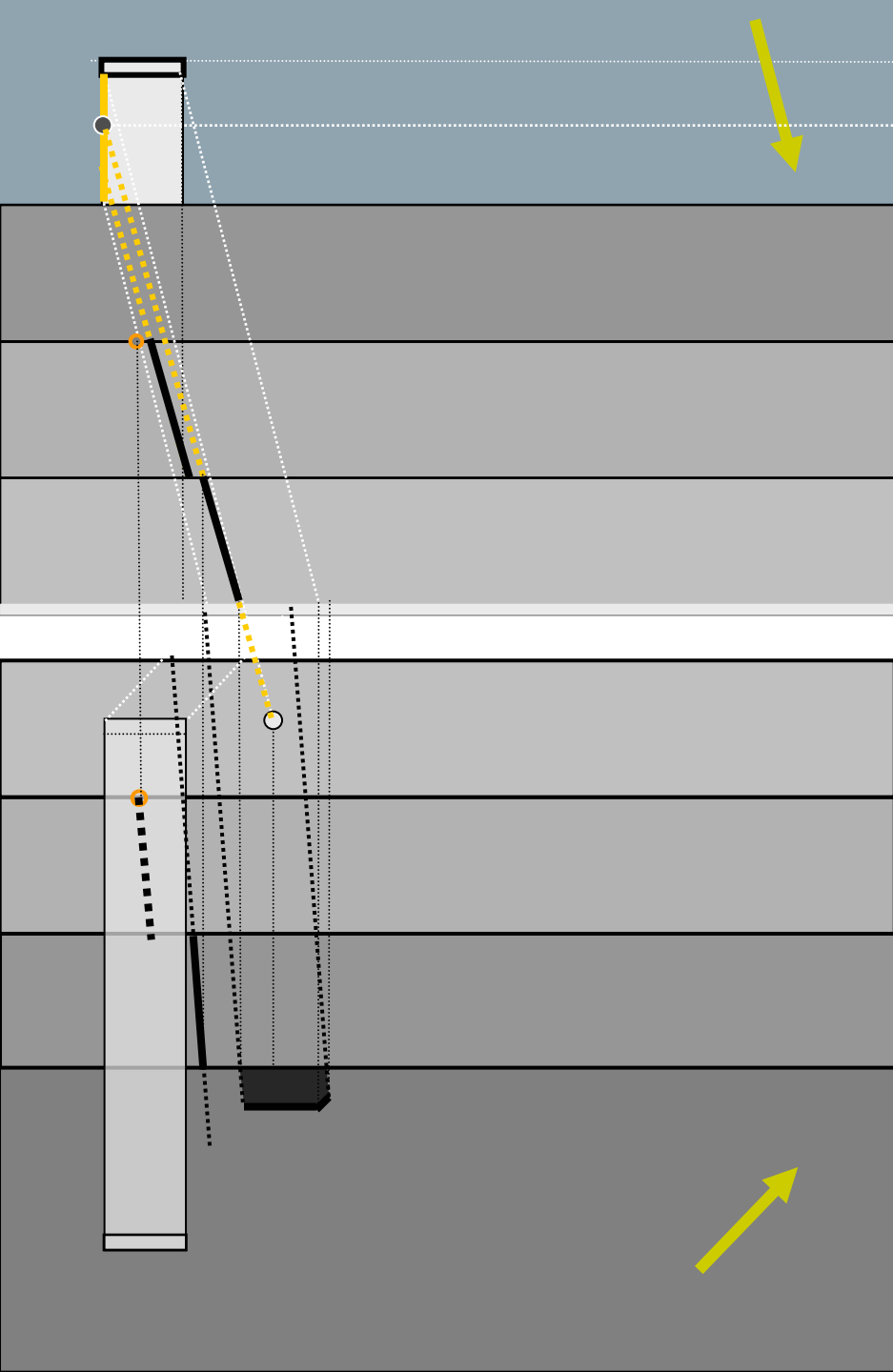

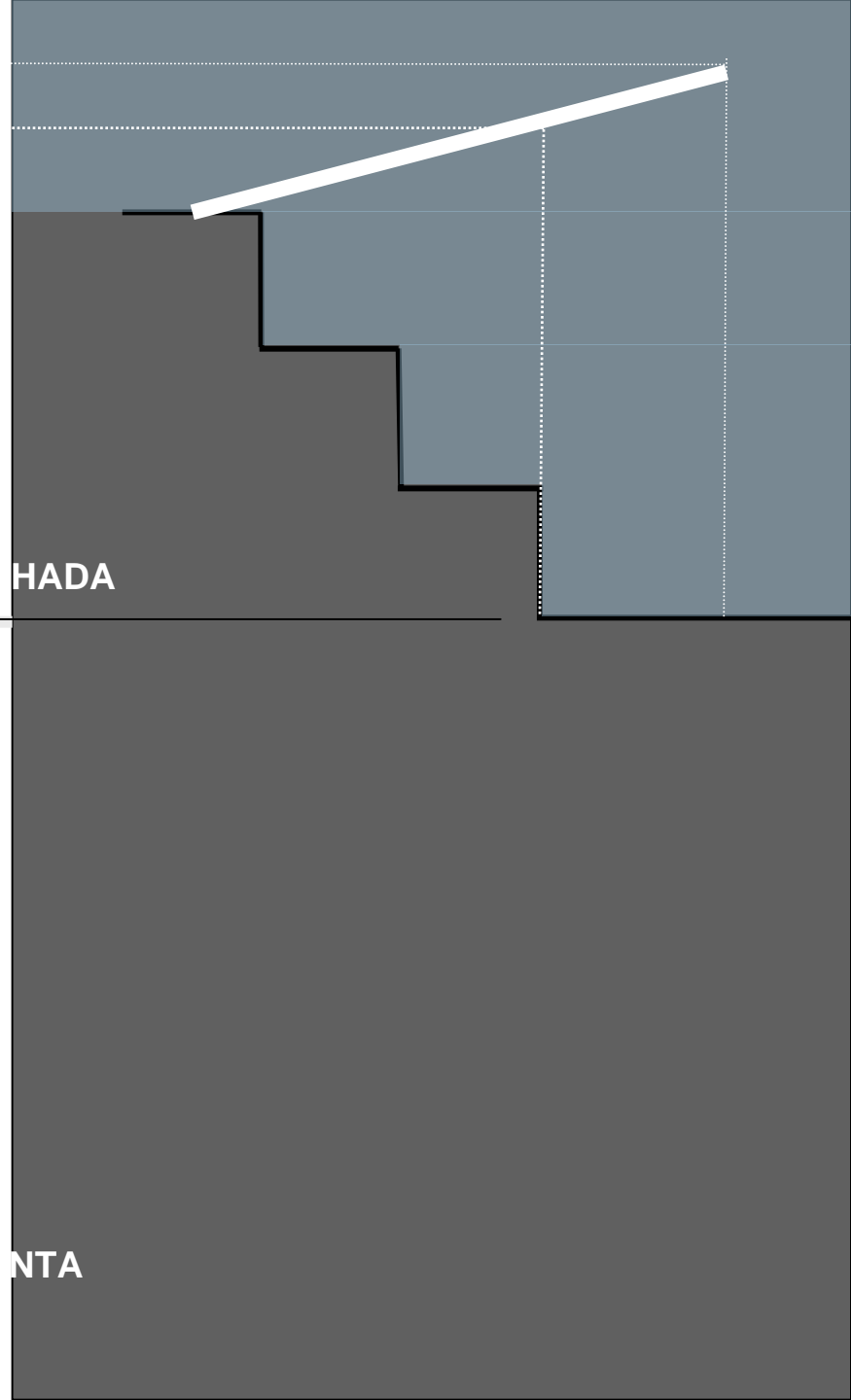
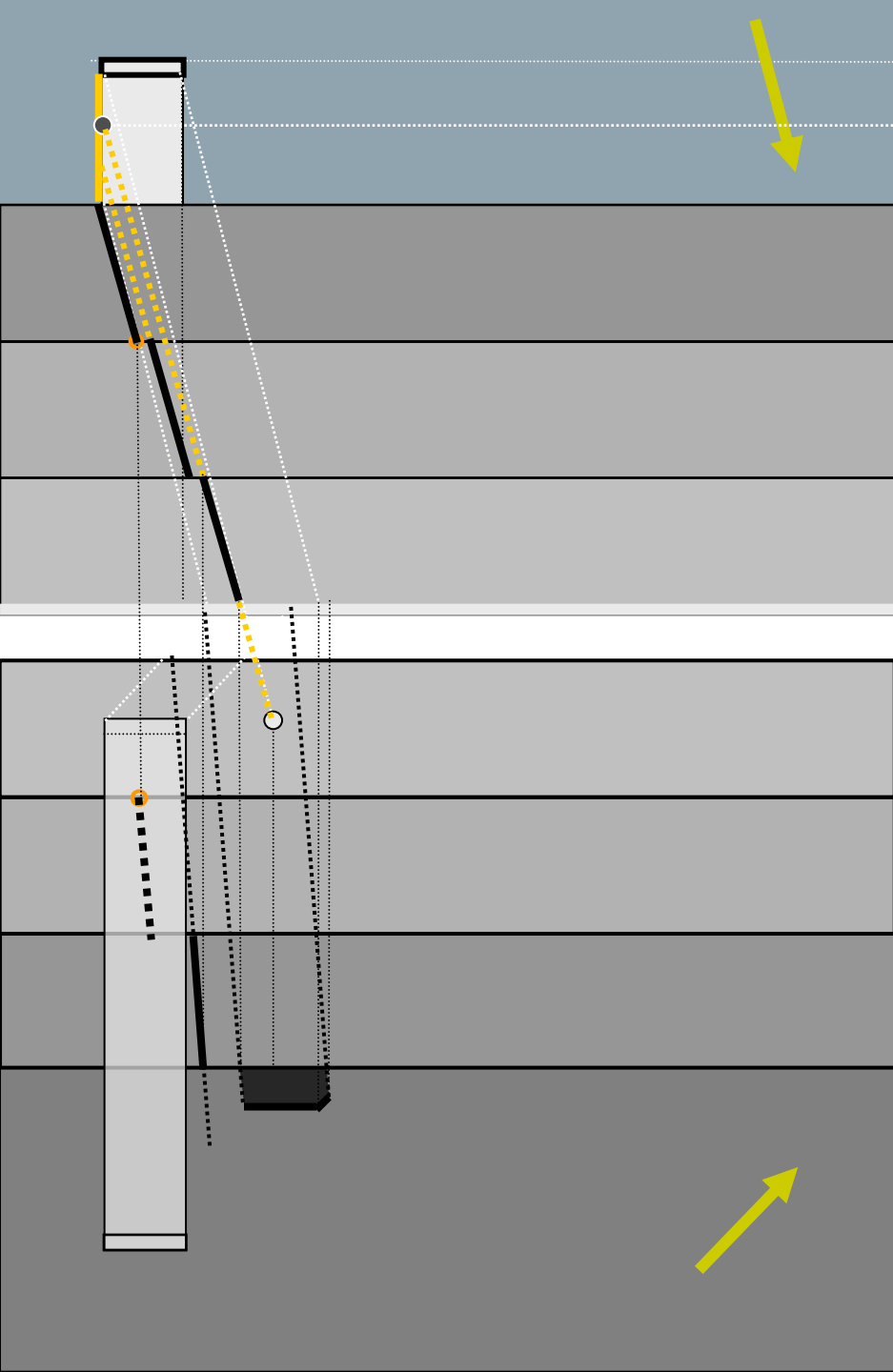

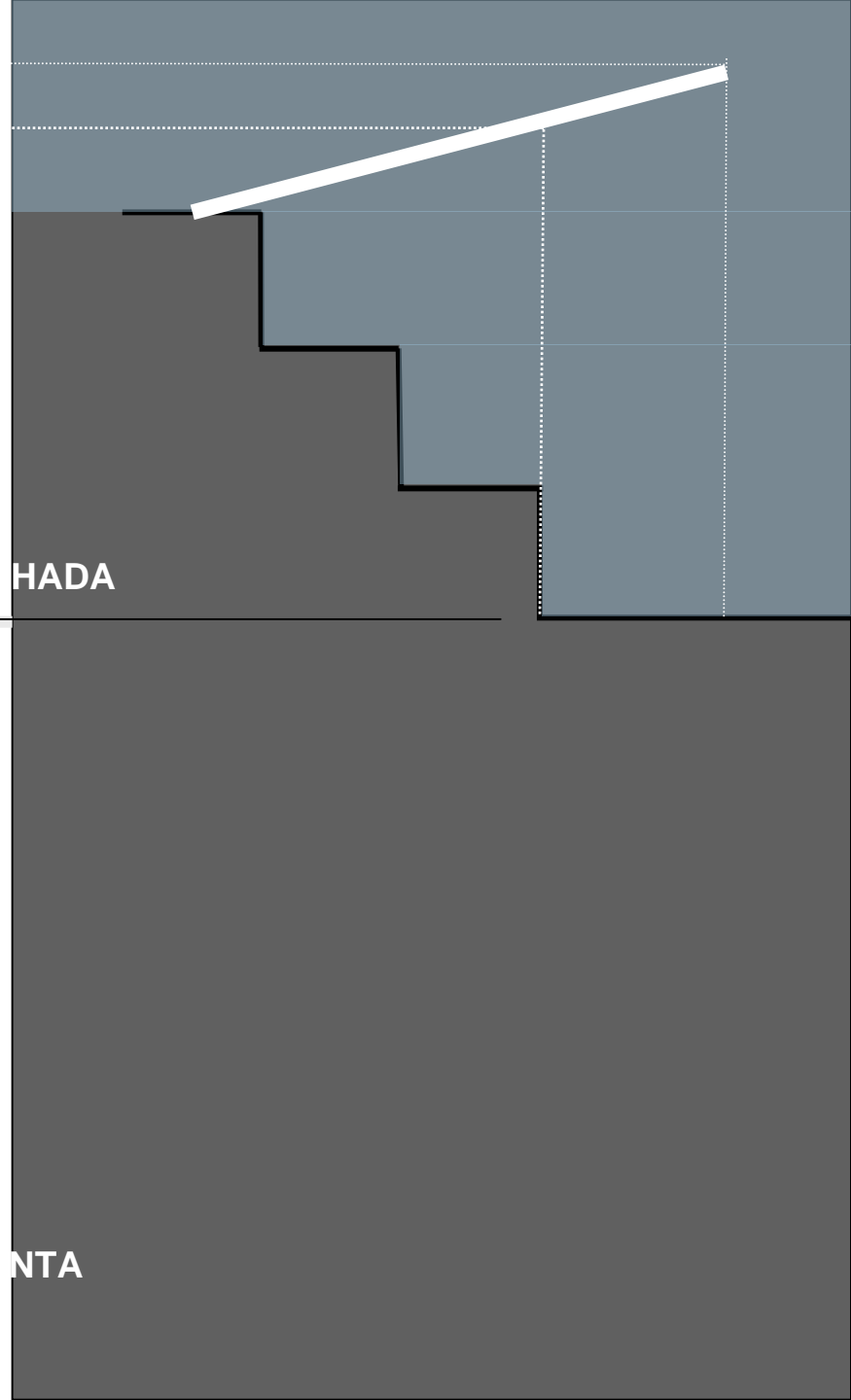
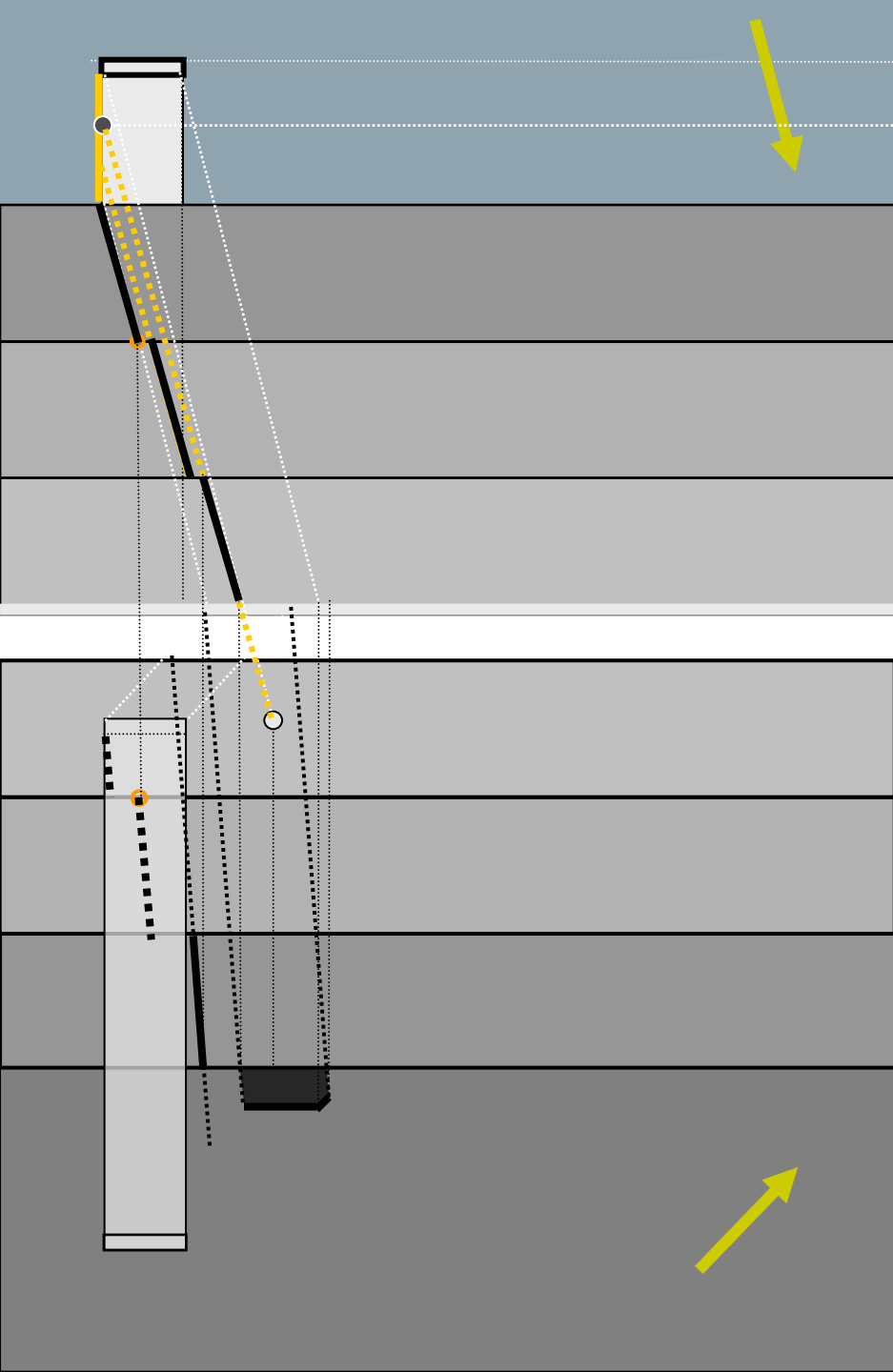

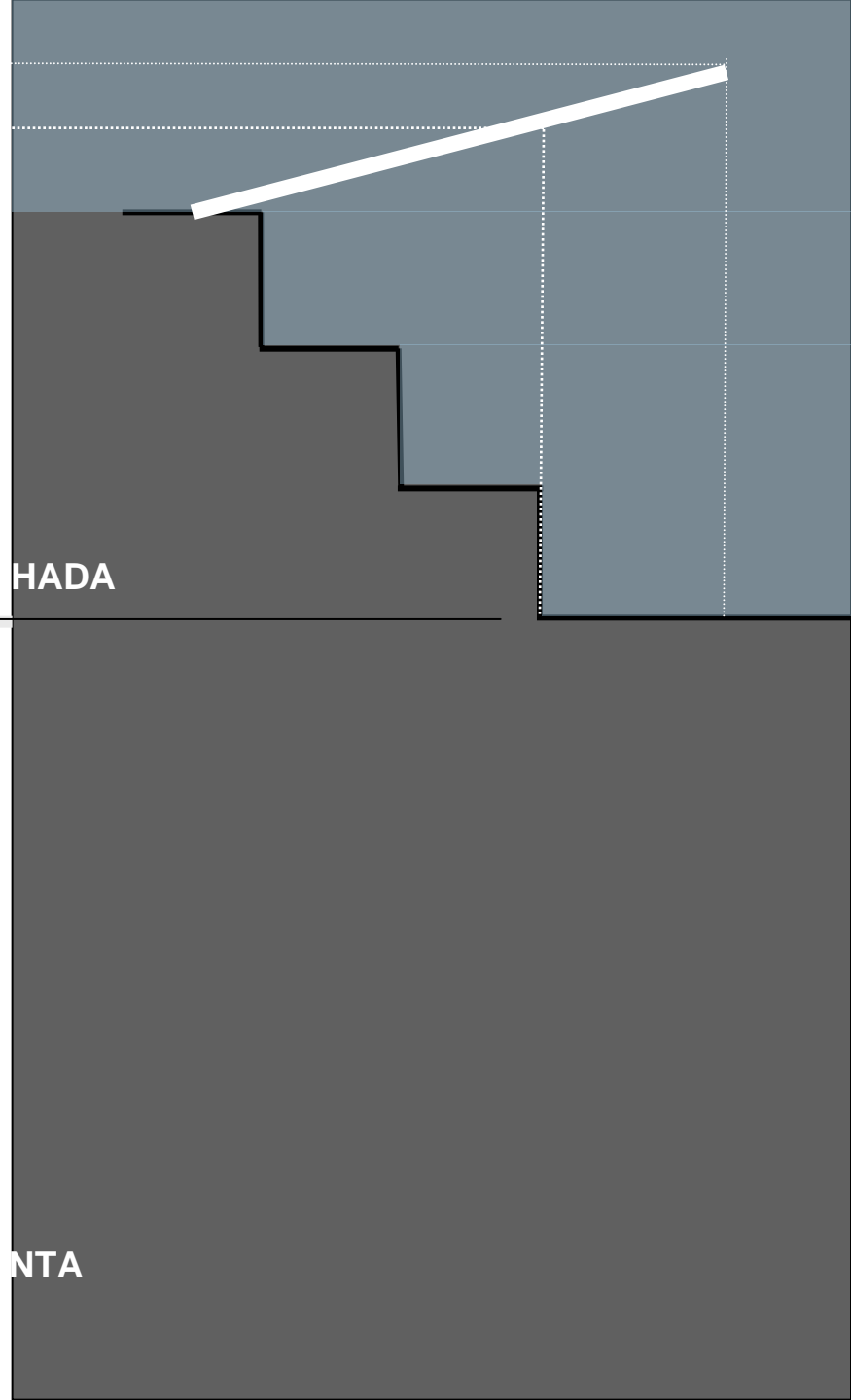
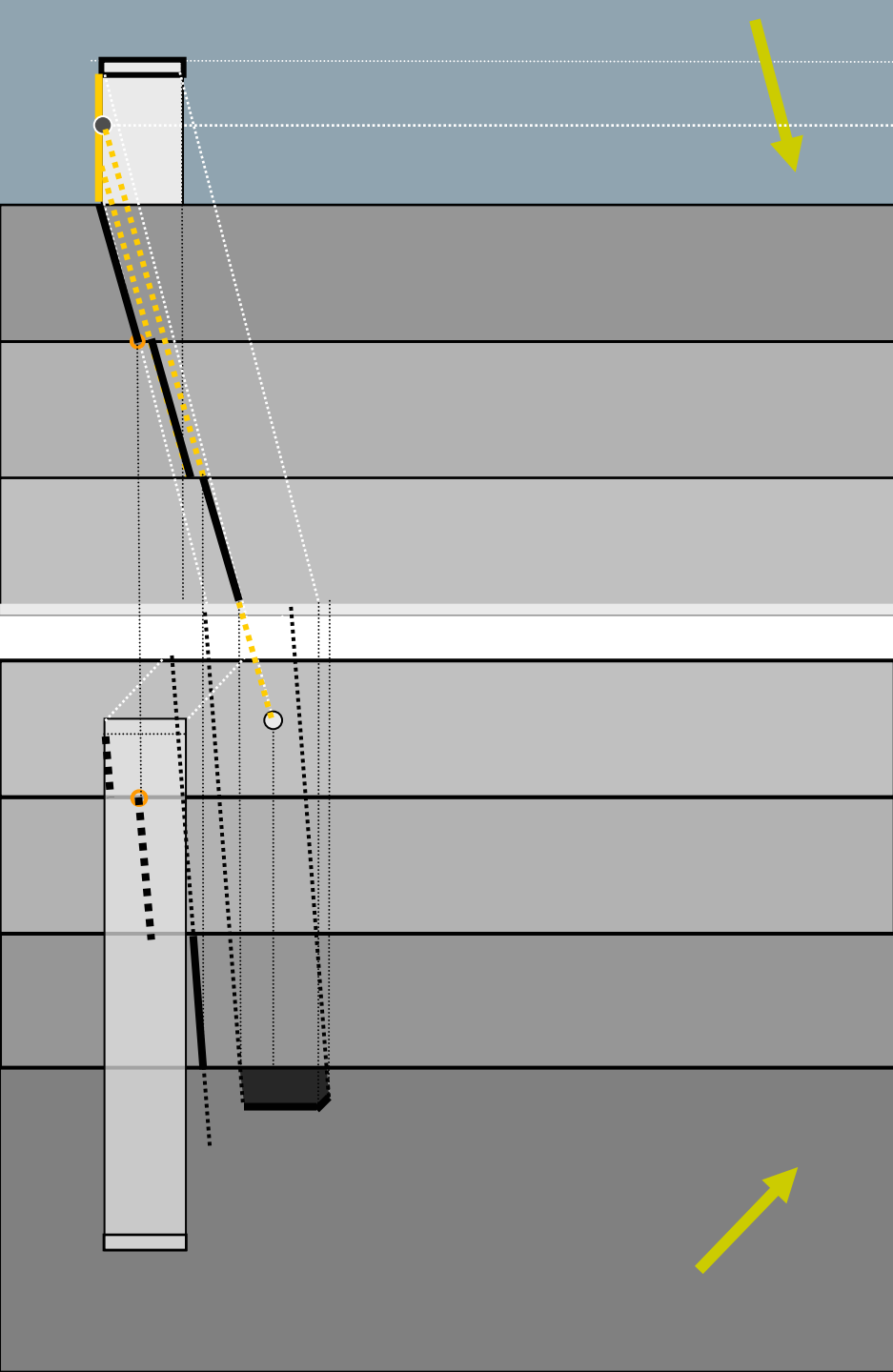

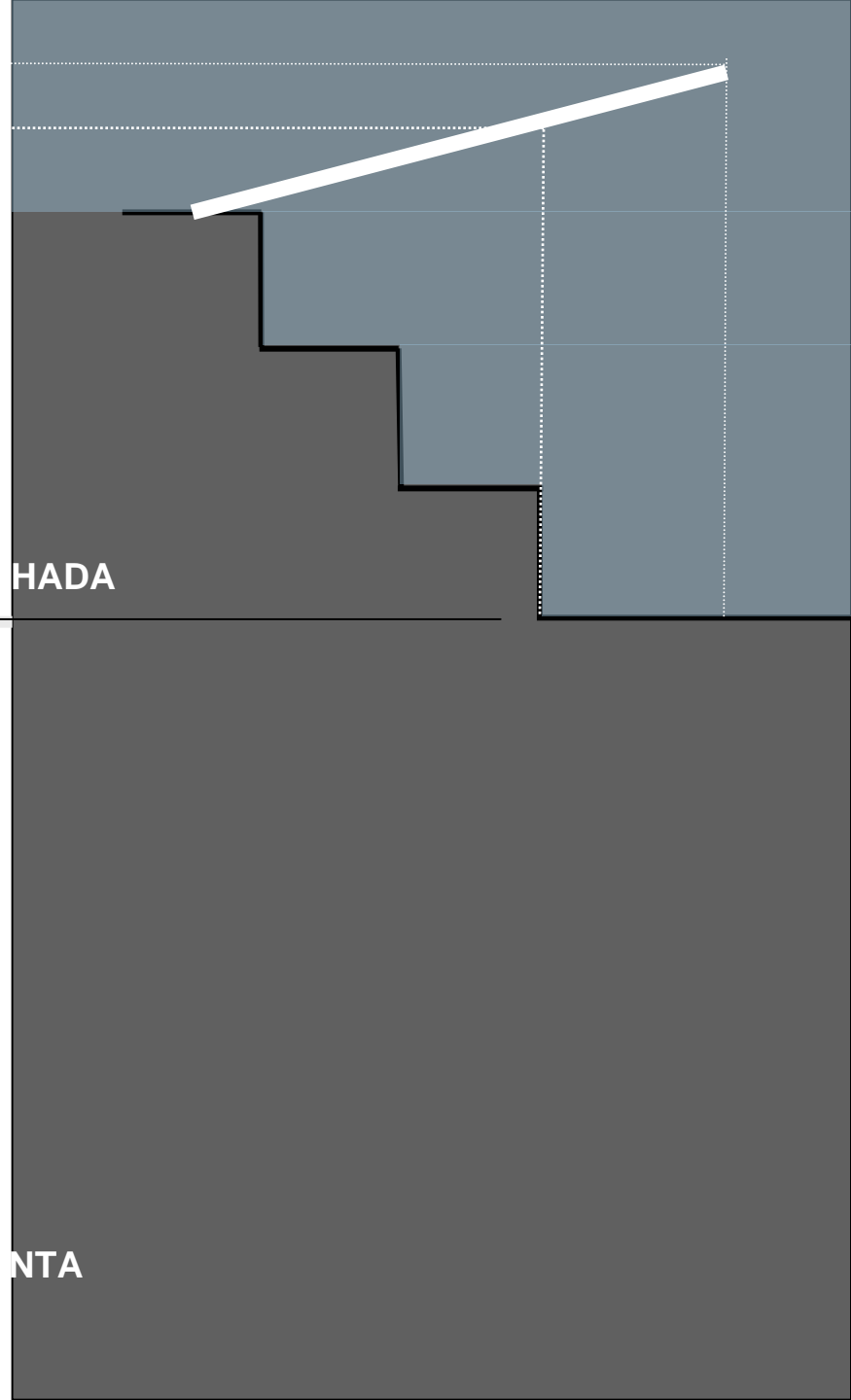
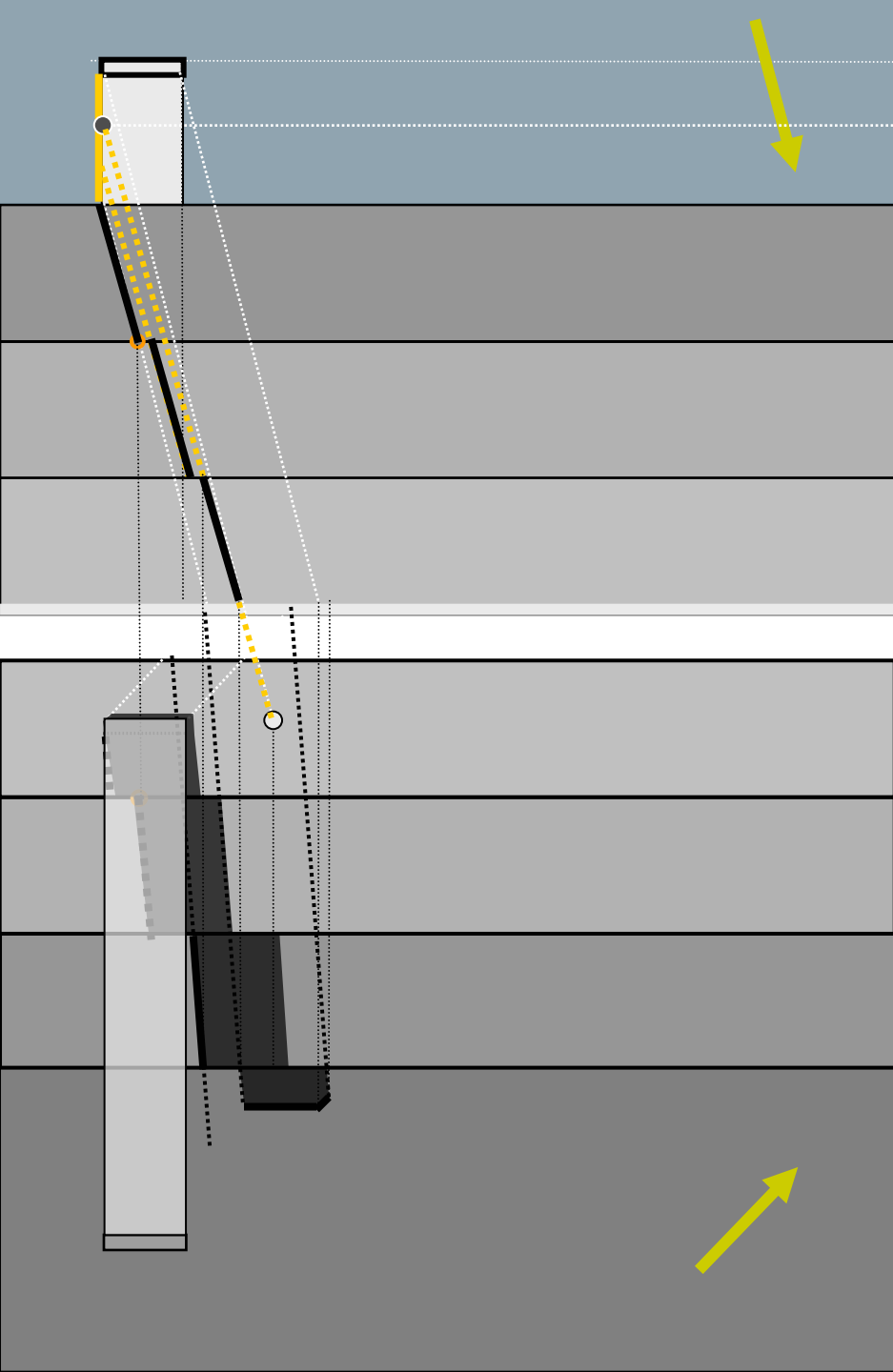

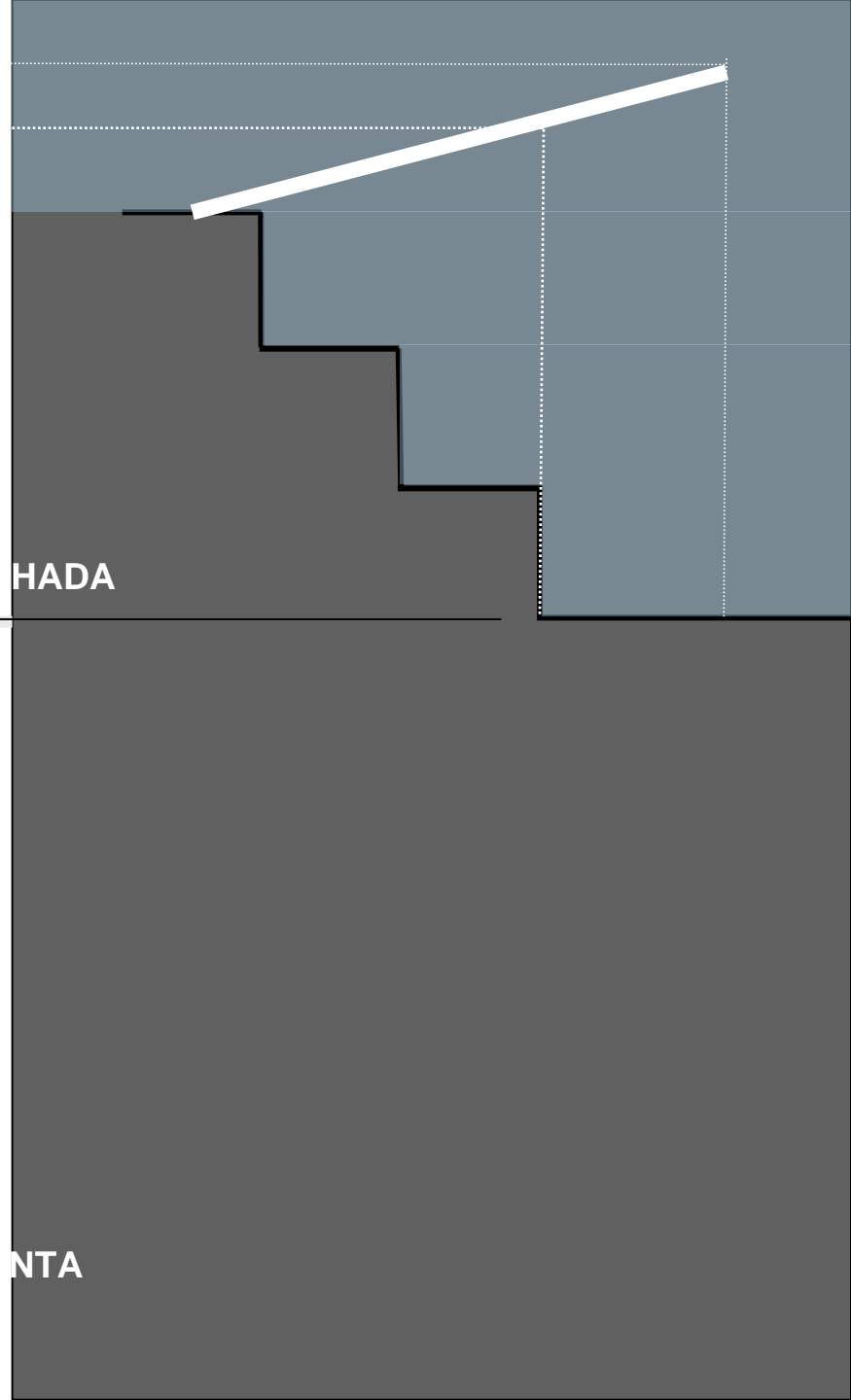
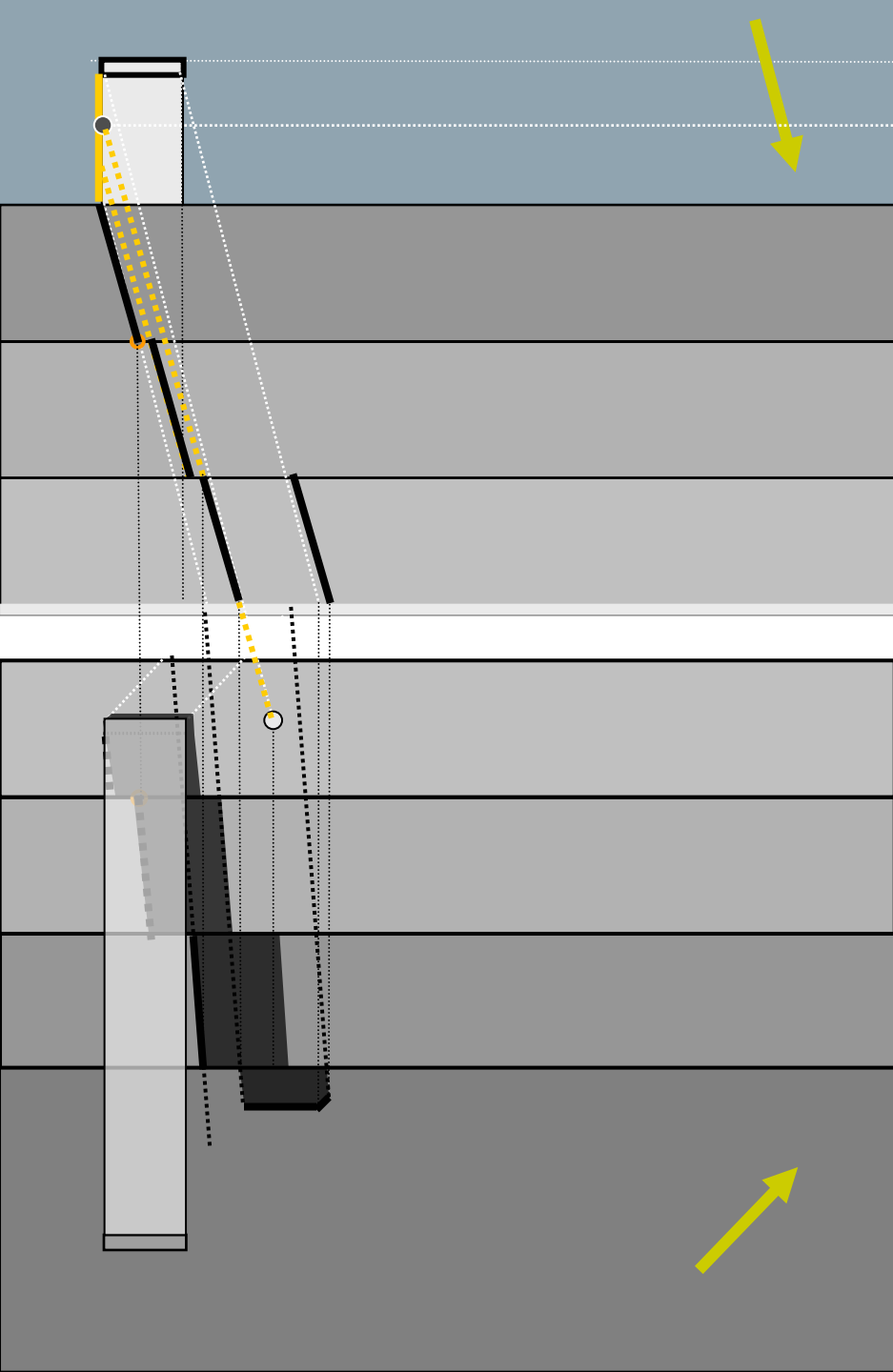

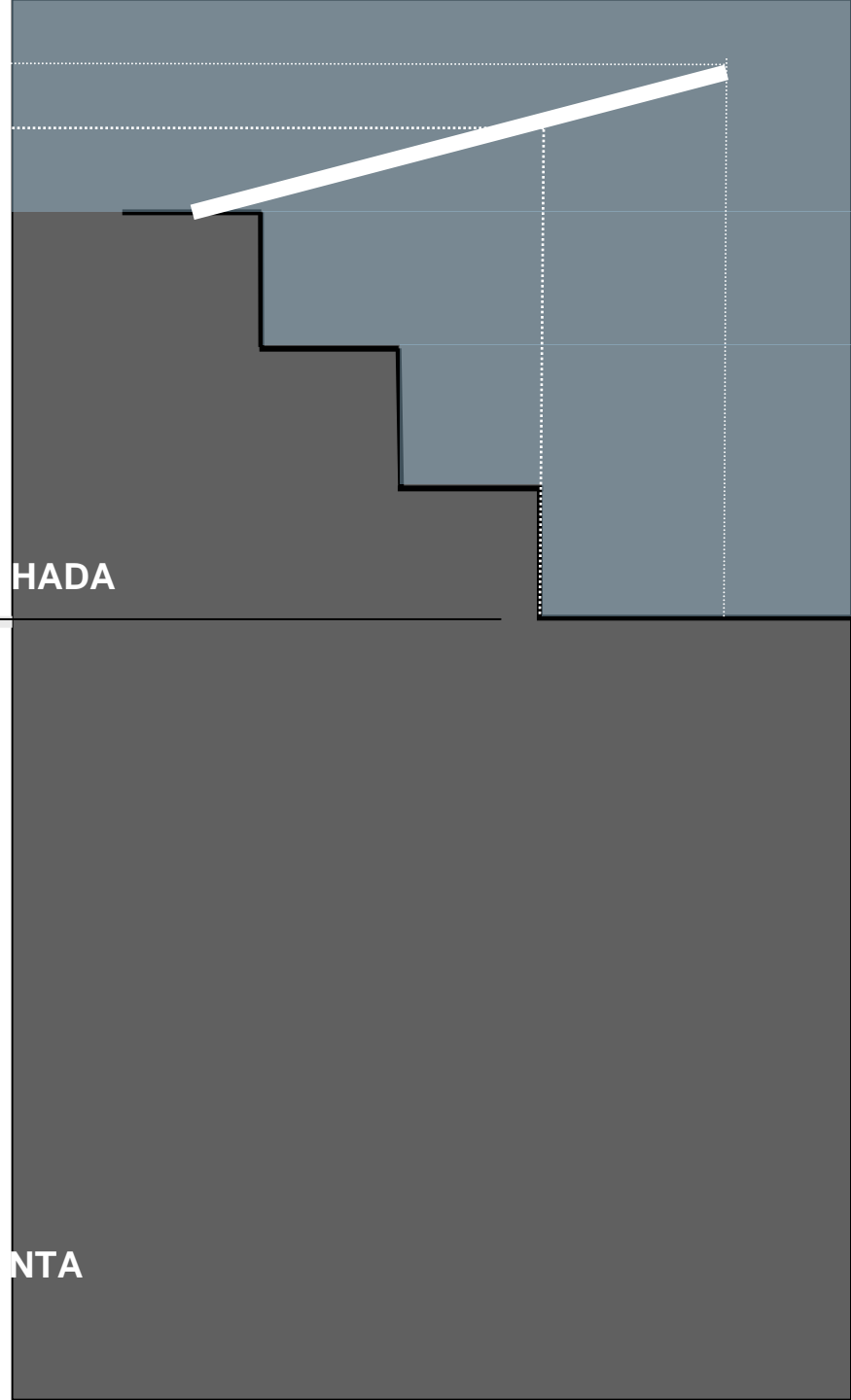
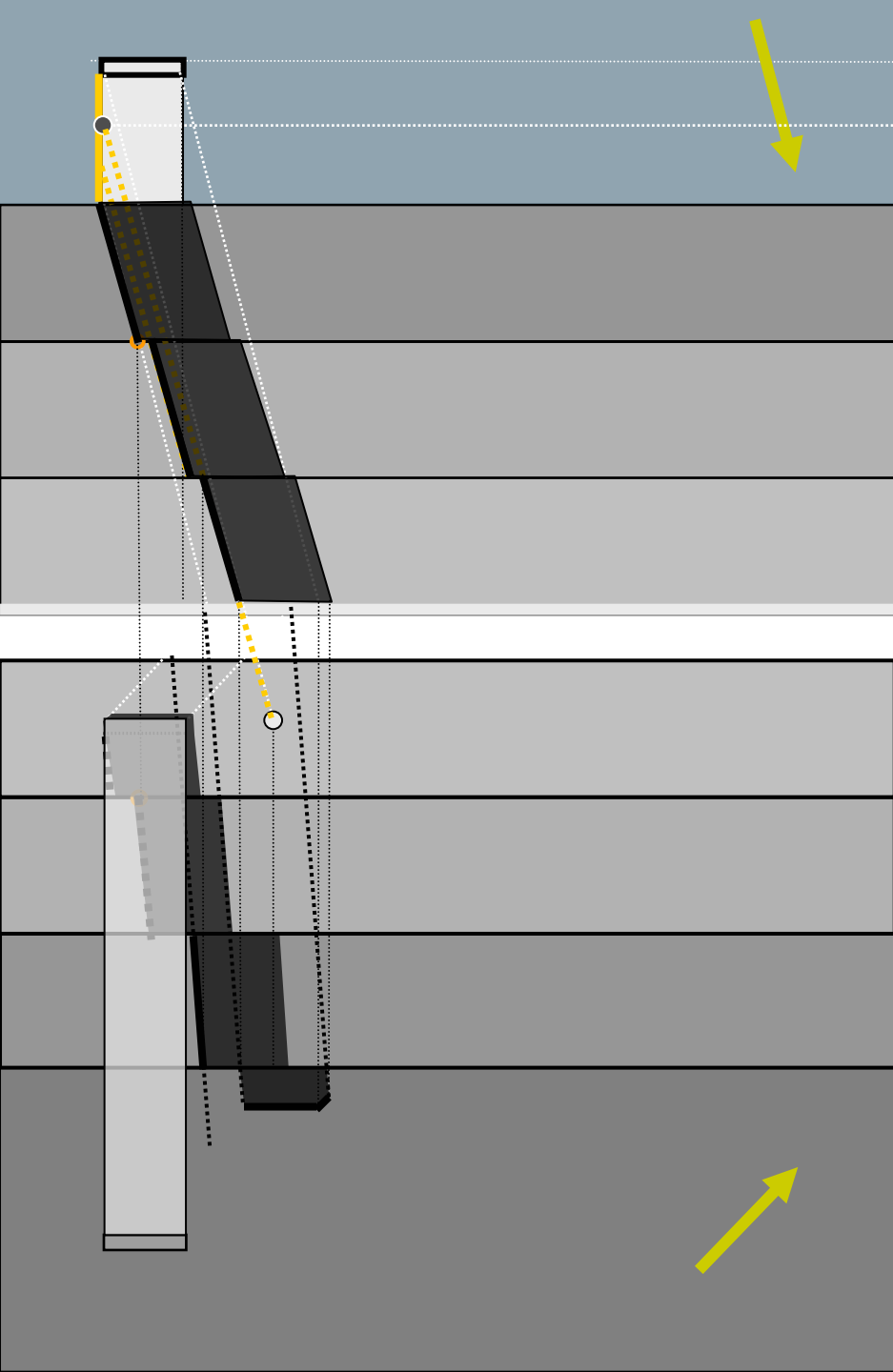

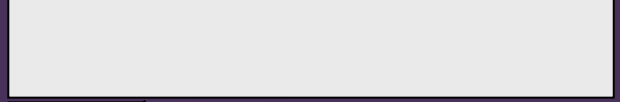
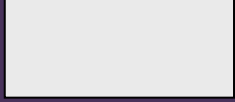
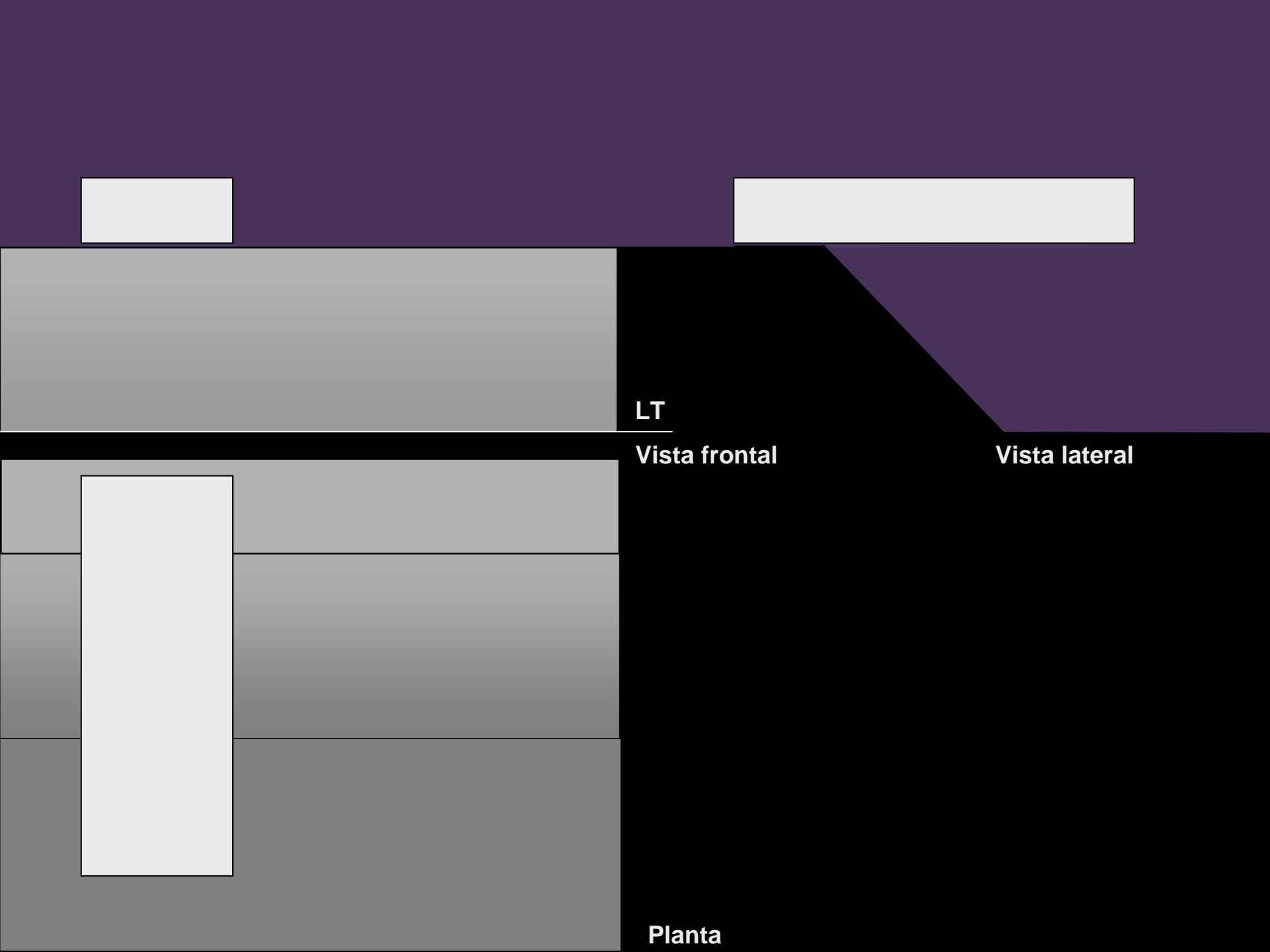

LT

Vista frontal

Vista lateral

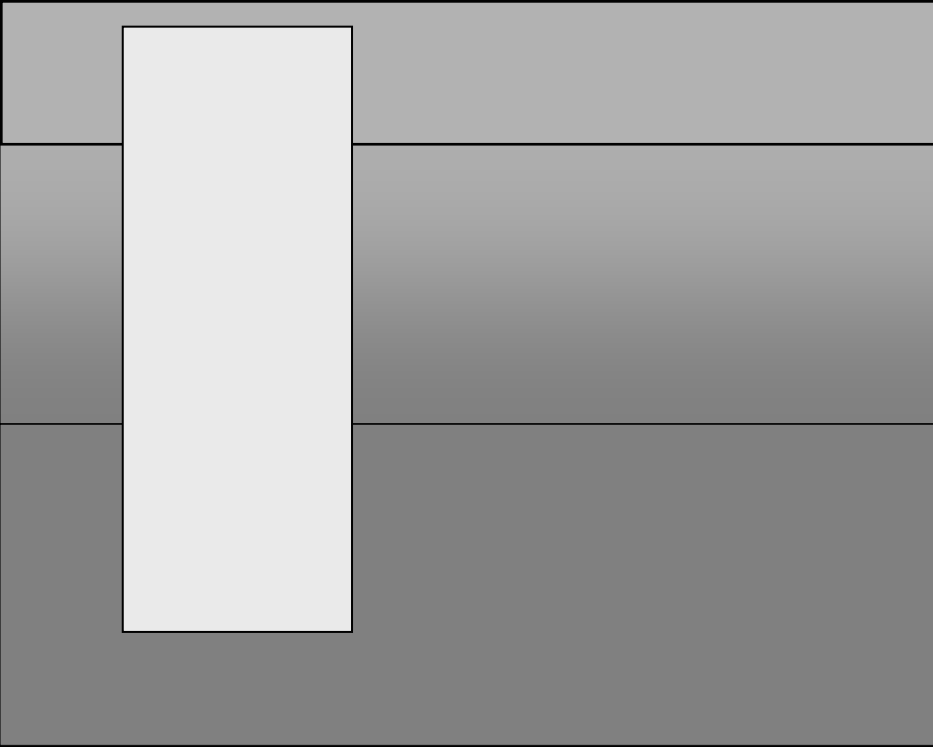

Planta

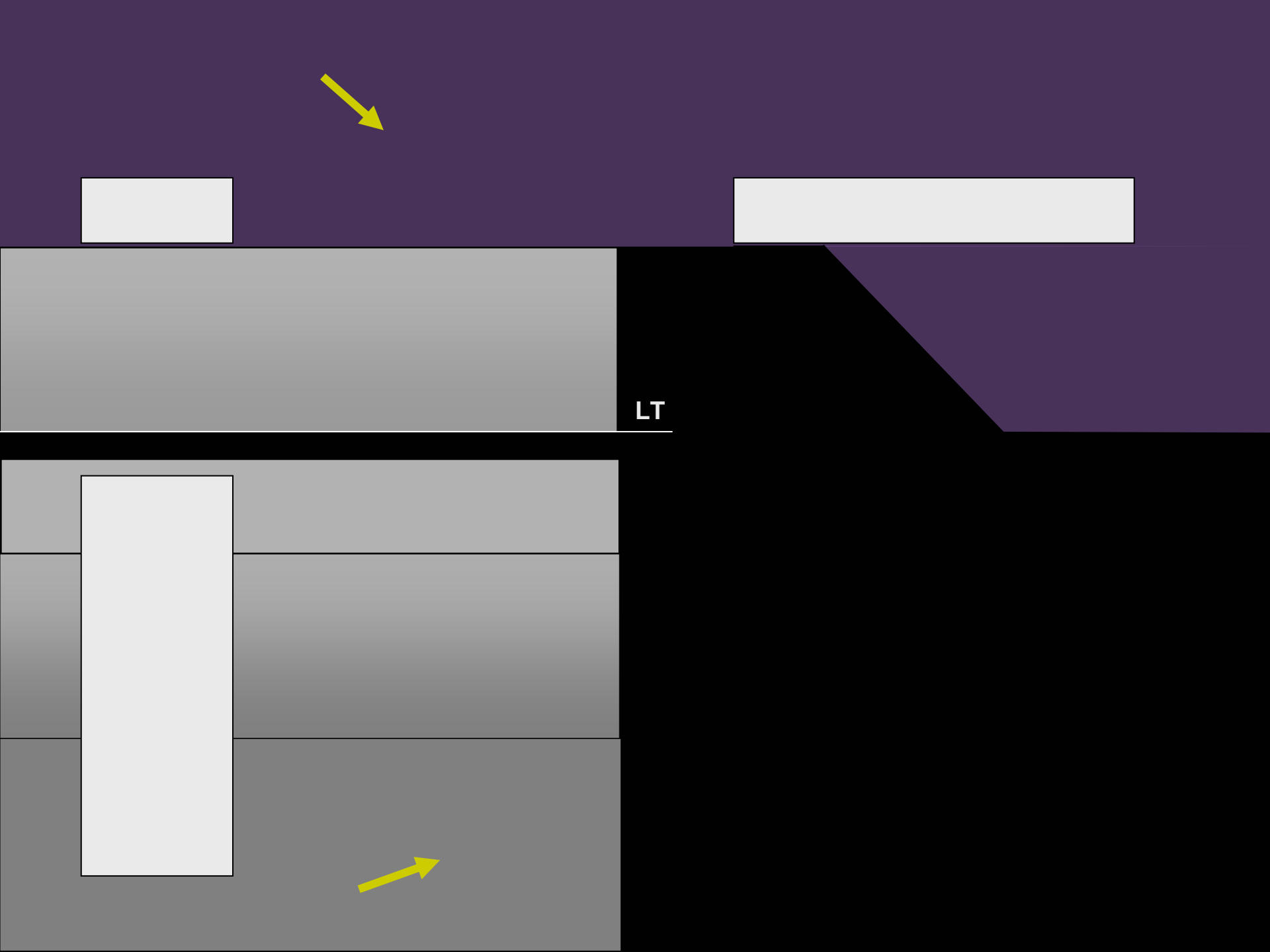

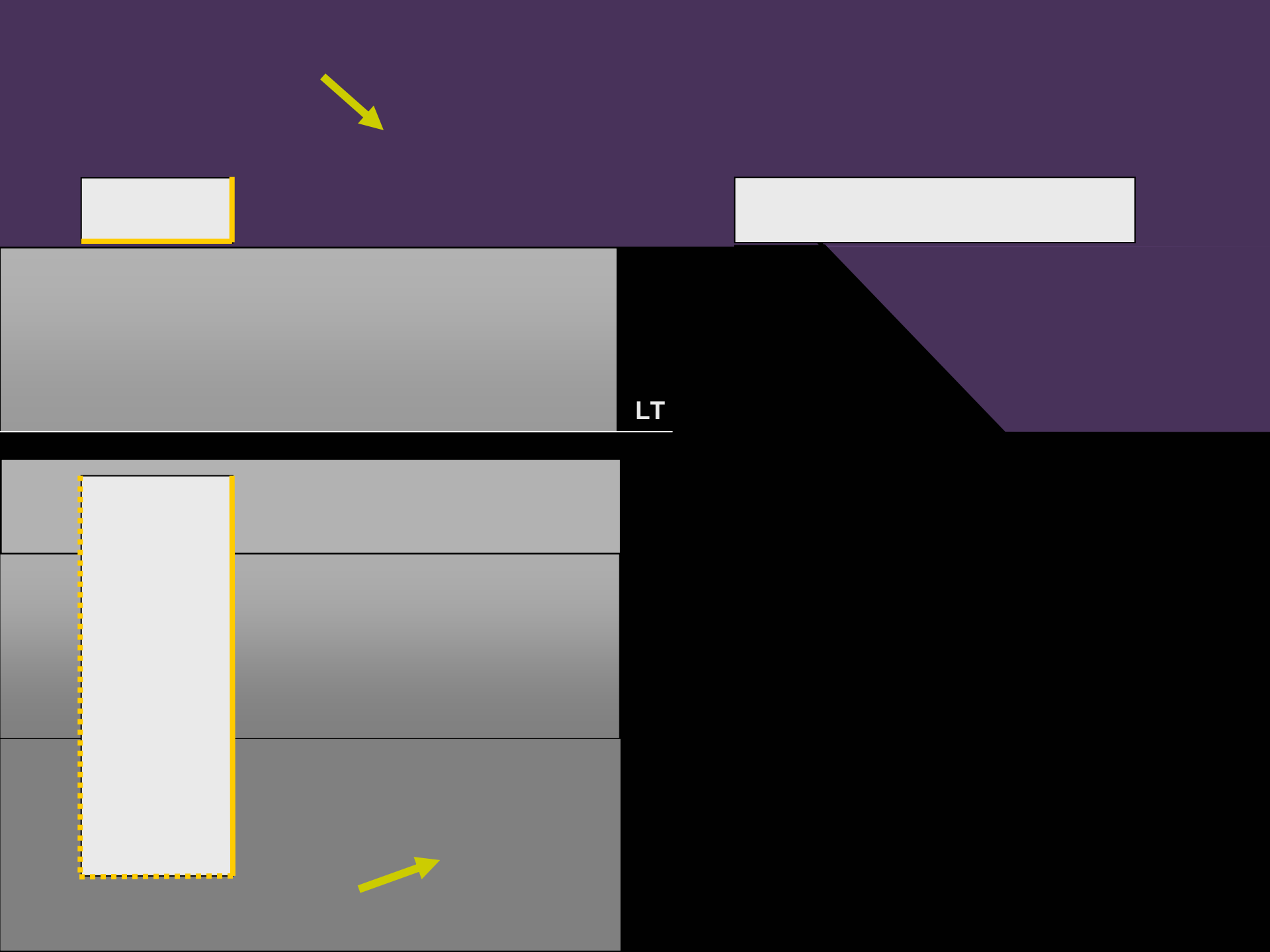

LT

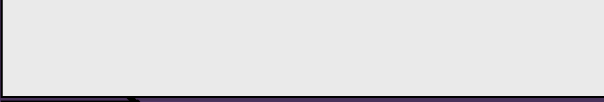
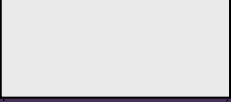
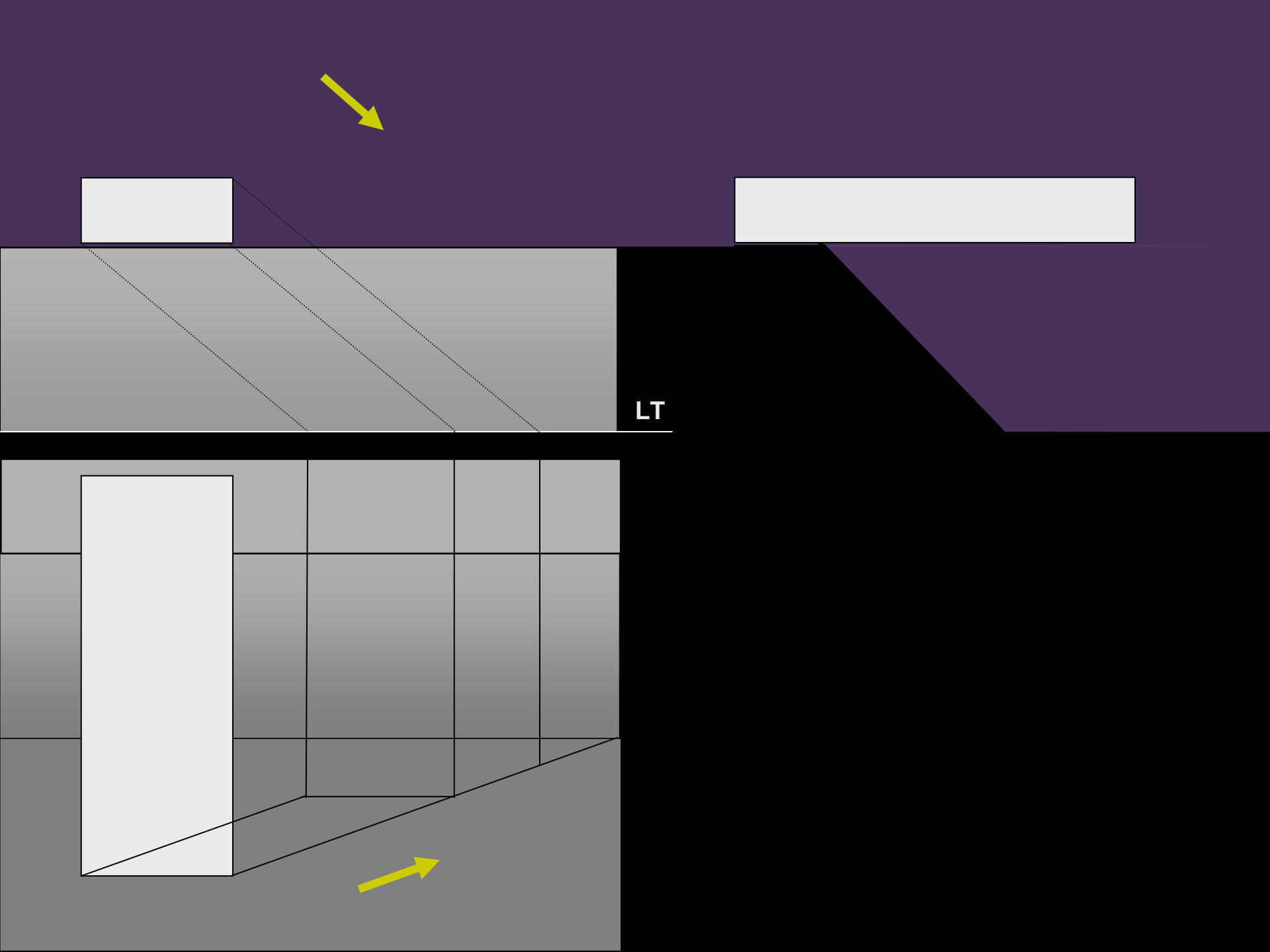

LT

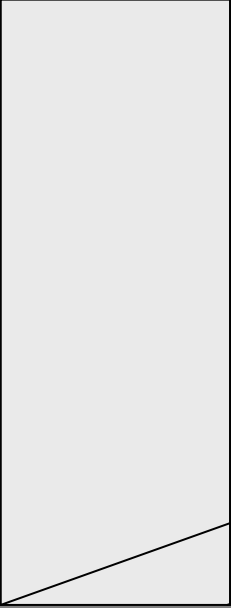

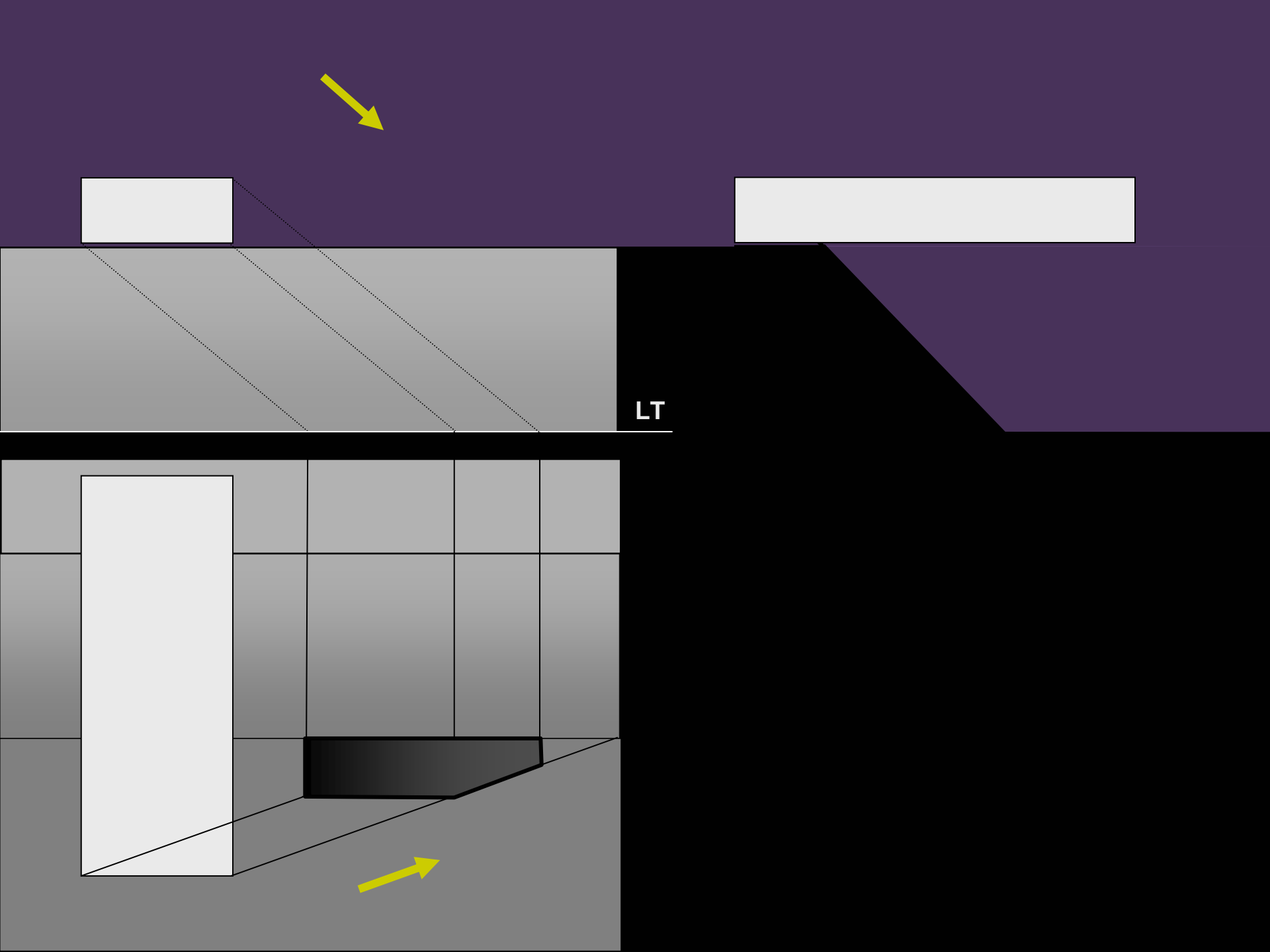

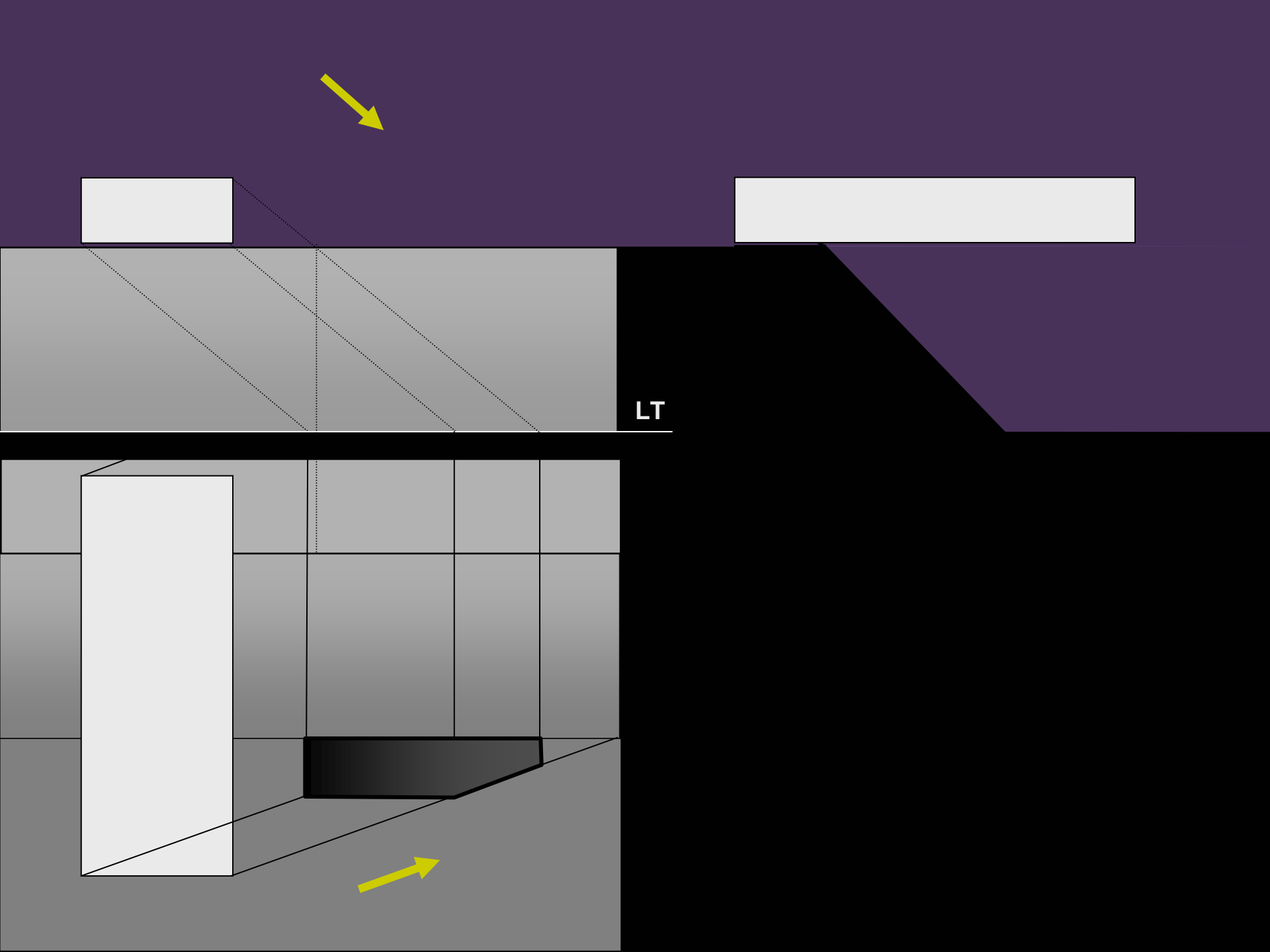

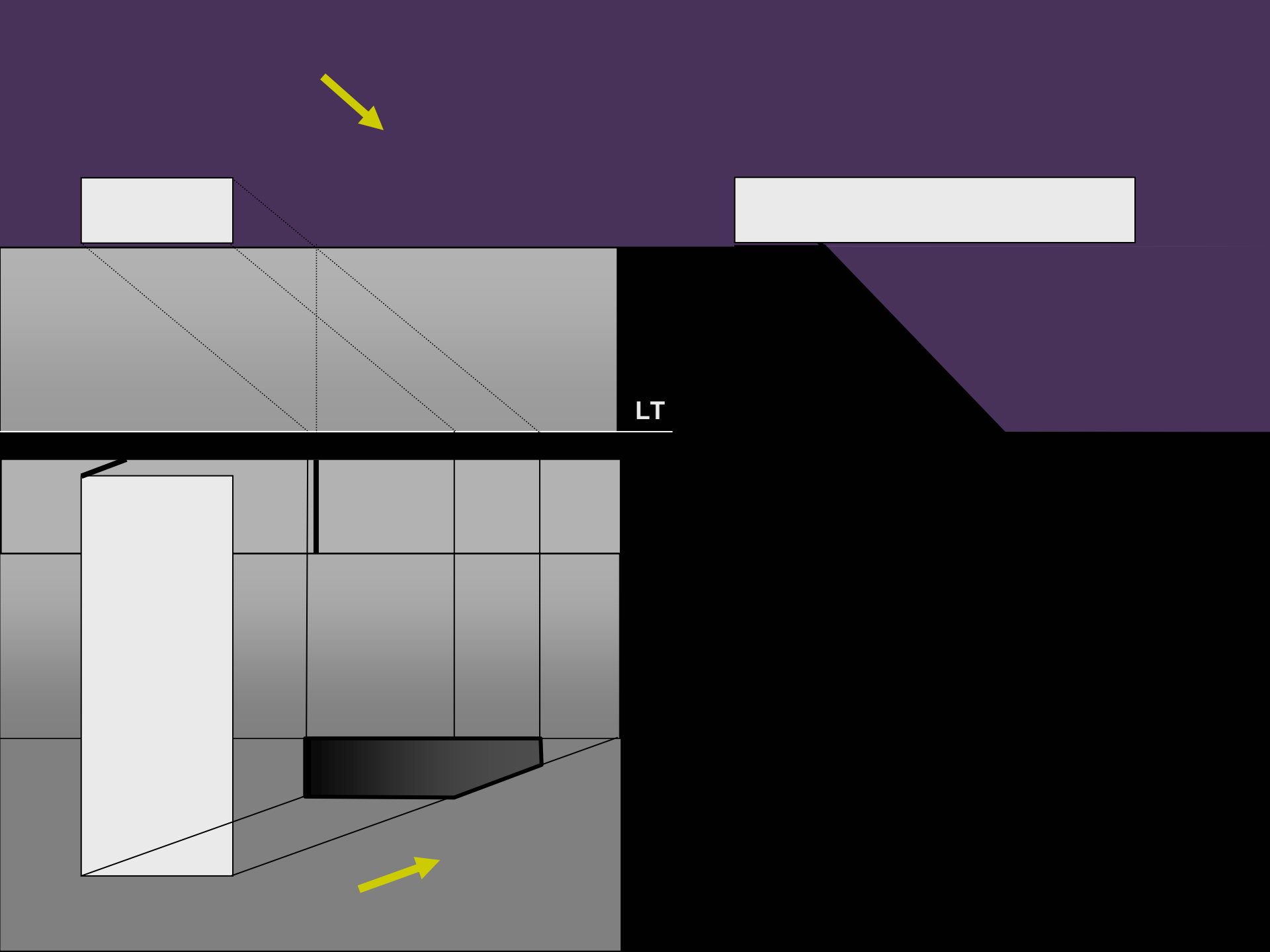

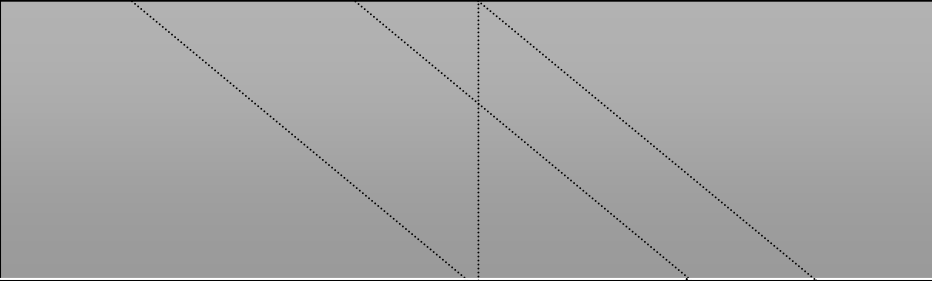
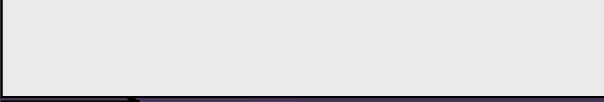
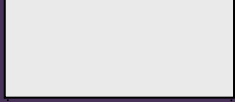
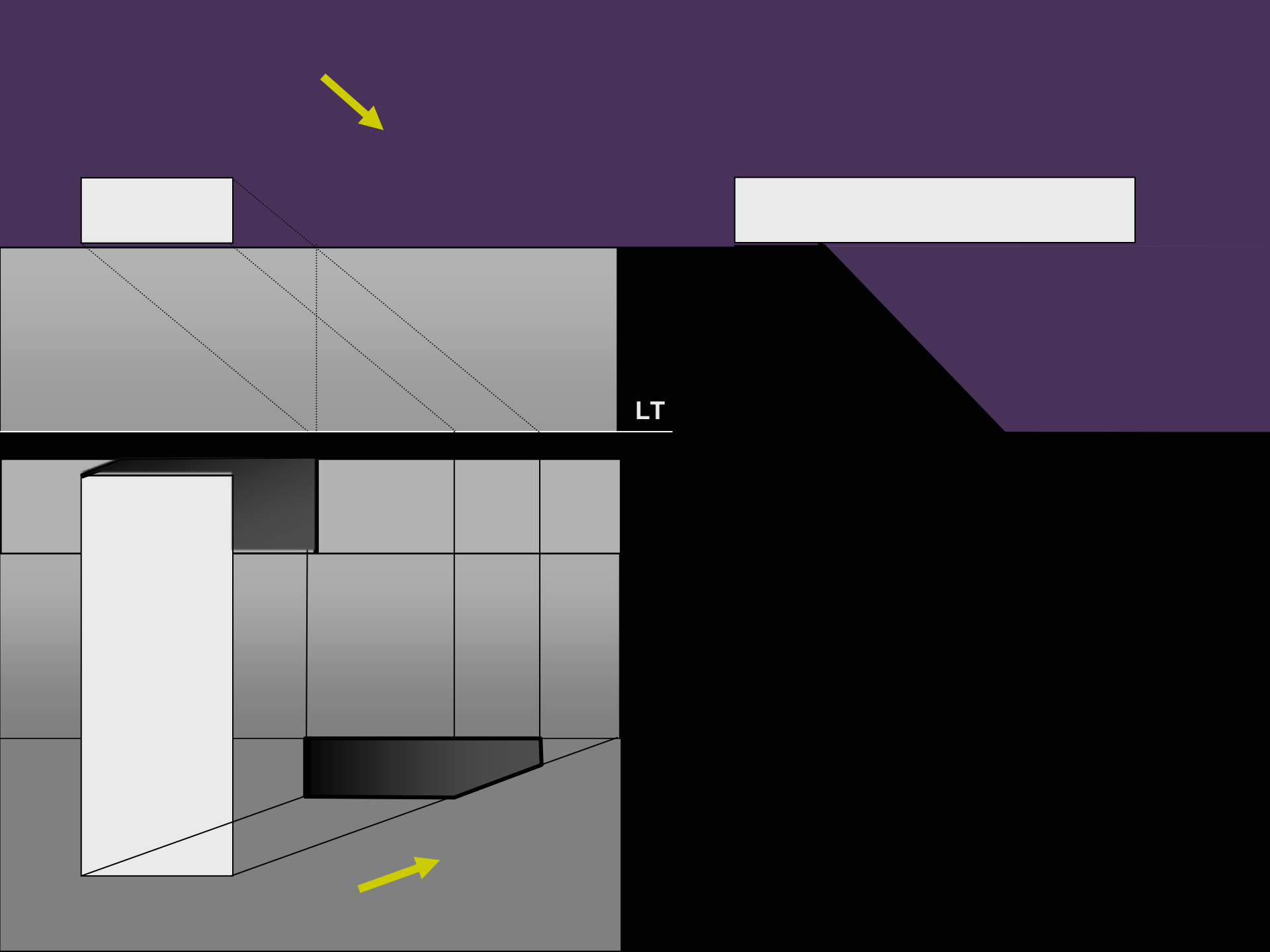

LT

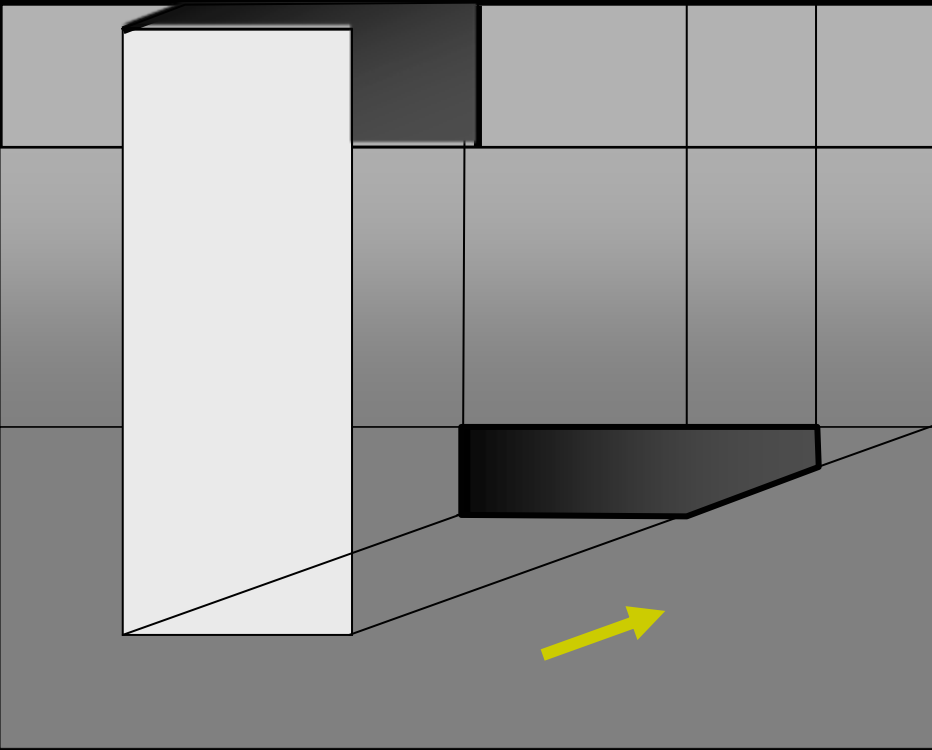

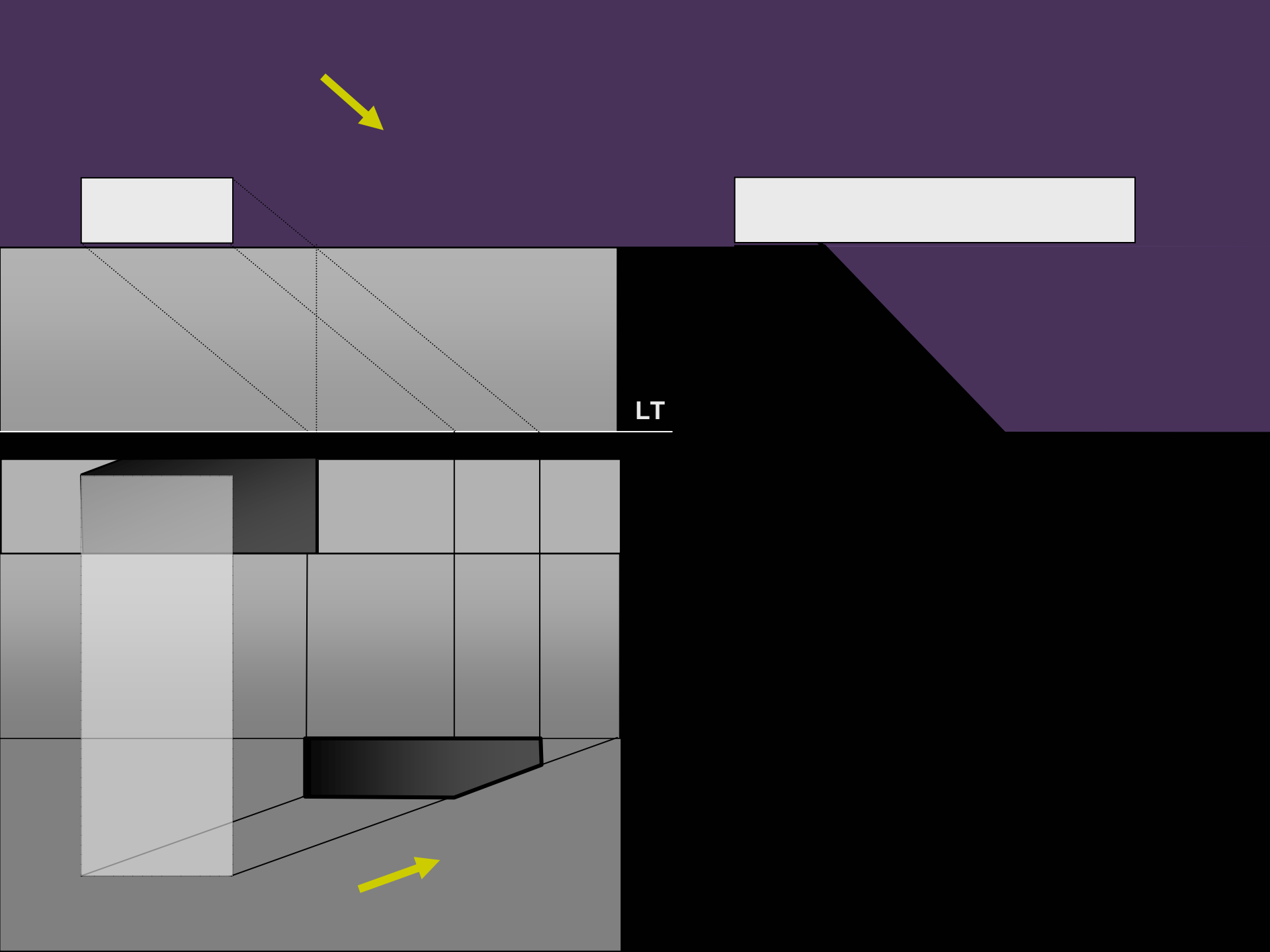

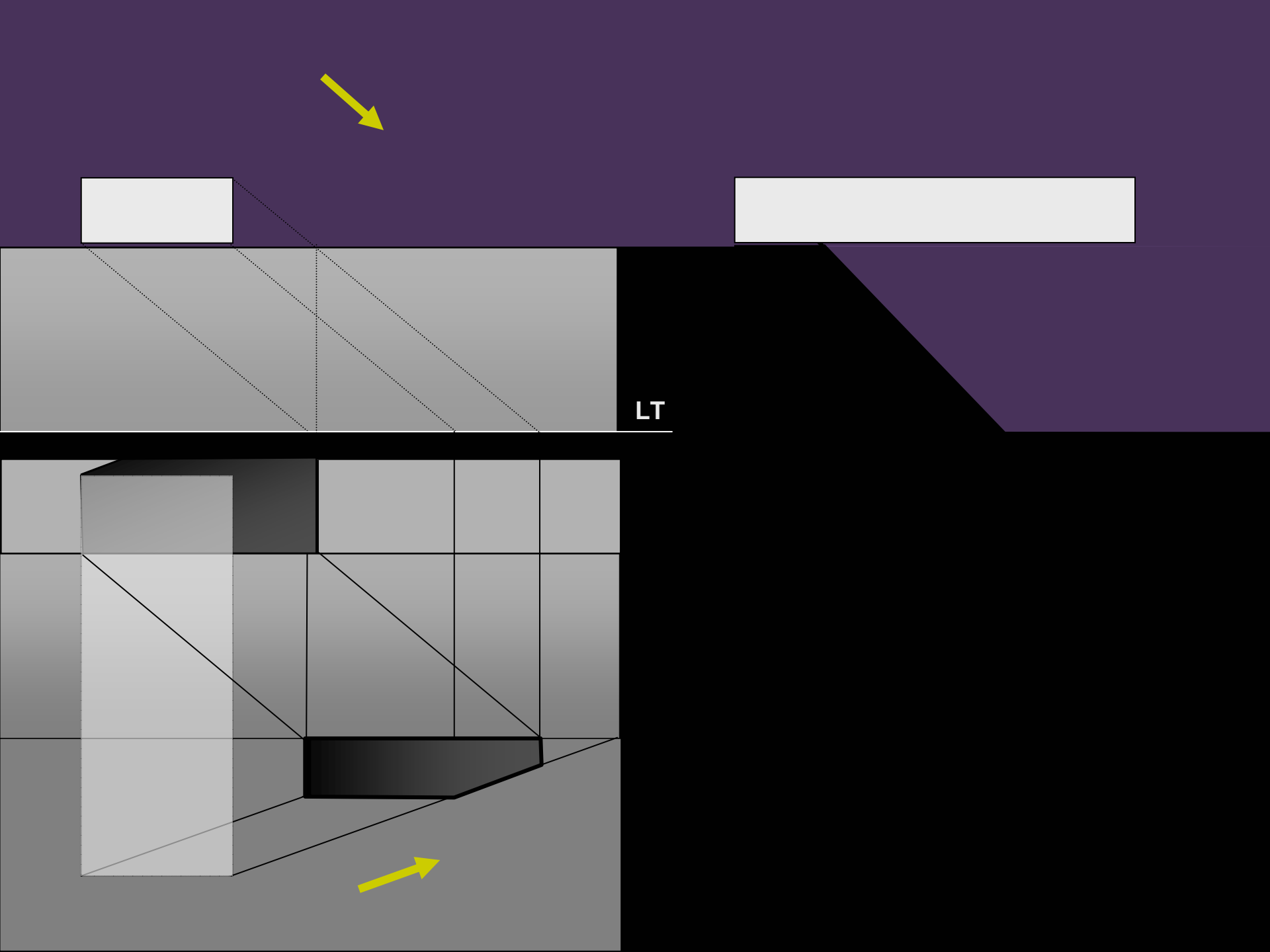

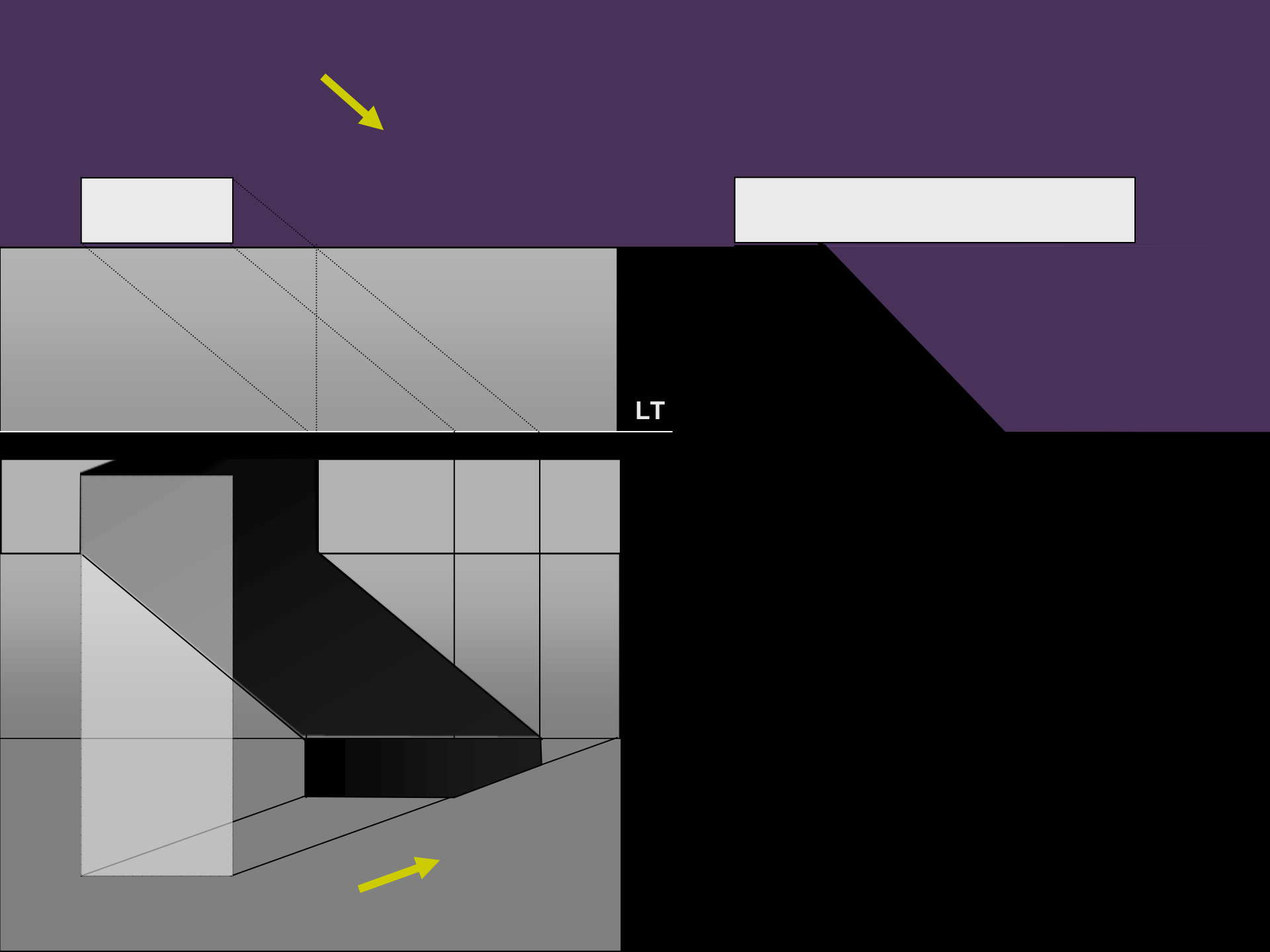

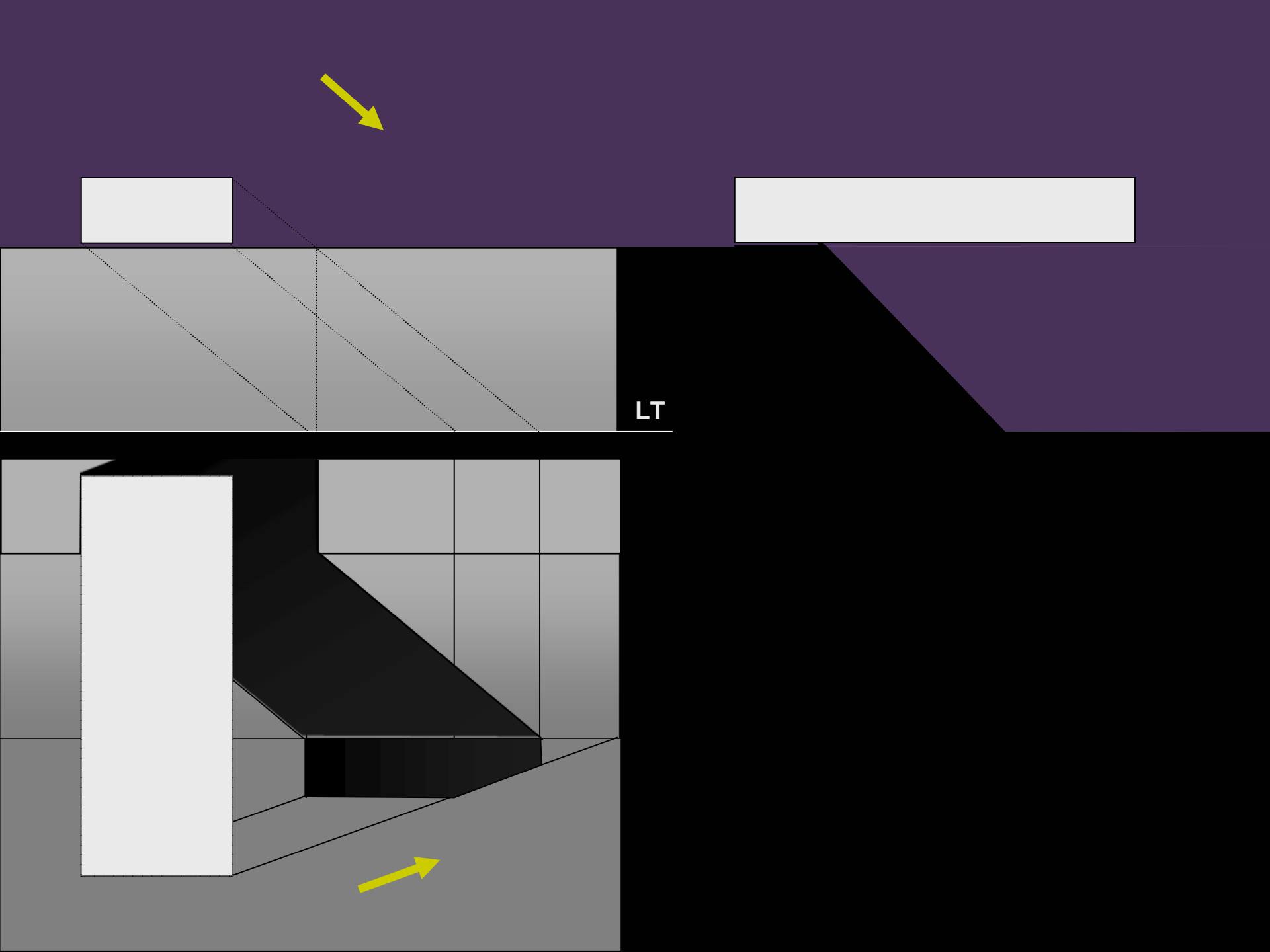

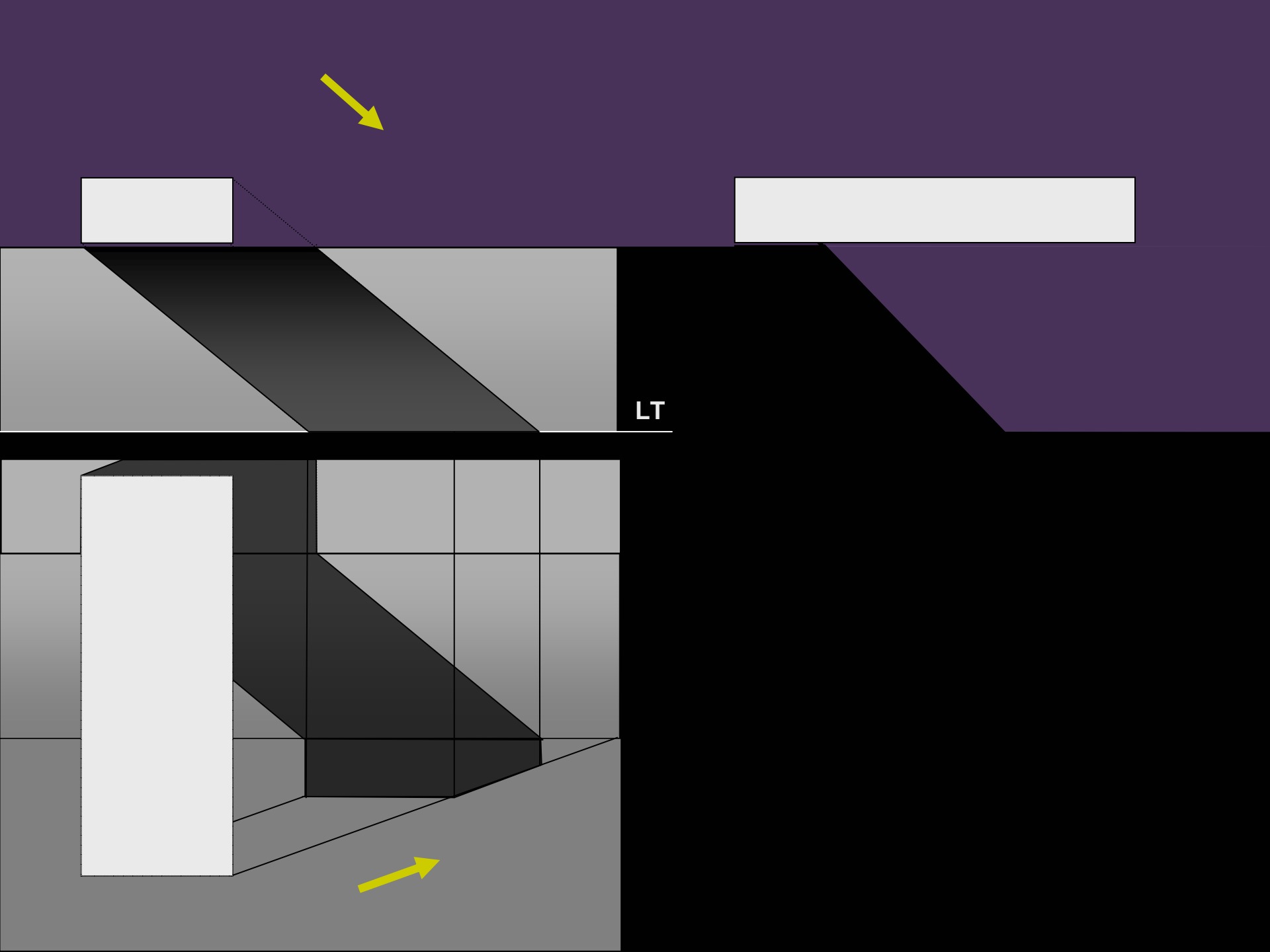

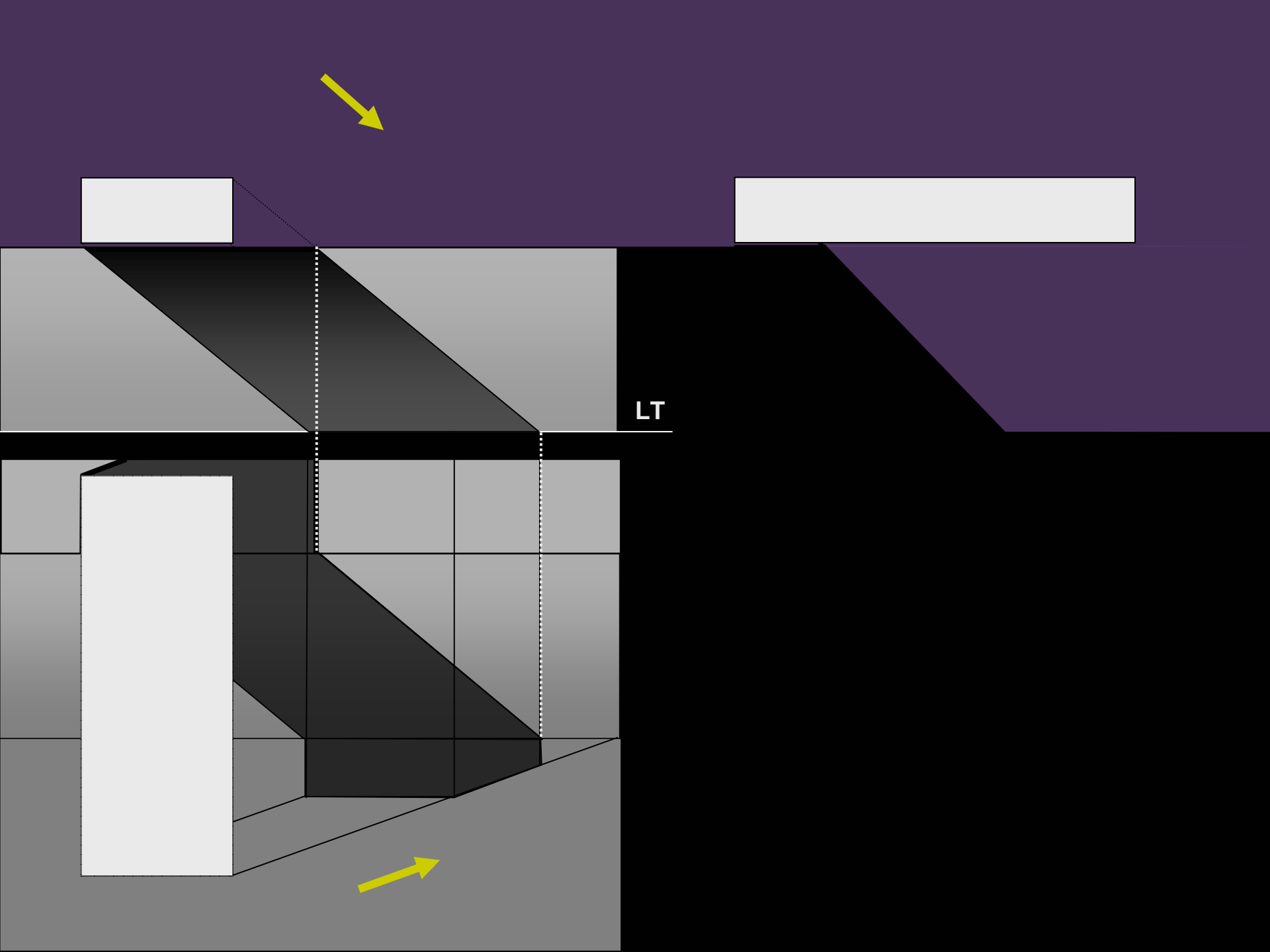

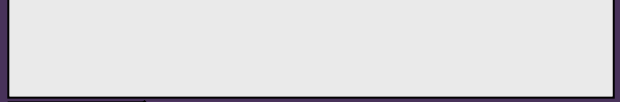
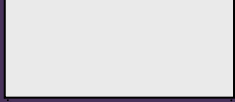
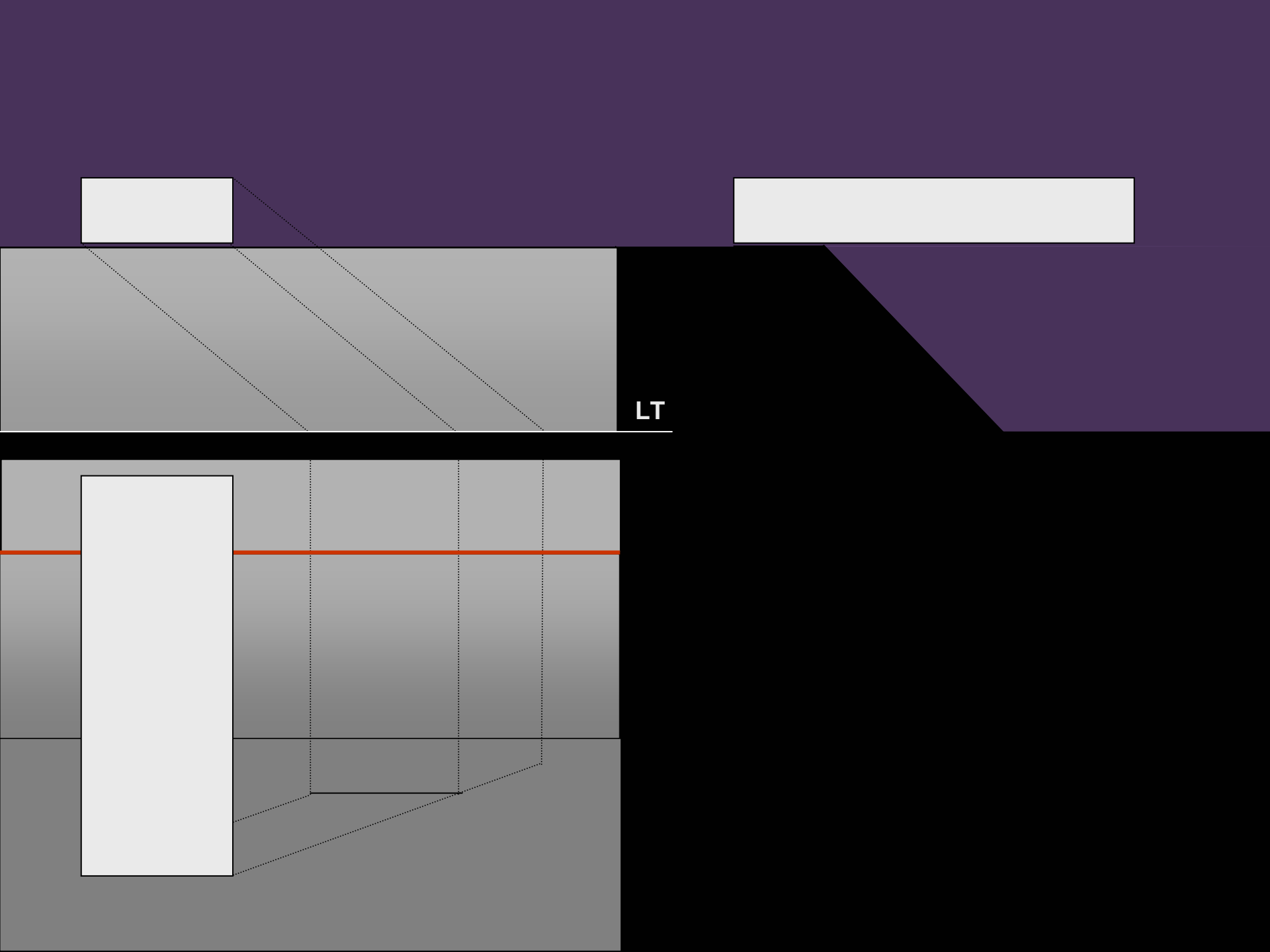

LT

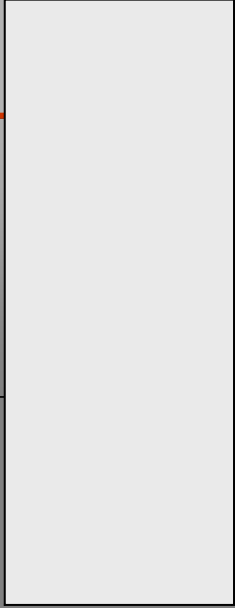

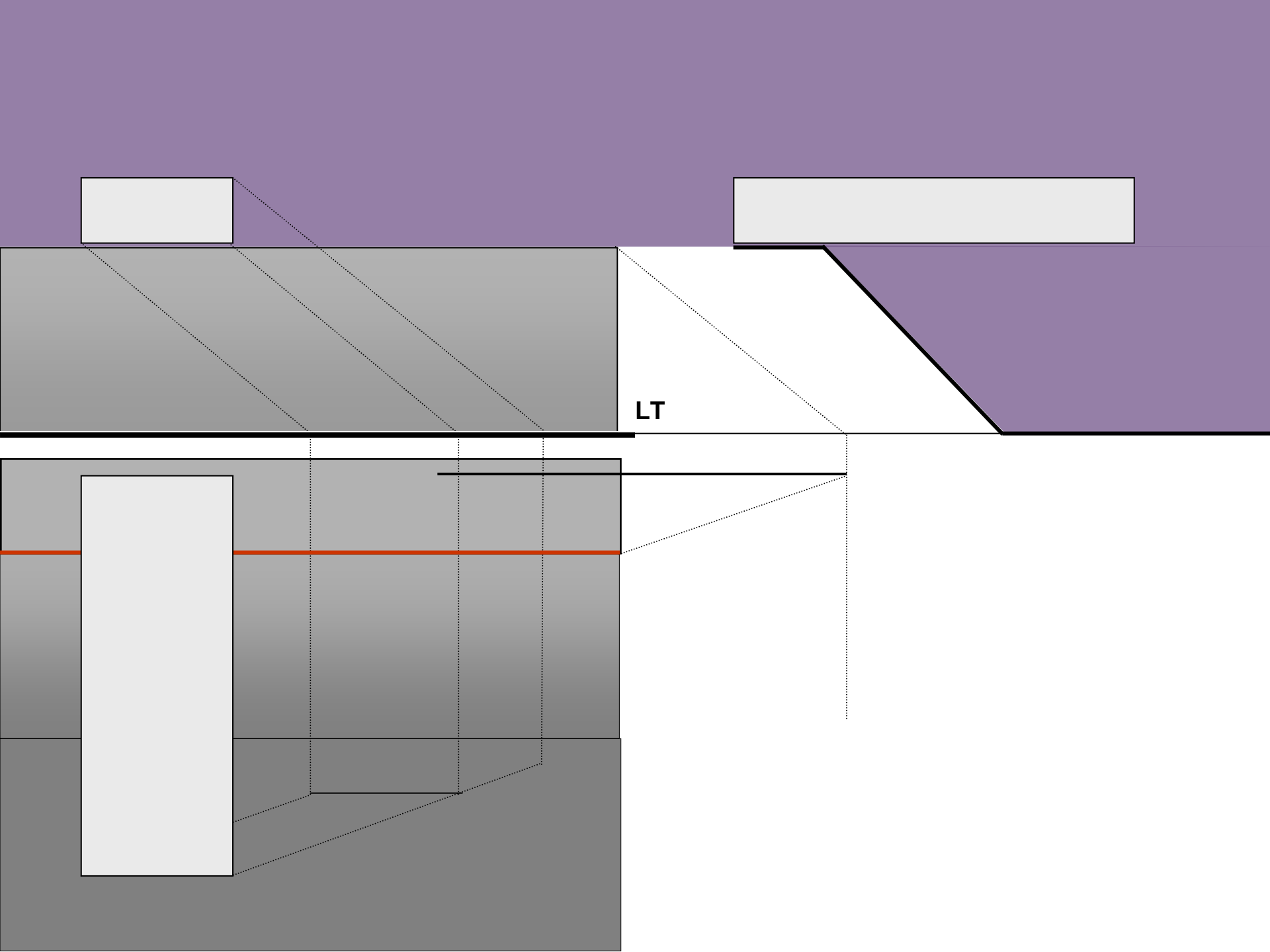

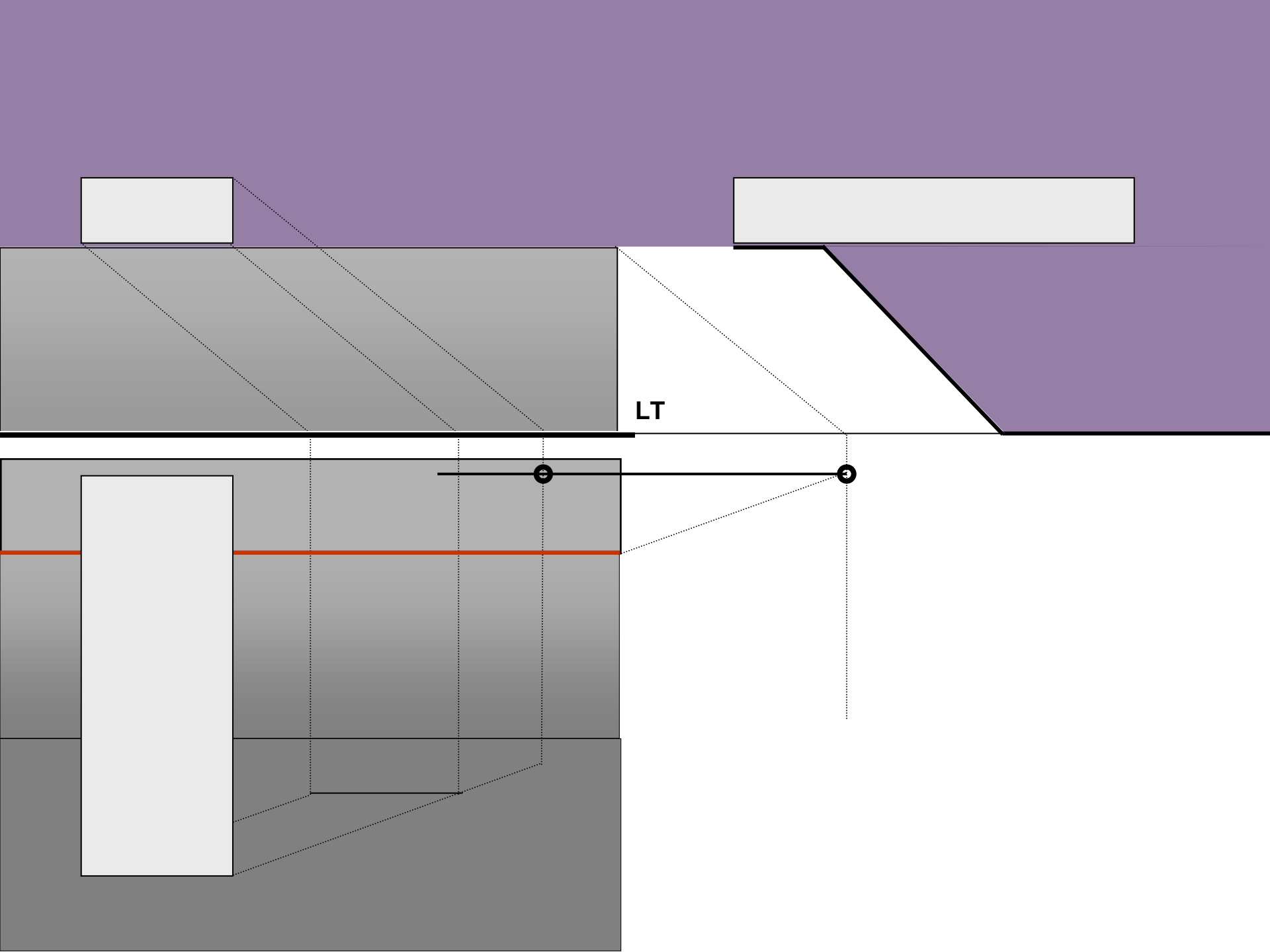

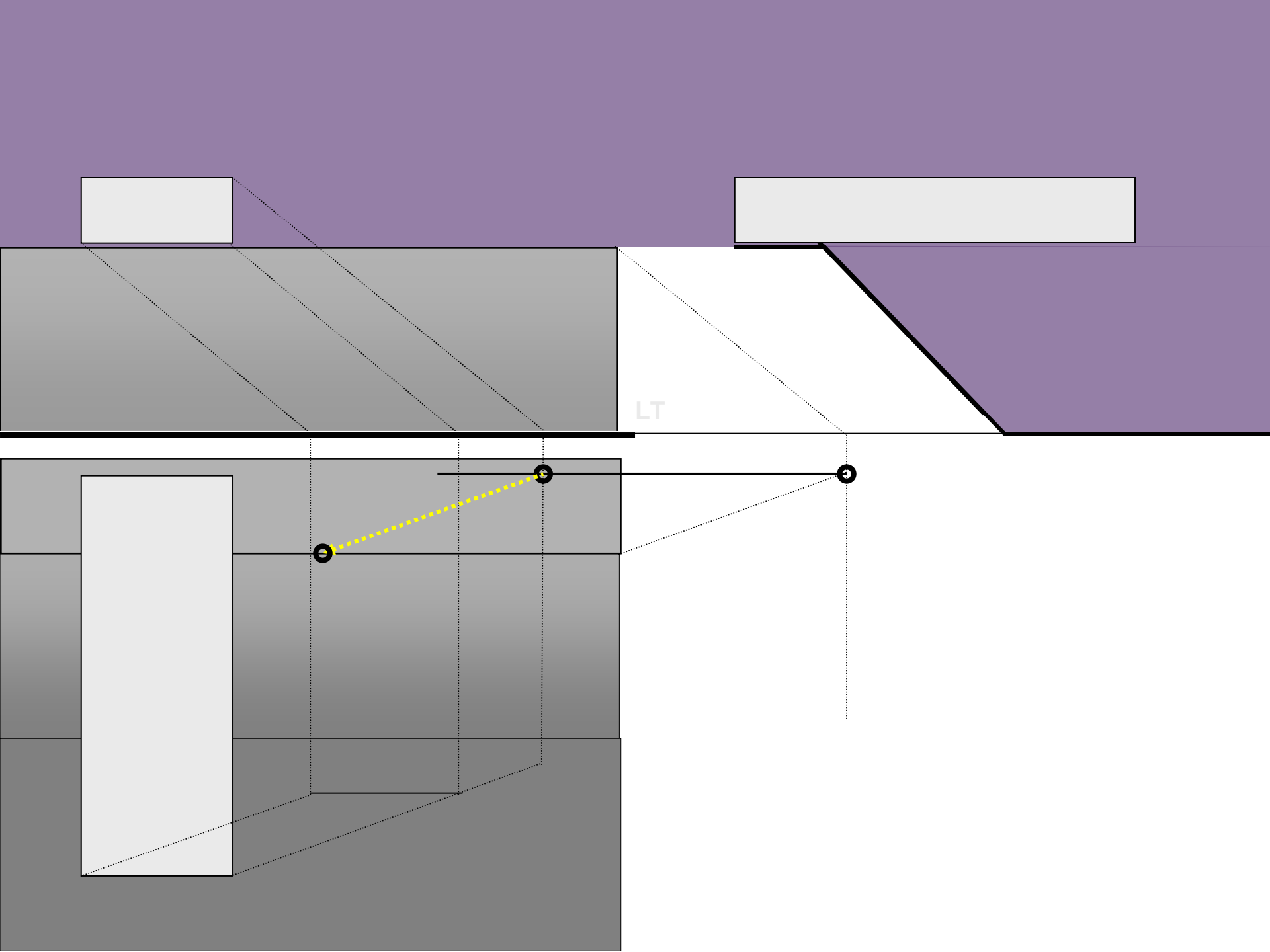

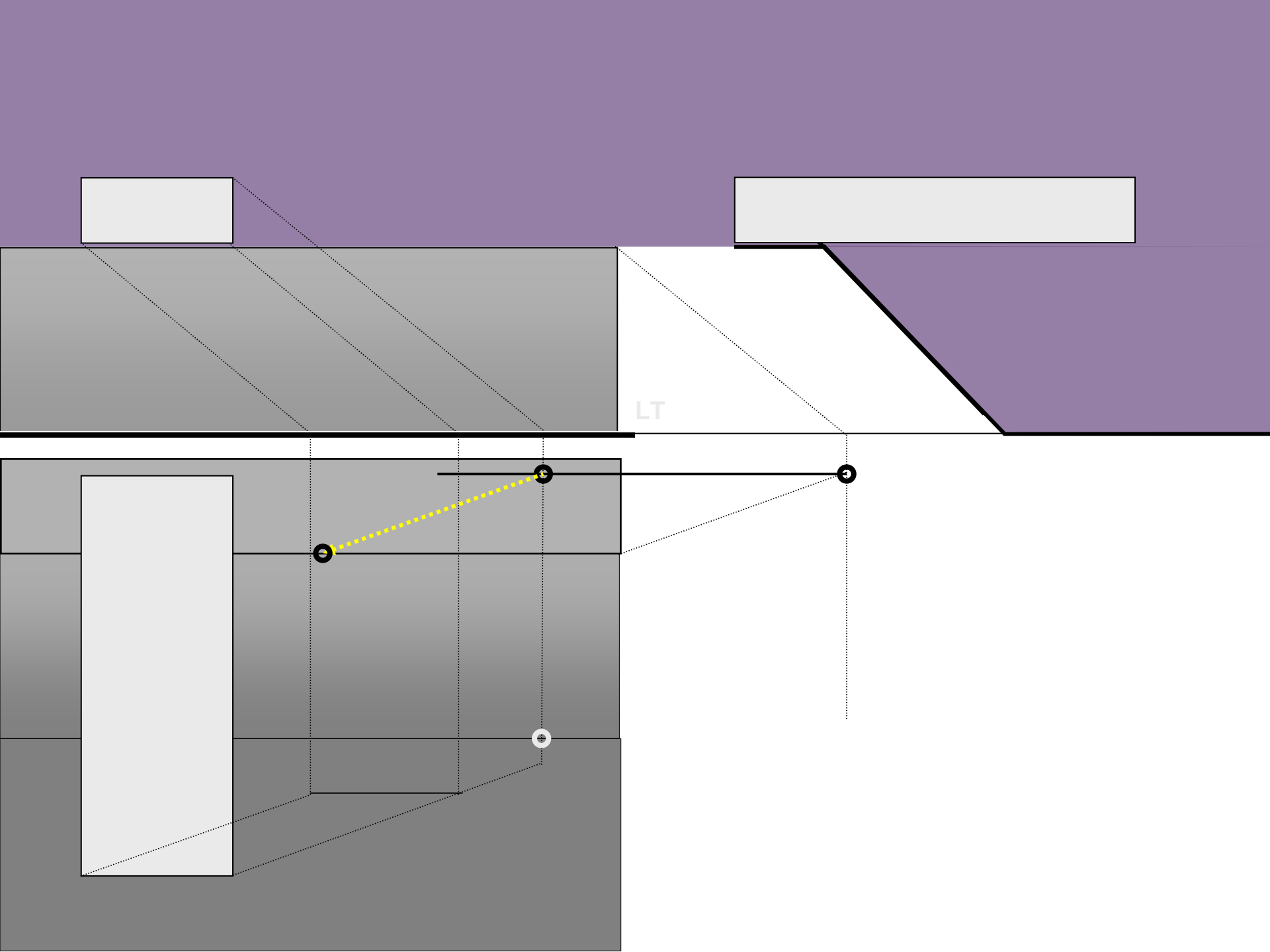

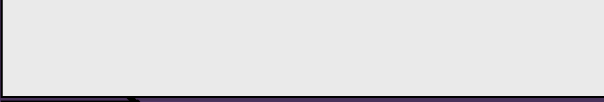
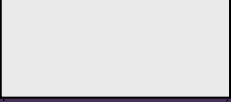
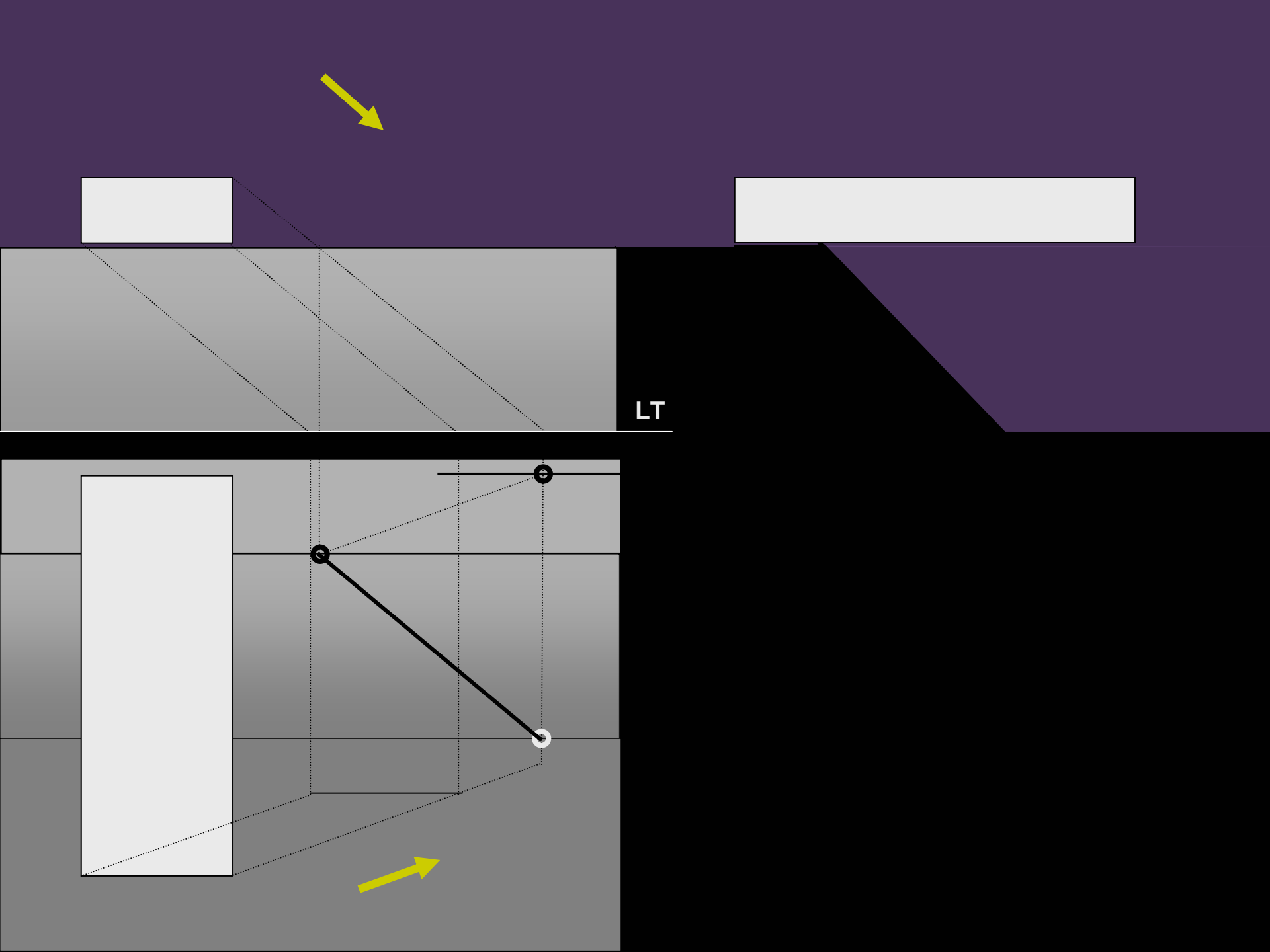

LT

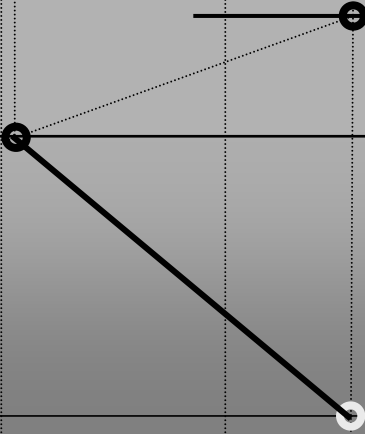
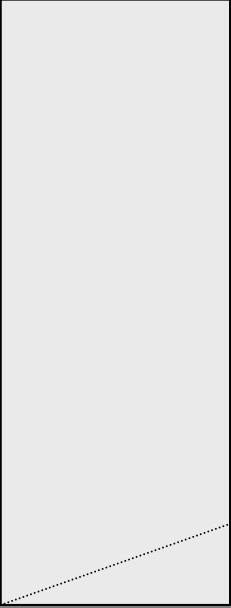

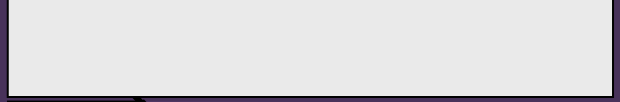
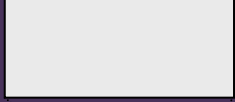
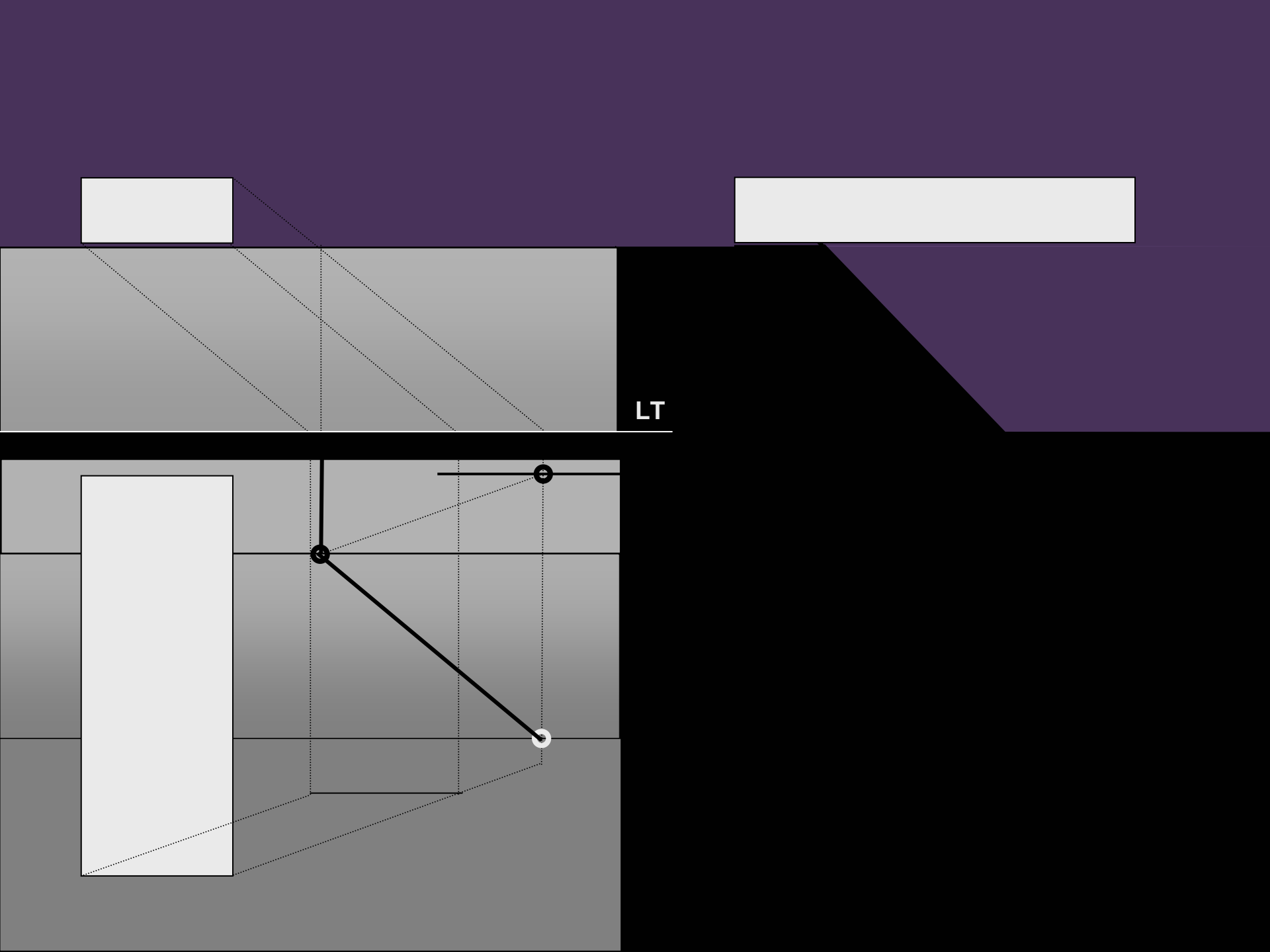

LT

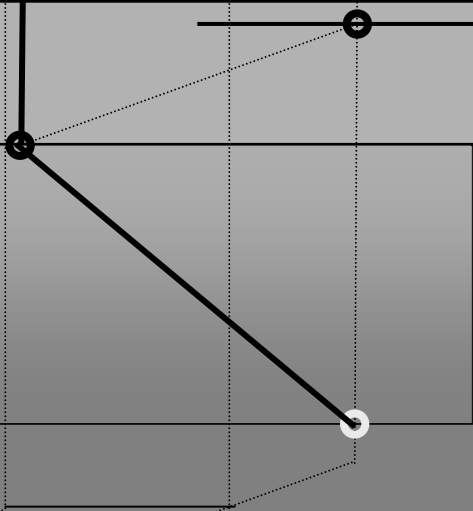
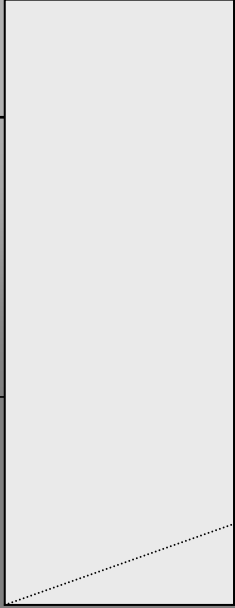

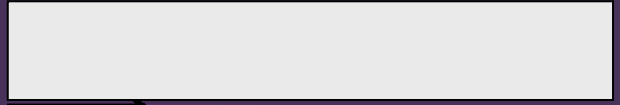
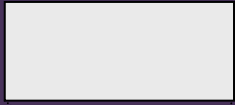
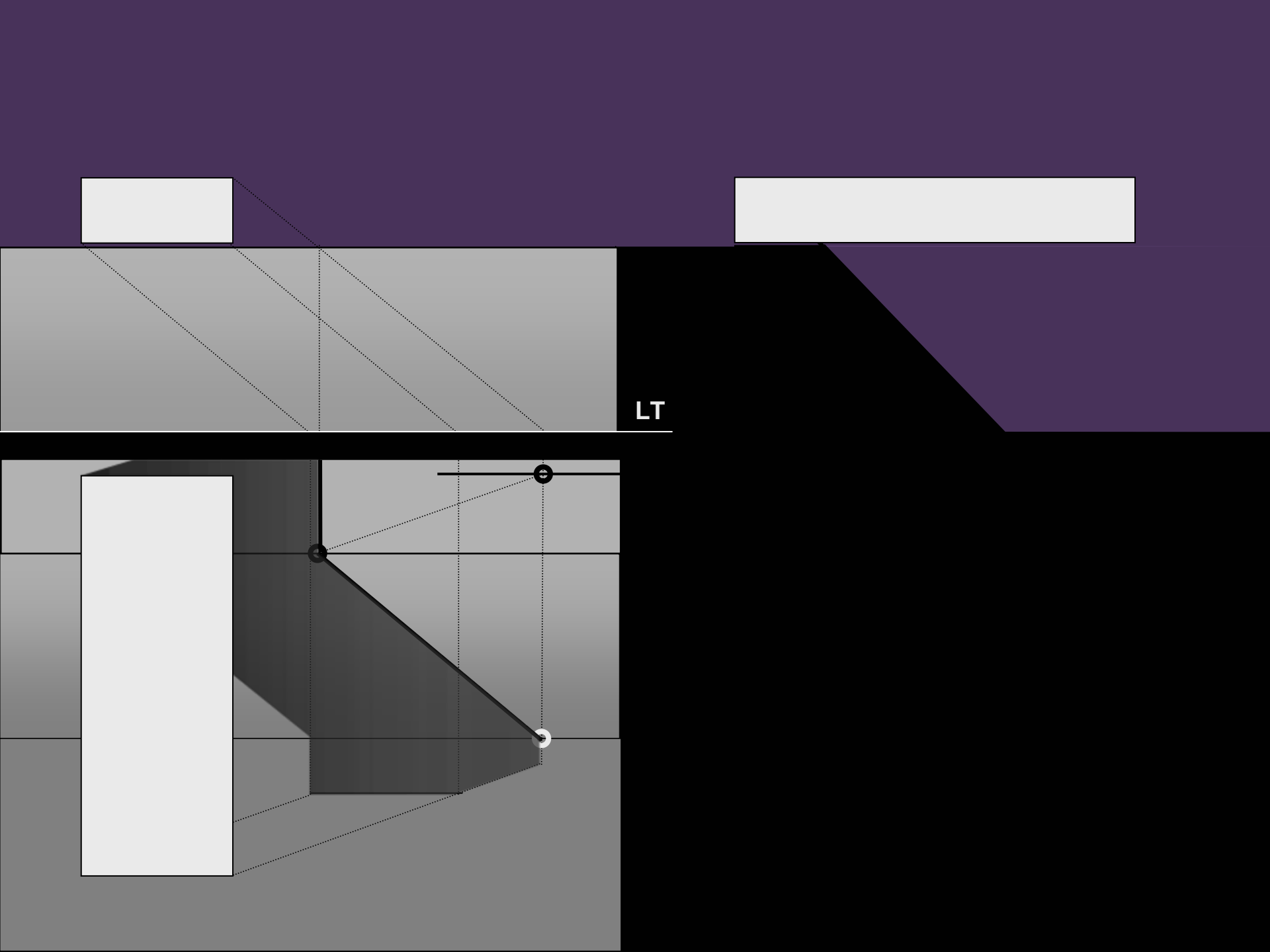

LT

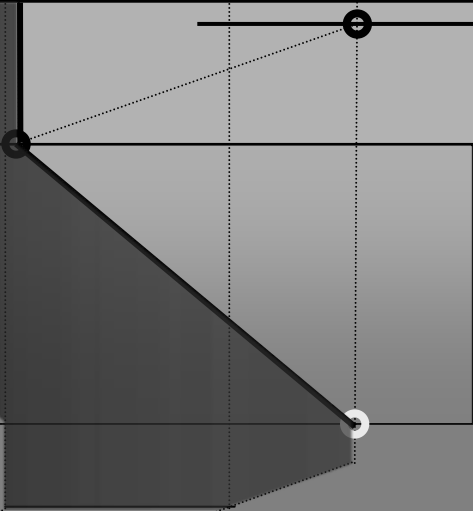
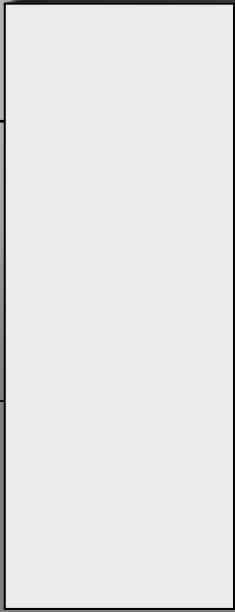

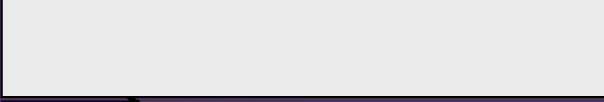
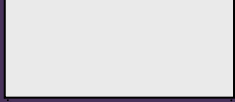
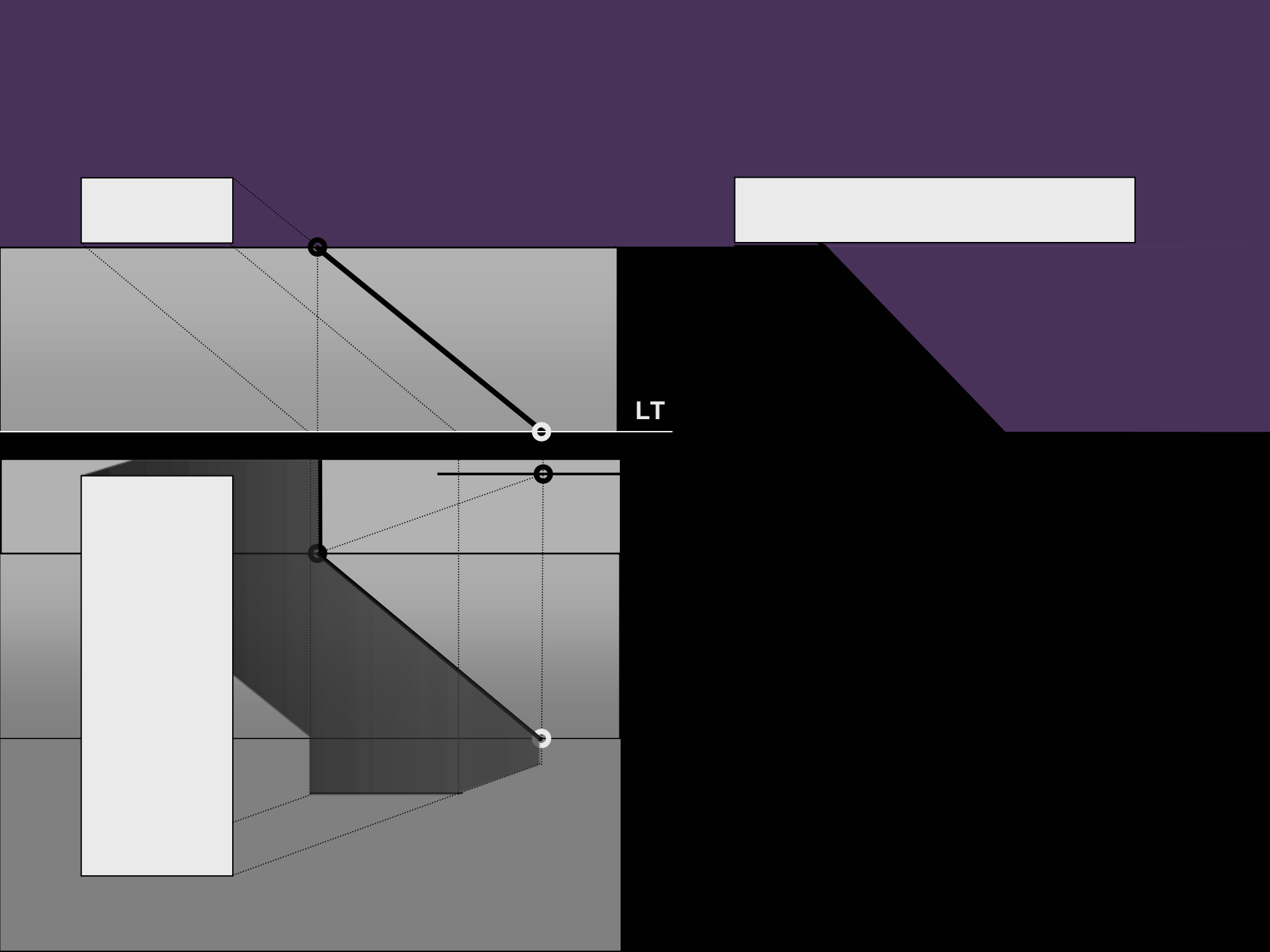

LT

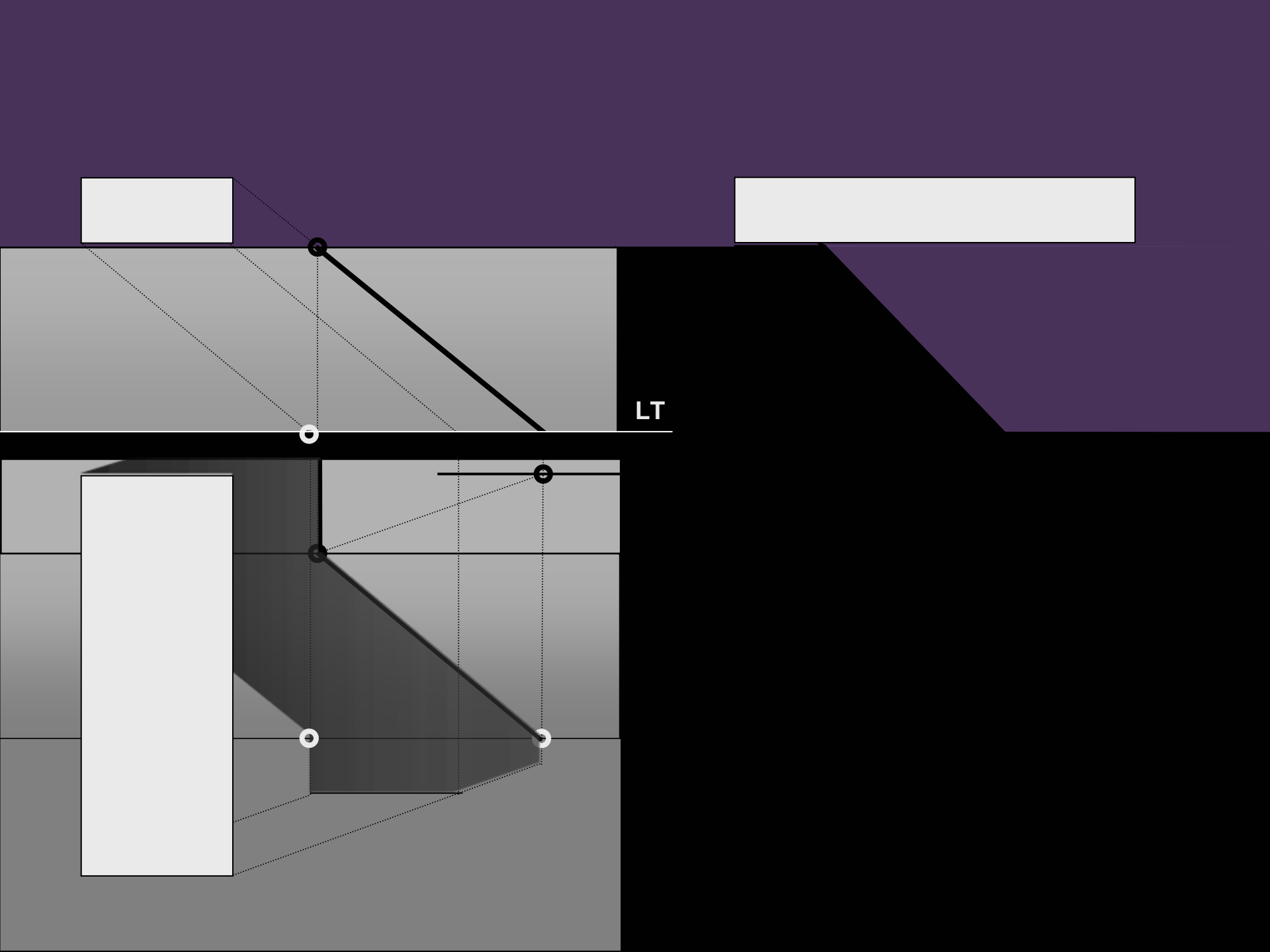

LT

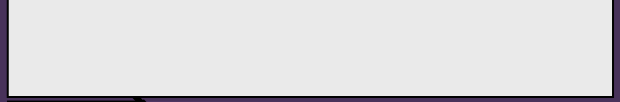
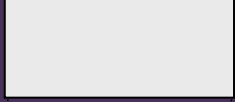
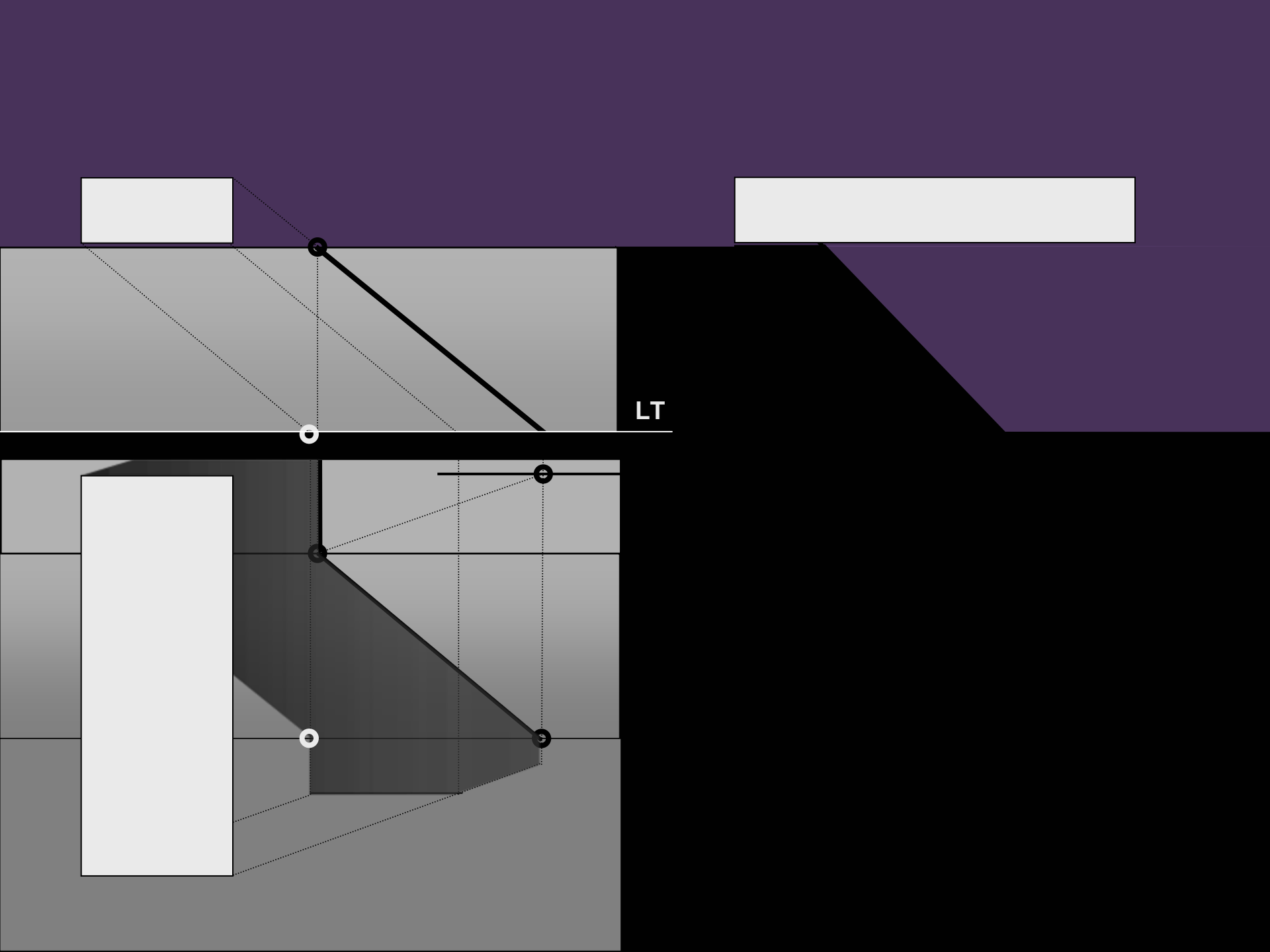

LT



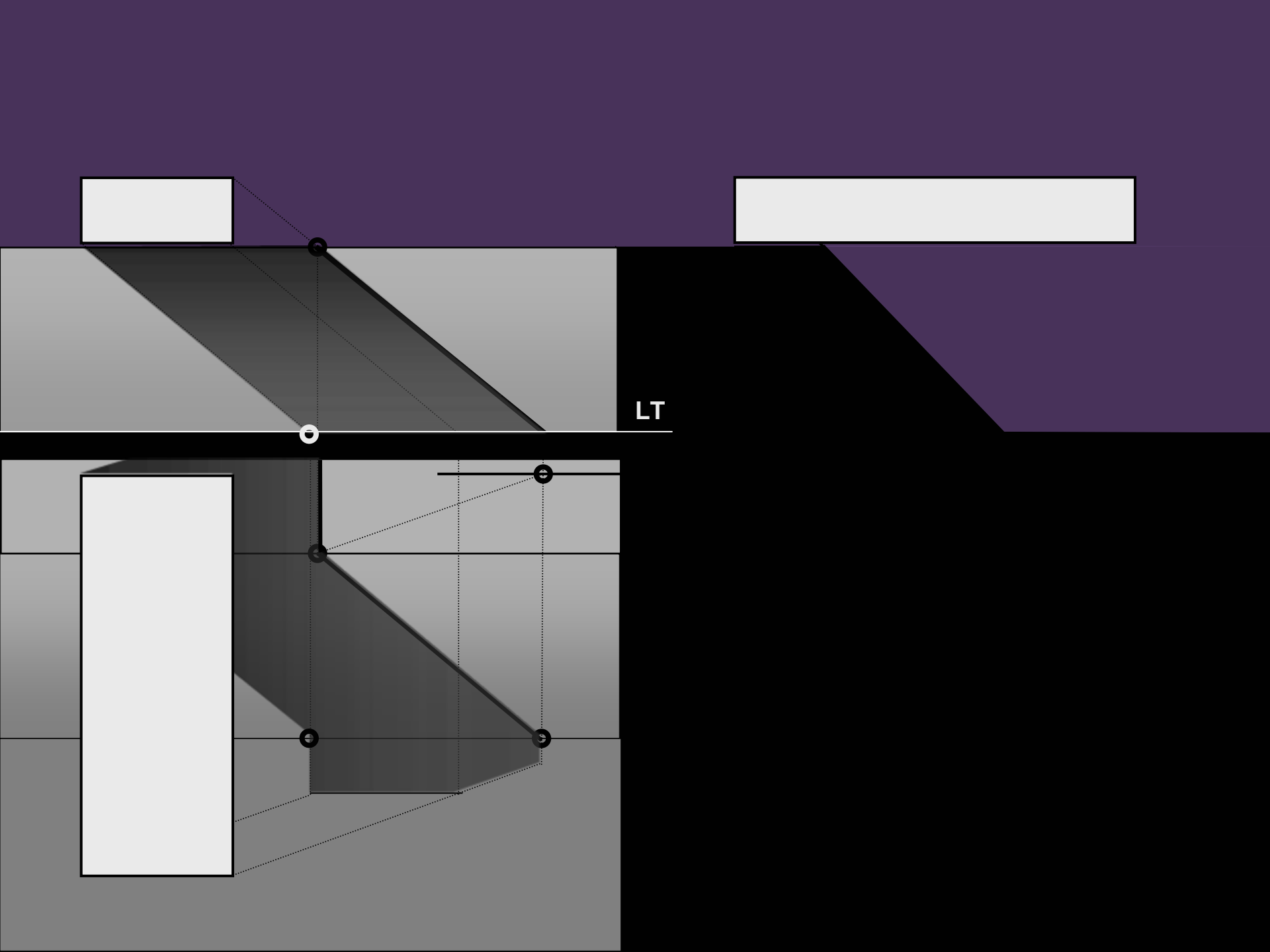

LT

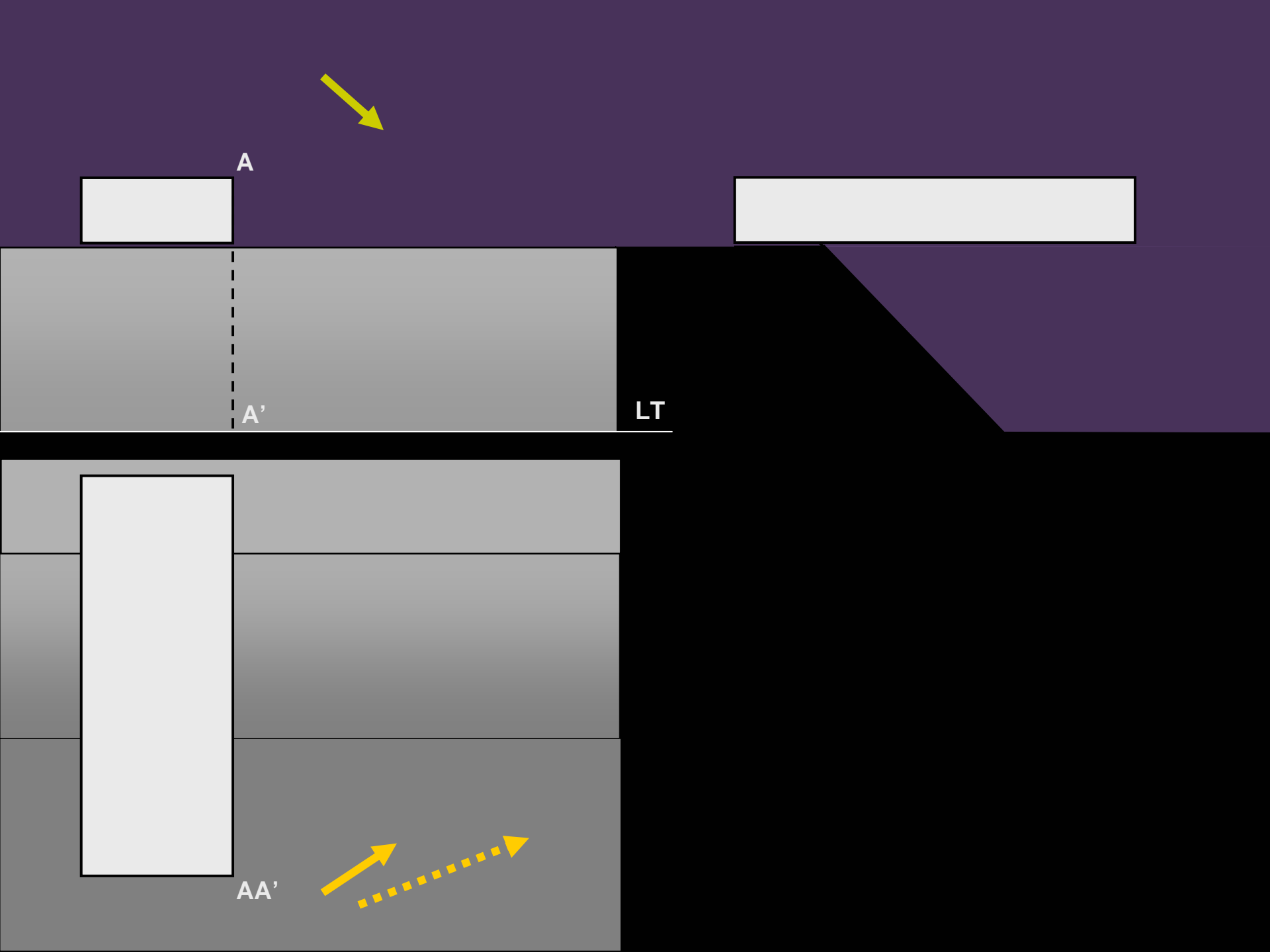

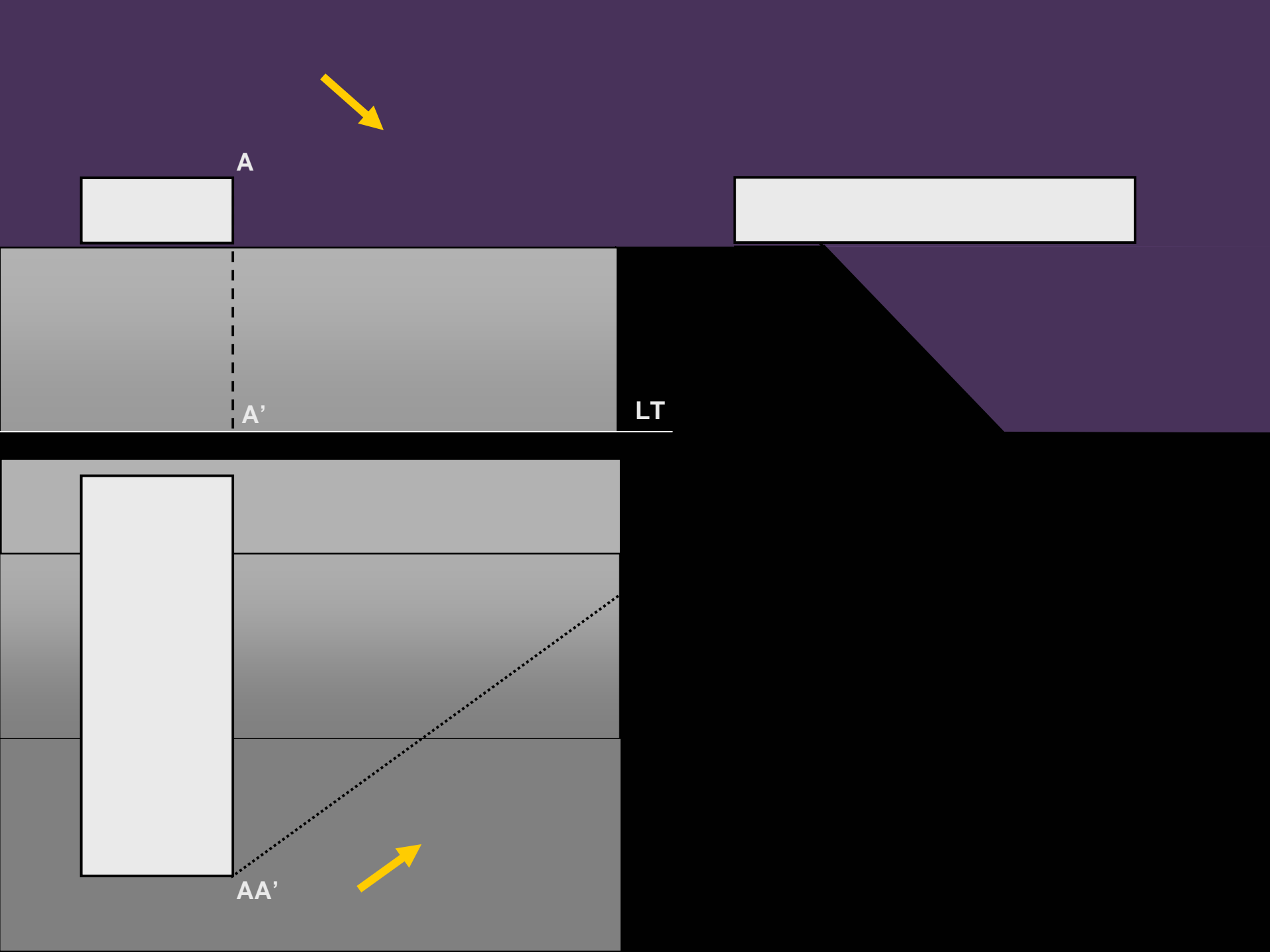

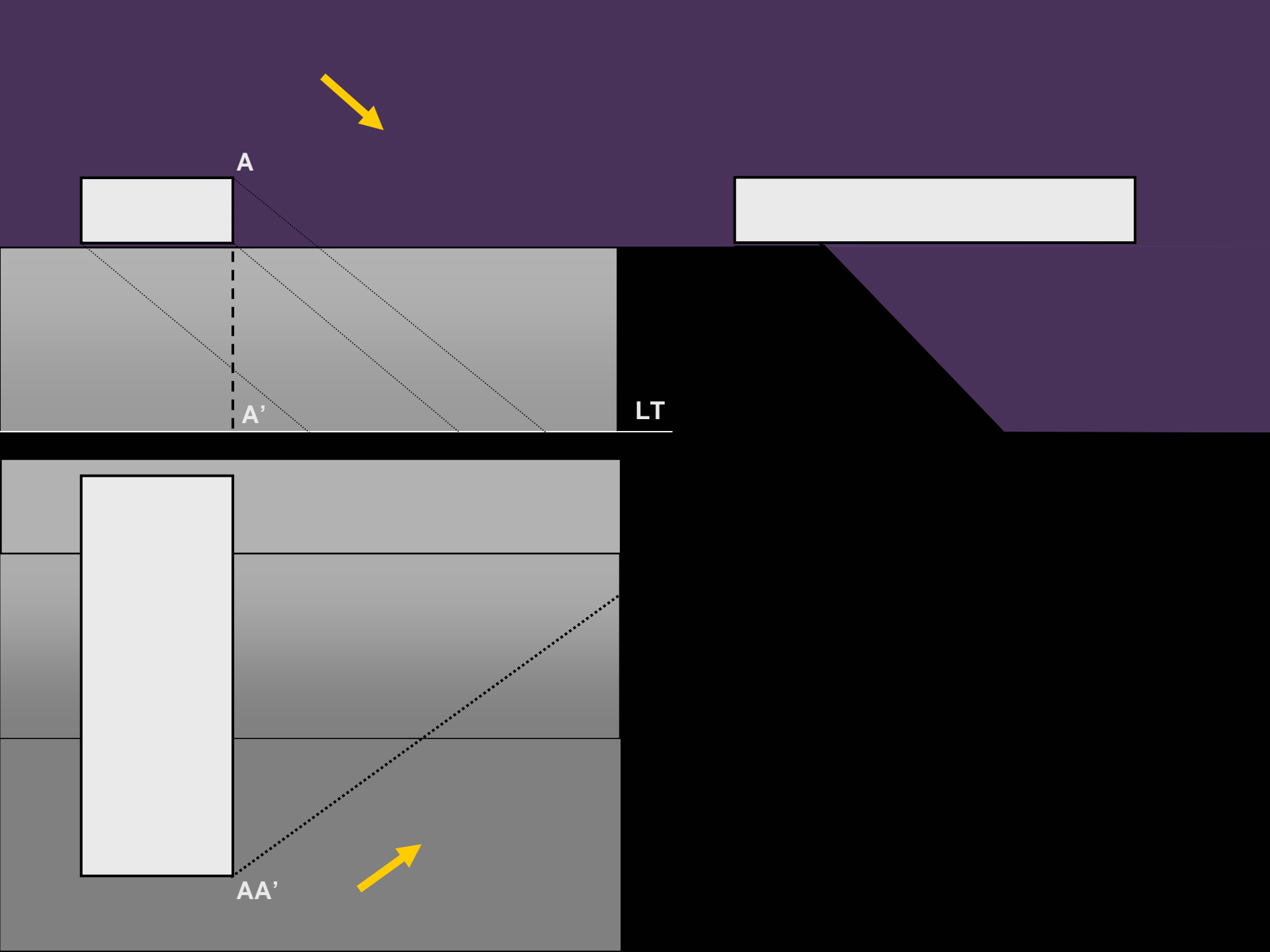

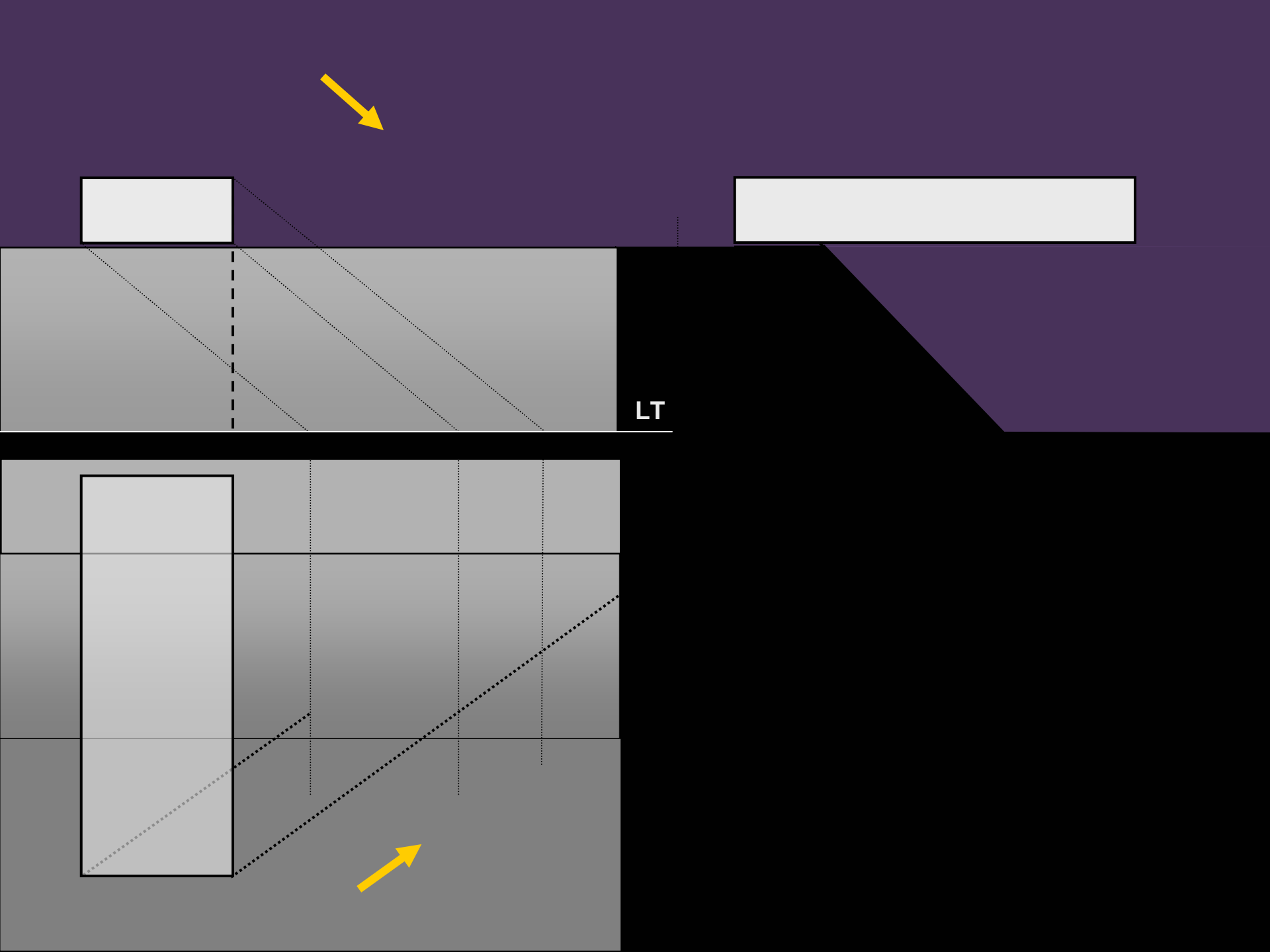

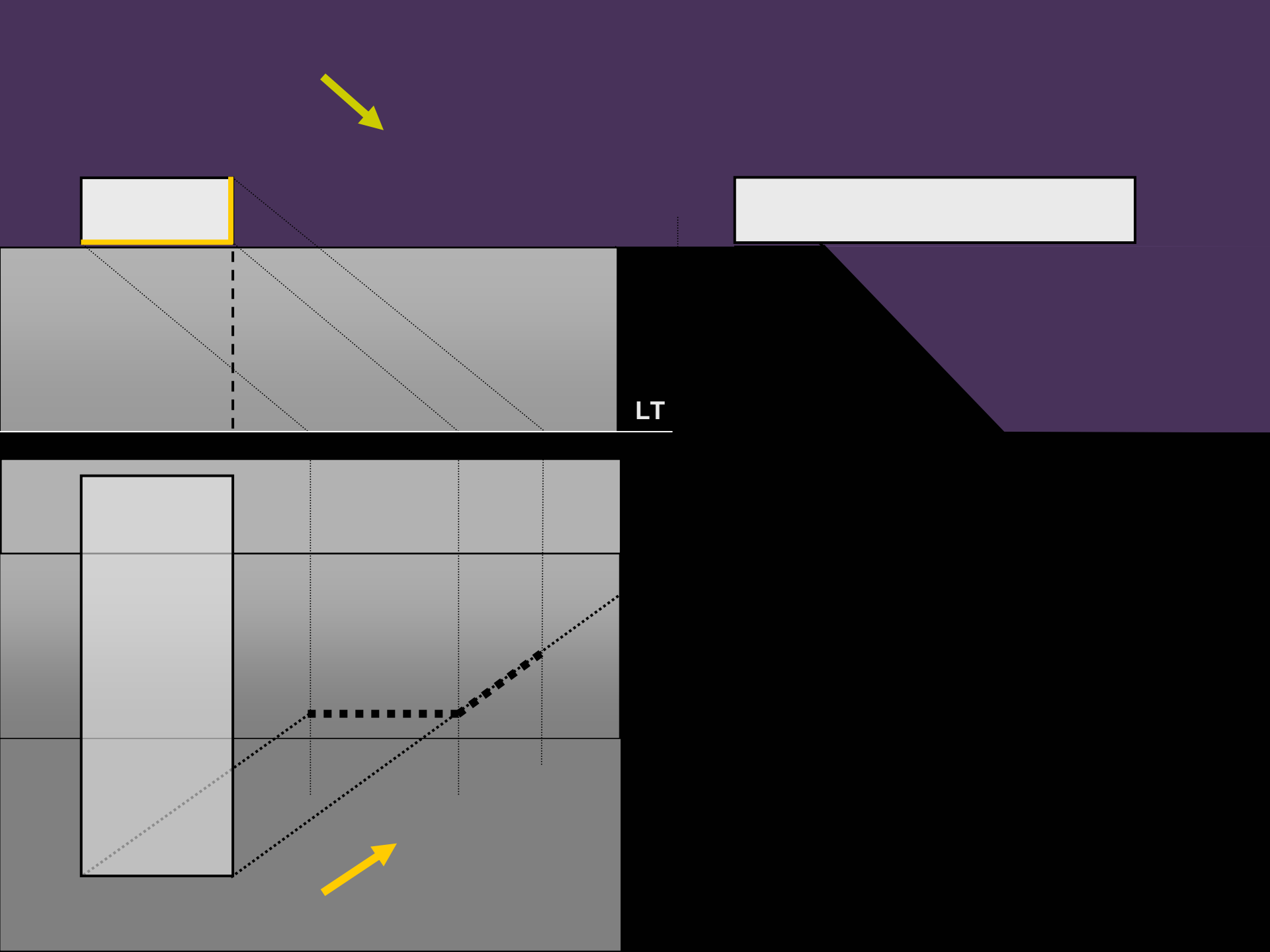

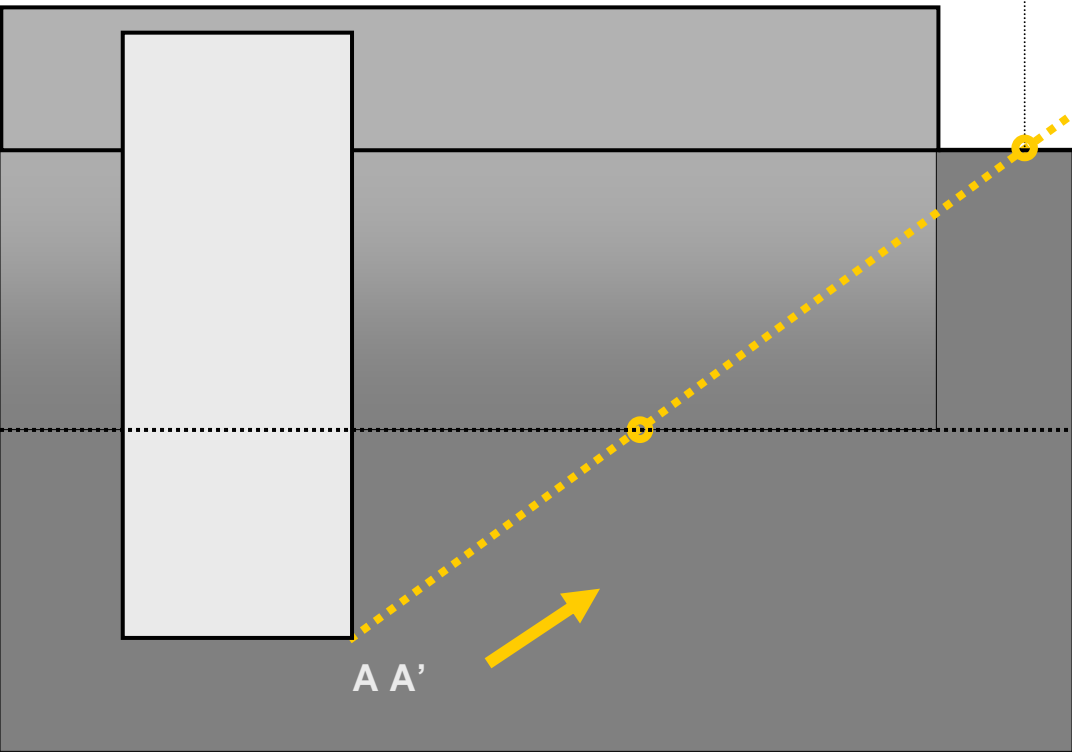
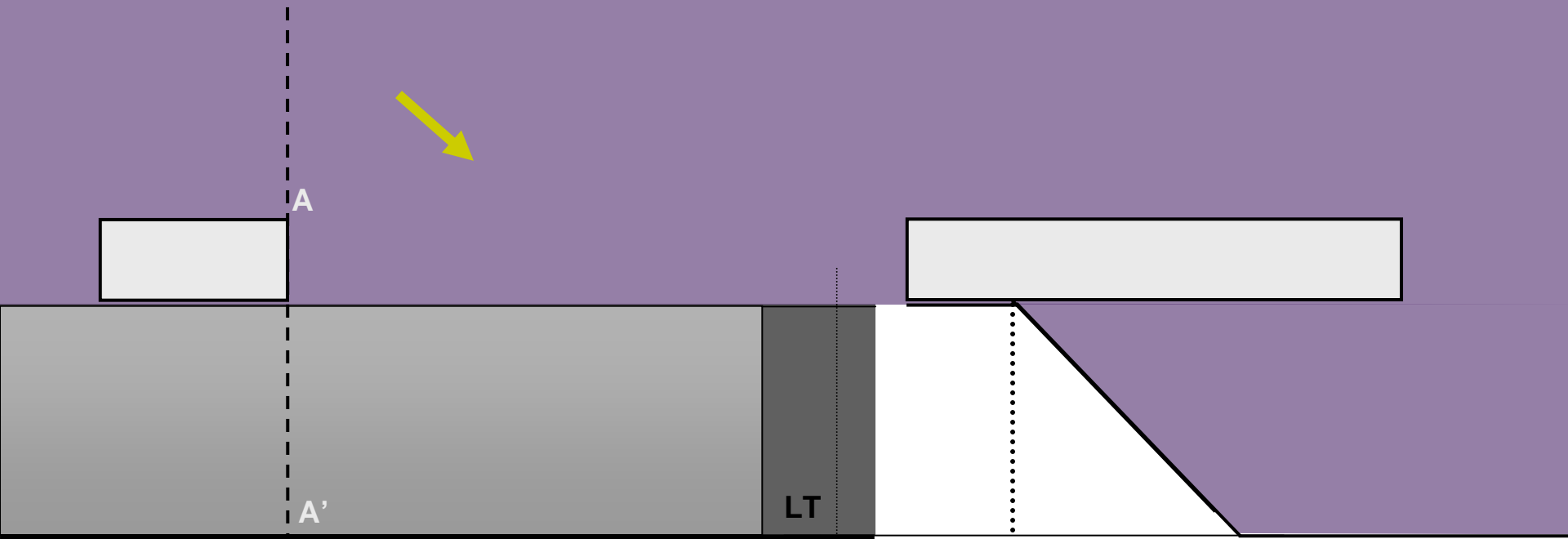

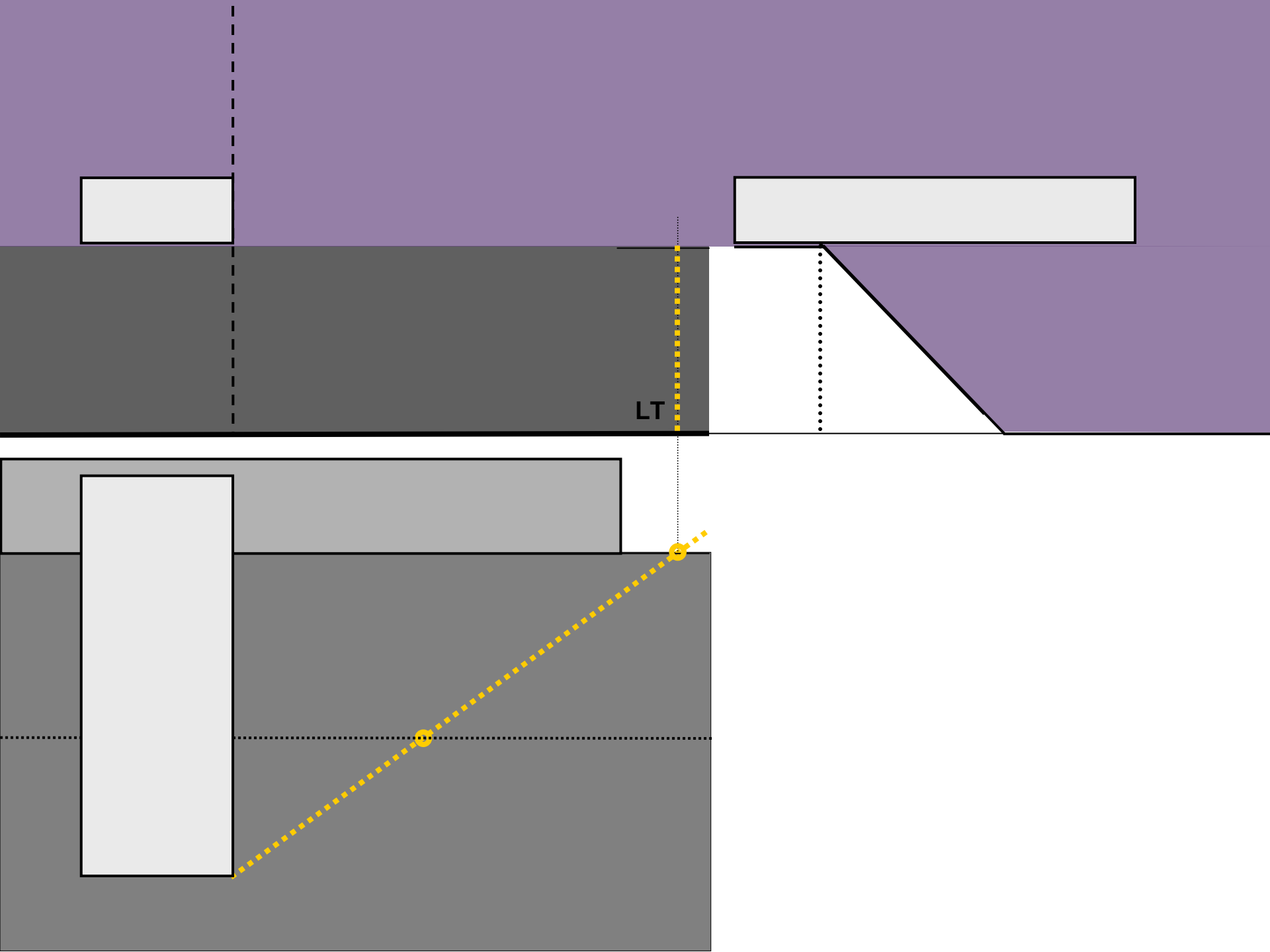

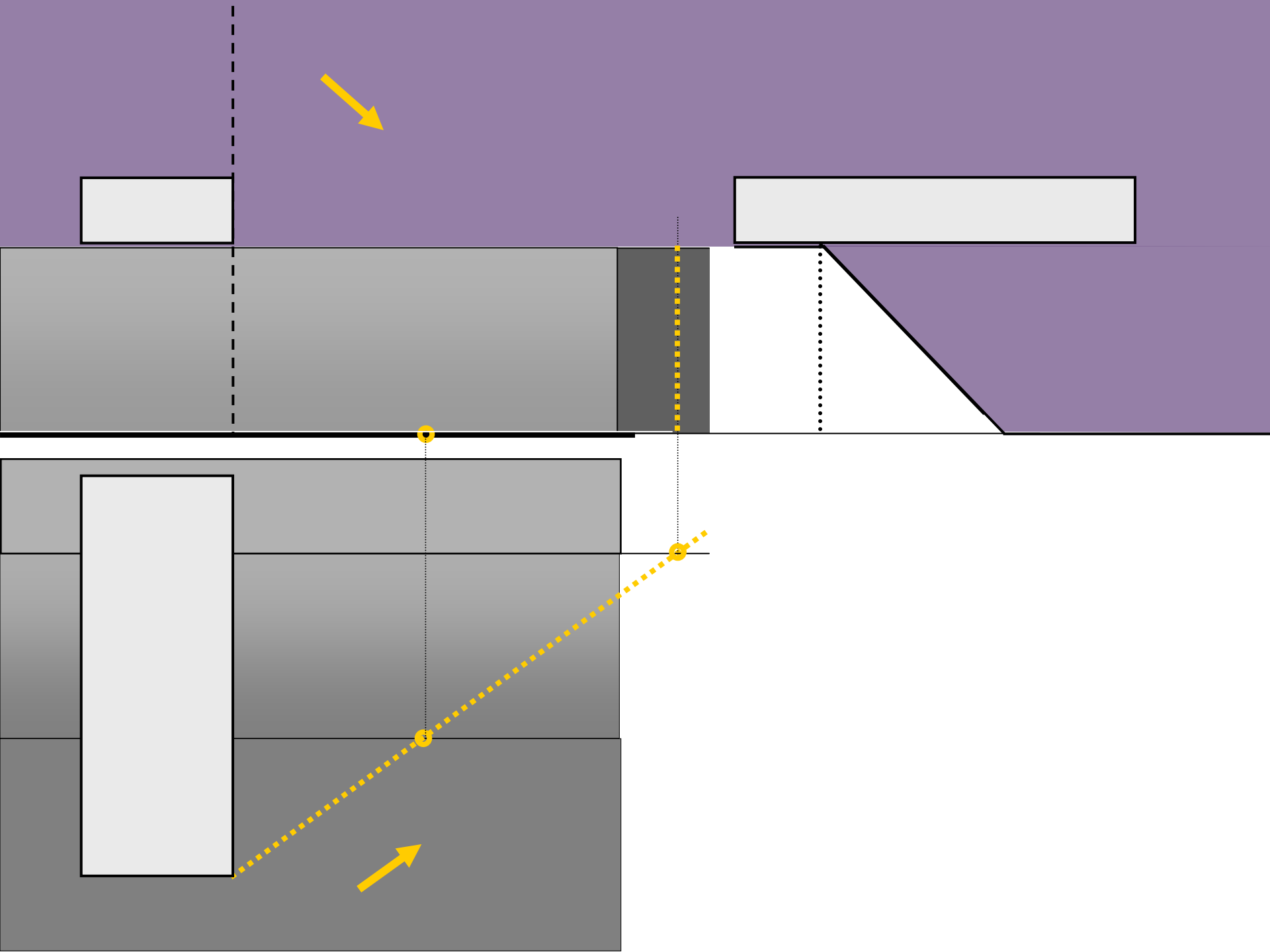

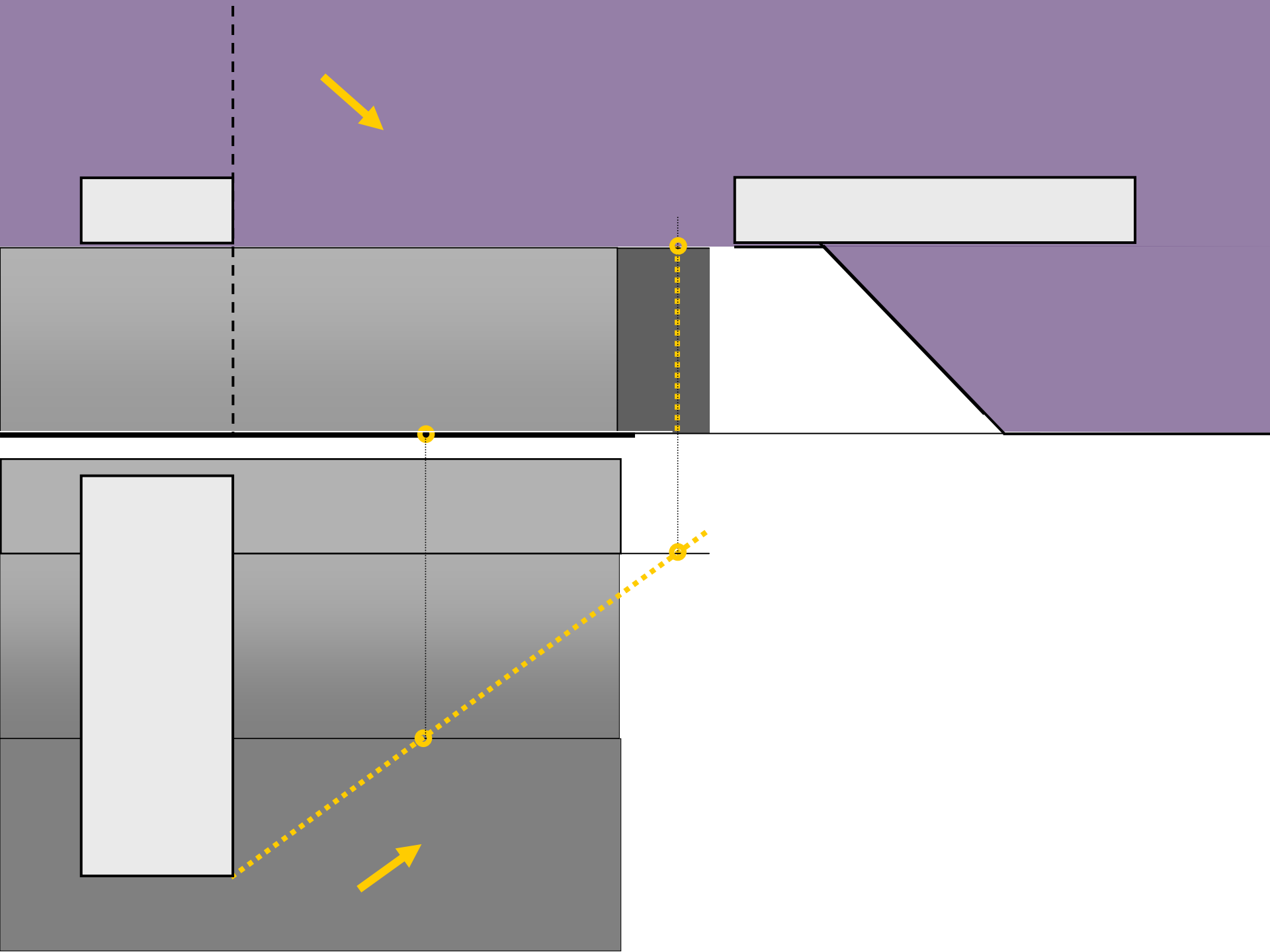

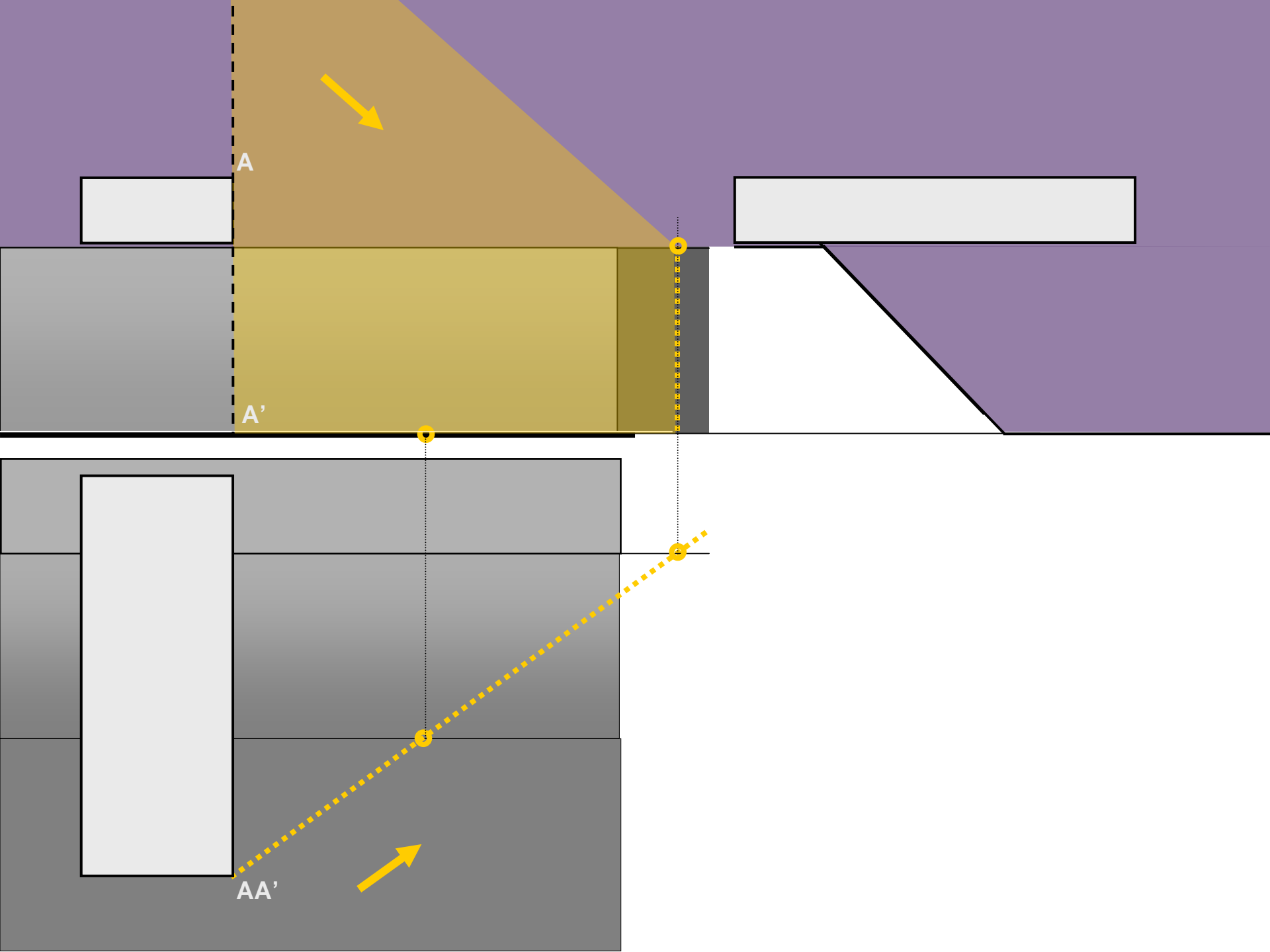

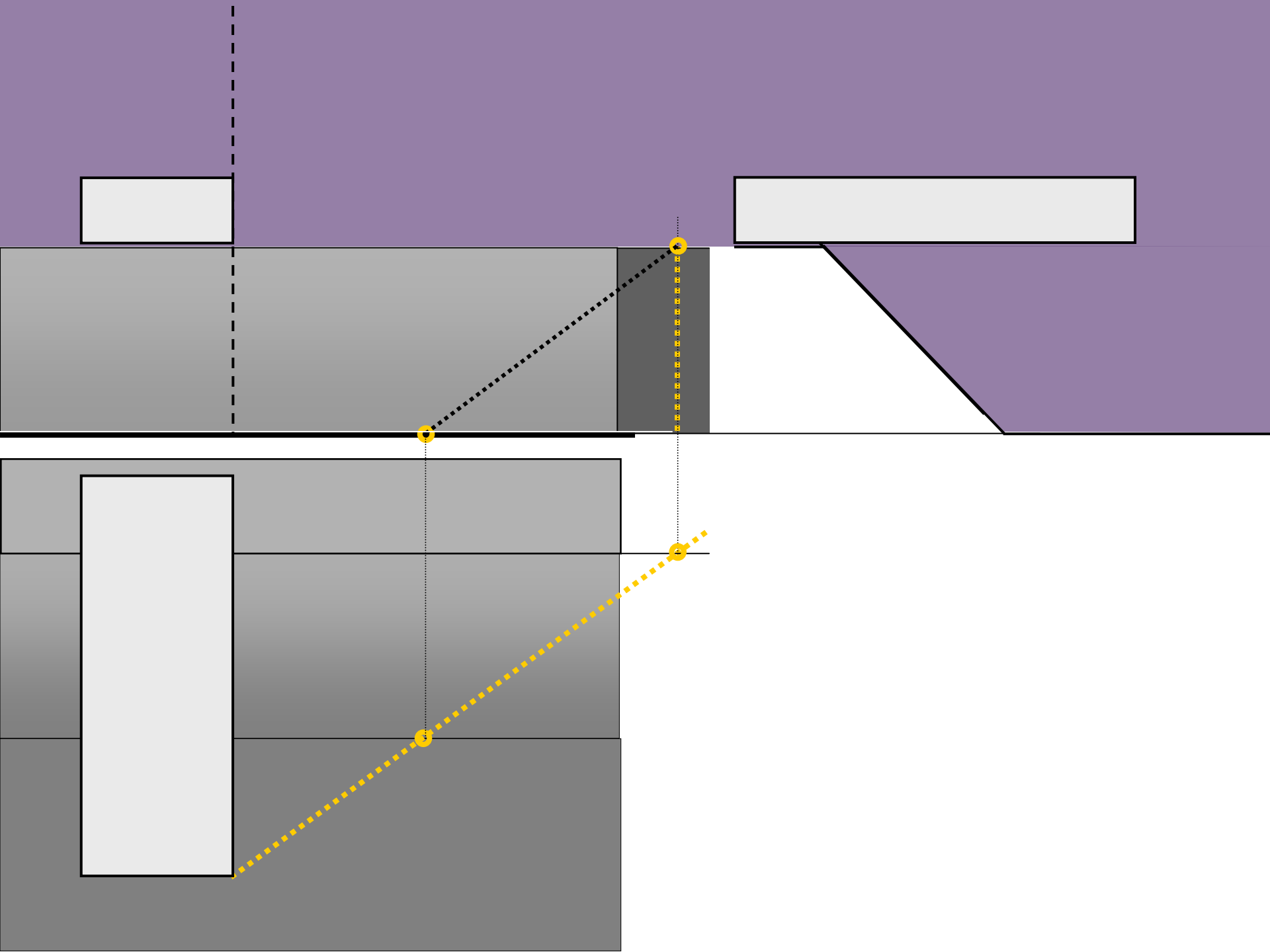

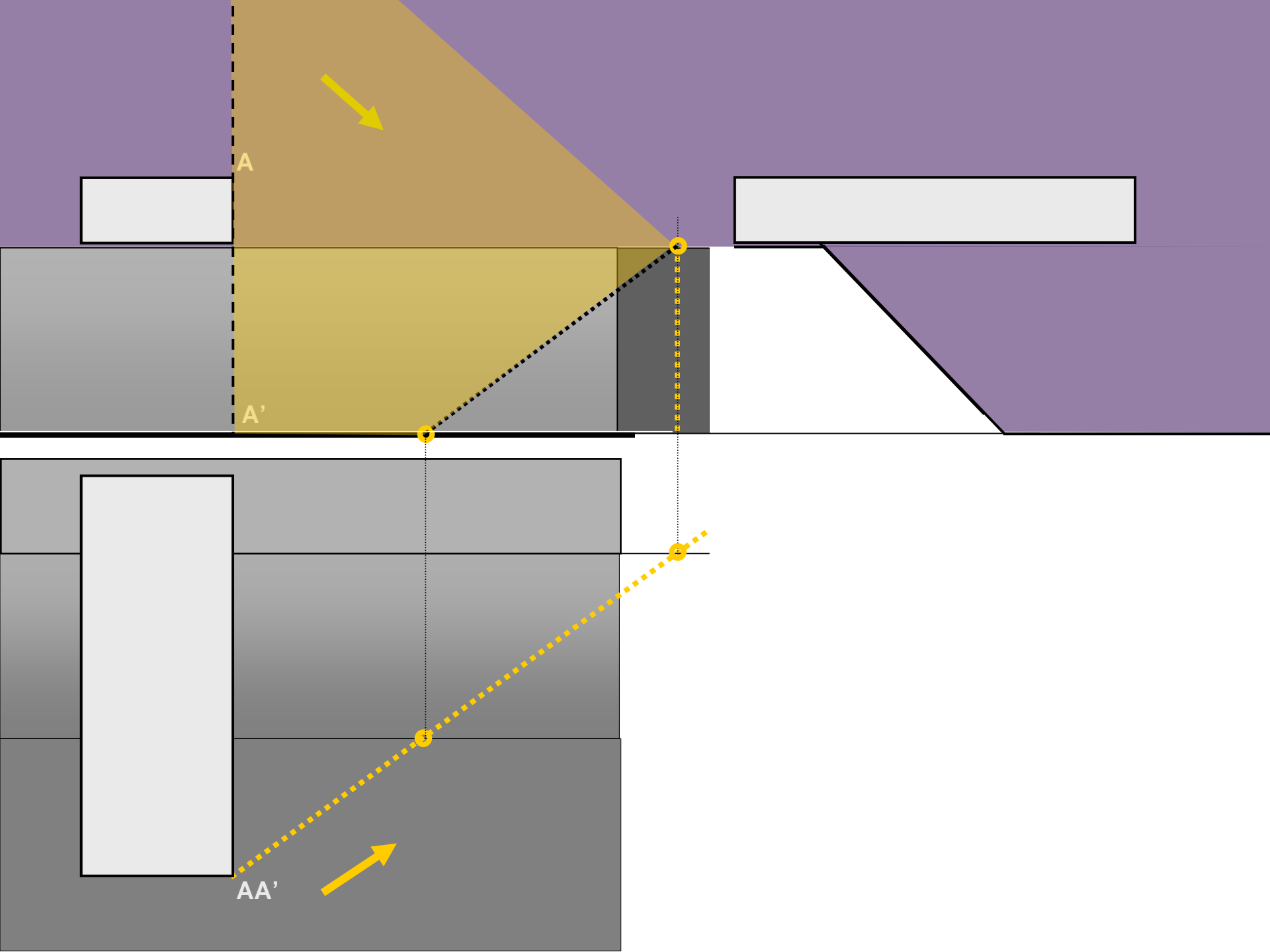

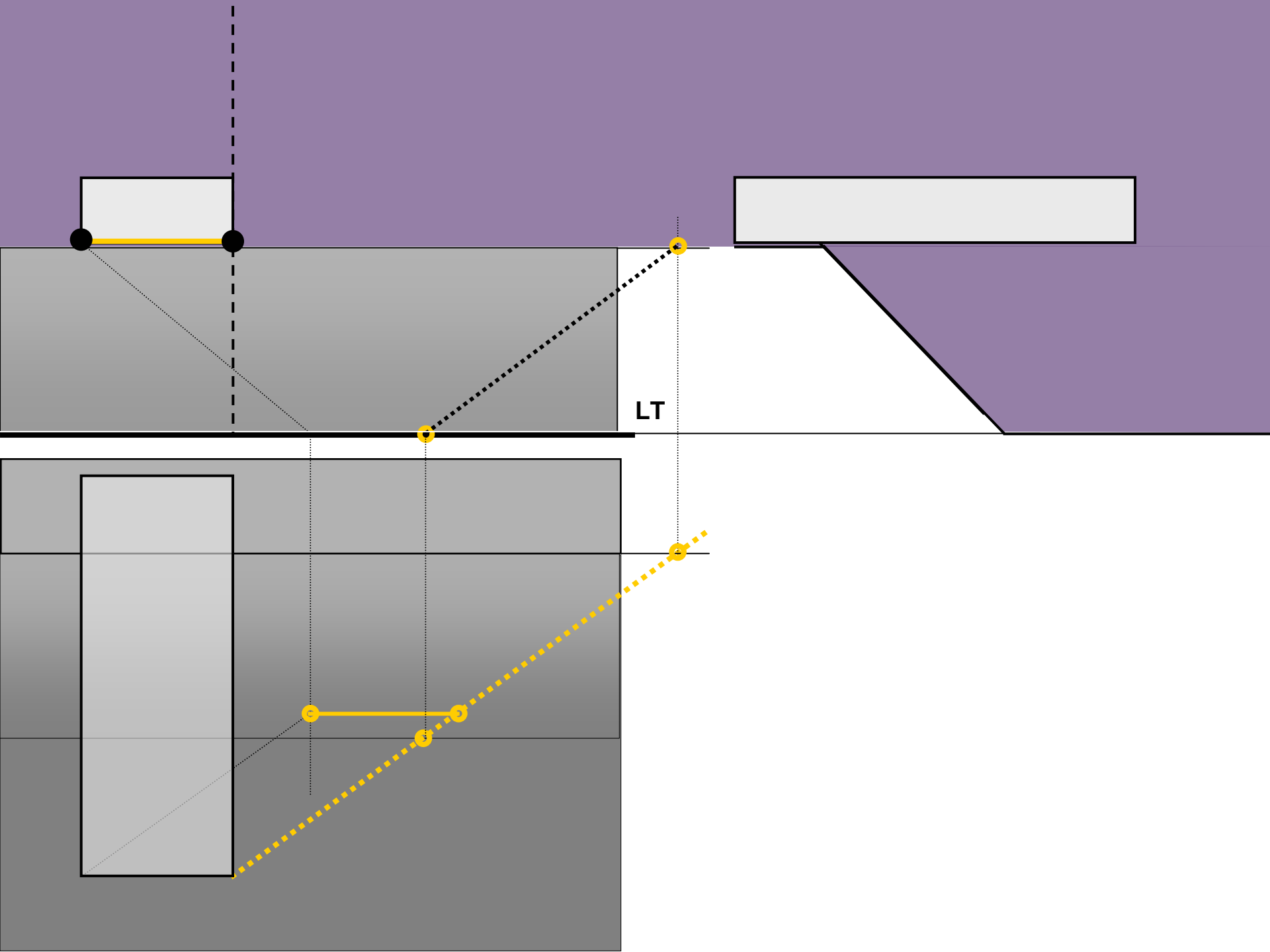

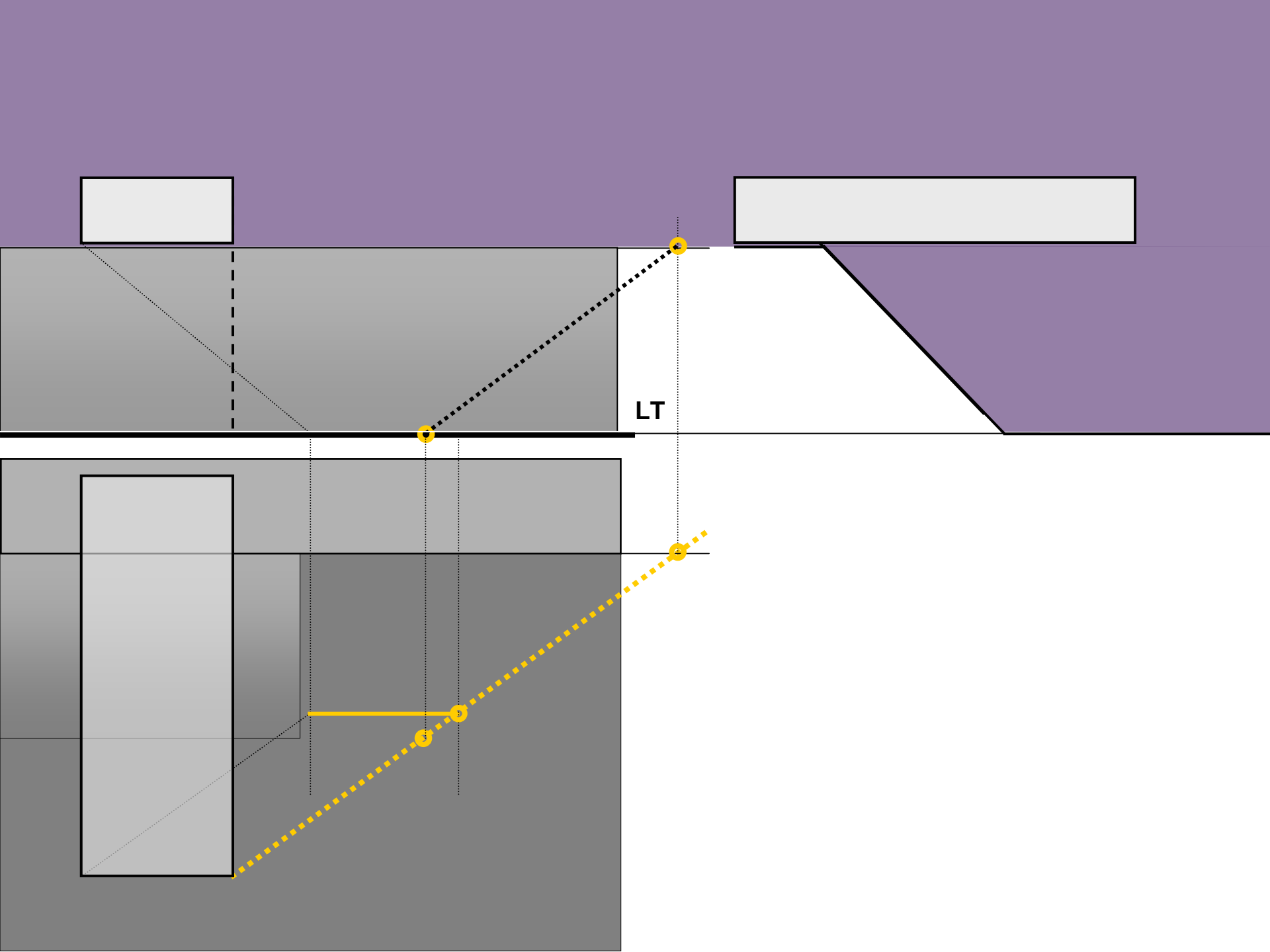

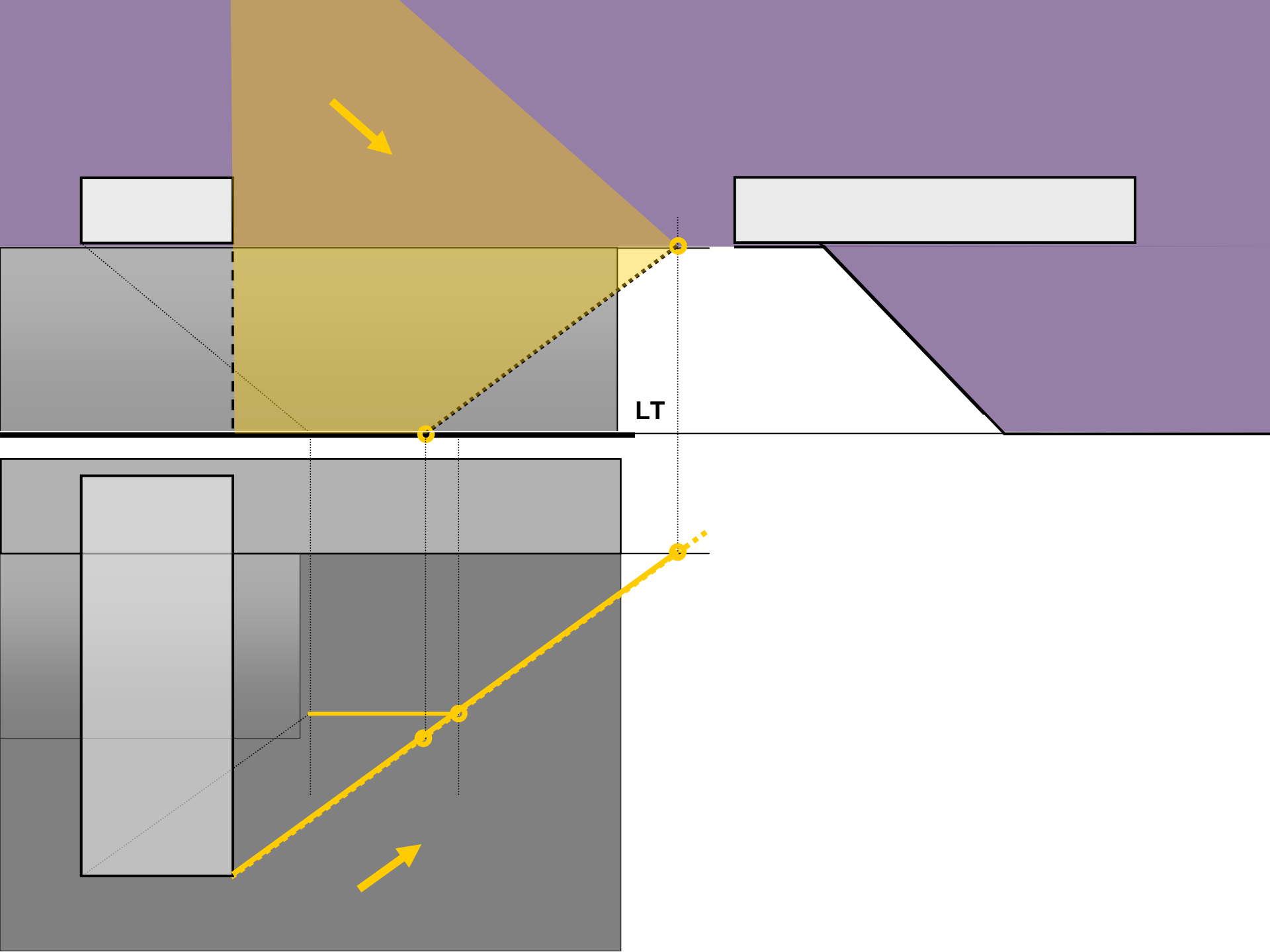

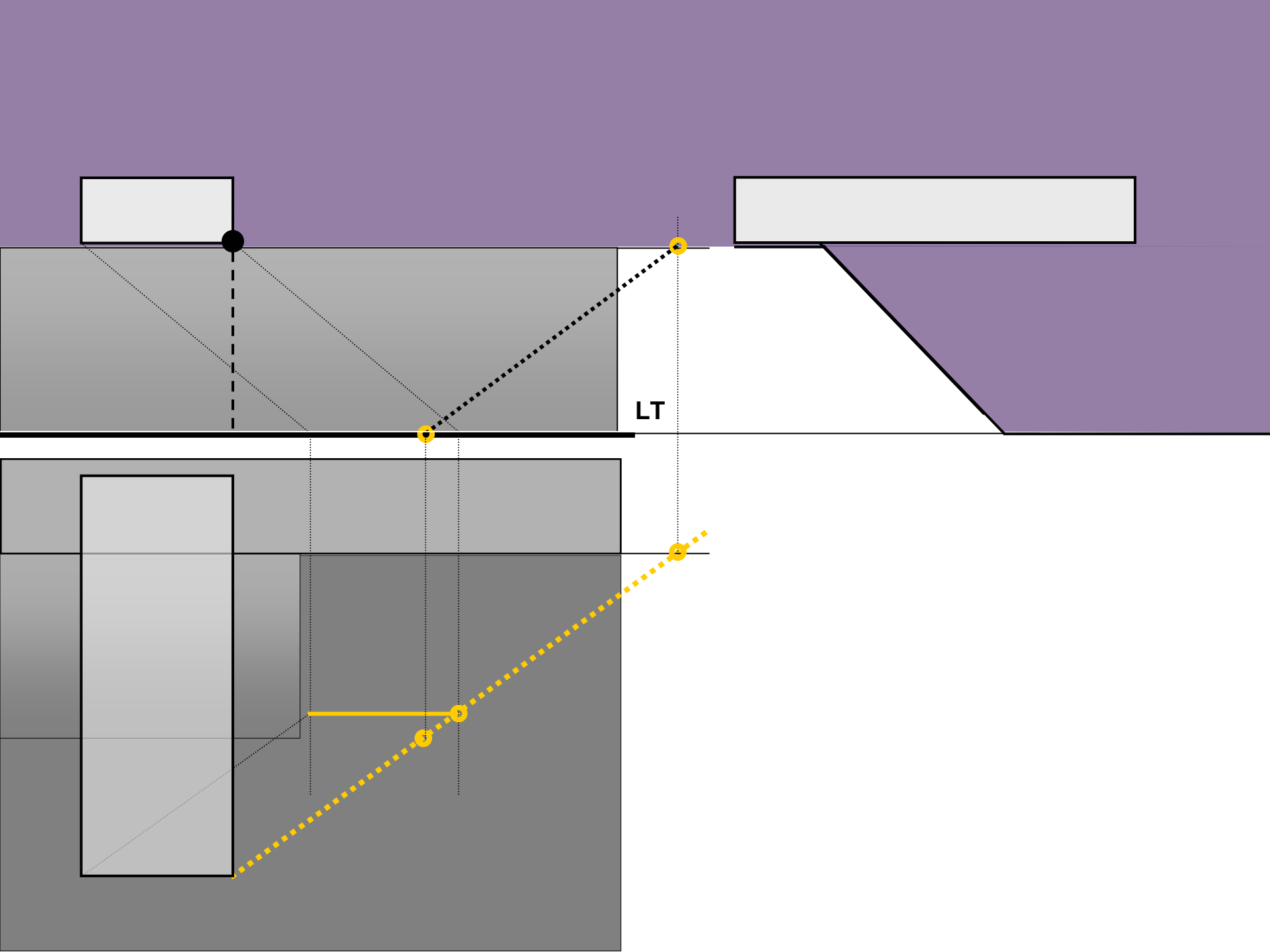

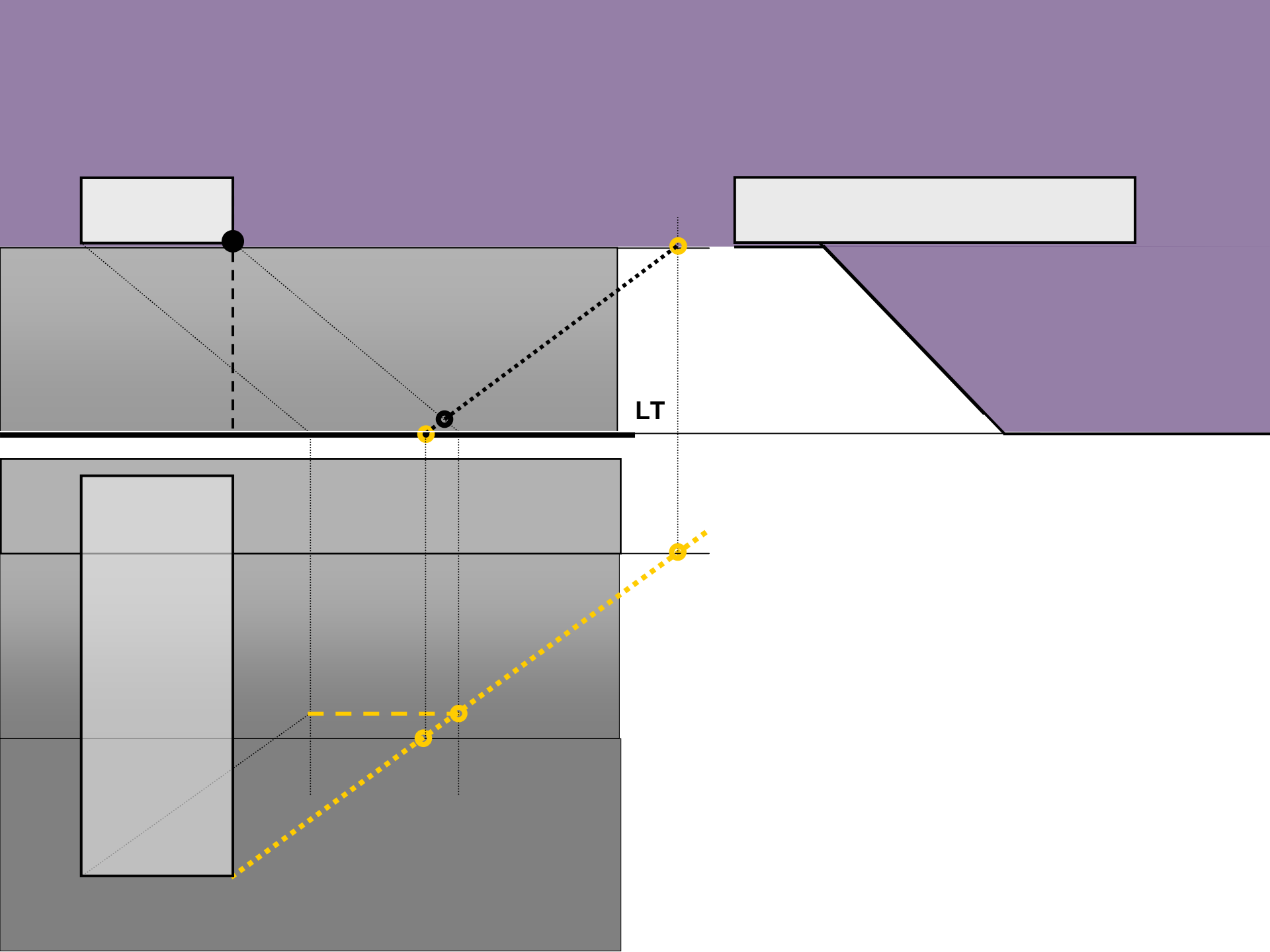

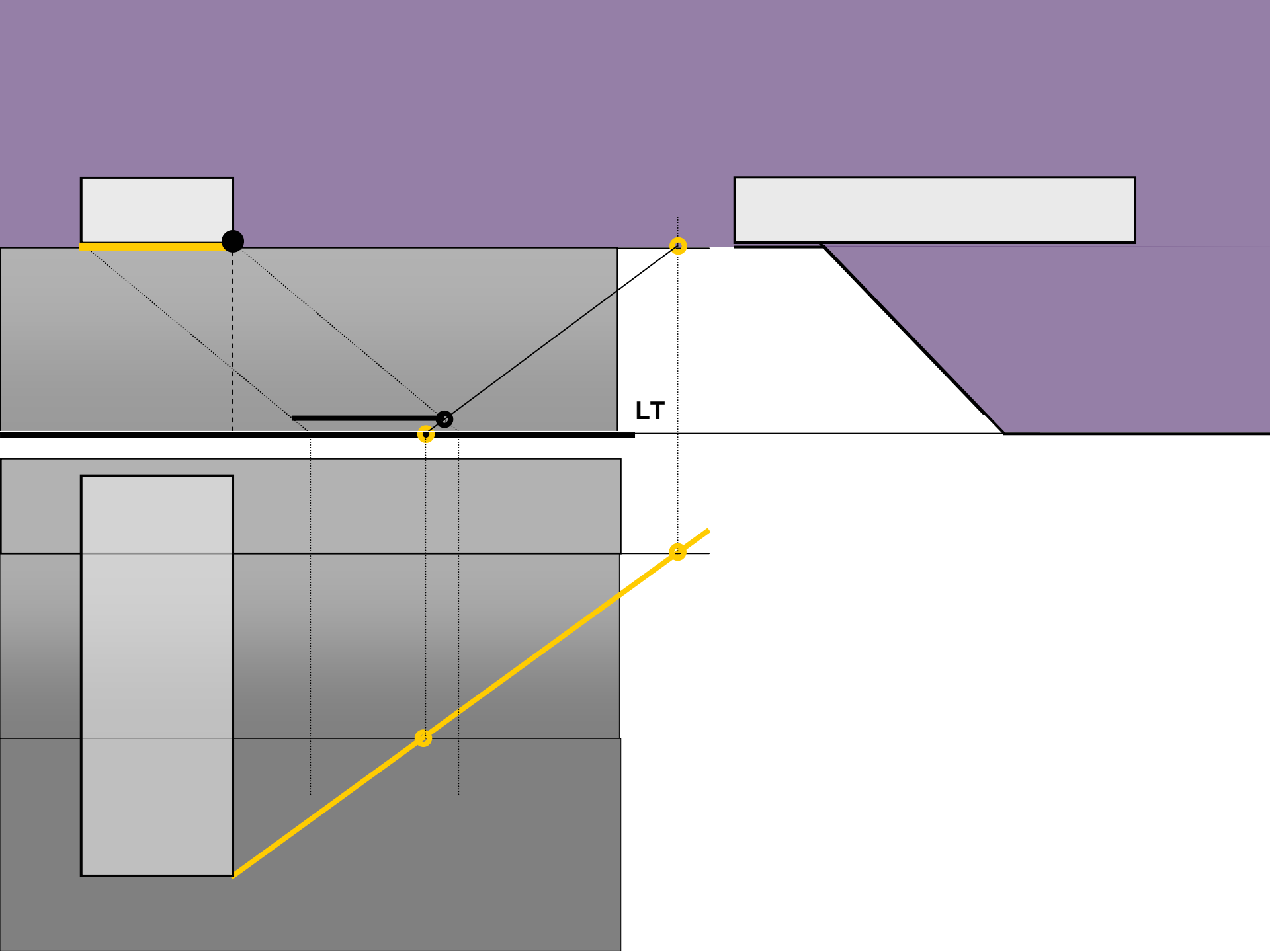

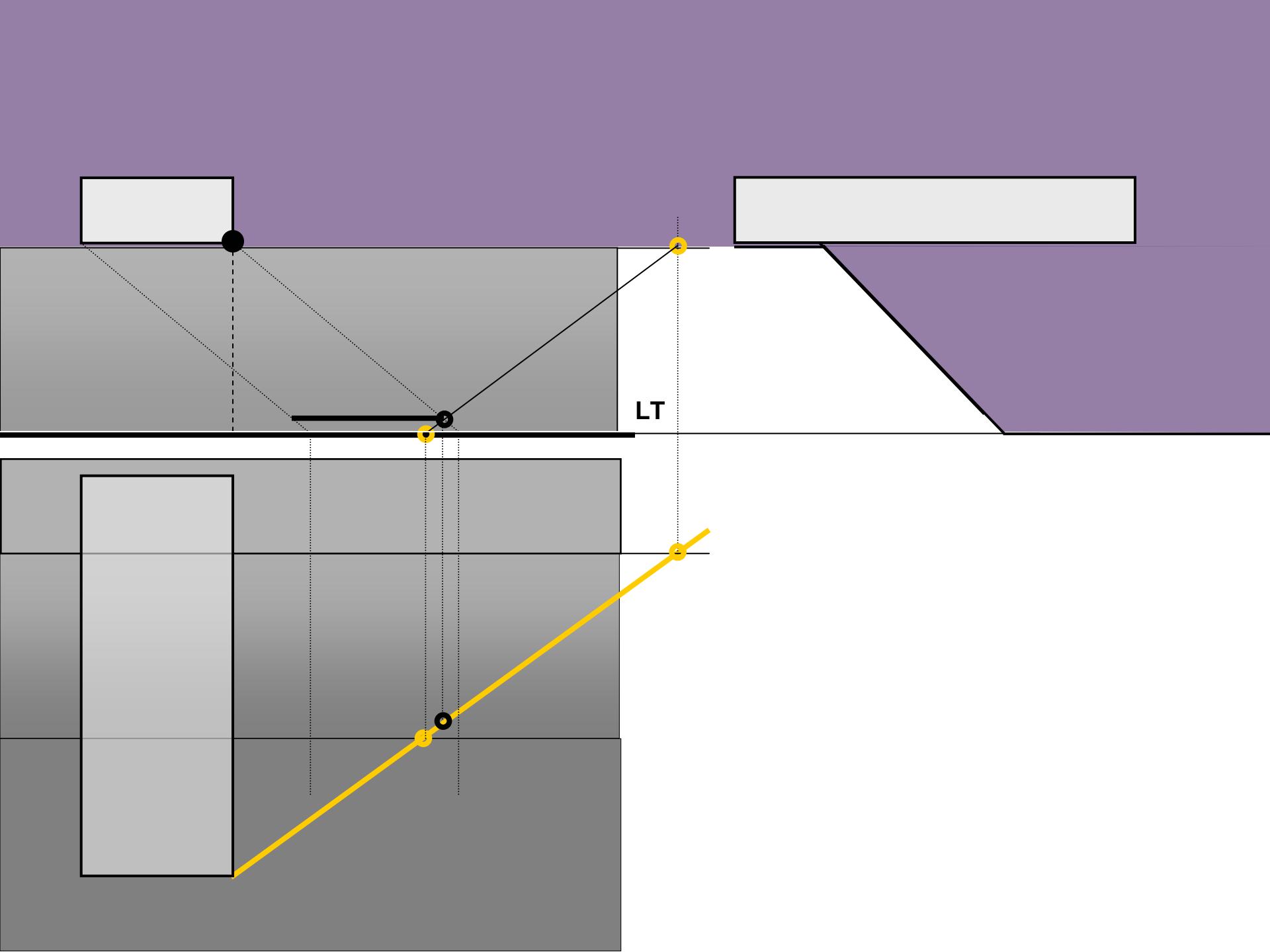

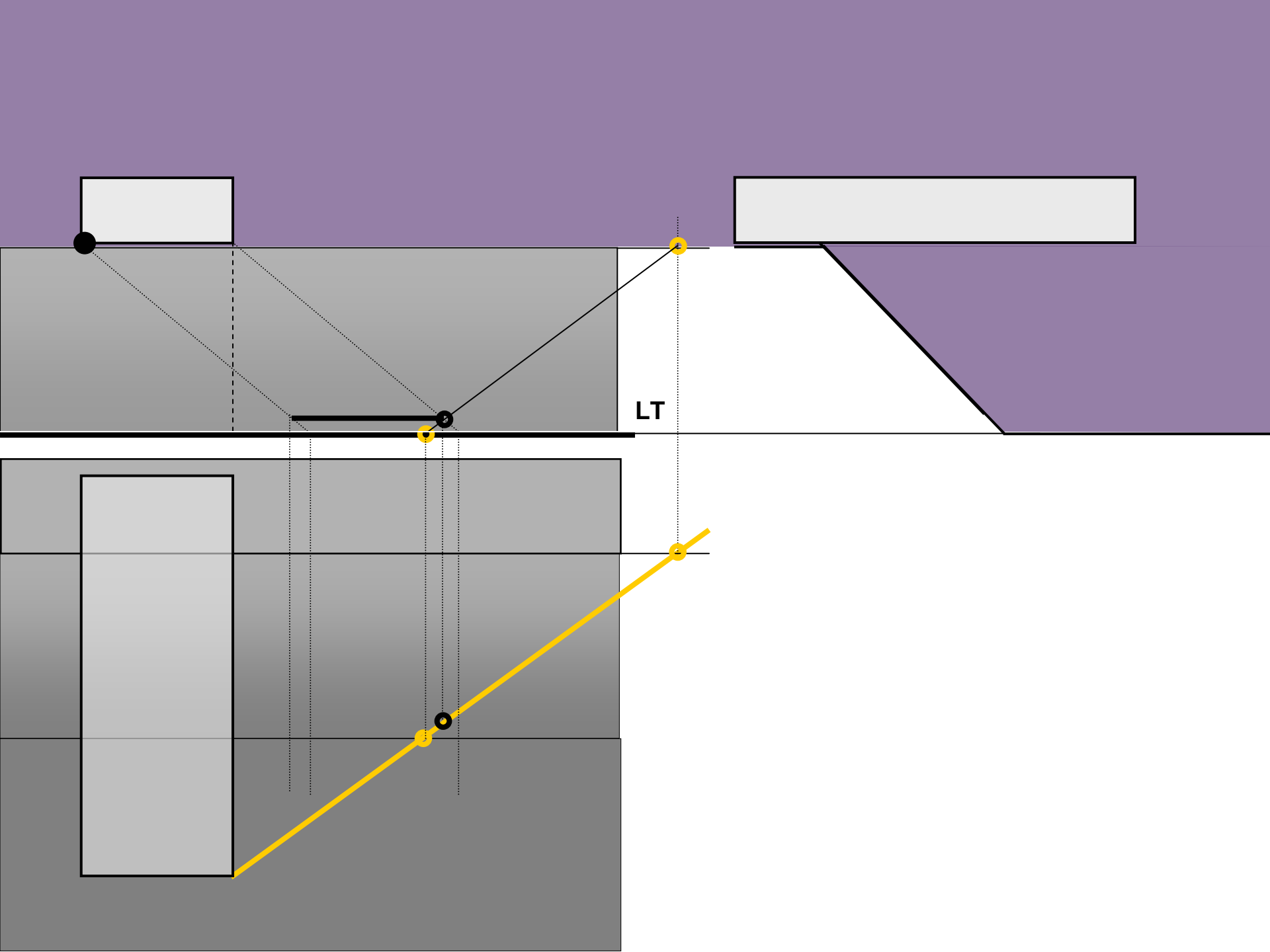

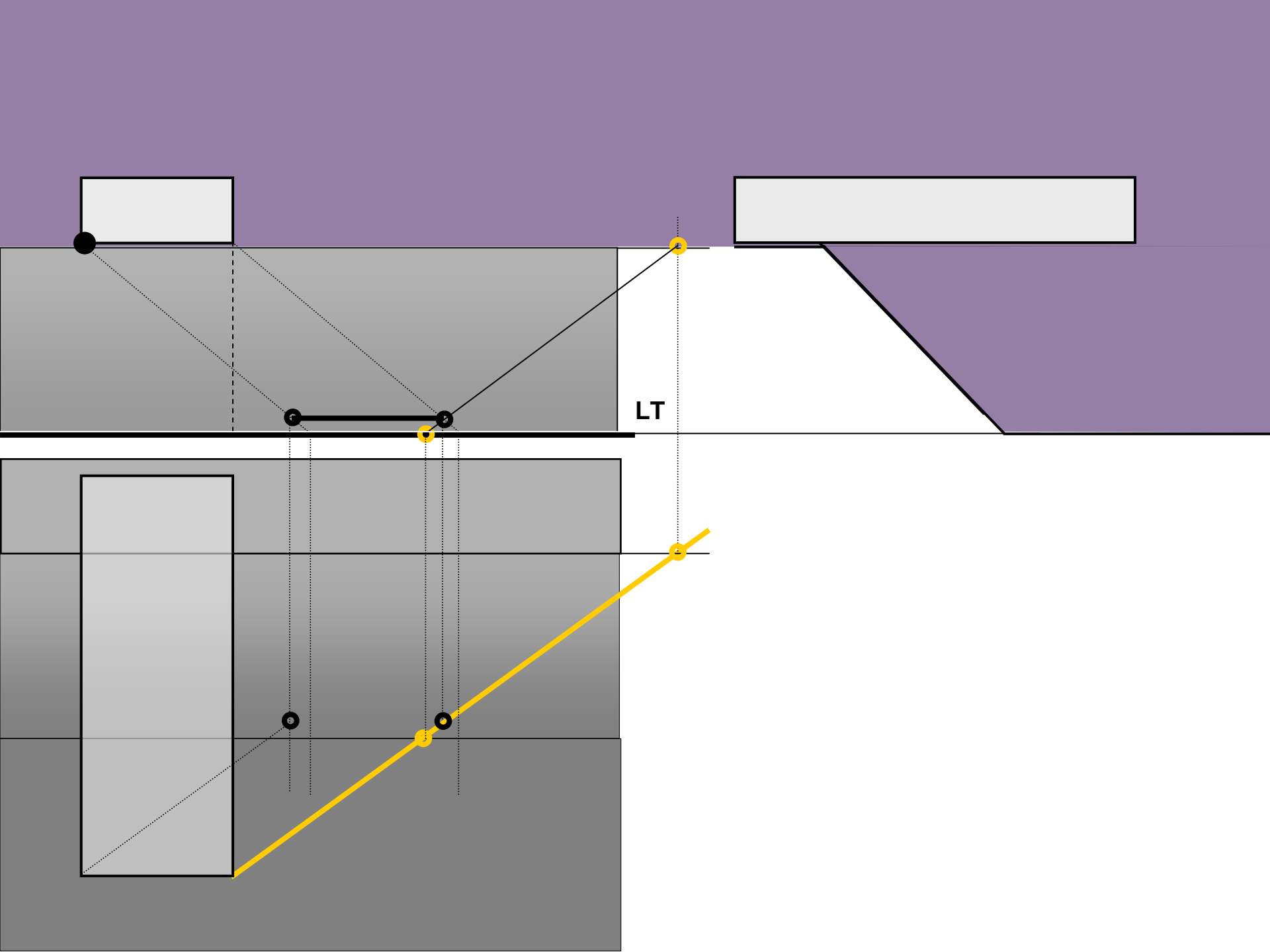

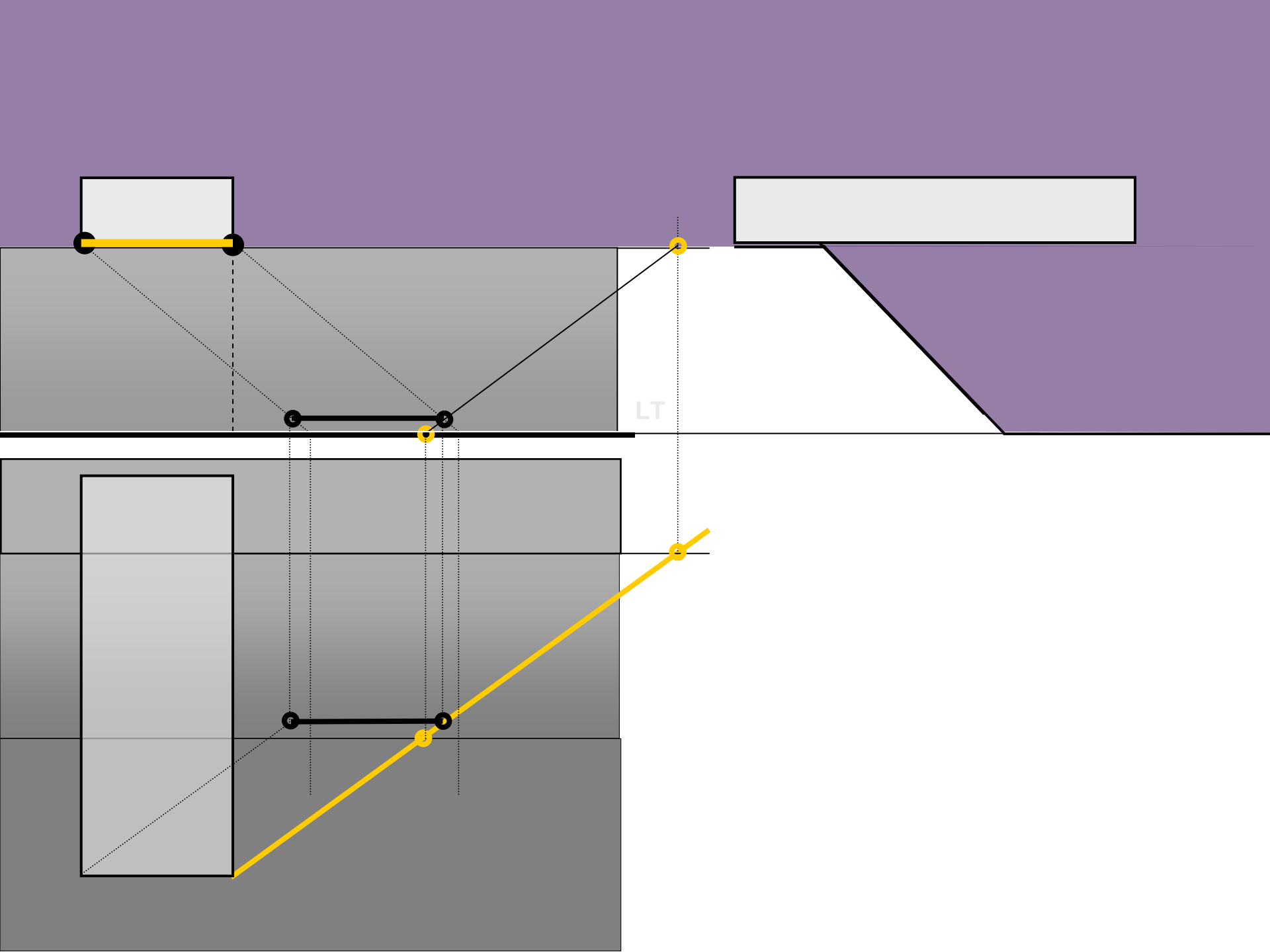

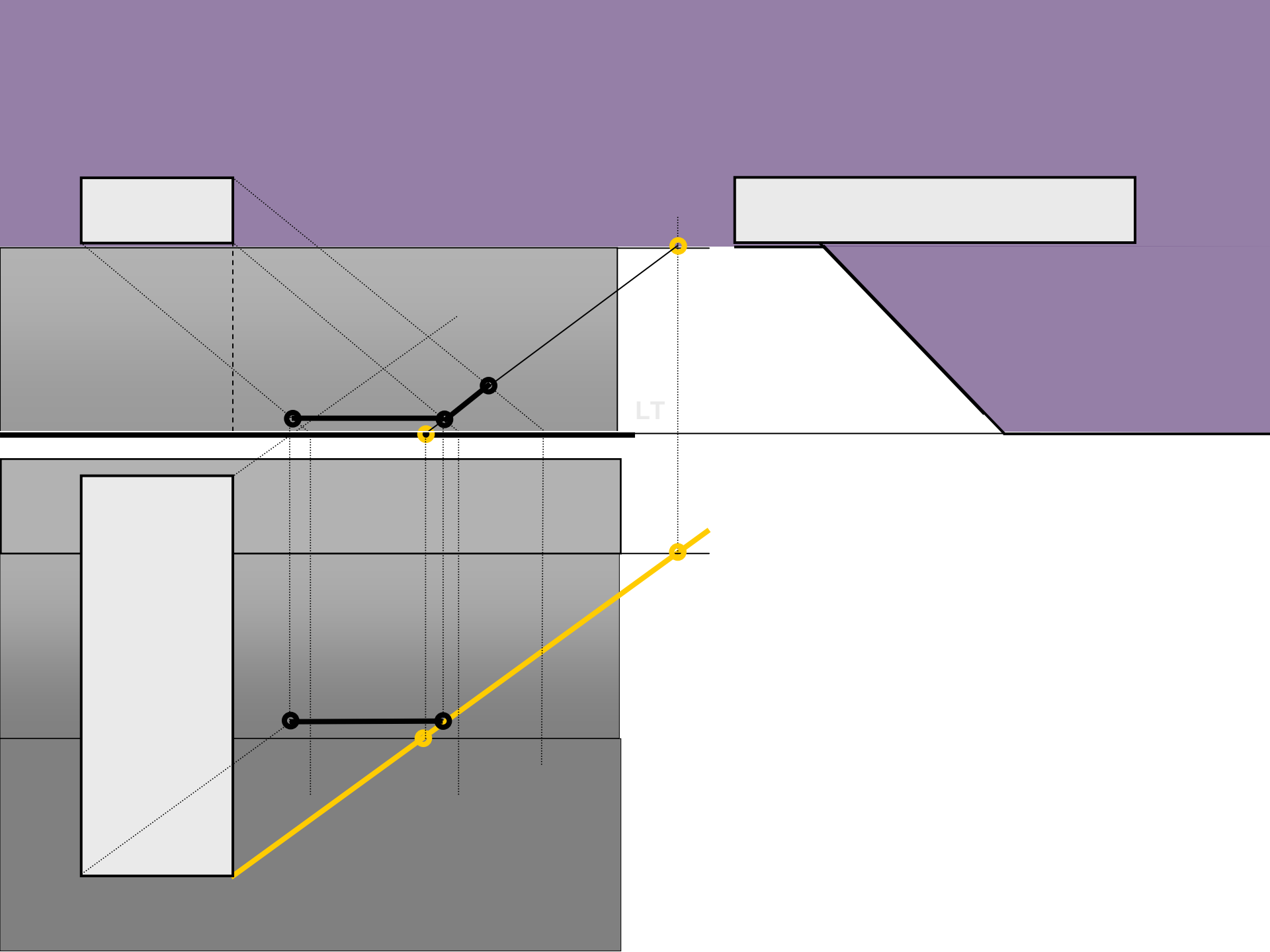

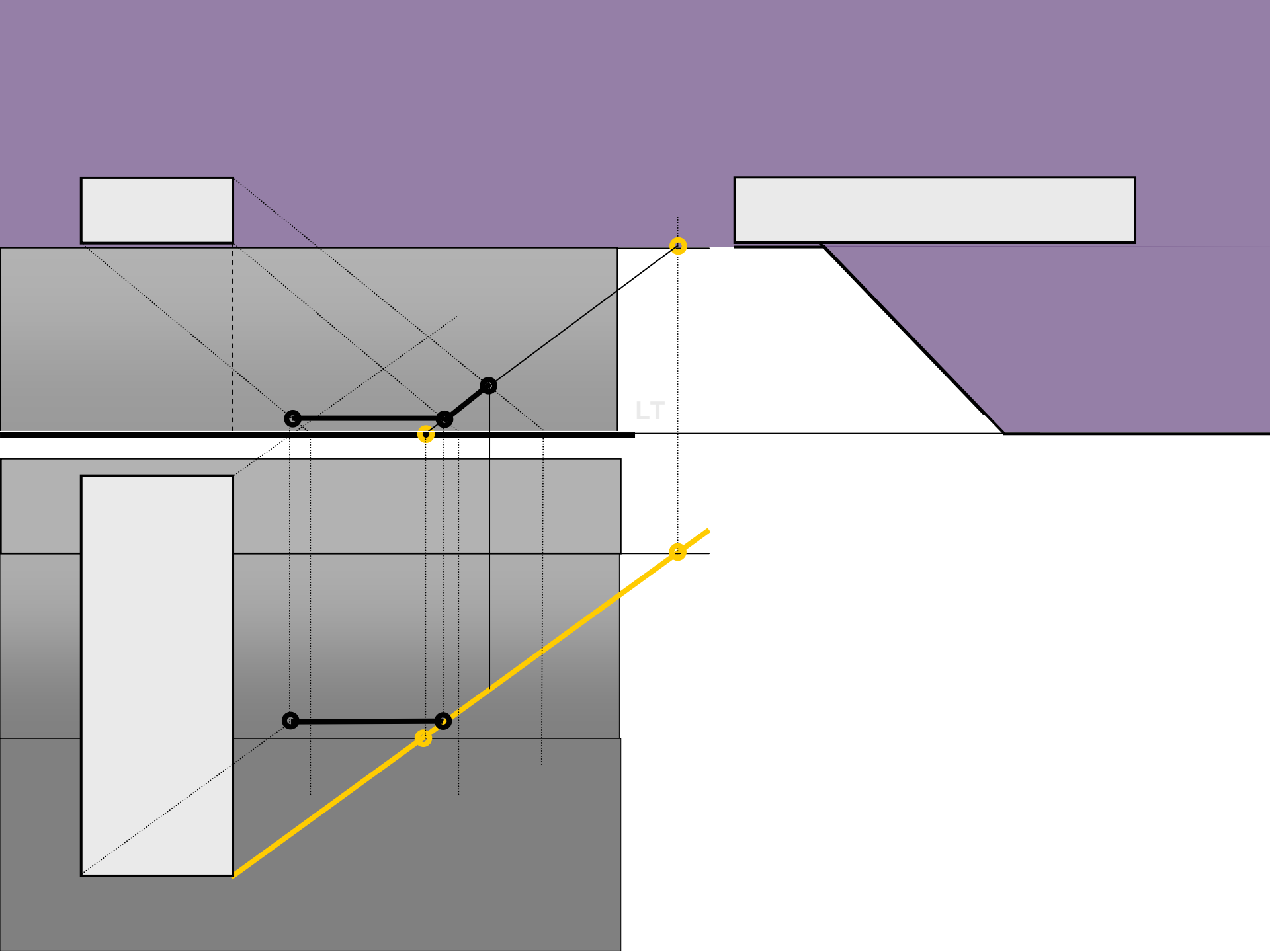

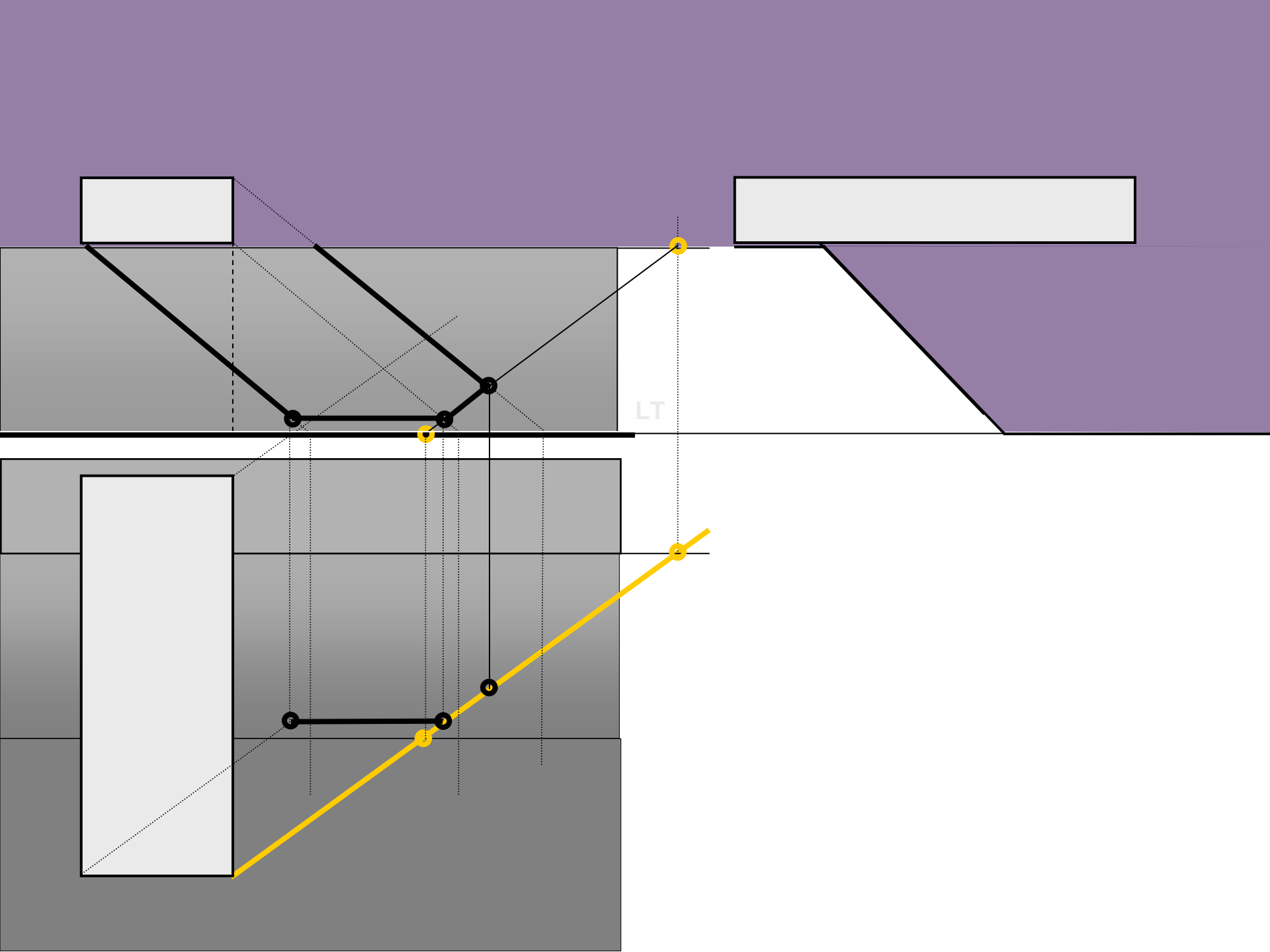

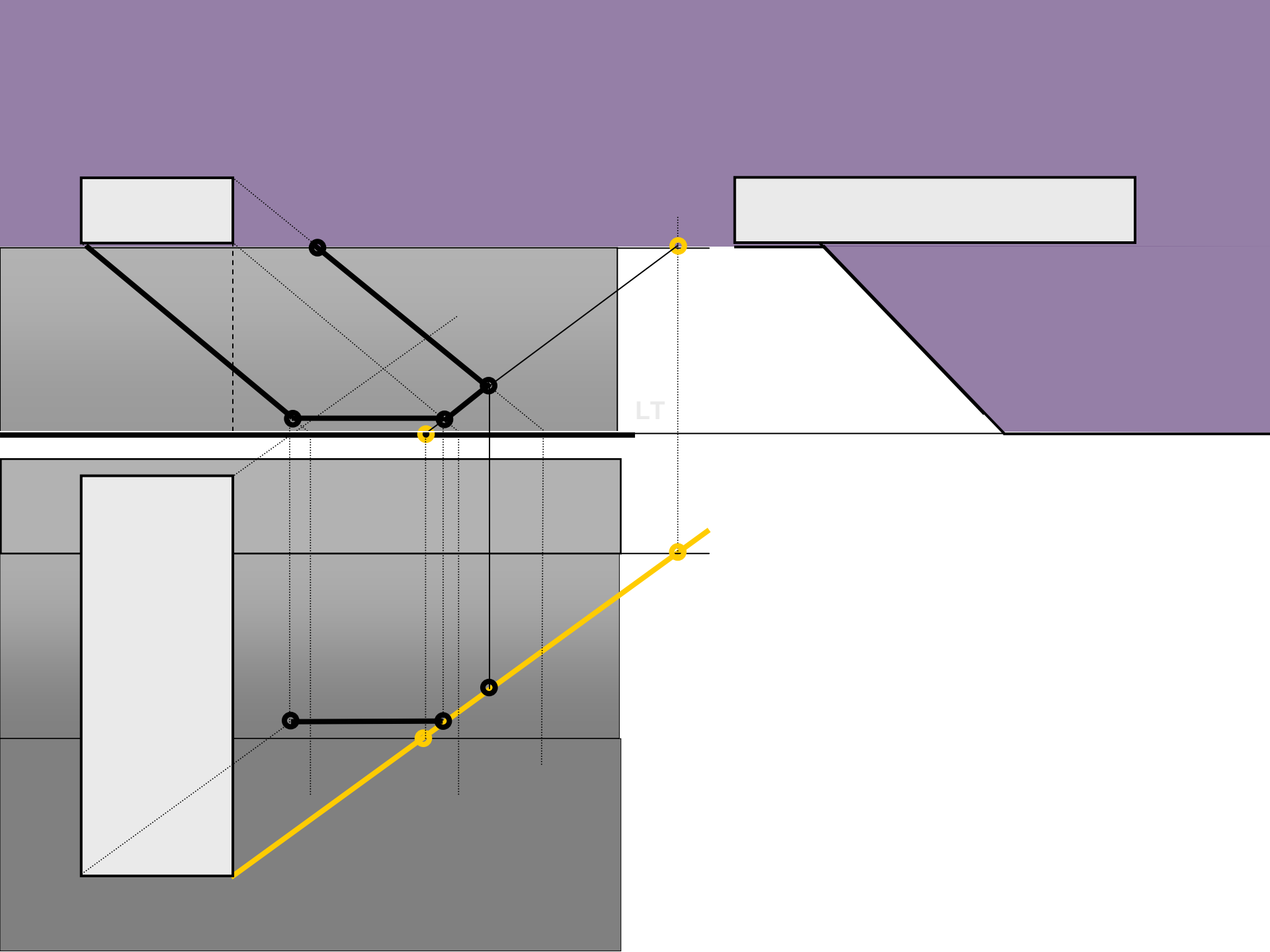

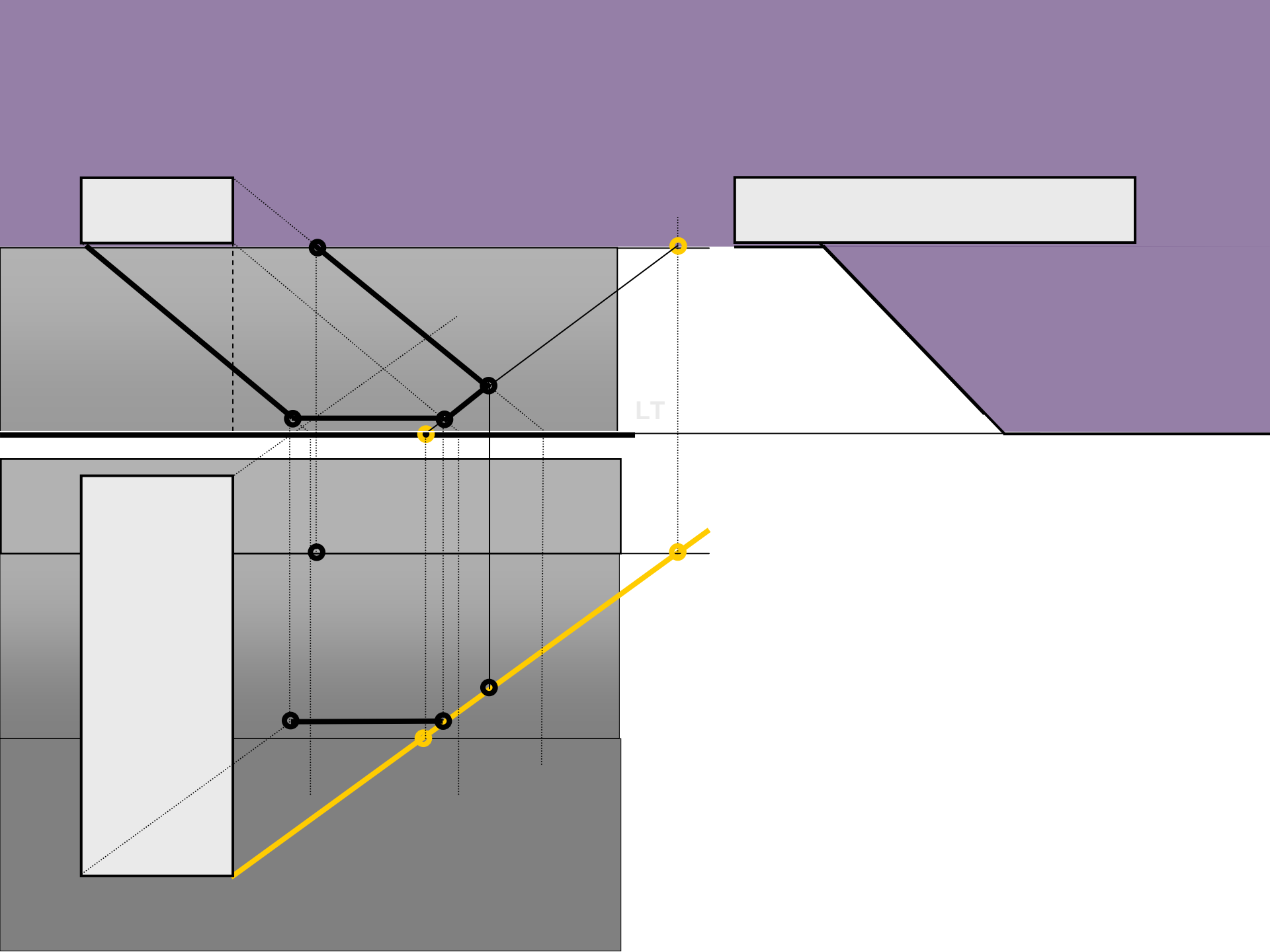

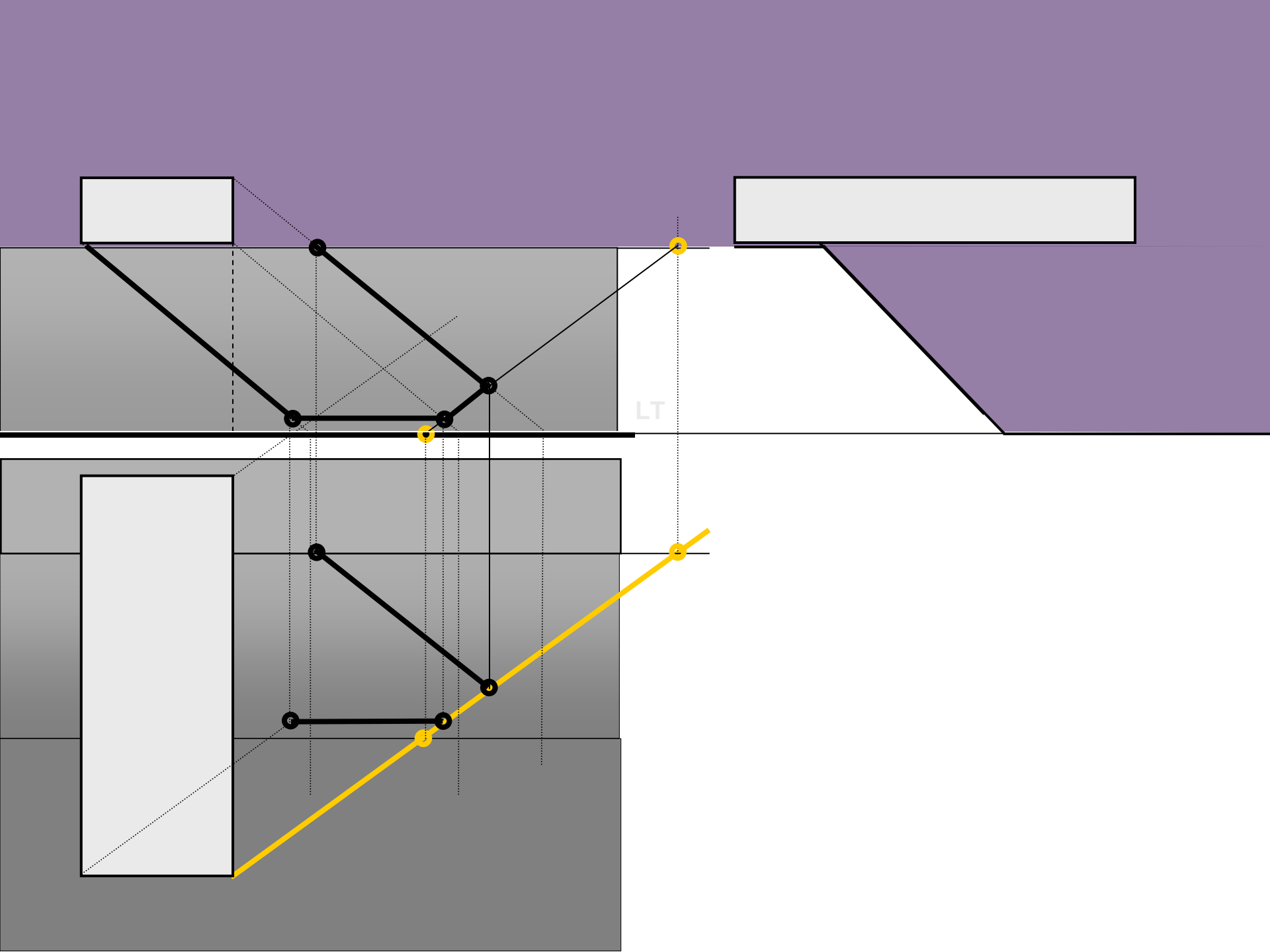

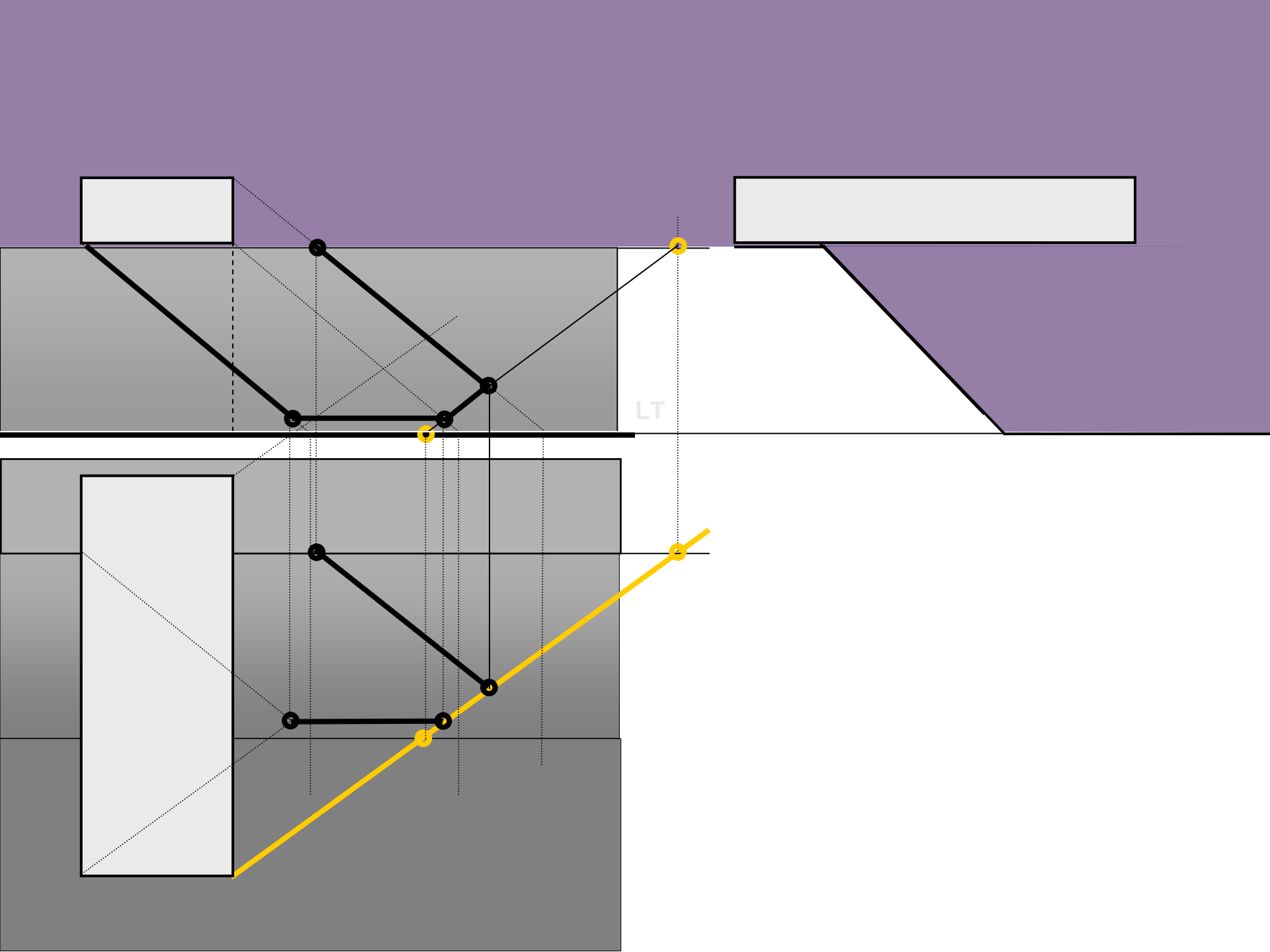

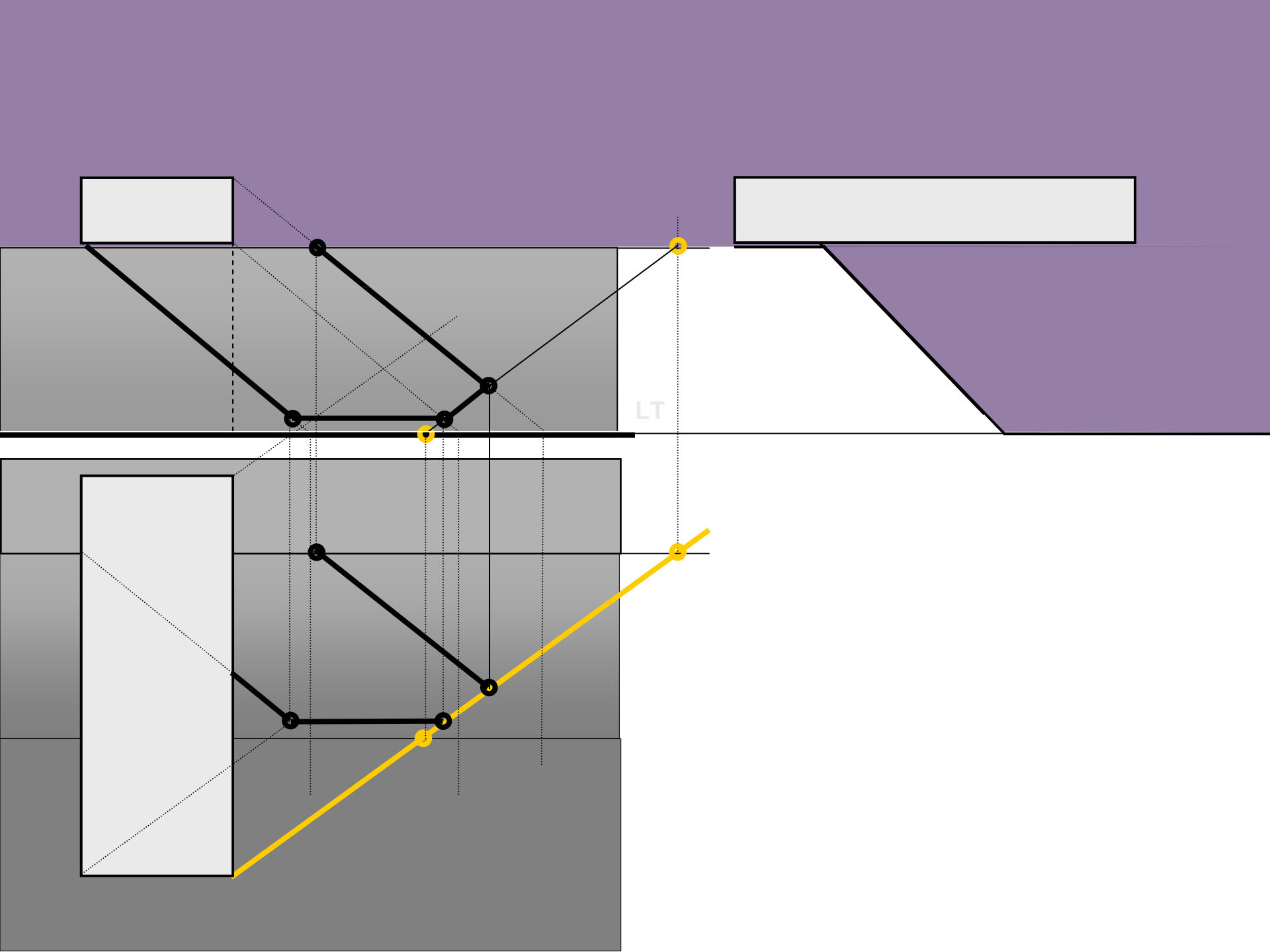

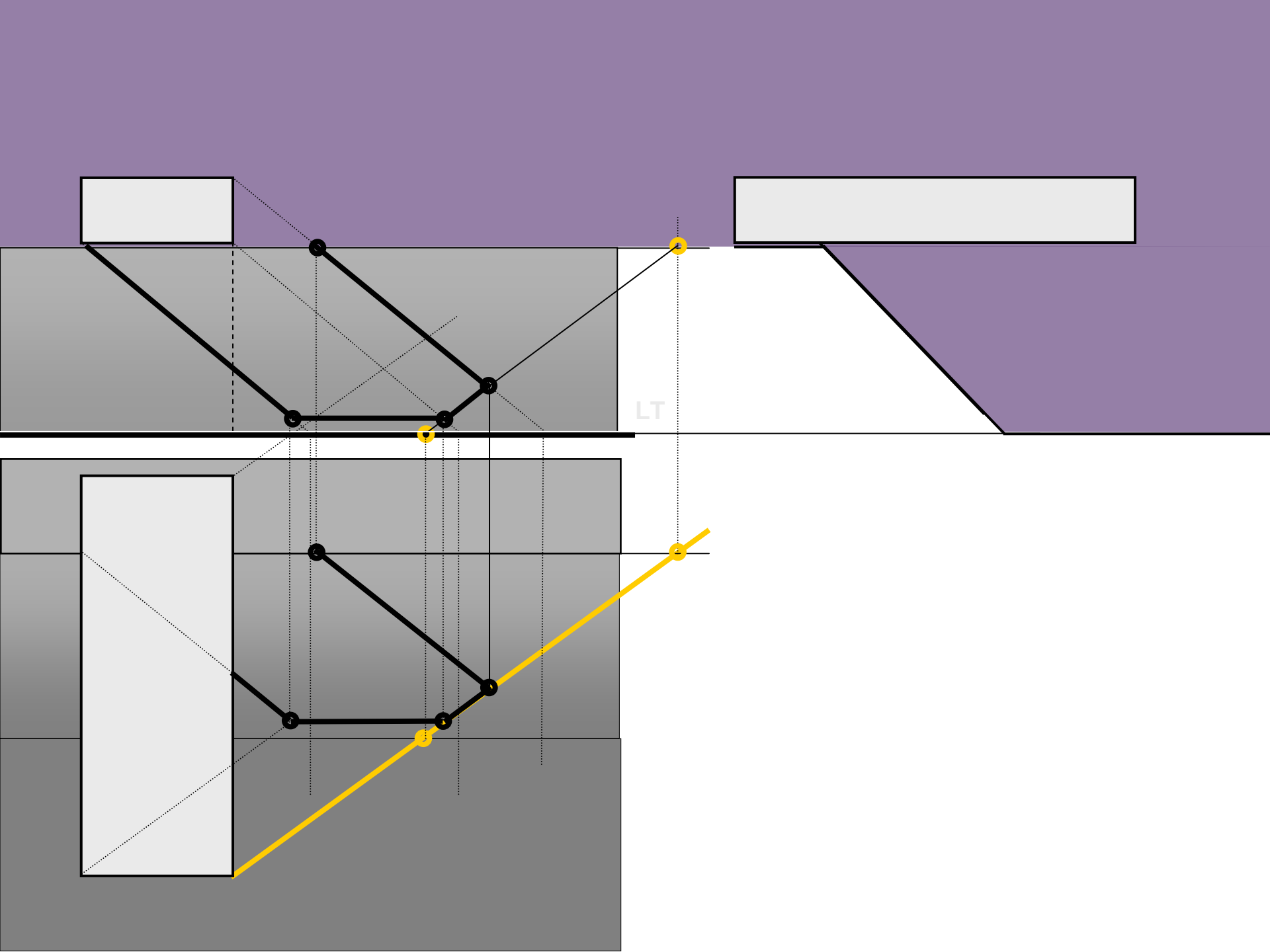

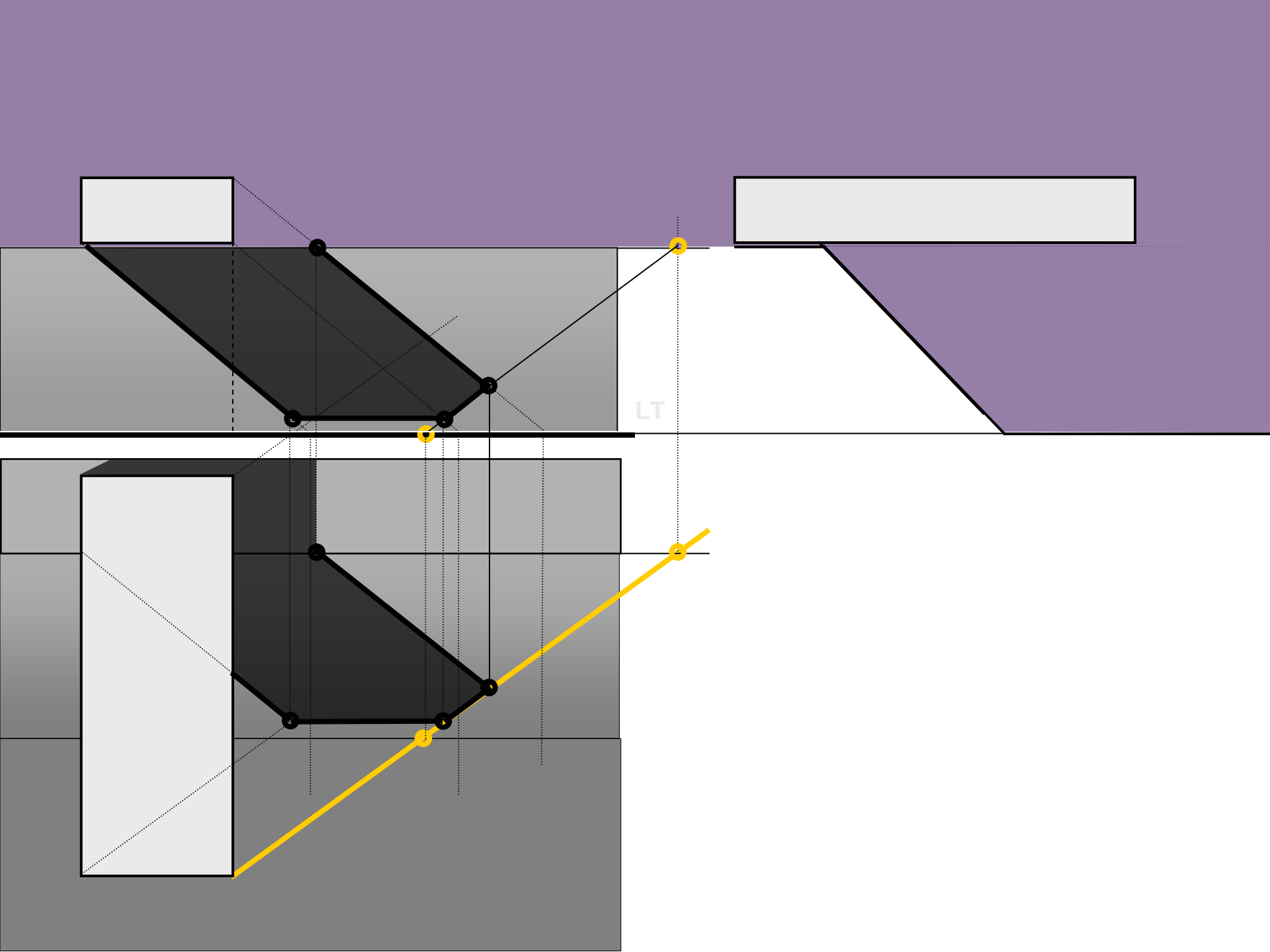

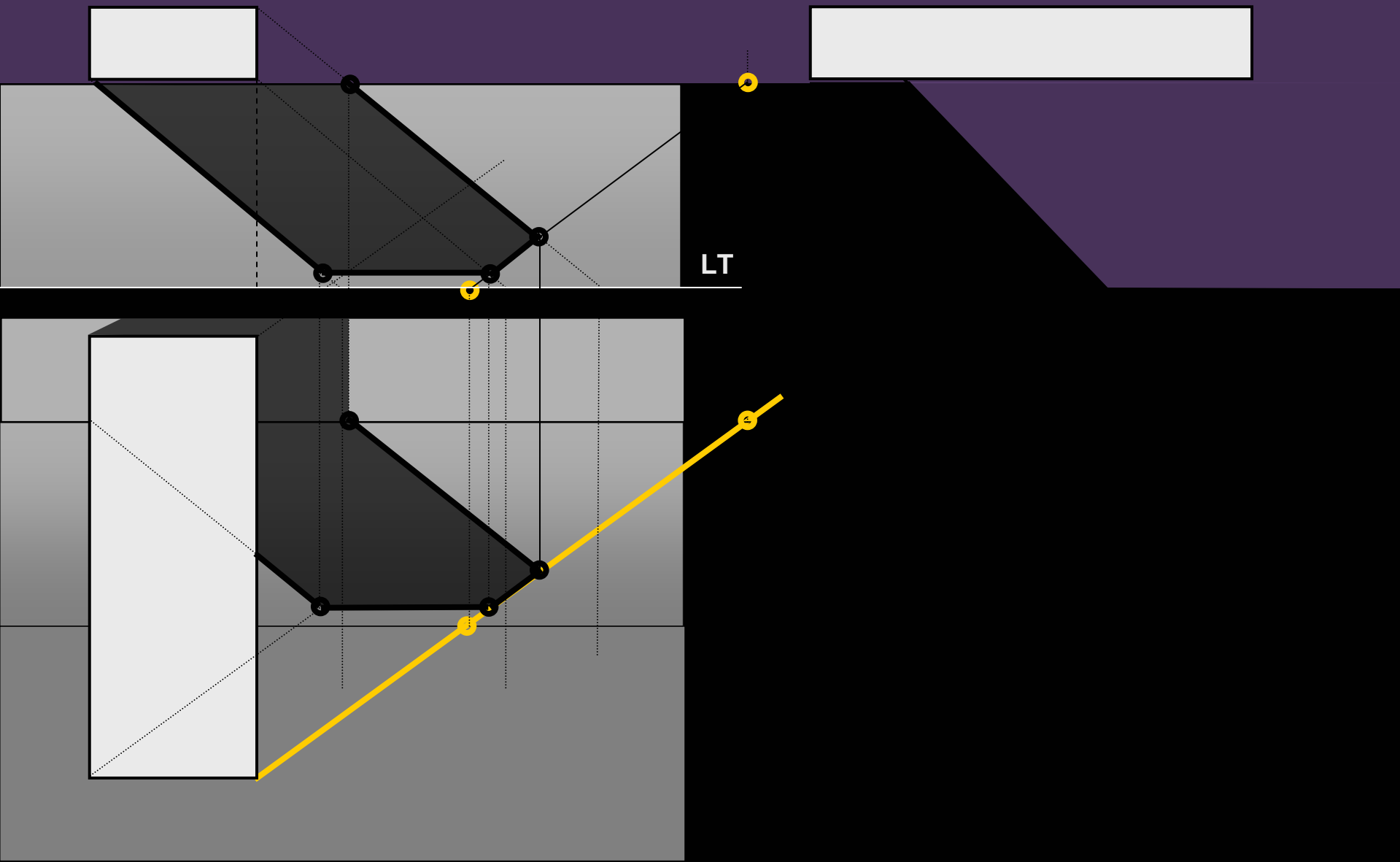

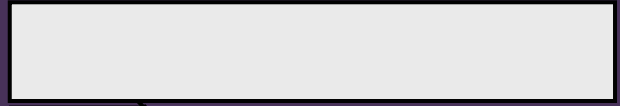
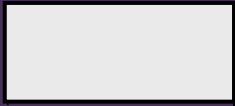
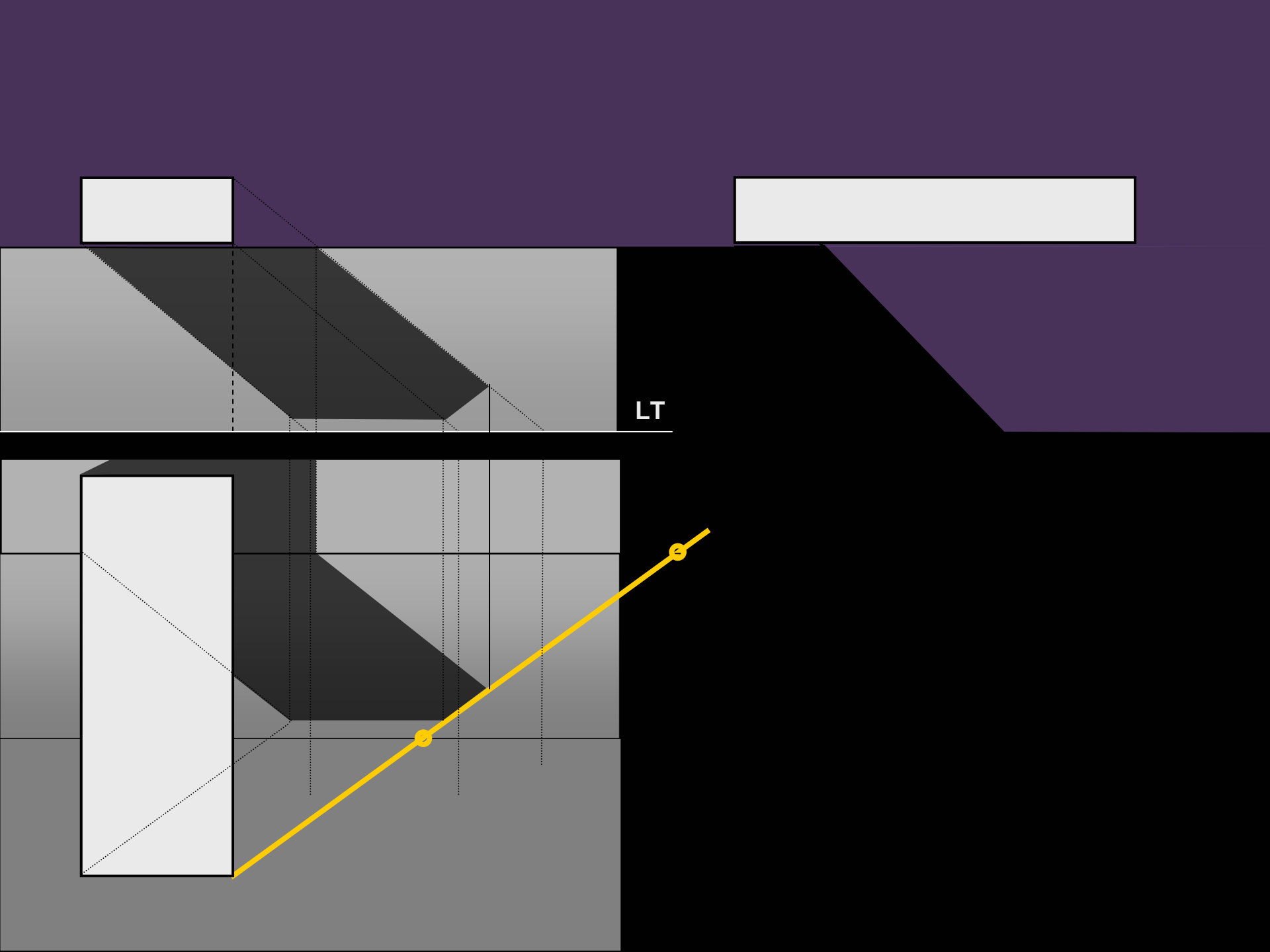

LT

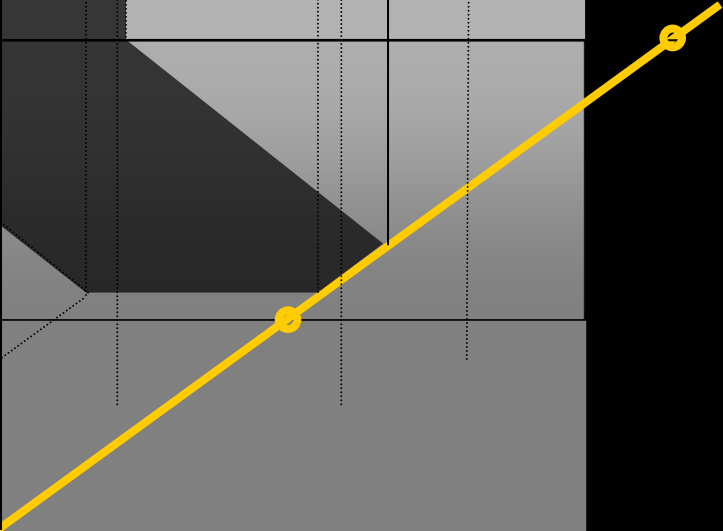
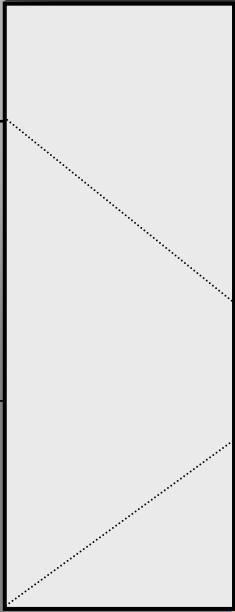

FIN