

ESTRUCTURAS DE CABLES FUNICULARES CONDICIONADAS

**ESTABILIDAD DE LAS CONSTRUCCIONES I
FACULTAD DE ARQUITECTURA, UDELAR.**

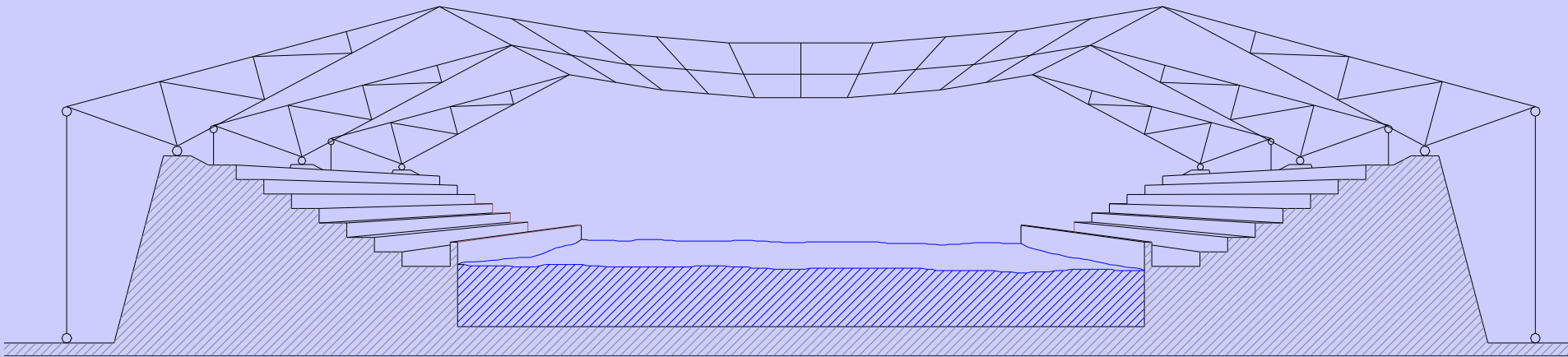

PISCINA CUBIERTA

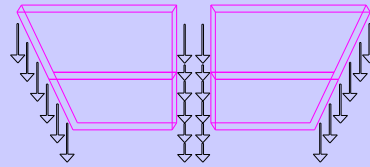

LOSETAS

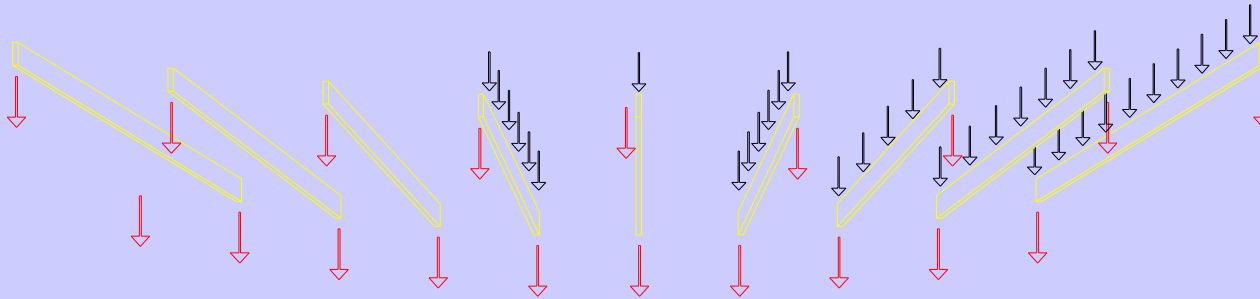

PERFILES

CABLES

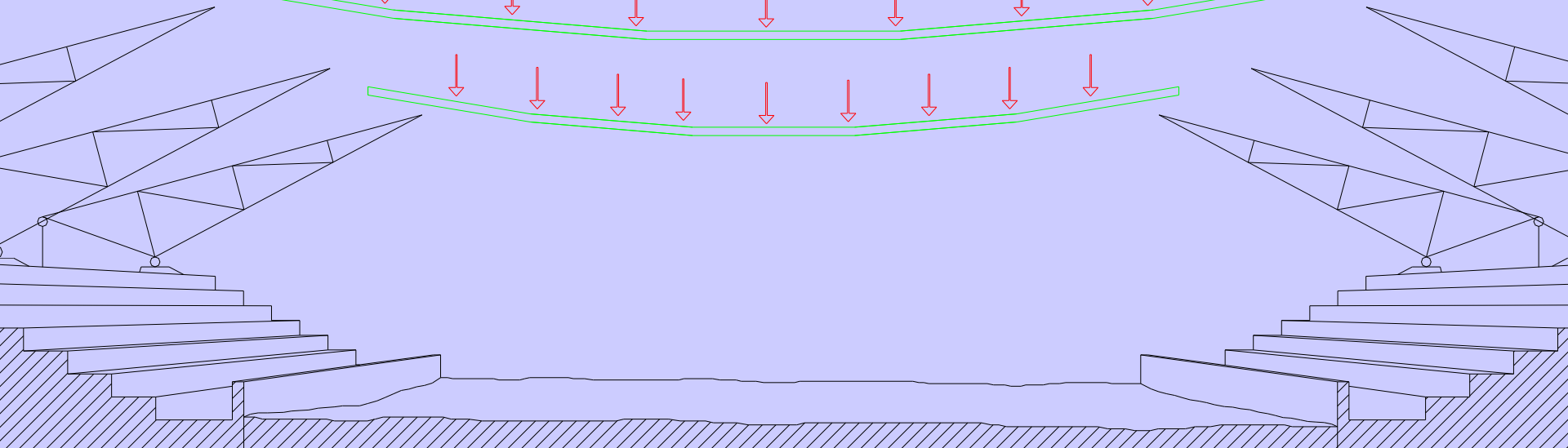
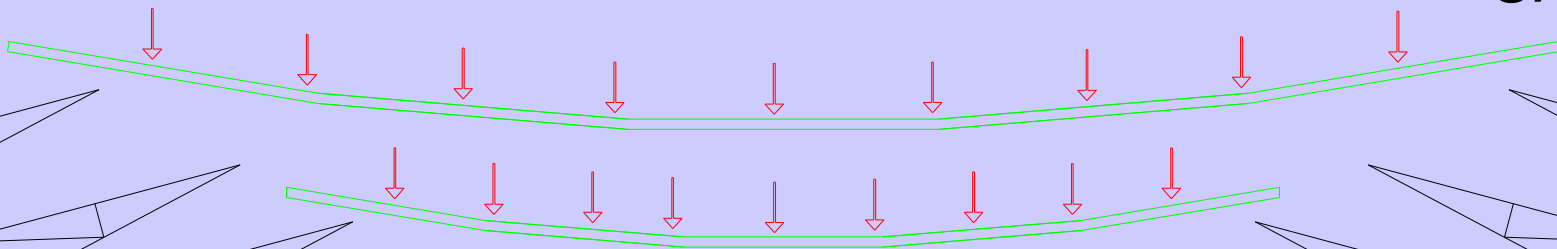

MODELO FUNCIONAL

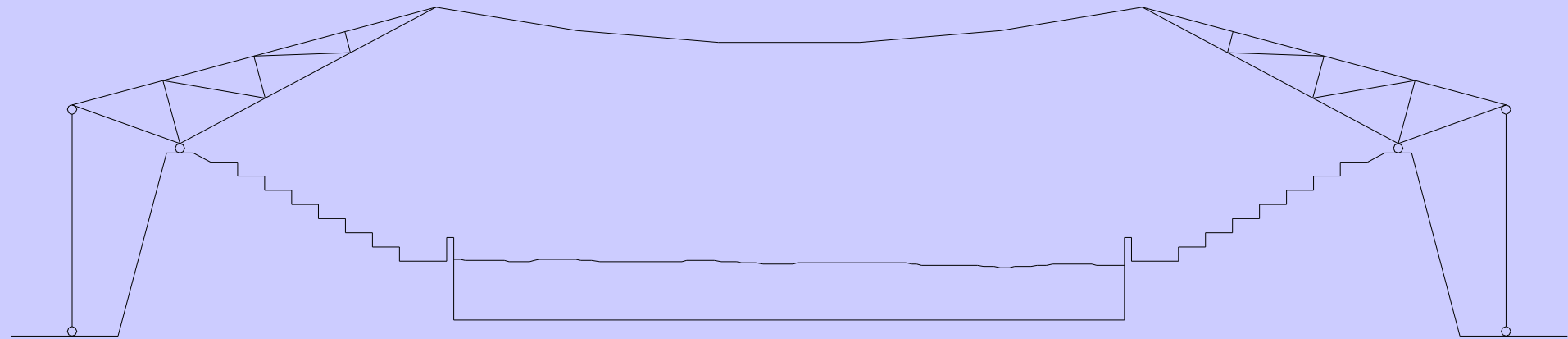

ESQUEMA

PLANO DE SITUACIÓN

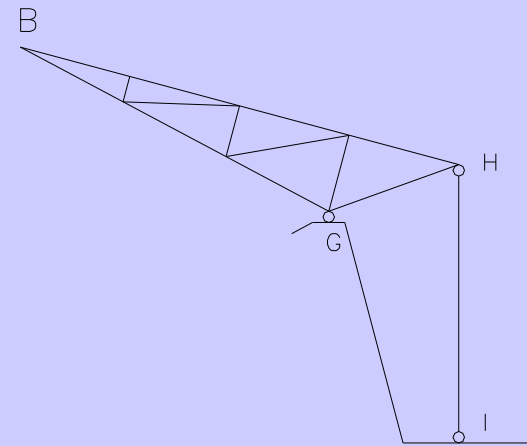
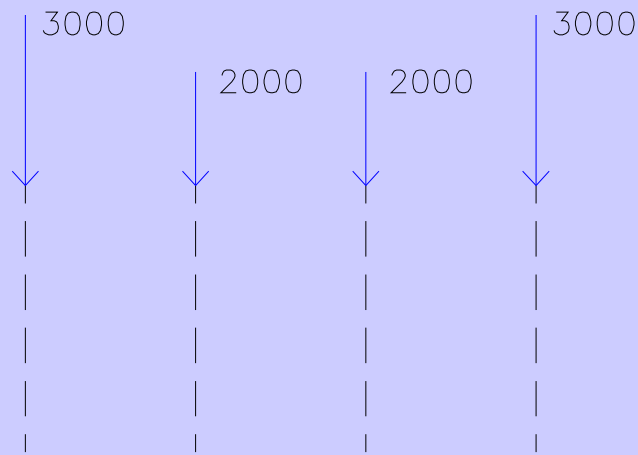
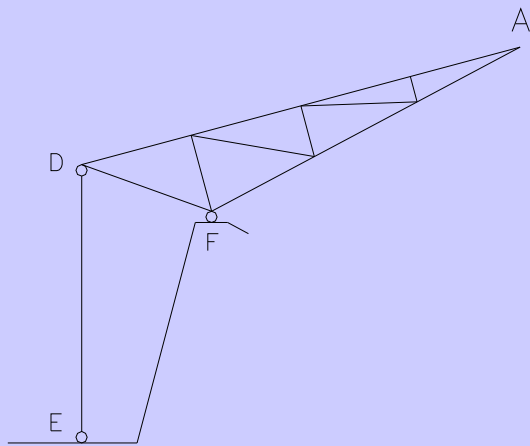

MODELO DE ACCIONES

PLANO DE SITUACIÓN

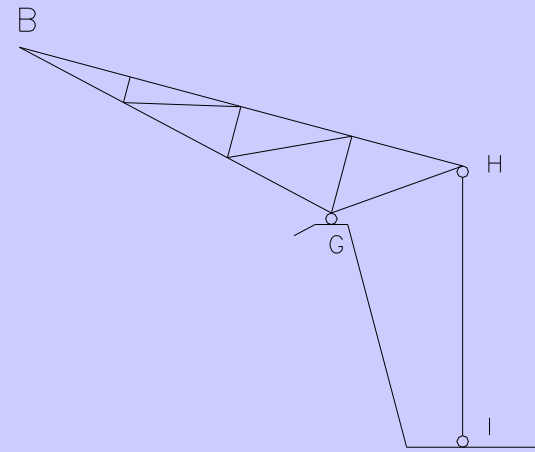
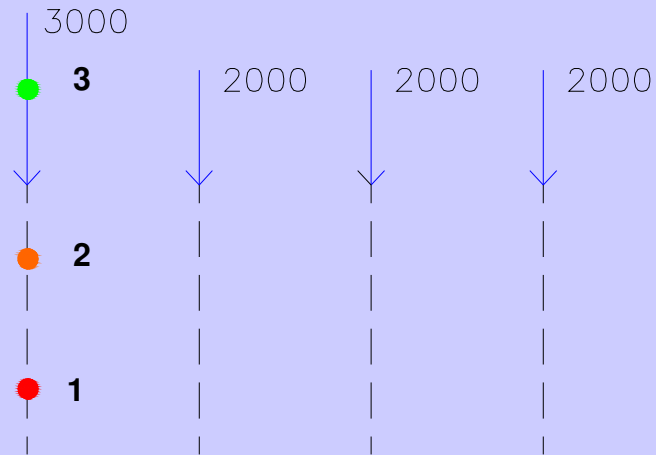
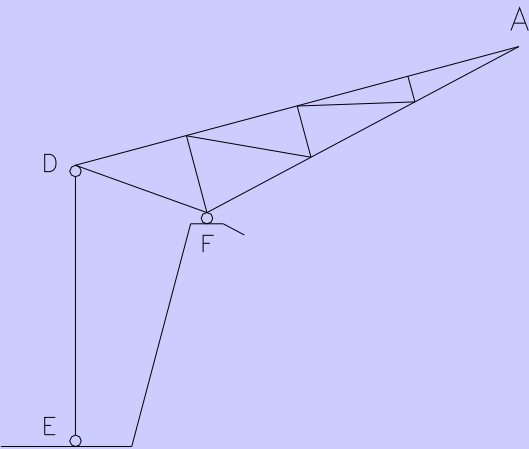

PLANO DE SITUACIÓN

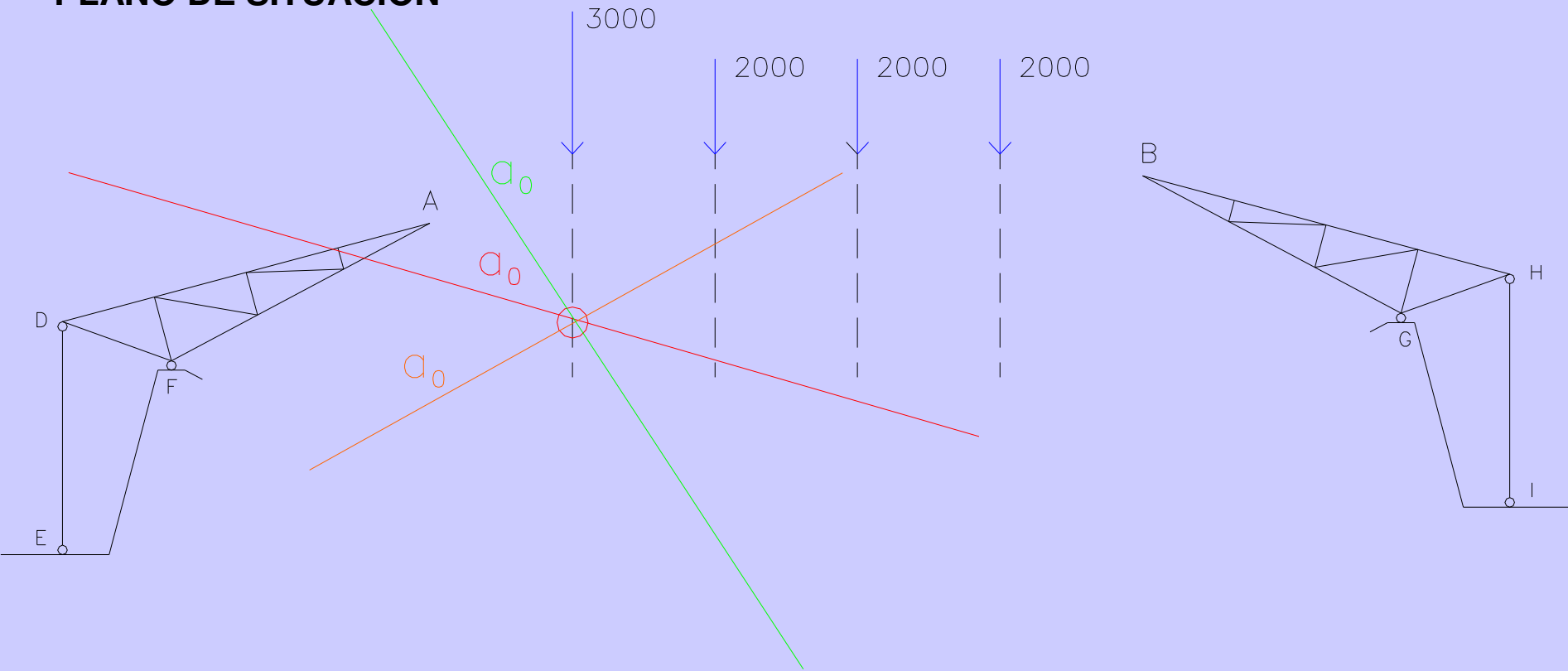

PLANO OPERATORIO

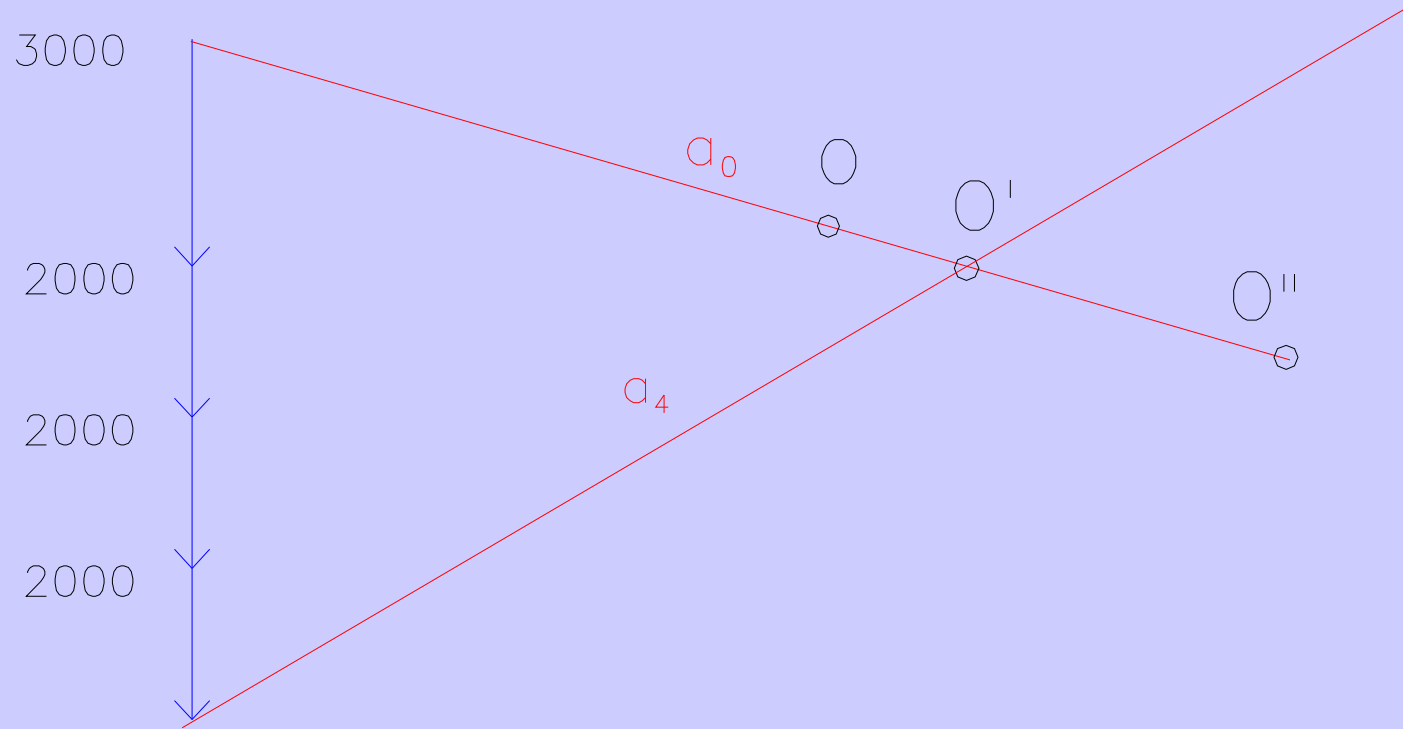

PLANO OPERATORIO

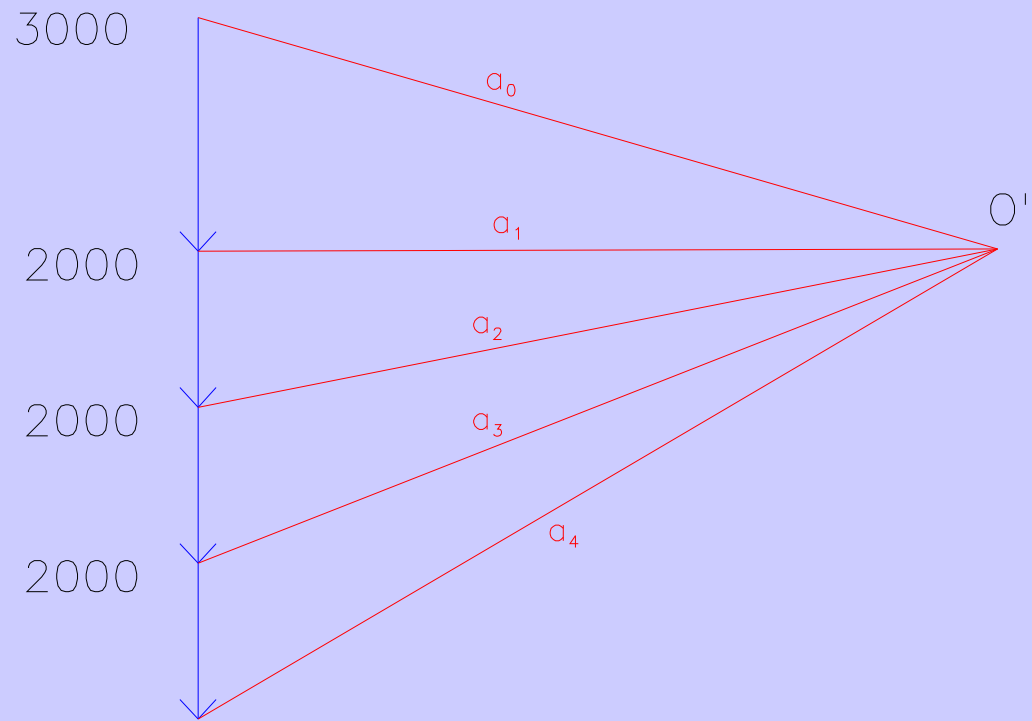

PLANO DE SITUACIÓN

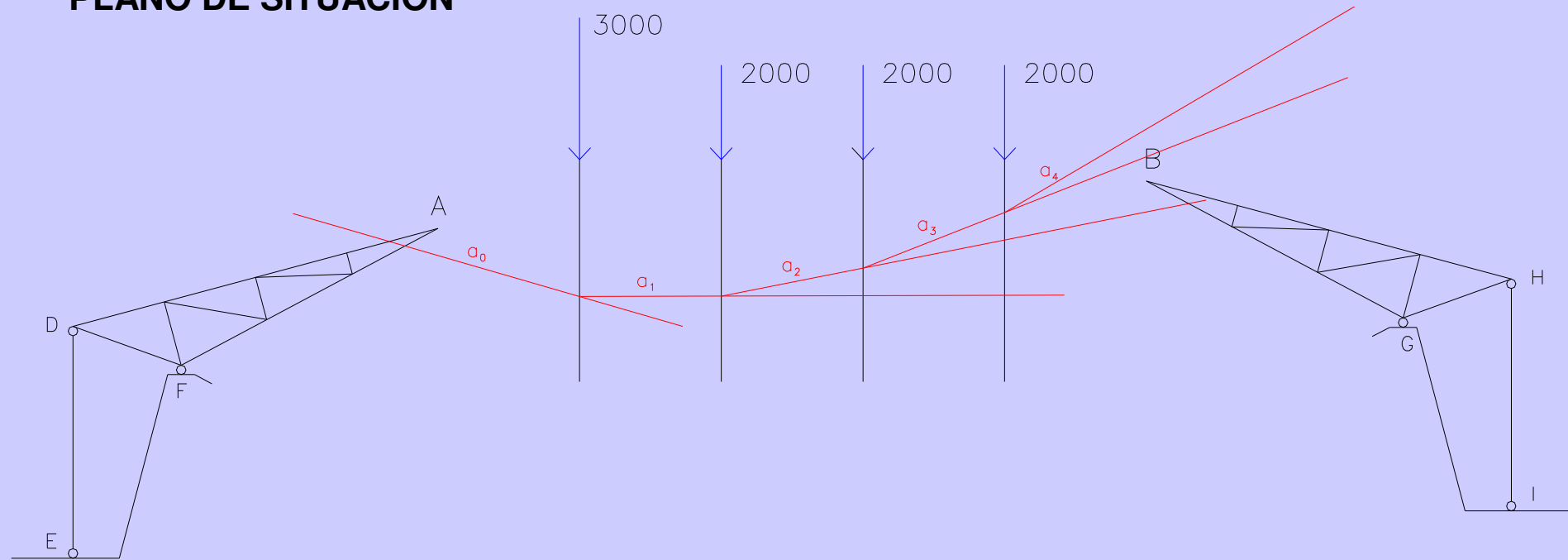

PLANO DE SITUACIÓN

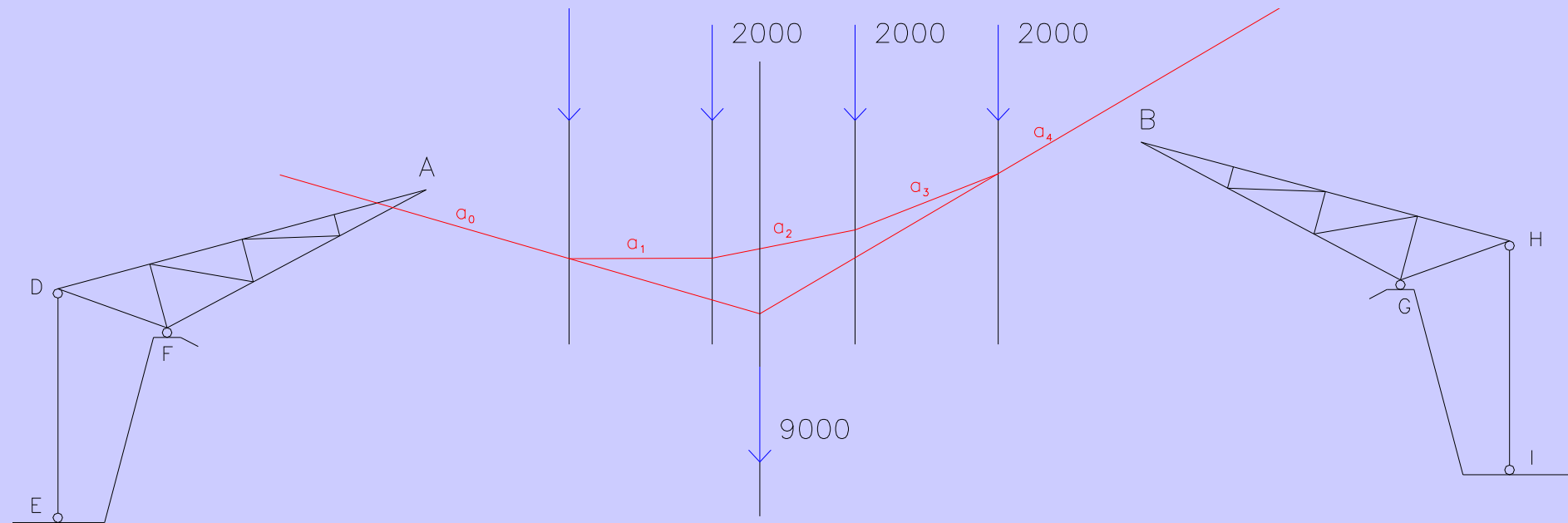

PLANO DE SITUACIÓN

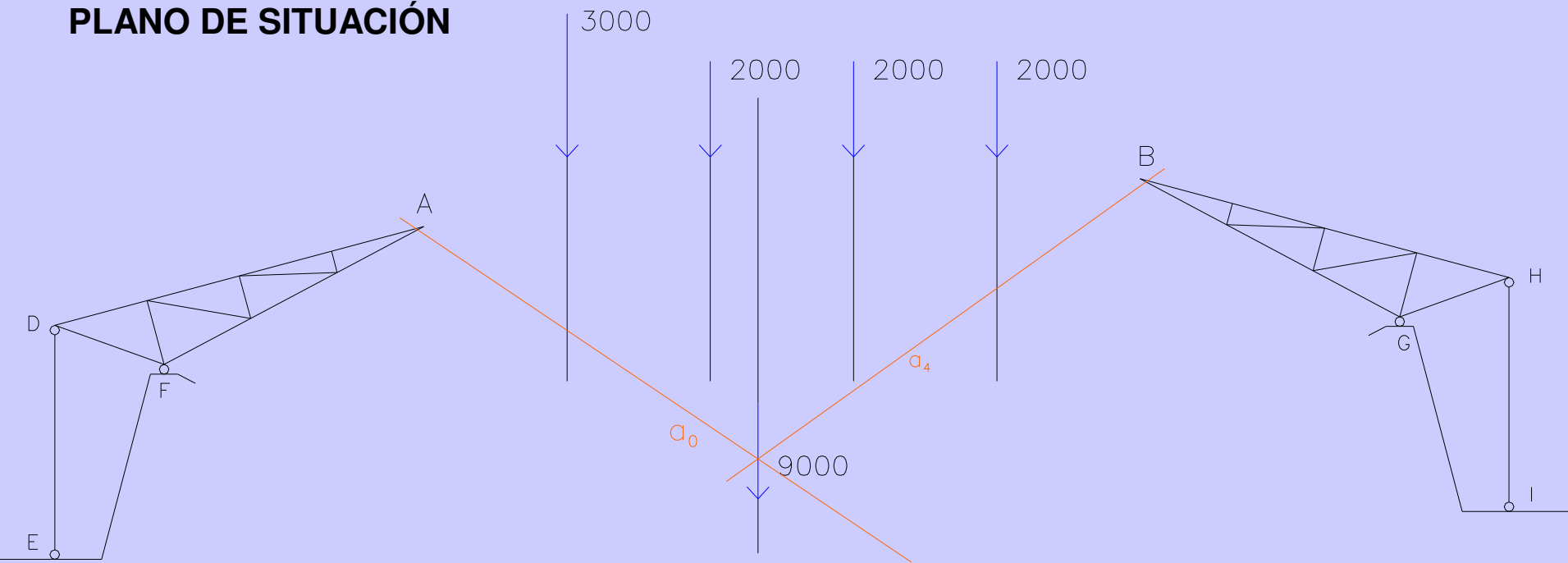

FUNICULAR POR 2 PUNTOS A Y B

PLANO DE SITUACIÓN

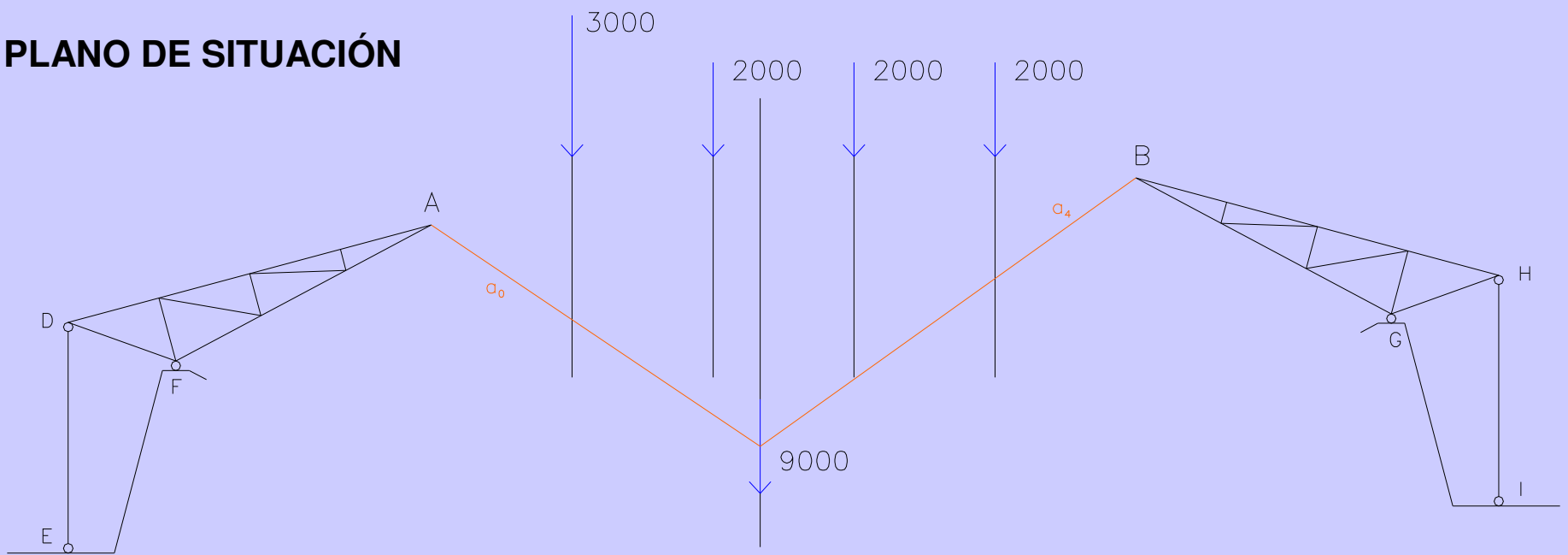

PLANO OPERATORIO

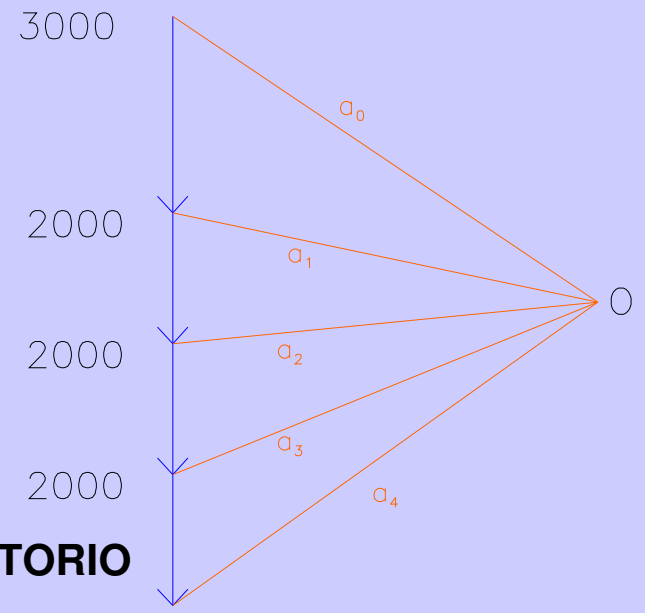

PLANO DE SITUACIÓN

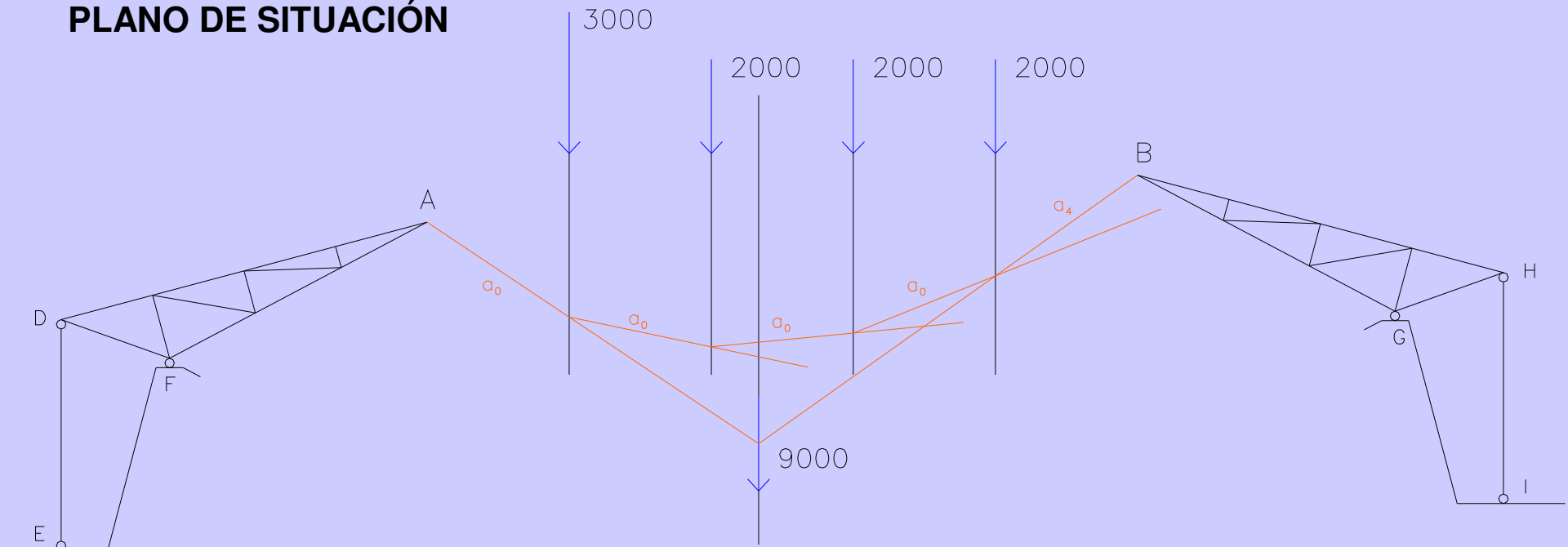

PLANO DE SITUACIÓN

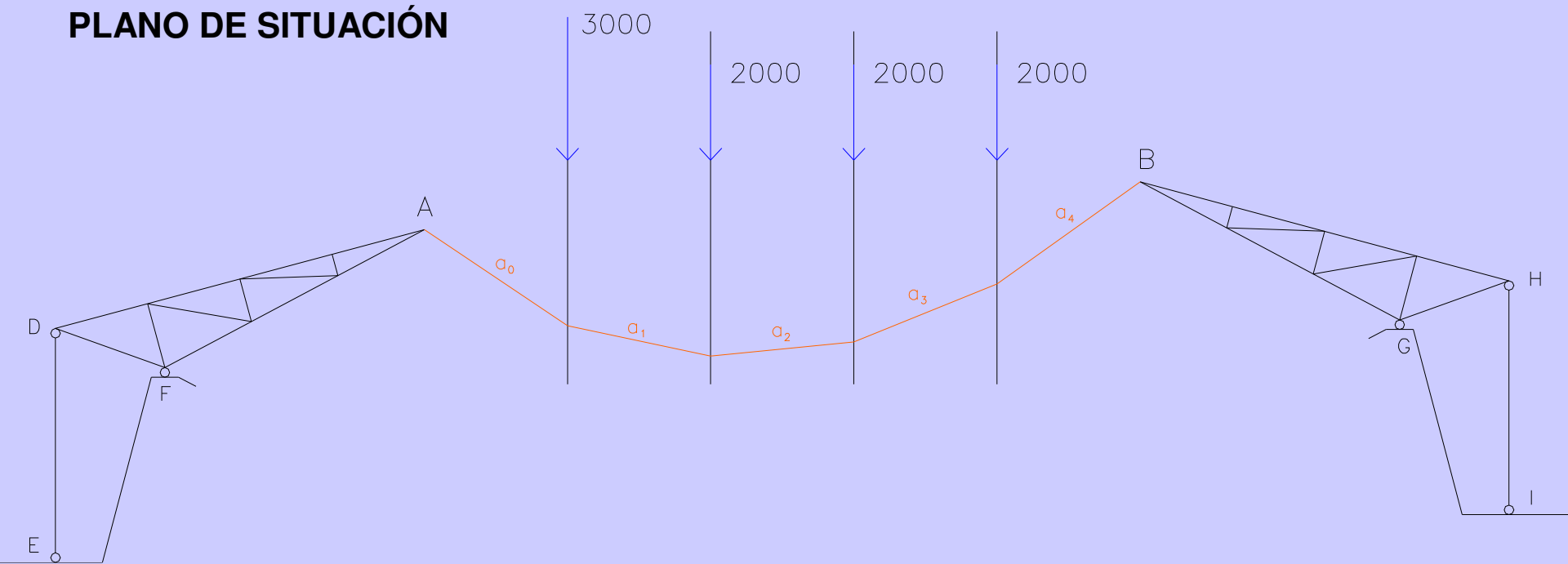

PLANO DE SITUACIÓN

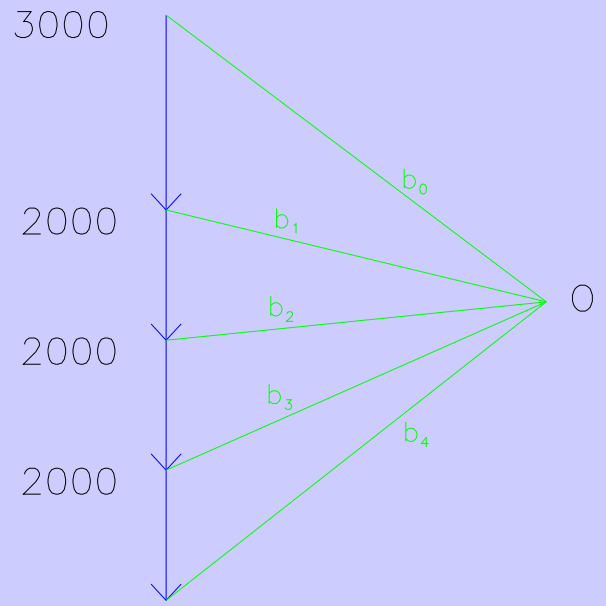
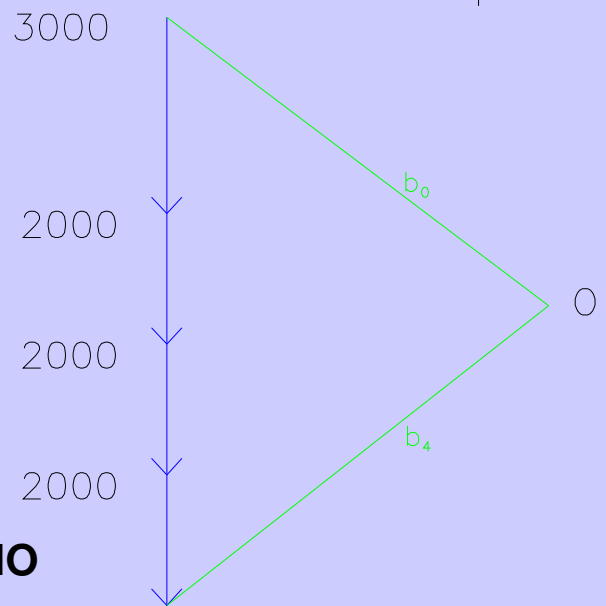
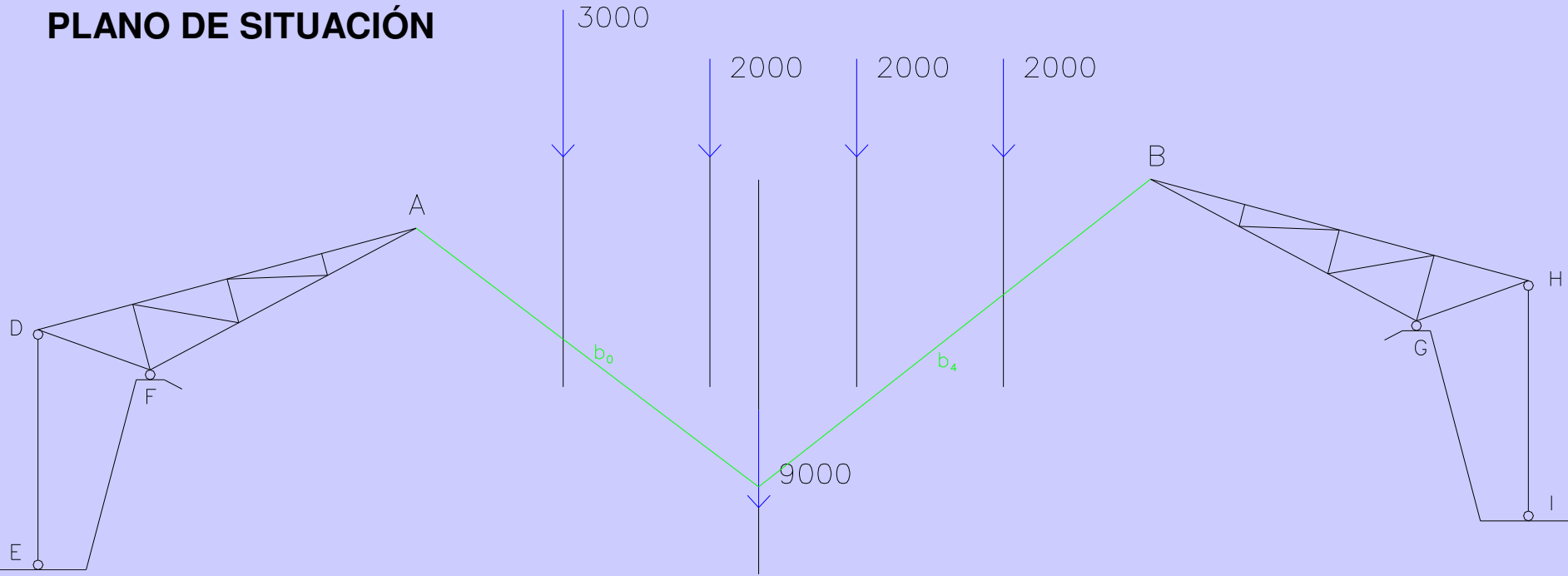

PLANO OPERATORIO

PLANO DE SITUACIÓN

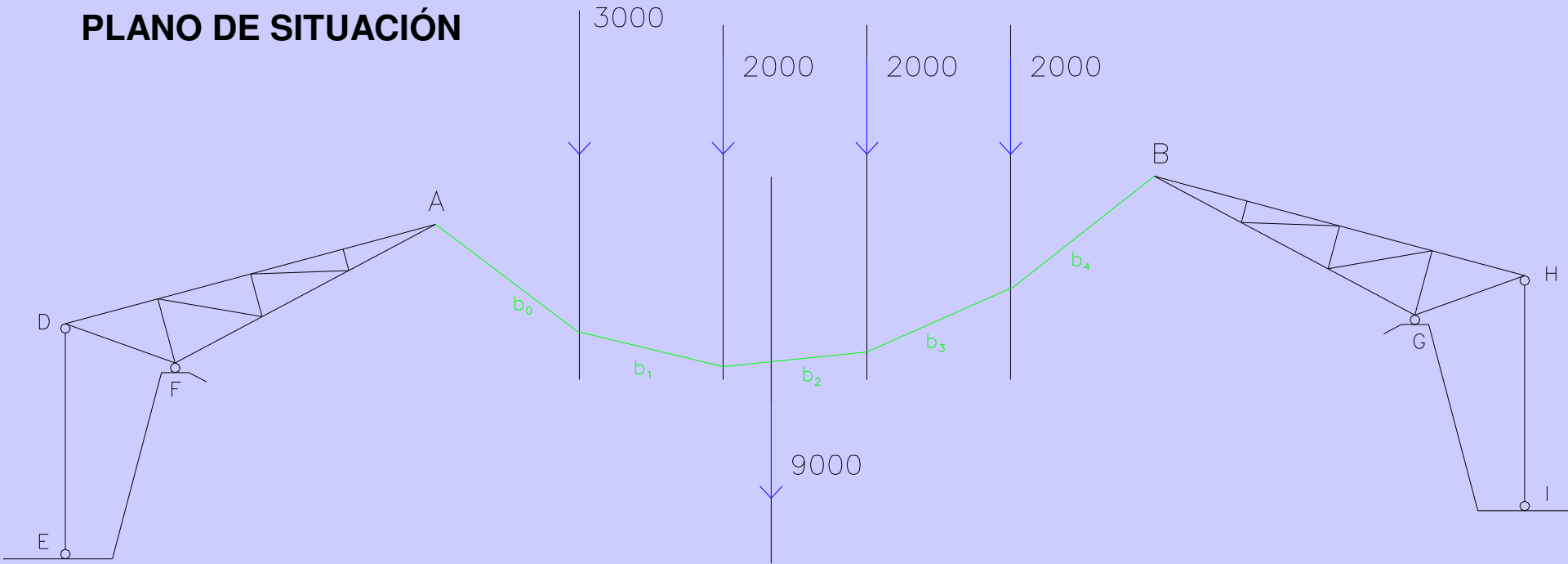

PLANO DE SITUACIÓN

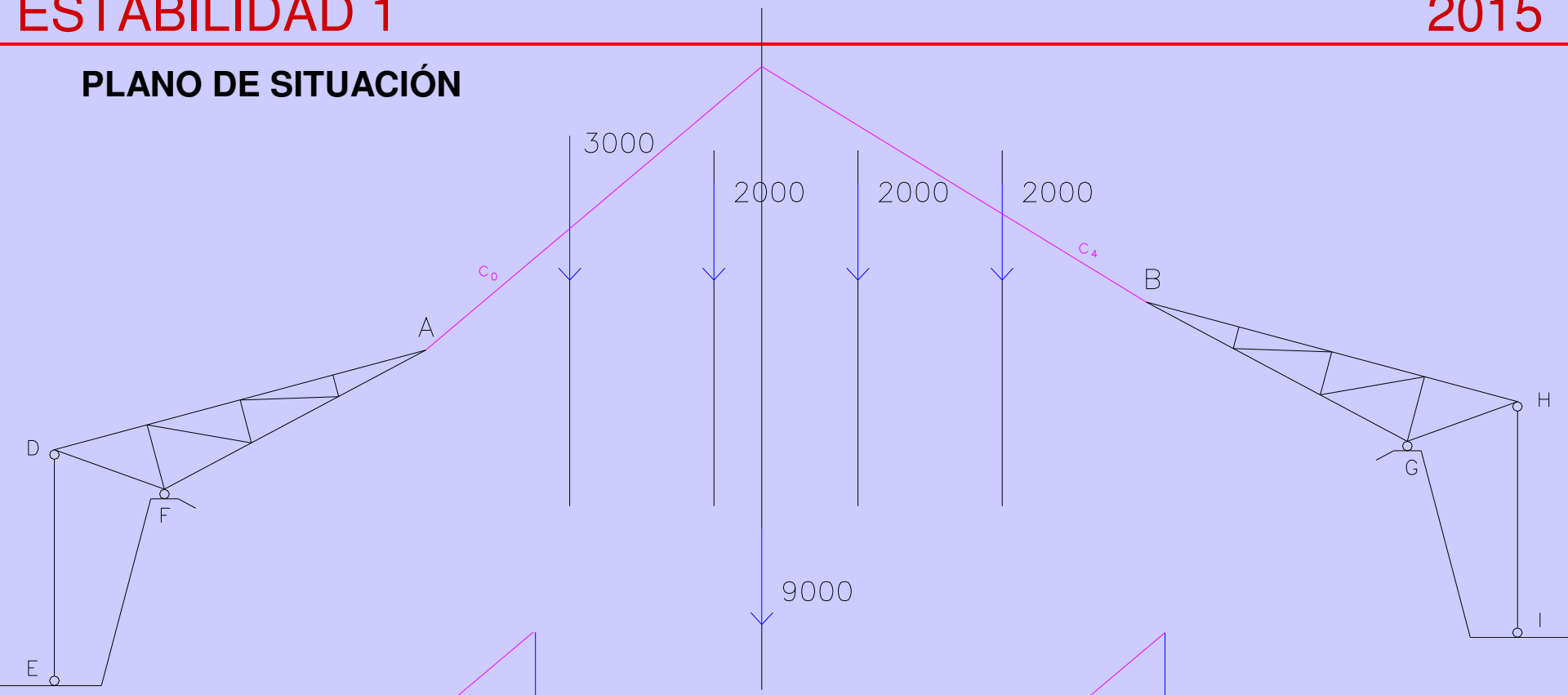

PLANO OPERATORIO

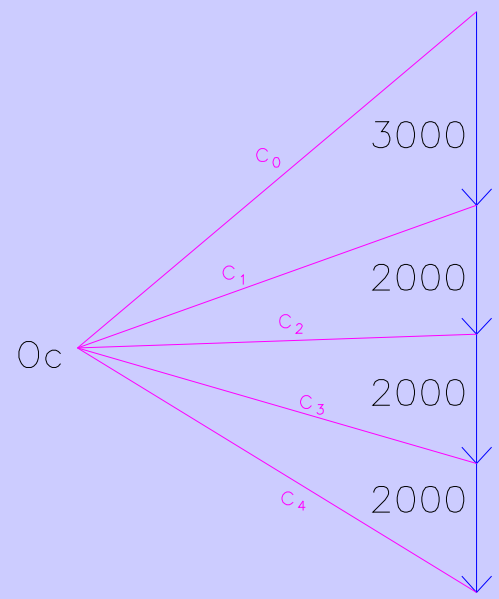
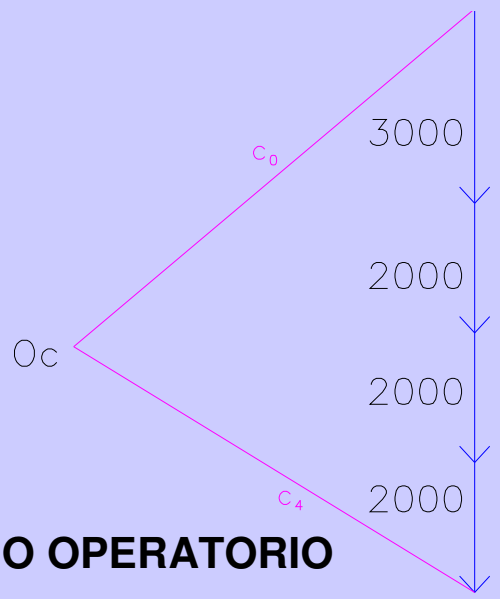

PLANO DE SITUACIÓN

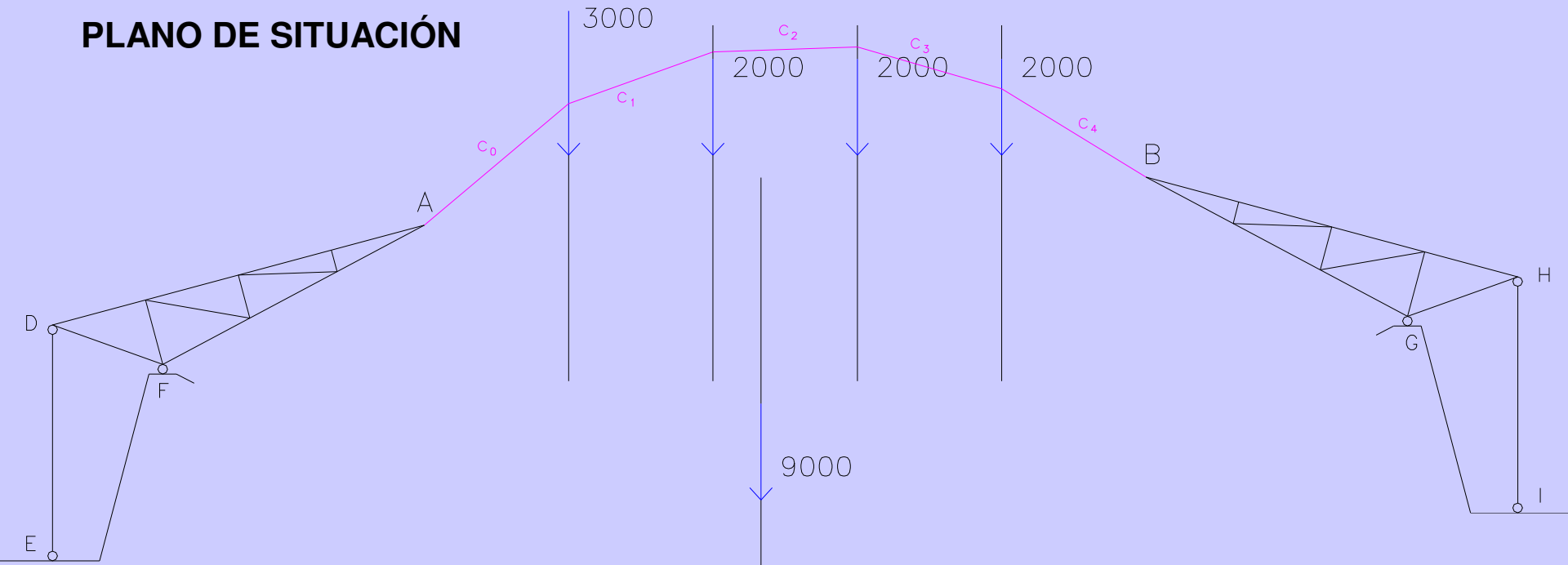

PLANO DE SITUACIÓN

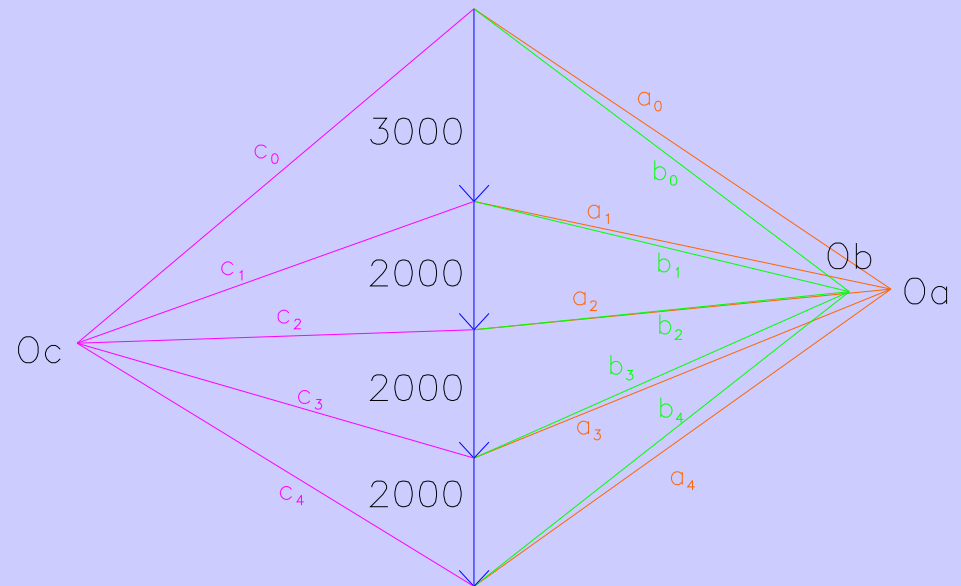
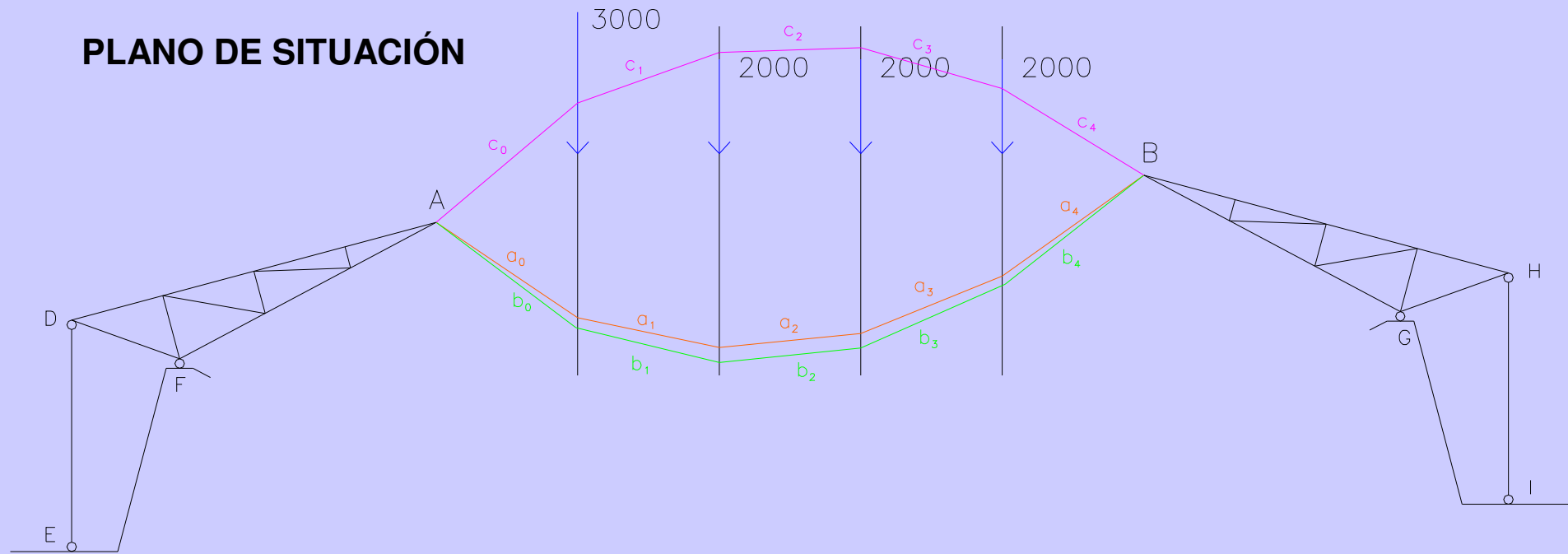

PLANO OPERATORIO

PLANO DE SITUACIÓN

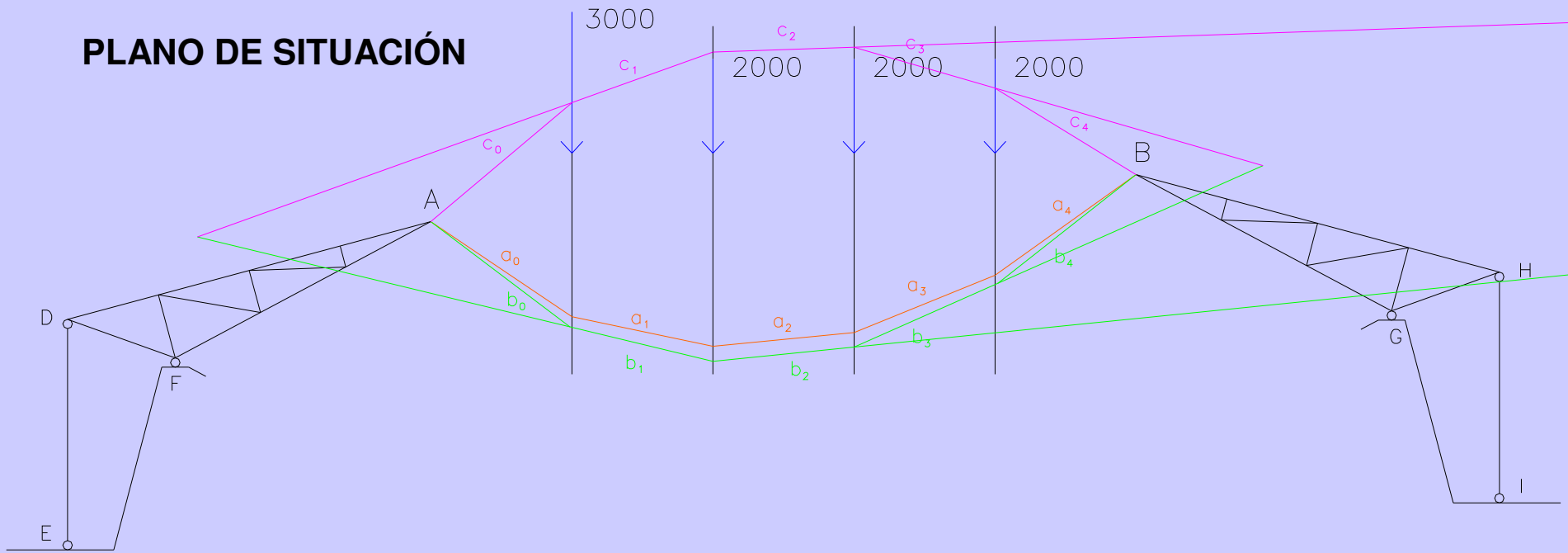

PLANO OPERATORIO

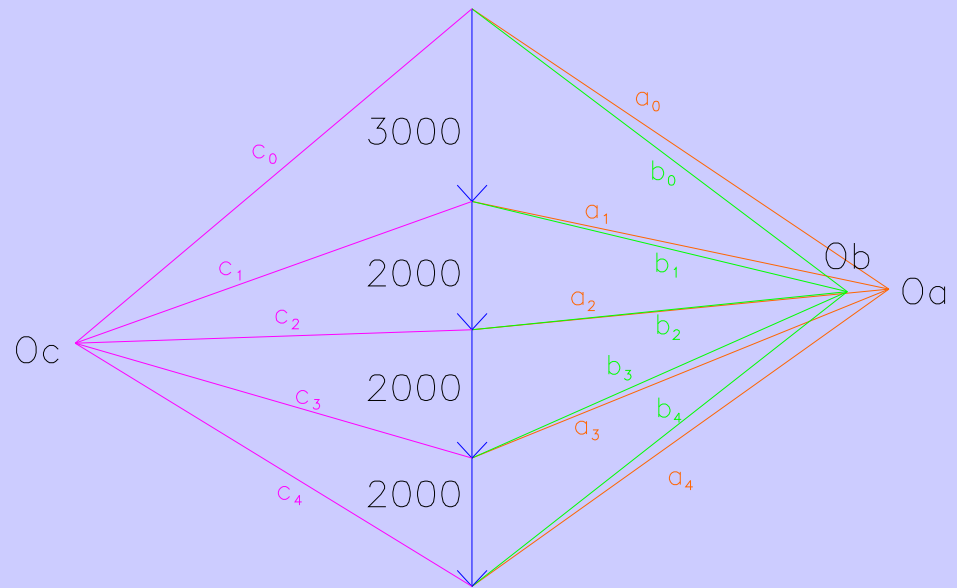

PLANO DE SITUACIÓN

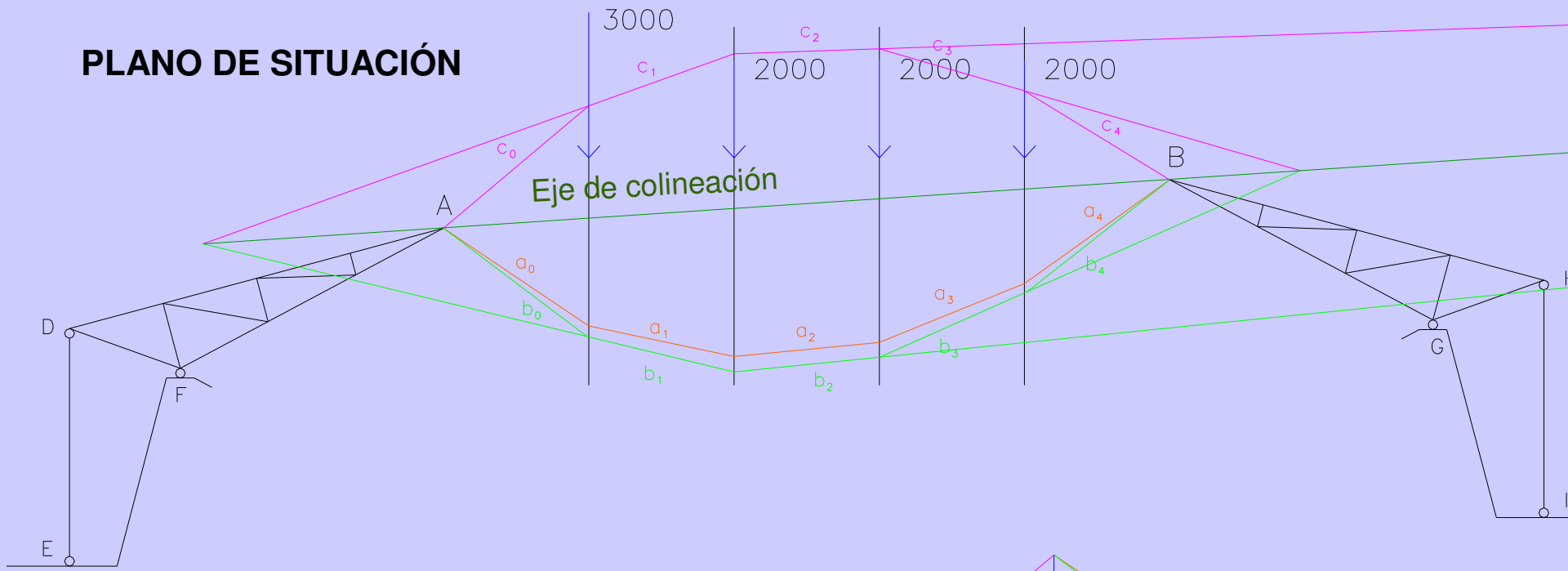

PLANO OPERATORIO

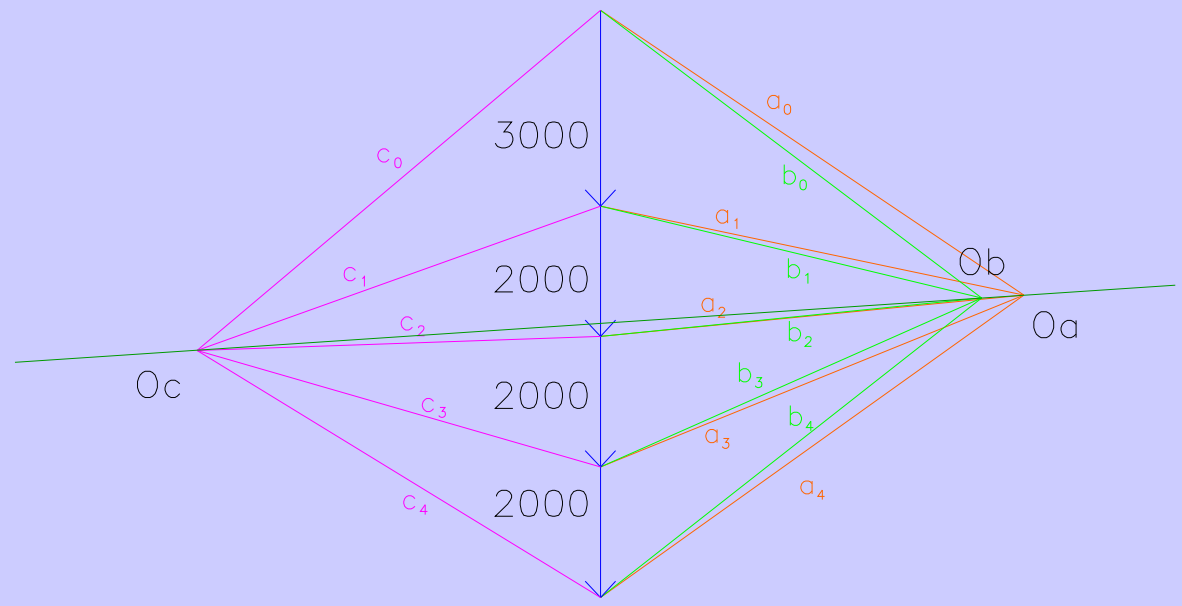

PLANO DE SITUACIÓN

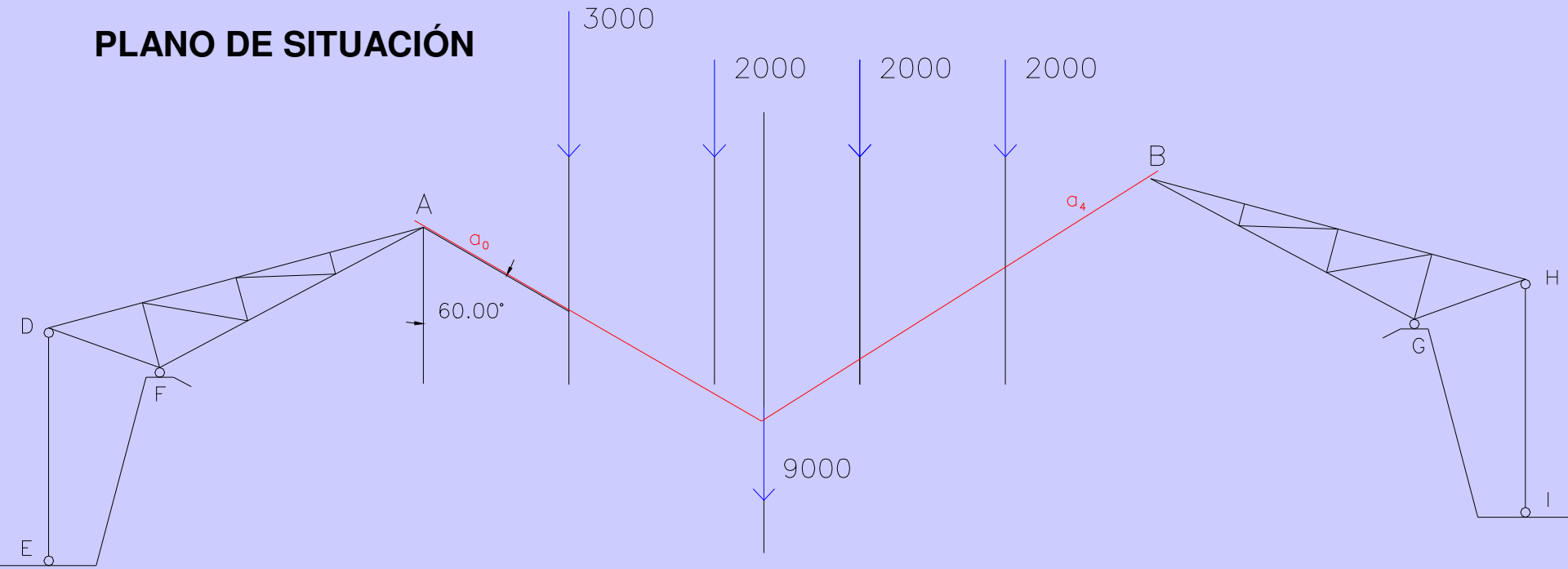

FUNICULAR POR A Y B CUYO PRIMER LADO FORMA 60°

PLANO DE SITUACIÓN

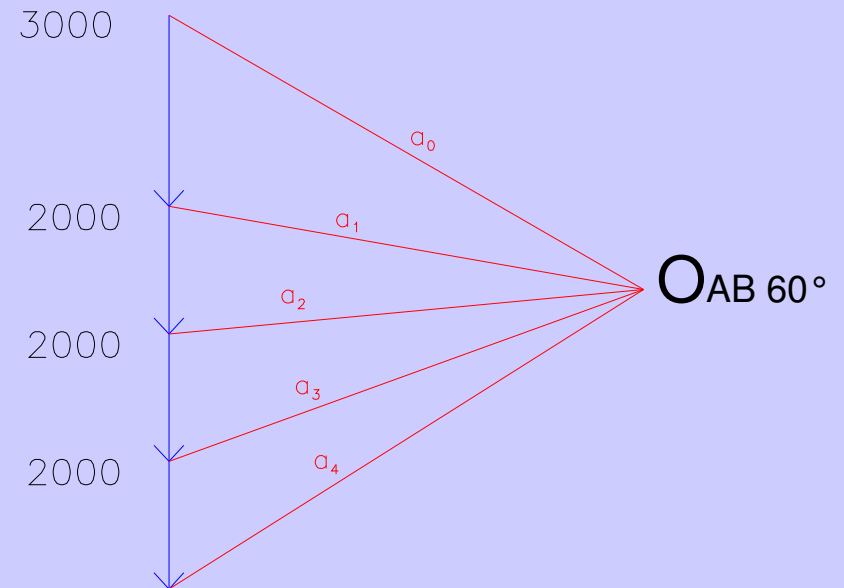
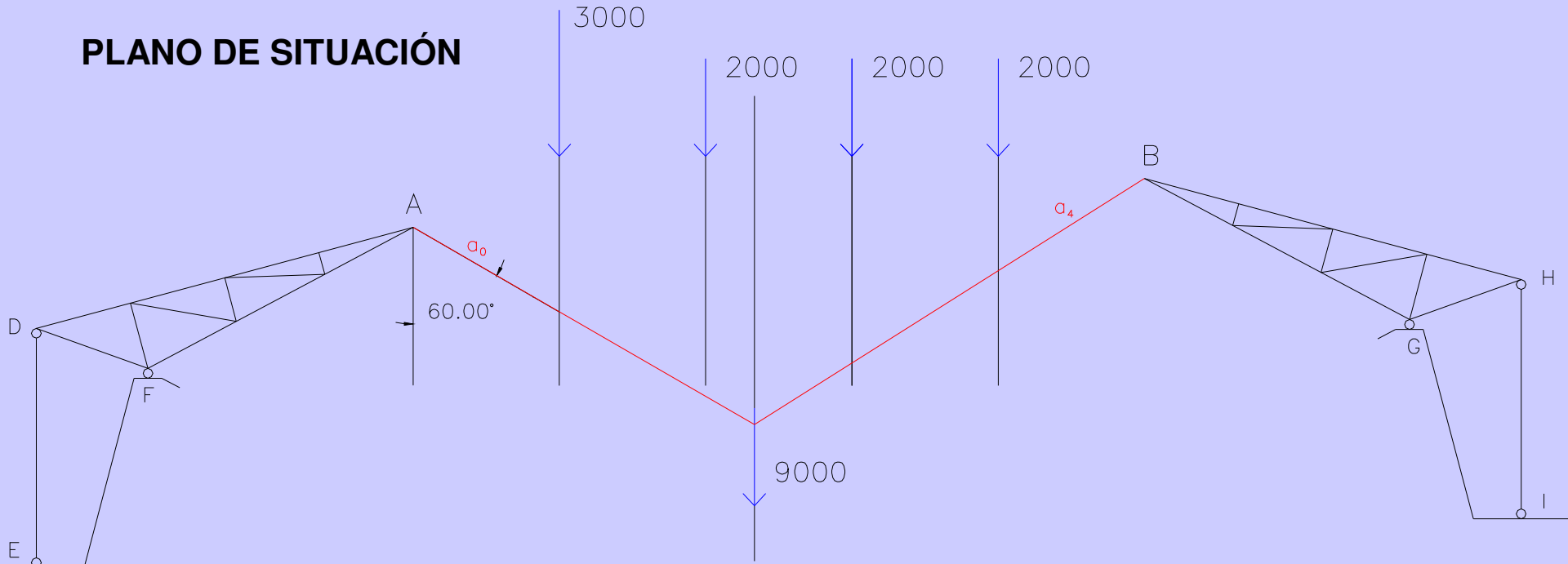

PLANO OPERATORIO

PLANO DE SITUACIÓN

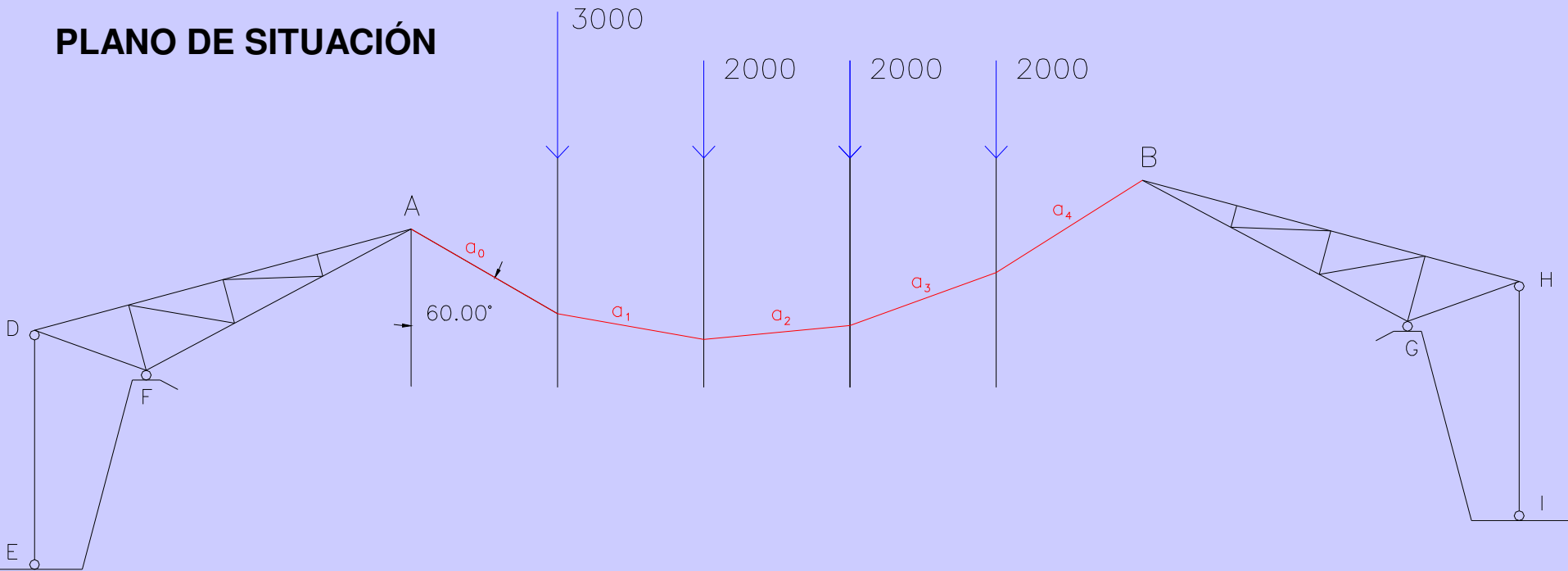

FUNICULAR POR A Y B CUYO PRIMER LADO FORMA 60°

PLANO DE SITUACIÓN

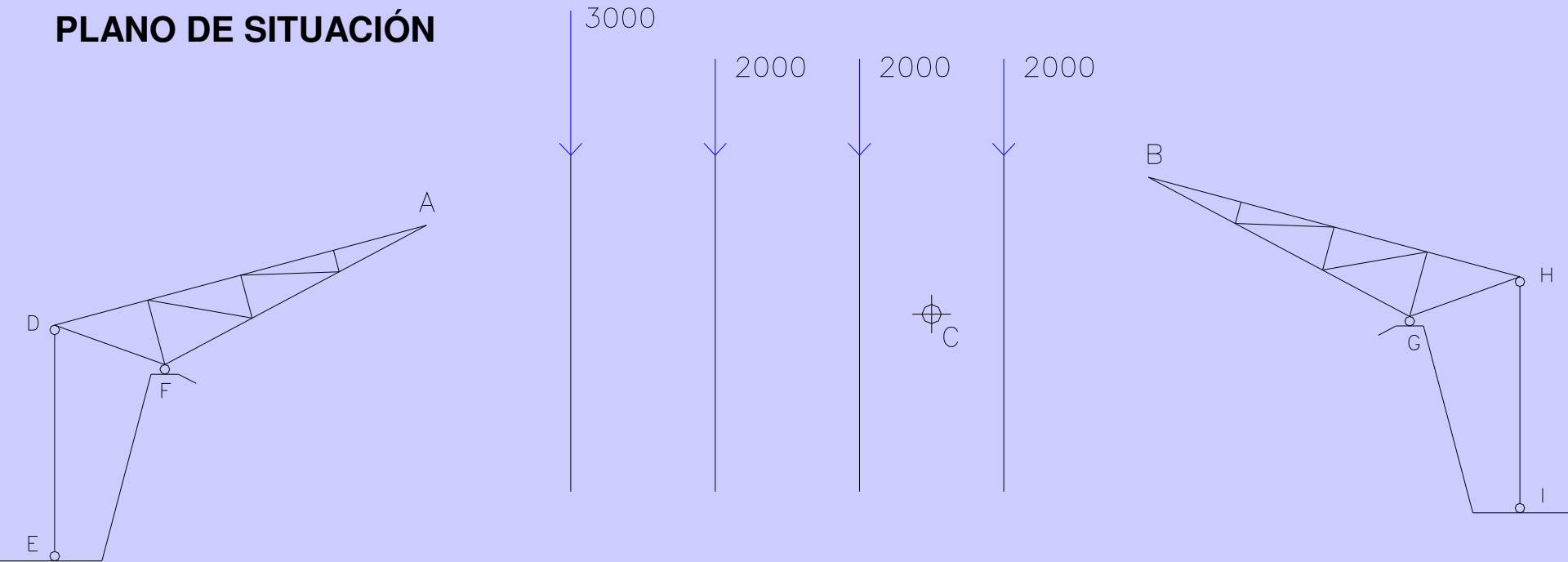

**TRAZO UNA FUNICULAR
CUALQUIERA PARA
HALLAR RESULTANTE
DE AC**

FUNICULAR POR 3 PUNTOS A - C - B

PLANO DE SITUACIÓN

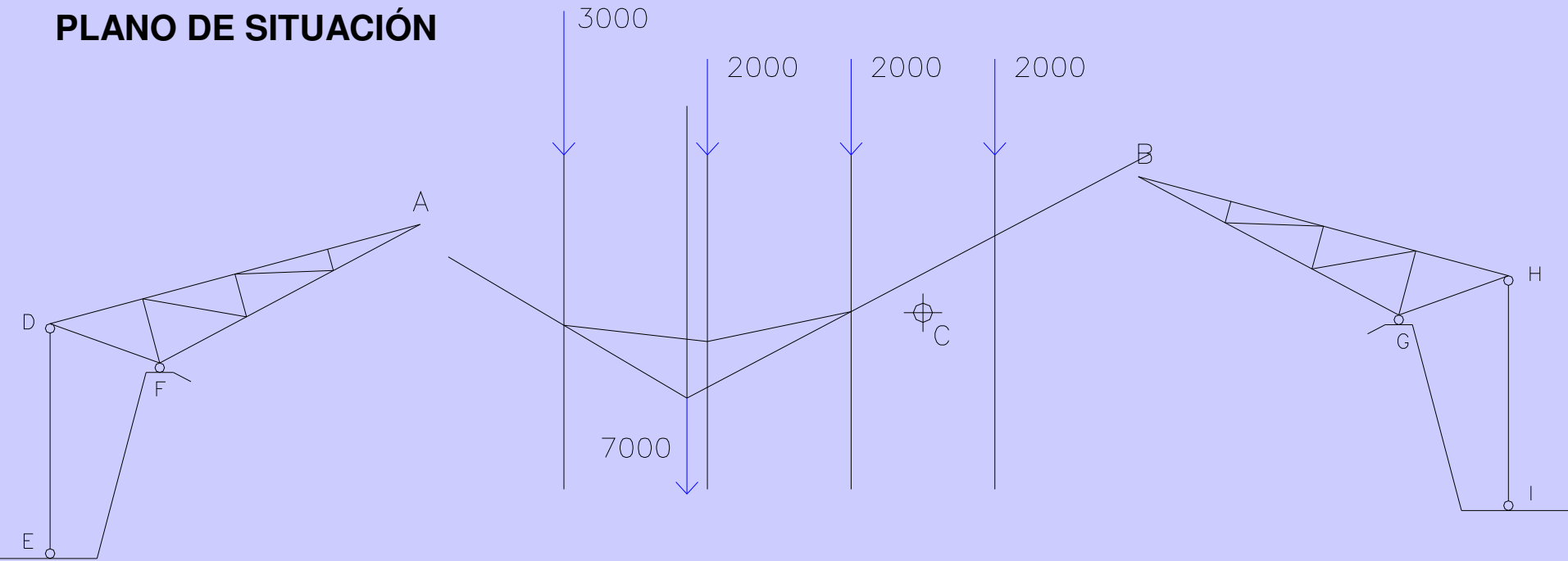

PLANO OPERATORIO

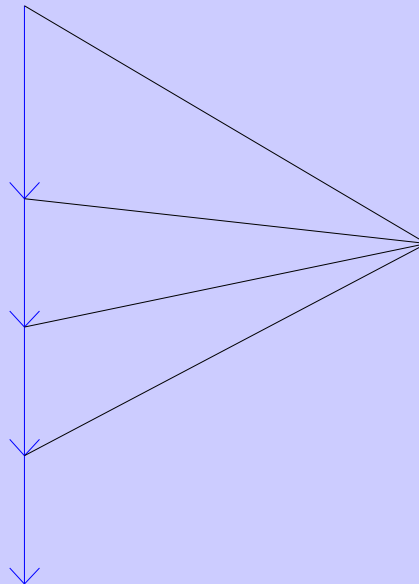

PLANO DE SITUACIÓN

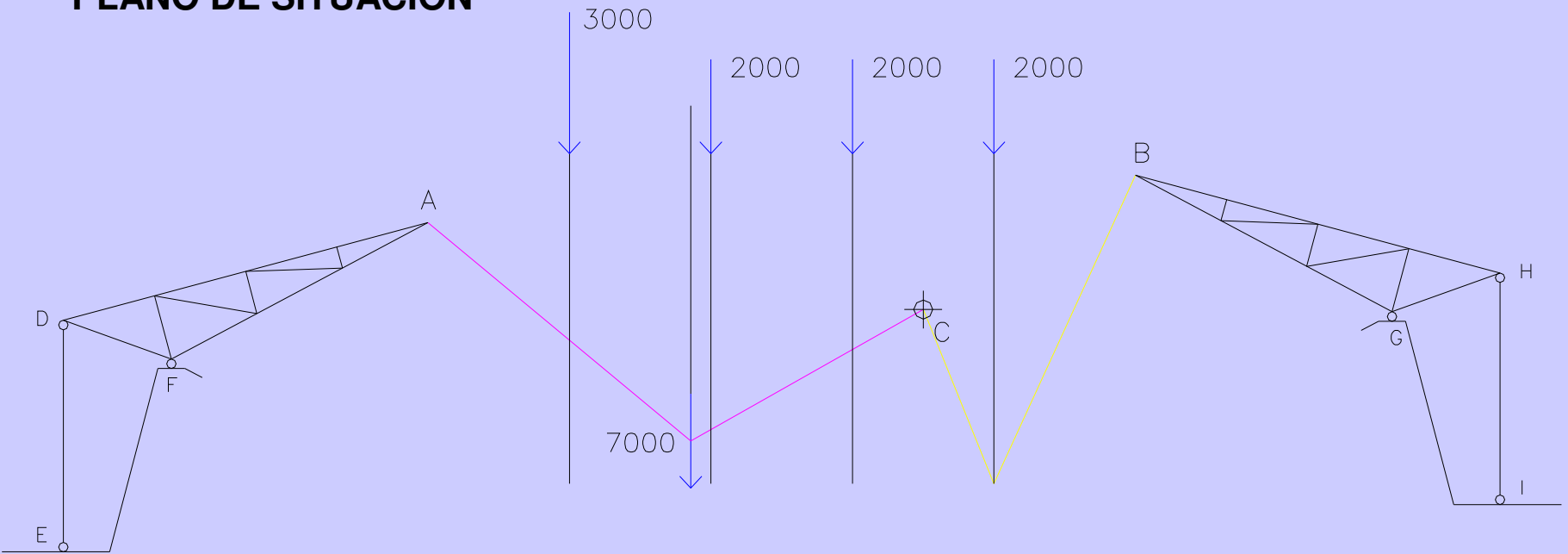

PLANO OPERATORIO

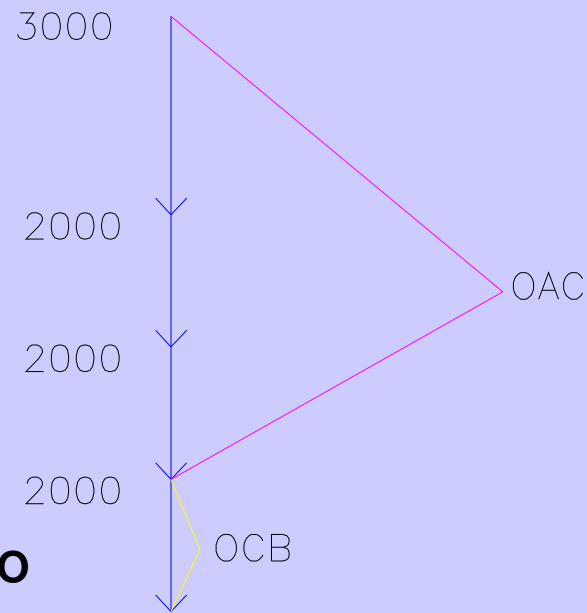

PLANO DE SITUACIÓN

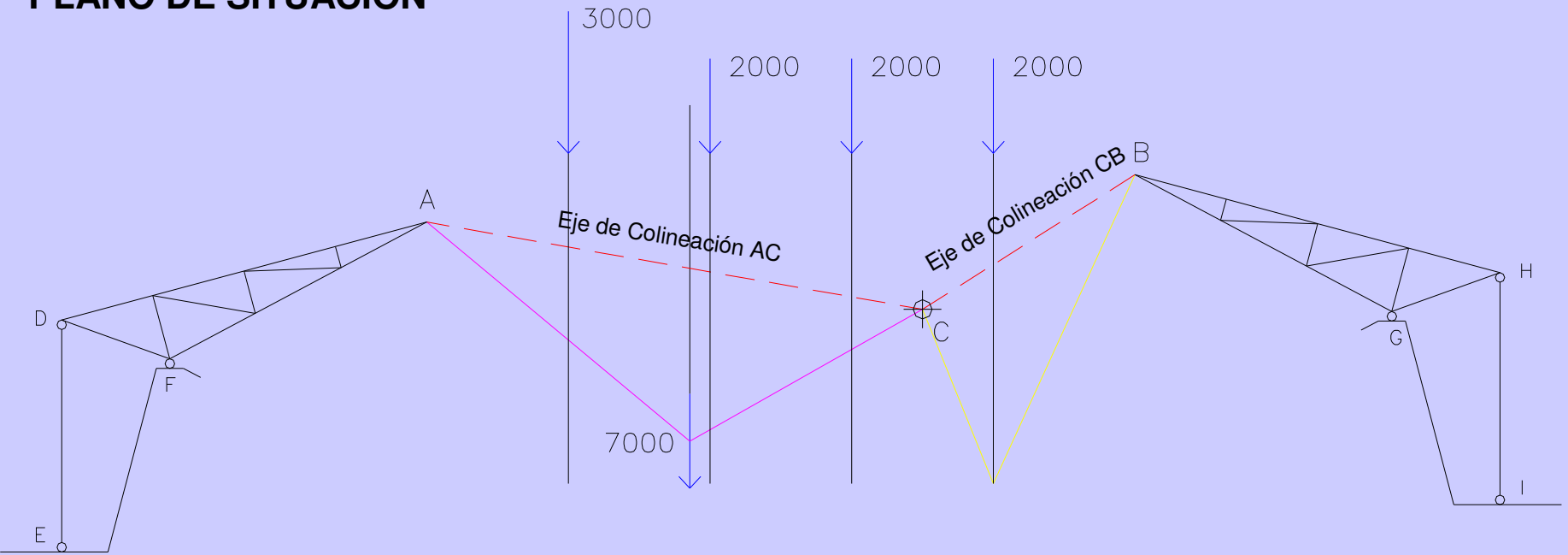

PLANO OPERATORIO

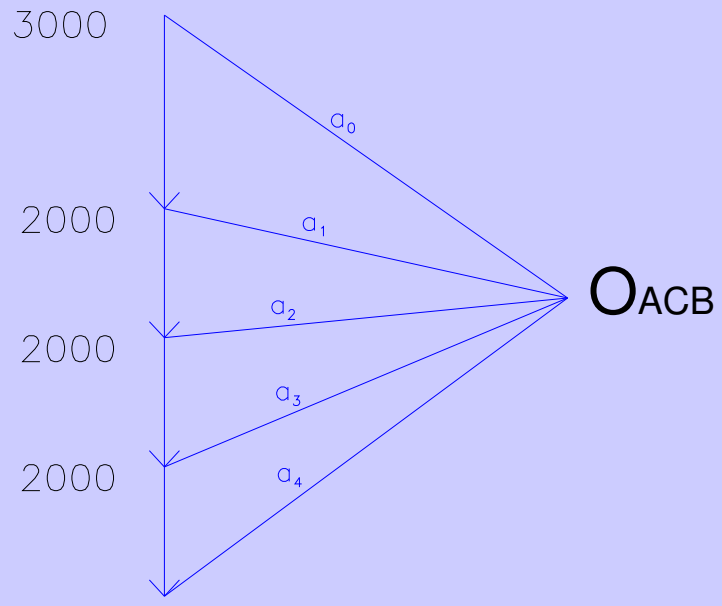
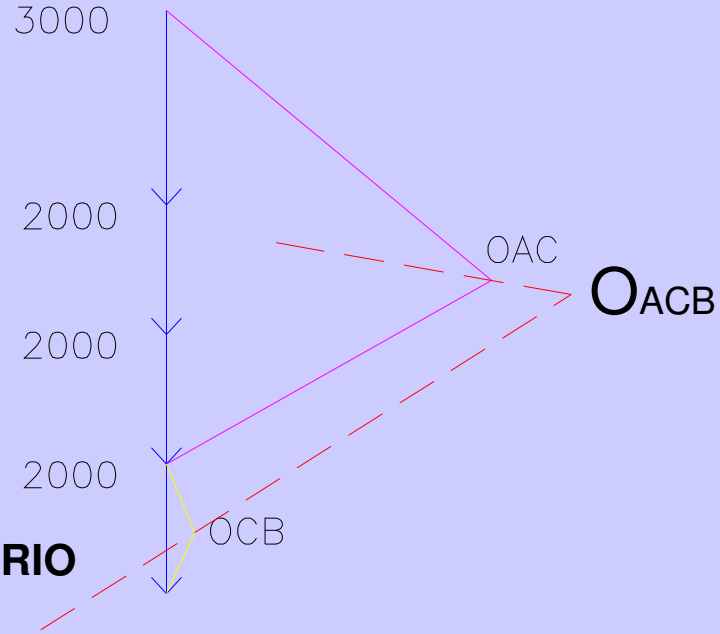

PLANO DE SITUACIÓN

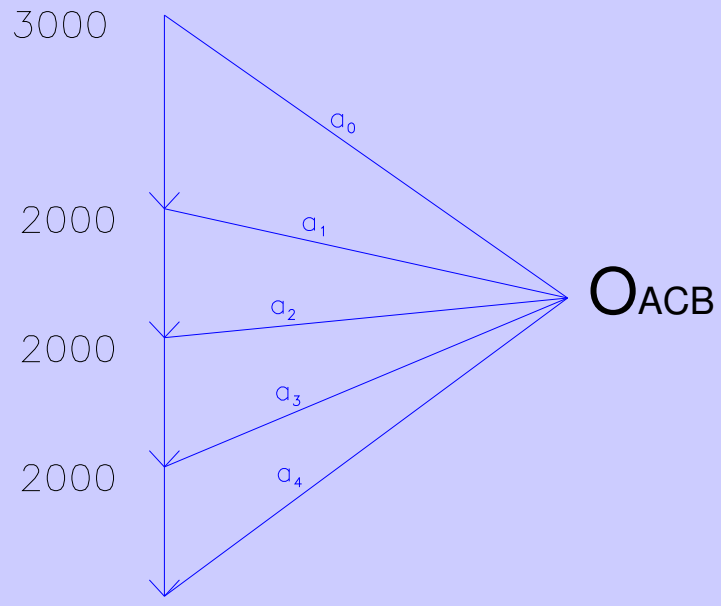
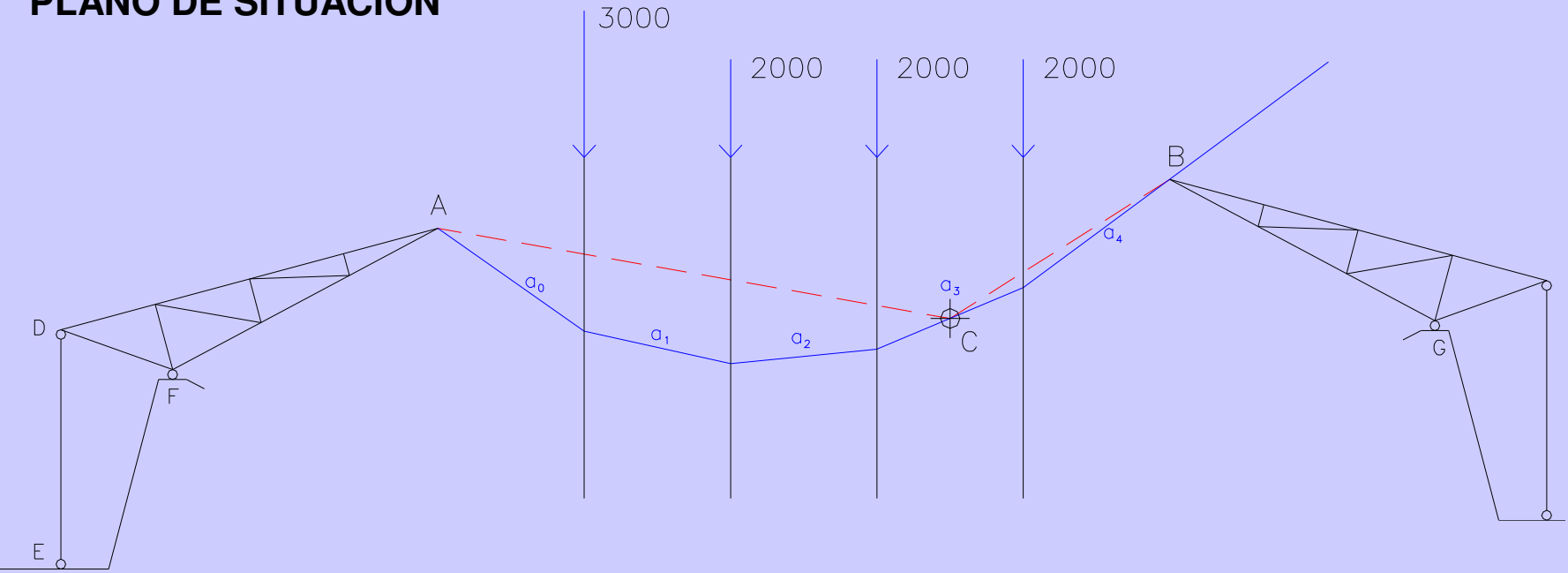

PLANO OPERATORIO

PLANO DE SITUACIÓN

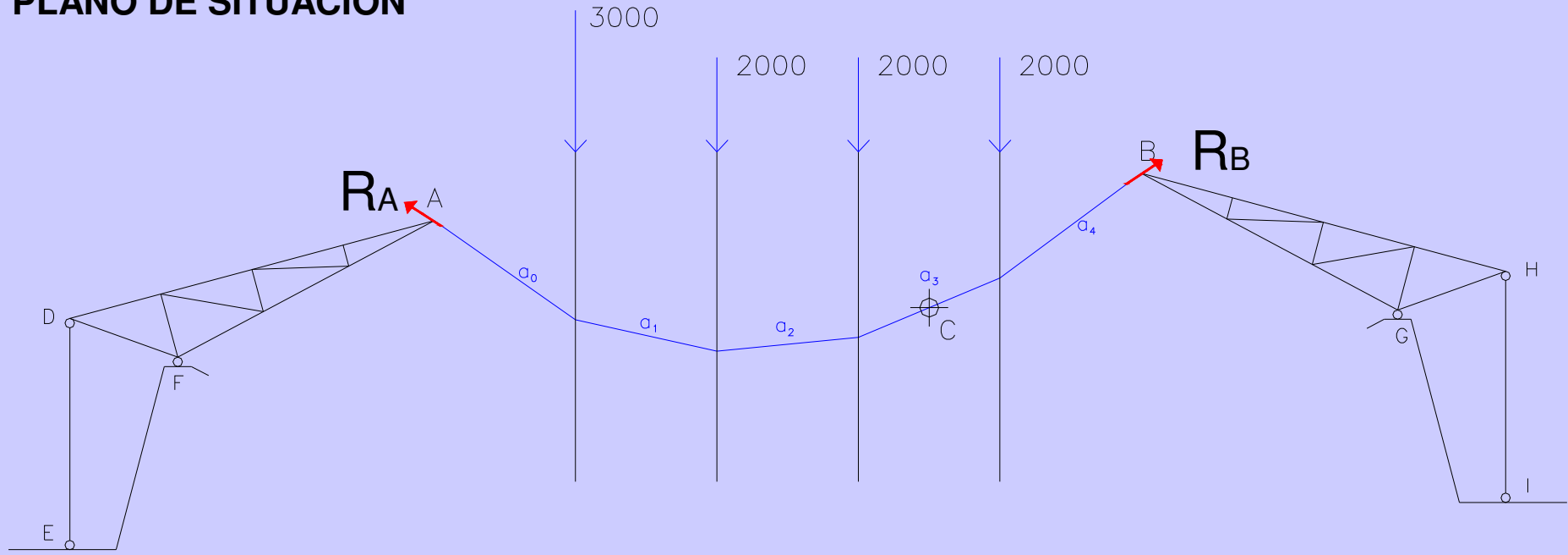

$R_{ACC} = 9000 \text{ daN}$

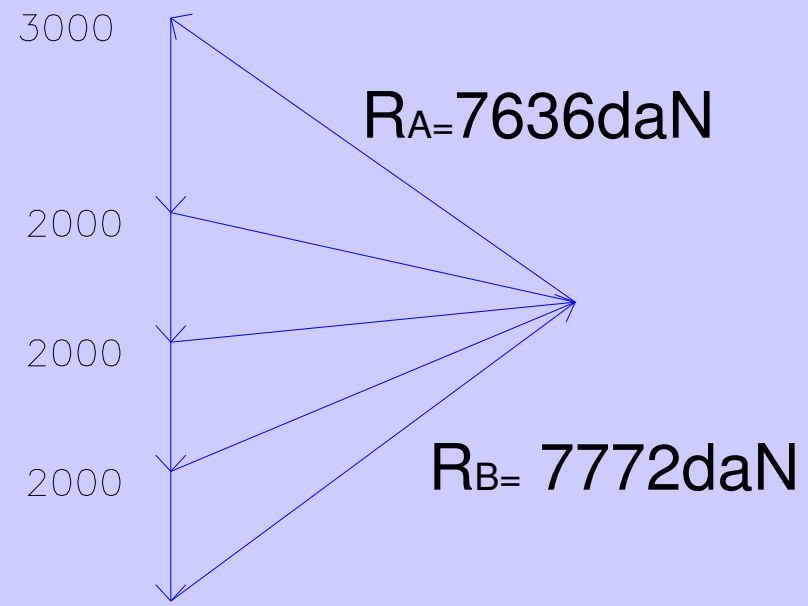

PLANO OPERATORIO